

MAX25615 Evaluation Kit

Evaluates: MAX25615

General Description

The MAX25615 evaluation kit (EV kit) demonstrates inverting, noninverting, and differential operating modes for the MAX25615 MOSFET driver. The EV kit includes one MOSFET driver, a MOSFET, and component pads for optional loads. The EV kit is fully assembled and tested.

Benefits and Features

- +4V to +16V Single Power-Supply Range
- 7A Peak Sink Current
- 3A Peak Source Current
- Inverting and Noninverting Inputs
- Proven PCB Layout
- Fully Assembled and Tested

Quick Start

Required Equipment

- MAX25615 EV Kit
- Variable 20V Power Supply
- Oscilloscope
- Function Generator

[Ordering Information](#) appears at end of data sheet.

Procedure

The EV kit is fully assembled and tested. Follow the steps below to verify board operation. **Caution:** Do not turn on the power supply until all connections are completed.

- 1) Preset the power supply to 12V. Turn off the power supply.
- 2) Preset the function generator to go from 0V to 3V at 100kHz with a 50% duty cycle. Turn off the function generator.
- 3) Connect the positive lead of the power supply to the red VINP banana jack (J4). Connect the negative lead of the power supply to the black GND banana jack (J5).
- 4) Connect the function generator output using a BNC cable to LD3.
- 5) Connect a scope probe to IN+ by using J1 and a scope probe to OUT by using J3.
- 6) Turn on the power supply.
- 7) Verify that the voltage across VINP and GND is 12V.
- 8) Turn on the function generator.
- 9) Verify on the scope that IN+ is a 0 to 3V signal at 100kHz with a 50% duty cycle and that OUT is a 0V to 12V signal at 100kHz with a 50% duty cycle with a slight phase delay with regards to IN+.
- 10) Turn off the function generator.
- 11) Turn off the power supply.

Detailed Description of Hardware

Input Configuration

The MAX25615 EV kit can use inverting, noninverting, and differential inputs. [Table 1](#) summarizes the stuffing options for each configuration. R1 and R2 are present to terminate the input lines. Parallel capacitors C5 and C12 are normally open, but can be stuffed to filter the inputs.

PRELIMINARY

Load Configurations

The MAX25615 drives a standard pinout N-channel MOSFET. The MOSFET's drain current can be directed to a resistive or LED load, which are common applications for the driver. R7 and C14 are normally open, but can be stuffed to simplify evaluation of the MAX25615 at specific load resistance and capacitance.

Rise and Fall Time Control

The MAX25615 EV kit has additional components that allow adjustment of the output rise and fall times. R5 and R6 are normally 0Ω , but can be asymmetrically stuffed with low value resistors to adjust the rise and fall times at Q1's gate.

Table 1. Input Configuration Options

COMPONENT	INVERTING INPUT	NONINVERTING INPUT	DIFFERENTIAL INPUT
Function Generator	LD4	LD3	LD3 and LD4
R1	Open	50Ω	50Ω
R2	50Ω	0Ω	50Ω
R3	0Ω	Open	Open
C5	Open	Optional	Optional
C12	Optional	Open	Open
Q1	NFET	NFET	NFET

Ordering Information

PART	TYPE
MAX25615EVKIT#	EV Kit

#Denotes RoHS compliant.

PRELIMINARY

MAX25615 EV Kit Bill of Materials

PART	QTY	DESCRIPTION
C1, C2, C3, C4	4	47 μ F 10V tantalum capacitors
C6, C8	2	0.1 μ F 25V X7R ceramic capacitors (0402)
C9	1	1 μ F 10V X5R ceramic capacitor (0402)
C10, C13	2	4.7 μ F 25V X5R ceramic capacitors (0603)
C11	1	0.01 μ F 50V X7R ceramic capacitor (0402)
C14	1	0.001 μ F 100V X7R ceramic capacitor (0603)
C16, C18	2	22 μ F 400V aluminum capacitors
C5, C12	2	Optional filter capacitors
L1	1	1A ferrite bead (0603)
LD3, LD4	2	BNC female connectors
Q1	1	N-channel MOSFET
R1	1	49.9 Ω 0.1% resistor (2512)
R2	1	0.001 Ω 1% resistor (2512)
R4	1	49.9 Ω 0.1% resistor (2512)
R5, R6	2	0 Ω 0% resistors (0201)
R7	1	Optional load resistor (1206)
TAL1	1	Pin receptacle
U1	1	7A sink, 3A source, 12ns, SOT23 MOSFET driver
---	1	PCB: MAX25615 EV kit

PRELIMINARY

MAX25615 EV Kit Schematic

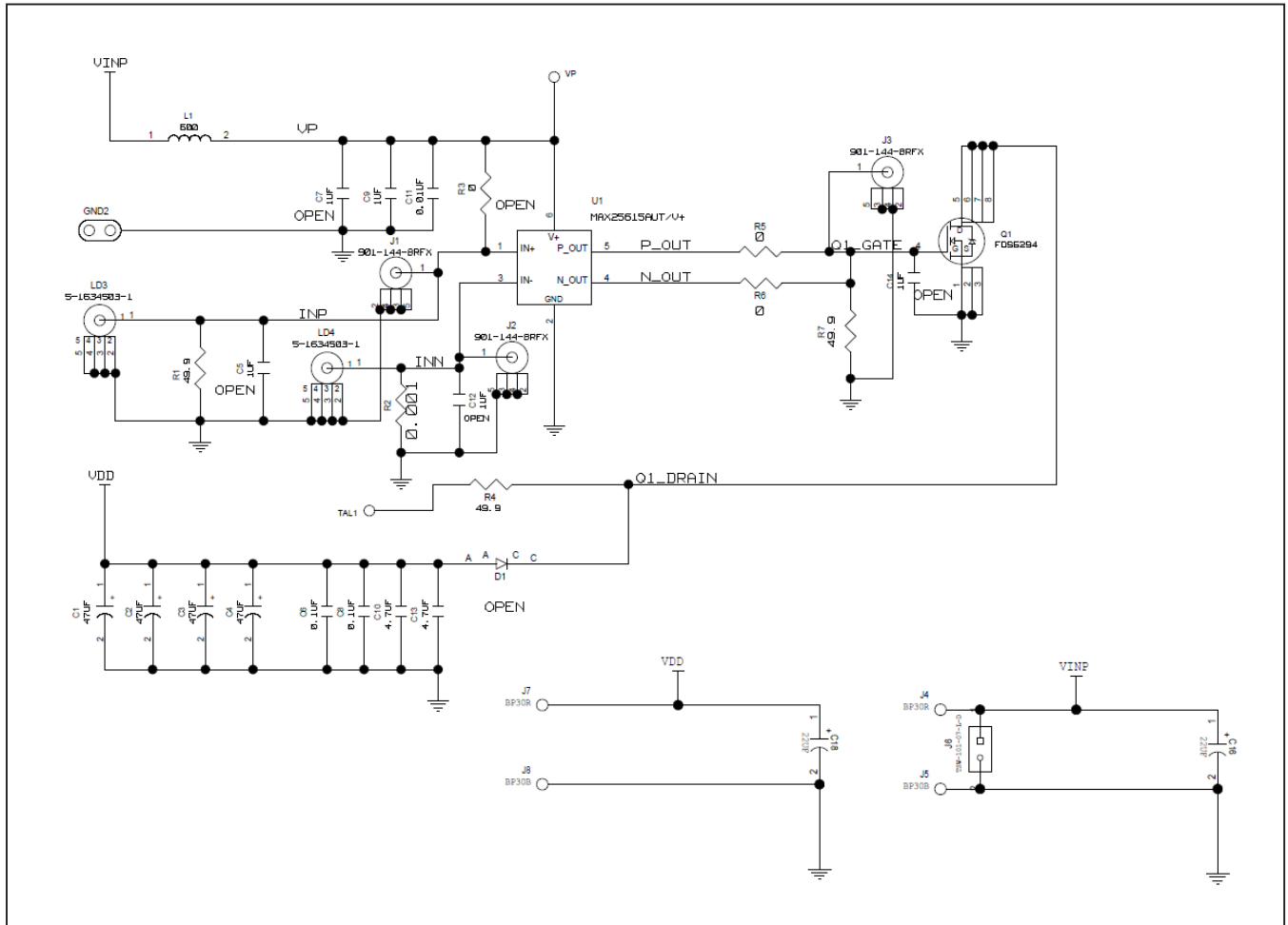

PRELIMINARY

MAX25615 EV Kit PCB Layouts

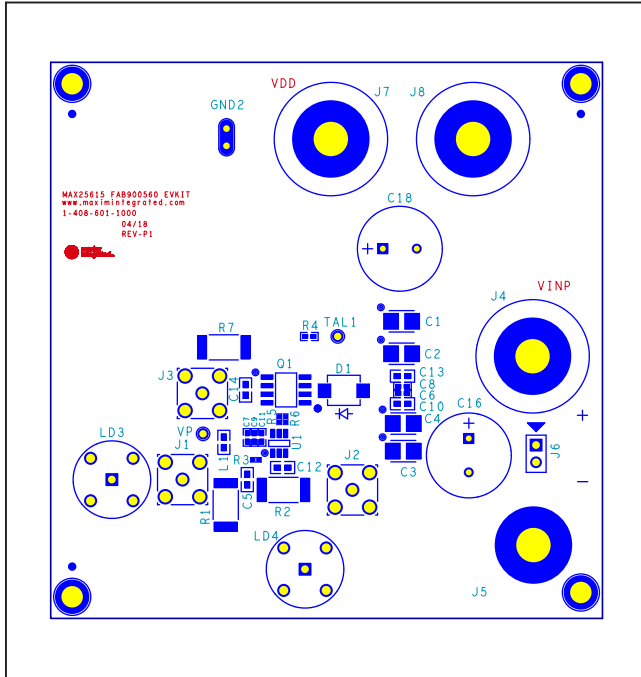

MAX25615 EV Kit Component Placement Guide—Top

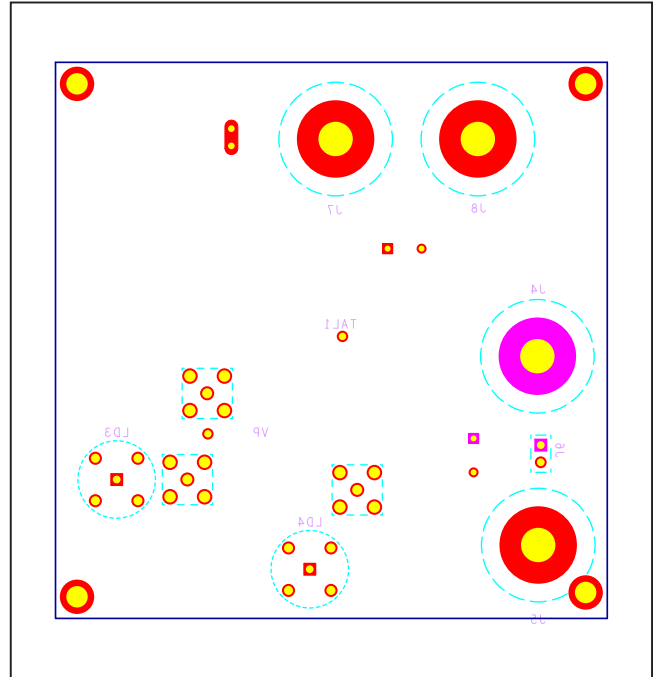

MAX25615 EV Kit Component Placement Guide—Bottom

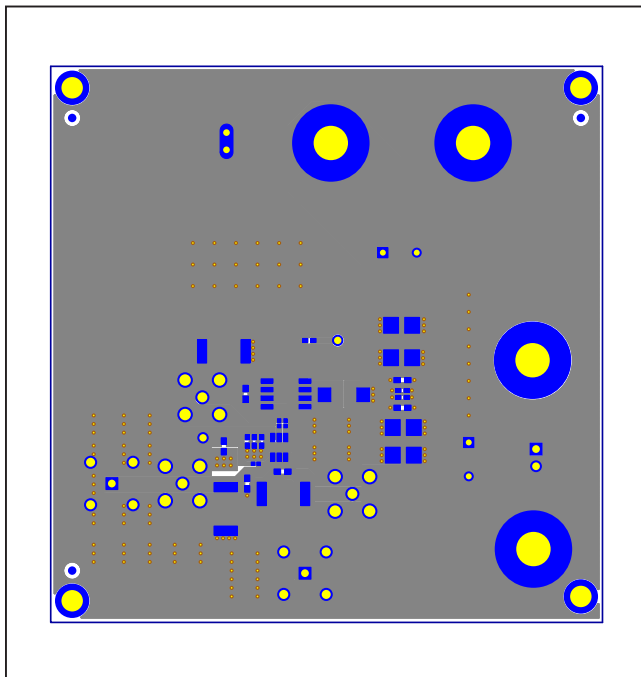

MAX25615 EV Kit PCB Layout—Solder Side Top

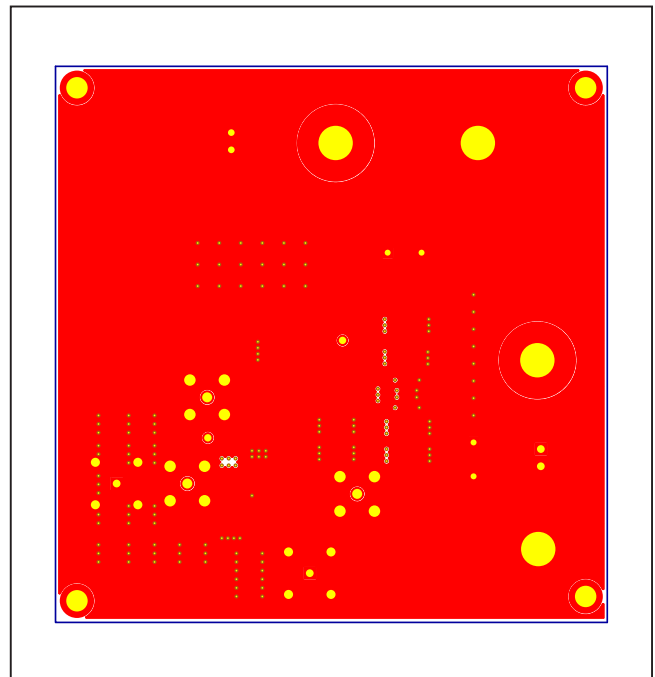

MAX25615 EV Kit PCB Layout—Solder Side Bottom

PRELIMINARY

MAX25615 EV Kit PCB Layouts (continued)

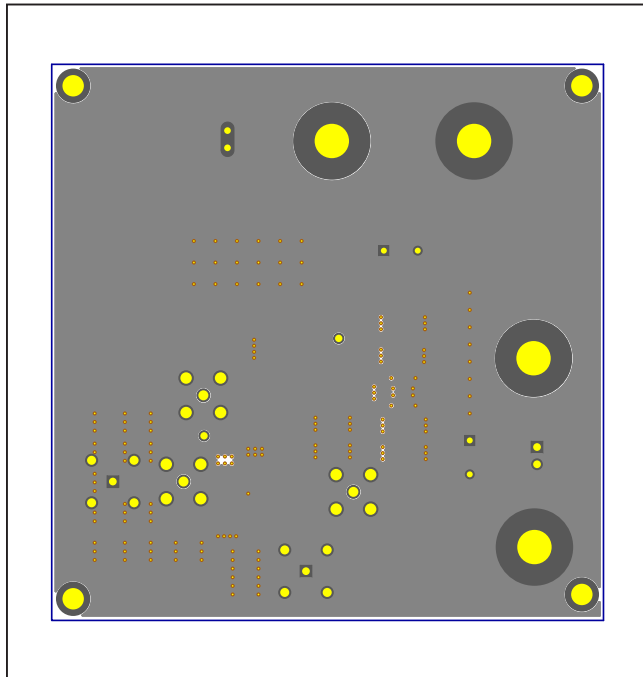

MAX25615 EV Kit PCB Layout—Internal 2

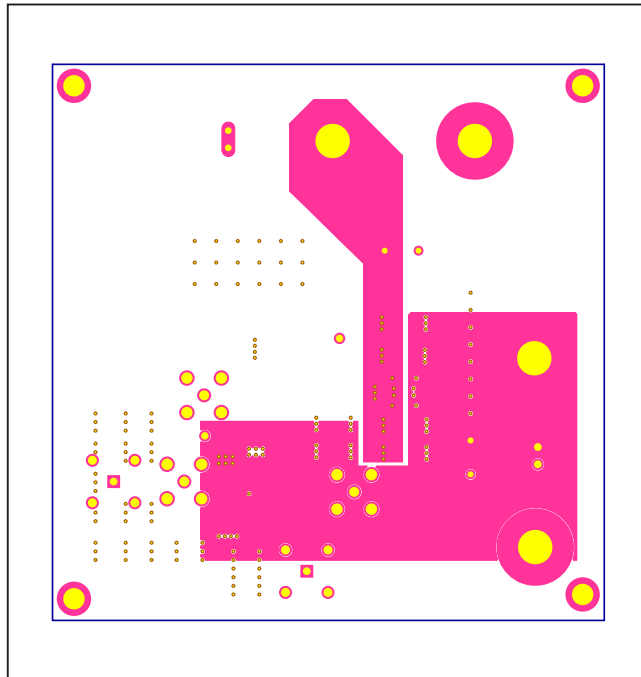

MAX25615 EV Kit PCB Layout—Internal 3

PRELIMINARY

Revision History

REVISION NUMBER	REVISION DATE	DESCRIPTION	PAGES CHANGED
0	4/19	Initial release	—

PRELIMINARY

For pricing, delivery, and ordering information, please visit Maxim Integrated's online storefront at <https://www.maximintegrated.com/en/storefront/storefront.html>.

Maxim Integrated cannot assume responsibility for use of any circuitry other than circuitry entirely embodied in a Maxim Integrated product. No circuit patent licenses are implied. Maxim Integrated reserves the right to change the circuitry and specifications without notice at any time.