

Datasheet

RS Pro 1/2in Coolant 90° Nozzle Kit Contains 1/2 in, 1/4, 3/8, Spray Bar Nozzle

RS Stock No: **623-5353**



Product Details

RS Pro 1/2 Inch 90° coolant nozzle kit is made of POM copolymer and comes with four piece. It consists of 1/2 Inch, 1/4 Inch and 3/8 Inch spray bar nozzle.

Features and Benefits

- 4-piece nozzle kit
- Made of POM polymer
- Measures 1/2 Inch

Specifications:

Kit Contents	Nozzles
Material	Acetal Copolymer
Systems	1/2 in
Type	90° Nozzle Kit

Round Nozzles

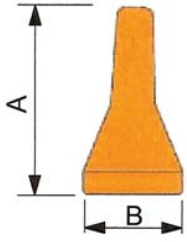
	1/4" System				1/2" System			
	Code	Type/Size	A mm	B mm	Code	Type/Size	A mm	B mm
	623-4984	Round 1/16"	30	16	623-5050	Round 1/4"	37	25
	623-4990	Round 1/8"	30	16	623-5072	Round 3/8"	37	25
	623-5000	Round 1/4"	30	16	623-5101	Round 1/2"	37	25

Flared Nozzles

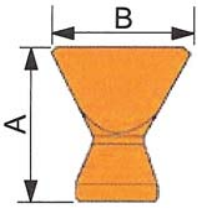
	1/4" System				1/2" System			
	Code	Type/Size	A mm	B mm	Code	Type/Size	A mm	B mm
	623-5022	Flared 1"	30	28	623-5123	Flared 1"	30	34

NPT Connectors

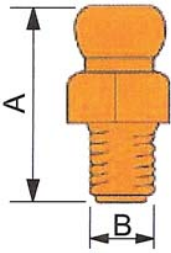
	1/4" System				1/2" System			
	Code	Type/Size	A mm	B mm	Code	Type/Size	A mm	B mm
	623-5016	1/8" NPT	26	1/8" NPT	623-5145	3/8" NPT	38	3/8" NPT
	623-5038	1/4" NPT	26	1/4" NPT	623-5167	1/2" NPT	38	1/2" NPT

Y Fittings

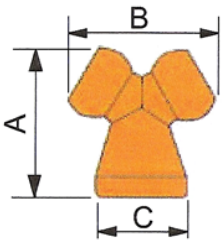
	1/4" System					1/2" System				
	Code	Type/Size	A mm	B mm	C mm	Code	Type/Size	A mm	B mm	C mm
	623-5044	1/4 Y	27	27	16	623-5117	1/2 Y	44	50	25

Straight Reducer

	1/2" System to 1/4" System			
	Code	Type/Size	A mm	B mm
	623-5139	1/2" to 1/4"	34	25

In-Line Valves

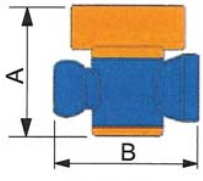
	1/4" System				1/2" System			
	Code	Type/Size	A mm	B mm	Code	Type/Size	A mm	B mm
	623-5268	1/4 In-Line	31	35	623-5375	1/2" In-Line	41	58

Male NPT Valves

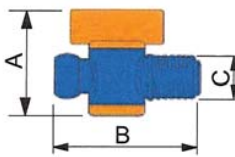
	1/4" System					1/2" System				
	Code	Type/Size	A mm	B mm	C mm	Code	Type/Size	A mm	B mm	C mm
	623-5280	1/4 NPT	31	41	1/4"NPT	623-5381	1/2" NPT	41	61	1/2" NPT

Elbow Fittings

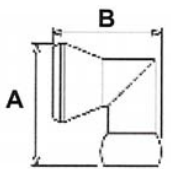
	1/4" System				1/2" System			
	Code	Type/Size	A mm	B mm	Code	Type/Size	A mm	B mm
	623-5066	1/4"	26	23	623-5381	1/2"	38	34

T Fitting

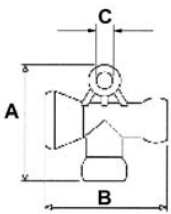
	1/4" System					1/2" System				
	Code	Type/Size	A mm	B mm	C mm	Code	Type/Size	A mm	B mm	C mm
	623-5274	1/4 T	32	34	4.75	623-5347	1/2" T	44	48	4.75

In-Line Check Valve

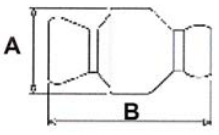
	1/4" System				1/2" System			
	Code	Type/Size	A mm	B mm	Code	Type/Size	A mm	B mm
	623-5246	1/4" Non Return Valve	21	41	623-5369	1/2" Non Return Valve	24	47.5

Metal Ball Valves

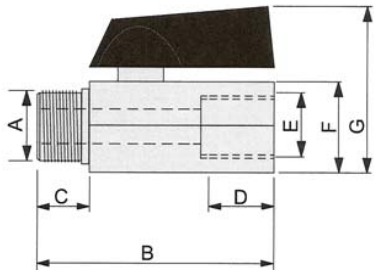

Suitable for domestic water services, heating, air conditioning plants and compressed air systems
 Minimum Working Temperature: 0°C
 Maximum Working Temperature: 90°C
 Valve body manufactured from brass with a bright chrome finish

Code	A mm	B mm	C mm	D mm	E mm	F mm	G mm
623-5202	1/8" NPT	35	9	9	1/8" NPT	20	35
623-5224	1/4" NPT	40	12	12	1/4" NPT	20	35
623-5173	3/8" NPT	40	12	12	3/8" NPT	20	35
623-5195	1/2" NPT	45	12	12	1/2" NPT	25	42

90° Nozzle Kit

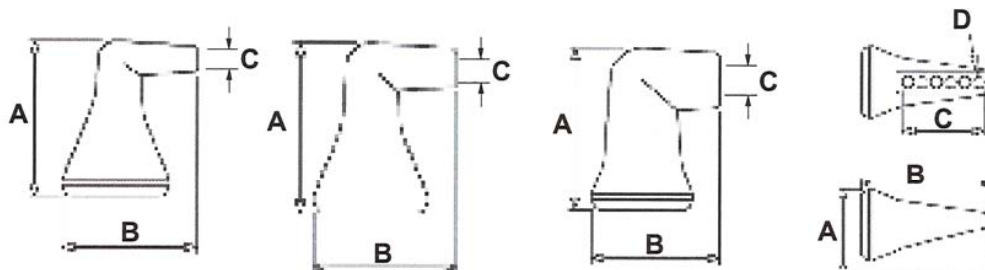

SMALL **MEDIUM** **LARGE** **SPRAY BAR**

1/4" System: Code: 623-5296				1/2" System: Code: 623-5353					
Description	A mm	B mm	C mm	Description	A mm	B mm	C mm		
1/4" x 90° Nozzle: Small	25	20	1.9	1/2" x 90° Nozzle: Small	30	36	6.8		
1/4" x 90° Nozzle: Medium	25	20	3.6	1/2" x 90° Nozzle: Medium	30	37	9.5		
1/4" x 90° Nozzle: Large	25	20	6.1	1/2" x 90° Nozzle: Large	30	39	12.5		
Description	A mm	B mm	C mm	D mm	Description	A mm	B mm	C mm	D mm
1/4" Spray Bar	19	30	19	2.3	1/2" Spray Bar	31	57	43	4.2

Circular Flow Assembly

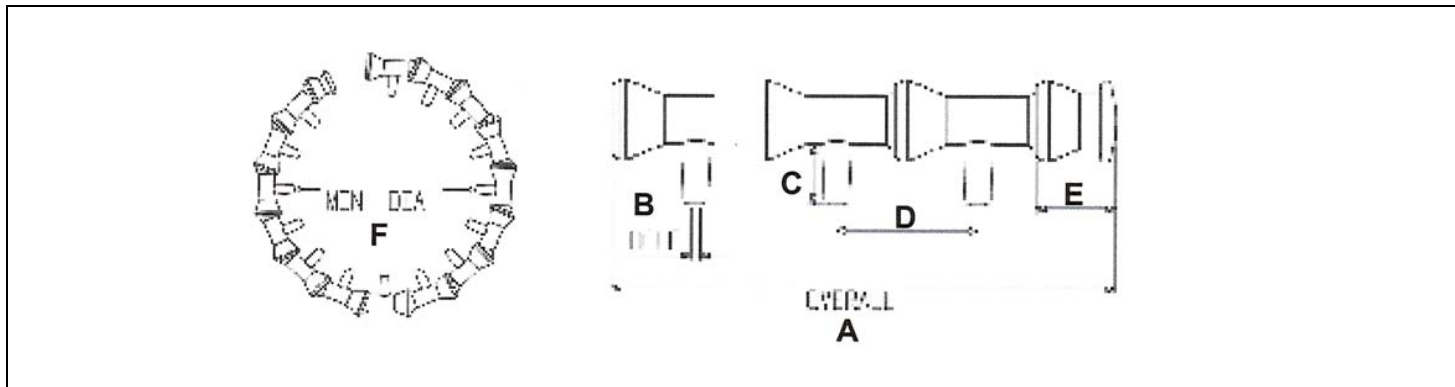

1/4" System: Code: 623-5230

Description	A mm	B mm	C mm	D mm	E mm	F mm
1/4" Assembly	434	1.9	11	28	17	110

1/2" System: Code: 623-5331

Description	A mm	B mm	C mm	D mm	E mm	F mm
1/2" Assembly	605	3.36	12	38	20	165

Manifold Set

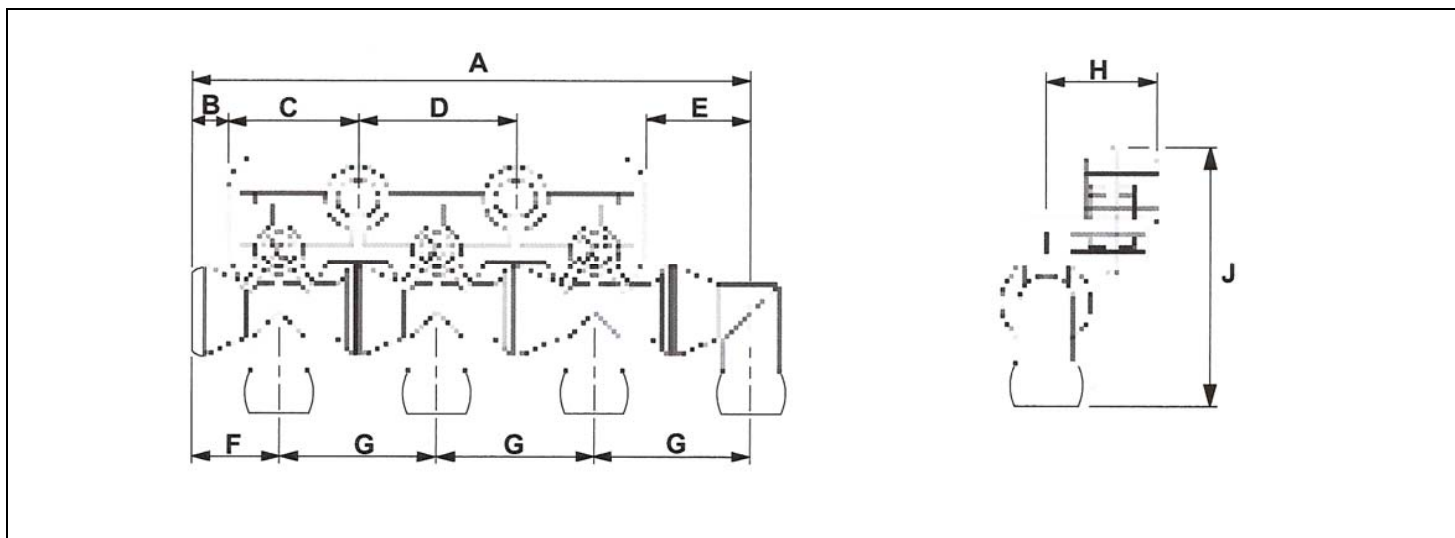

Code	Description	A mm	B mm	C mm	D mm	E mm	F mm	G mm	H mm	J mm
623-5303	1/4" Manifold System	102	86	23	28	20	17	28	20	44