

Datasheet

Square Tube

Versatile Construction System



- Easily build custom items to your design
- 25mm steel square tube or aluminium
- 7 right angle connecting joints for full design flexibility
- Simply cut tube to length and tap together
- Wide range of accessories available

It's so easy



DATA SHEET

CUSTOM designed solutions

A versatile system suitable for the construction of items such as workstations, benches and trolleys.

joints



One-piece joints are supplied ready for use. Available as Plastic outer with Steel core, in Black (BK) or as plastic only in Light Grey (GY). 6 way joint not available in Grey.



plain & perforated tube

25mm square tube available plain or perforated on one or two sides with 20mm x 3mm slots positioned on 50mm pitch. Choose from 18swg cold rolled seam welded steel or Extruded aluminium alloy.

Steel available in BLACK, RED, BLUE, LIGHT GREY - Double coat painted and stove enamelled, BRIGHT CHROME - Electroplated or ZINC PLATED - Clear passivated.

Aluminium is either self coloured or black powder coated.

single finned tube

Extruded aluminium tube, self colour or black powder coated finish. The fin provides a continuous support for either 15mm board or 6mm glass.



double finned tube

Extruded aluminium tube available in different configurations, self colour or black powder coated finish. Enables 15mm board to be used as cladding directly onto the tube.

feet and castors

Adjustable Foot

Black plastic foot including cap, for steel or aluminium.

Metal Cap

Bright steel. Used as load-bearing feet.

Plastic Cap

Black cap for open ends of tube and as light duty foot.

Horizontal Ferrule

Plastic end cap to raise tube clear of floor obstructions.

Light or Medium Duty Castors

Choice of duties offering load capacities of 113 or 180kg per set of four.

Light Duty Wheel

100mm dia. chrome body, grey wheel with rubber tyre. Load per set of four 160kg.

Baseplates

Used for fixing structures to floors, walls or ceilings.

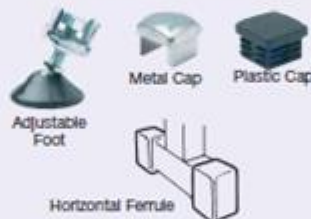

clips

BENCH OR TROLLEY CLIP

Secures surface board to a tube framework.



SHELF CLIP For 15mm thick shelving.



INVISIBLE SHELF CLIP For perforated tube, to provide hidden shelf support.



ADJUSTABLE SHELF CLIP For perforated tube.



cantilever shelving arms

Used with perforated tube to provide a fully adjustable shelf support.















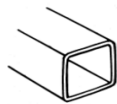
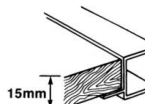
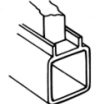
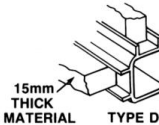
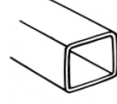
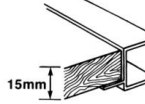
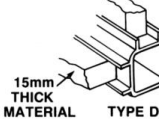



tools

Cutting Jig

Assists in accurate cutting of tube by hand saw.



358-2785	Black Steel Square Tube, 3m L 25 X 25mm	
358-2808	Red Steel Square Tube, 3m L 25 X 25mm	
358-2791	Blue Steel Square Tube, 3m L 25 X 25mm	
436-796	Black Slotted Steel Square Tube, 2m L 25 X 25mm	
519-071	Anodised Plain Aluminium Square Tube 25 x 25mm	 PLAIN TUBE
519-087	Anodised Single Fin Aluminium Square Tube 25 x 25mm	 SINGLE FIN
519-093	Anodised 2 Fin 1 Side Aluminium Square Tube 25 x 25mm	 TYPE A
519-100	Anodised 2 Fin 2 Side Aluminium Square Tube 25 x 25mm	 15mm THICK MATERIAL TYPE D
436-724	Black Plain Aluminium Square Tube 25 x 25mm	 PLAIN TUBE
436-730	Black 2 Fin 1 Side Aluminium Square Tube 25 x 25mm	 SINGLE FIN
436-746	Black 2 Fin 2 Side Aluminium Square Tube 25 x 25mm	 15mm THICK MATERIAL TYPE D

621-691	Black 2 Way Square Tube Connector	
621-708	Black 3 Way Square Tube Connector	
621-714	Black 3 Way Square Tube Connector	
621-720	Black 4 Way Square Tube Connector	
621-736	Black 4 Way Square Tube Connector	
621-742	Black 5 Way Square Tube Connector	
621-758	Black 6 Way Square Tube Connector	
621-792	Black Shelf Clip for Square Tube System	
436-780	Blue Shelf Clip for Square Tube System	
436-803	Slotted Adjustable Shelf Clip	
436-819	Slotted Invisible Shelf Clip	

621-809	Bench Clip for Square Tube System	
621-764	Black Plastic End Caps for Square Tube System	
519-116	Nylon Wheel for Square Tube System, 100mm Diameter	
519-122	Nylon Wheel with Brake for Square Tube System, 100mm Diameter	
621-770	Adjustable Feet for Square Tube System, 40kg per foot	
621-786	Castor for Square Tube System, 28kg per wheel, 50mm Diameter	
621-815	Cutting Jig for Square Tube System	



ENGLISH

Tube Connecting Joints

Material

Unique formula, comprising Nylon 6 base material, glass-filled fibre strand and an impact modifier. Joints are injection moulded and comprise a central solid core and hollow right angle arms.

Finish

Smooth satin finish in black.

Features

- Impact resistant plastic joint
- The range of seven connecting joints provide all the right angle configurations for the assembly of tube structures
- The tube cut lengths are tapped into place over the arms leaving only the 25mm square core of the joint visible
- Joints are single piece components, ready for immediate use, and do not require the fitting of inserts or other parts
- Manufactured to a quality management system conforming to ISO 9001

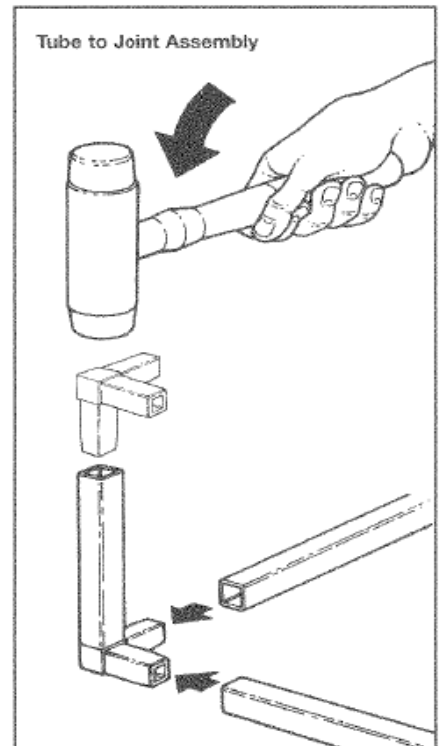
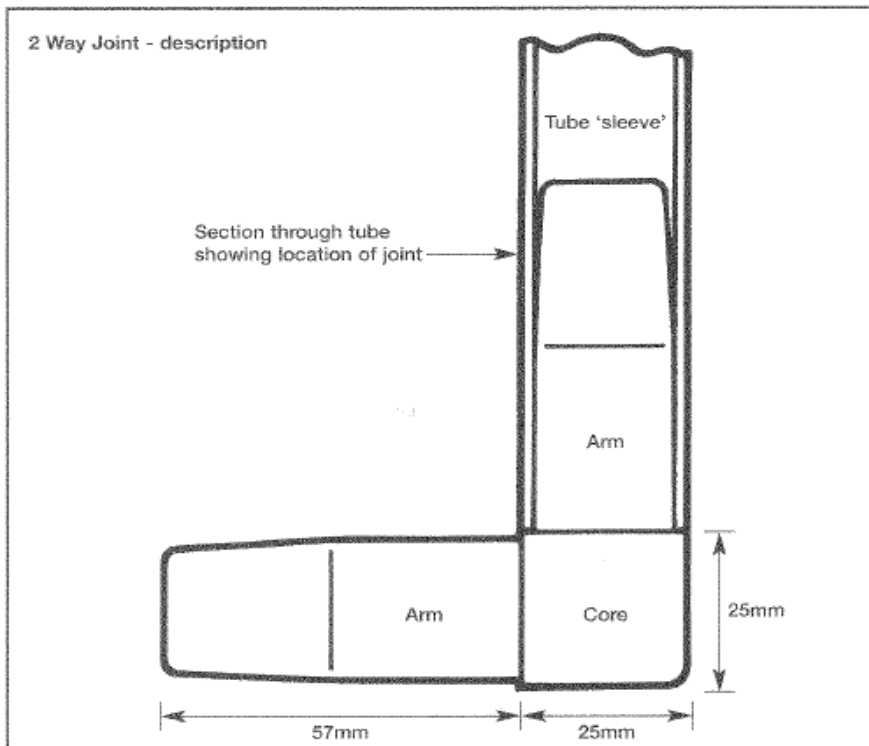
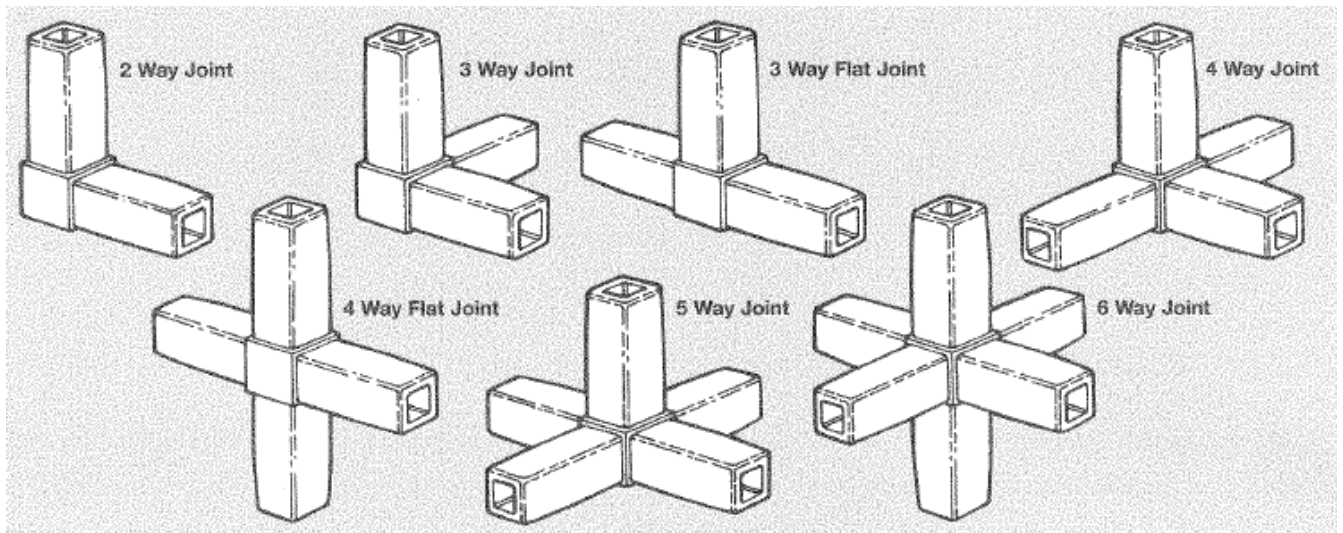

Upright & Beam Loads

- When designing tube structures - shelving in particular - care should be taken to ensure that the structure will safely support the anticipated loads.
- Reference should be made to the load tables below to ensure that the load bearing capacity of Tube uprights and beams is not exceeded. Where load bearing is a critical aspect of the design, shorter beams and uprights should be incorporated.

- Loads quoted are for maximum safe uniformly distributed loads - i.e. where the load is evenly distributed across the supporting shelf or surface, and distributed equally between all of the shelves or levels in a unit. Point loads should be avoided.
- As a general rule, the span between uprights supporting load-bearing shelves should not exceed 1000mm.

- Often the safe loading limitation will be imposed by the nature of the material used for shelving or cladding and care should be taken to ensure that such materials are fit to support the anticipated load.
- Steel Tube only should be used for load-bearing shelving. Aluminium Tube should be used where supported loads will be incidental or light - in display shelving, for example.

Steel Tube Loads

Loads are given for steel tube (plain or perforated) used as 'uprights' or 'beams'.

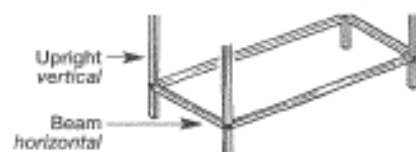

Load Table for Tube as BEAMS	
Length (span*)	Max. load per pair, kg
600mm	275
900mm	180
1200mm	110
1500mm	70
1800mm	45

Load Table for Tube as UPRIGHTS	
Length (height*)	Max. load, kg
600mm	885
900mm	660
1200mm	455
1500mm	320
1800mm	250

*Note: Sizes given as 'span' and 'height' are the length of a single section of Tube, i.e. the distance between the connecting joints.

Aluminium Tube Loads

Note: Loads are given for aluminium tube (plain or fin) used as 'uprights' or 'beams'.

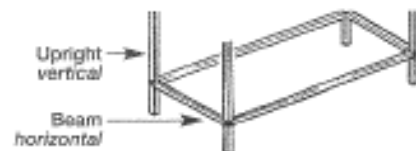

Load Table for Tube as BEAMS	
Length (span)	Max. load per pair, kg
600mm	135
900mm	65
1200mm	35
1500mm	25
1800mm	15

Load Table for Tube as UPRIGHTS	
Length (height)	Max. load, kg
600mm	440
900mm	330
1200mm	225
1500mm	160
1800mm	115

Stability Loads

- Load carrying structures - and in particular shelving units or bays - must be designed with consideration to the effects loading will have on the stability of the structure. In general, the shorter the upright lengths (and thus the less the space - or 'pitch' - between shelves) then the stronger and more stable the structure will become.
- The accompanying table gives examples of maximum load carrying capacities for Tube structures as shelving units (bays). Stability loads for intermediate heights may be interpolated from these examples.
- In all instances, the load capacity of the shelves must not exceed that of the supporting uprights.

Stability Test Loads - maximum loads for shelving bay structures		
Overall height of structure	Length of uprights/distance between joints	Max. load kg
1000mm	1000mm (top & base shelf)	270
1000mm	500mm (top, base & intermediate shelf)	380
1500mm	1500mm (top & base shelf)	180
2000mm	2000mm (top & base shelf)	155
2000mm	500mm (top, base & 3 intermediate shelves)	1000
2000mm	1000mm (top, base & intermediate shelf)	250
3000mm	1500mm (top, base & intermediate shelf)	135

- It can be seen that when heavier loads are to be supported, then the number of shelf levels should be increased and the length of the intermediate uprights reduced to increase overall stability.
- Structures with wide, deep shelves supported by tall uprights should be avoided.

Note: Stability load tests were made according to the Storage Equipment Manufacturers Association (SEMA) code of practice for 'Low-Rise Static Steel Shelving'. Steel Tube uprights were used, supporting chipboard shelves, 1000mm wide x 450mm deep, on shelf clips.