

FEATURES

- Single handed operation
- Light and compact
- Safety version
- Silicon free

RS PRO PLUG WITH REST FOR RUBBER HOSE - ITALIAN 5 mm

RS Stock No.: 2312511



RS PRO Professionally Approved Products bring to you professional quality parts across all product categories. Our product range has been tested by engineers and provides a comparable quality to the leading brands without paying a premium price.

Product Description

The RS PRO plug with rest for rubber hose-Italian 5 mm works in 0 to 16 bar pressure range. It mainly used in compressed air & tools, pneumatic & fluid technology, food & beverages. It has operating temperature range from - 20 °C + 80 °C.

General Specifications

Coupling Type	Straight
Body Material	Brass
Application	Compressed Air, Pneumatic Automation, Textile, Packaging, Handling

Mechanical Specifications

Maximum Working Pressure	16bar
Connector Gender	Male
Hose Inner Diameter	8mm
Hose Outer Diameter	12mm

Similar Products

Parameters	2312502	2312503
Brand	RS PRO	RS PRO
Coupling Type	Straight	Straight
Body Material	Brass	Brass
Maximum Working Pressure	10bar	10bar
Connector Gender	Male	Male
Hose Inner Diameter	4mm	6mm
Hose Outer Diameter	11mm	11mm
Application	Compressed Air, Pneumatic Automation, Textile, Packaging, Handling	Compressed Air, Pneumatic Automation, Textile, Packaging, Handling

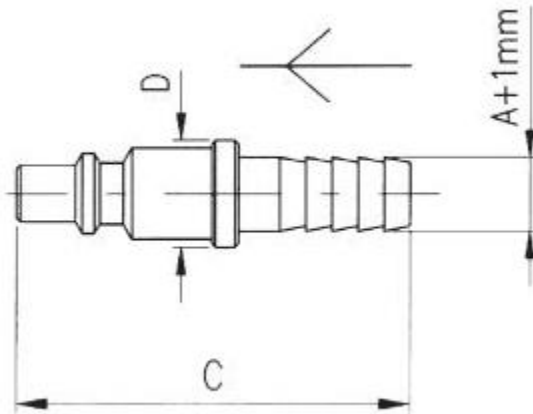

A	C	D	Pack.
8	44.5	12	10