



## Datasheet

### RS PRO Stainless steel toggle latch, 57mm length

Stock number: 1929632

EN



- Stainless steel (304) sprung toggle latch
- Complete with catchplate.

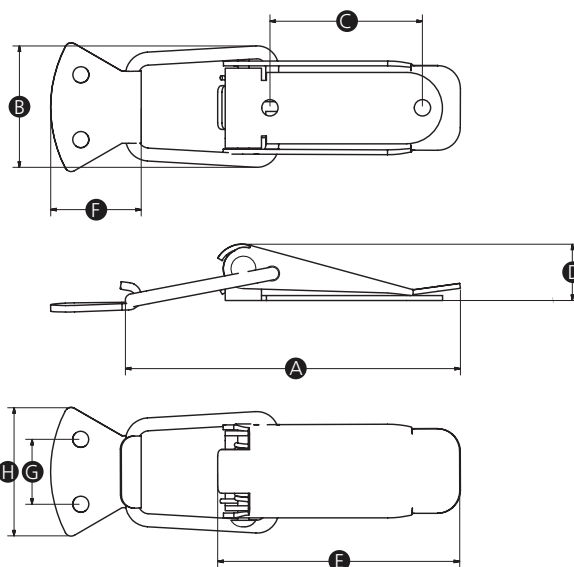

Part No.	A	B	C	D	E	F	G	H	Base hole size	Hook hole size	Max load (N)
1929632	57	23	25	9	44	20	13	25	4	4	400