

Keylock Switches





S216R



S215E-SP



Specifications:

Contact Rating	: 4A @ 125V AC, 2A @ 250V AC, 4A @ 28V DC (UL/CUL)
Max. Contact Resistance	: 10mΩ
Min. Insulation Resistance	: 500MΩ (500V DC)
Dielectric Strength	: 1,500V AC at 1 minute
Lock	: Bright Nickel Plated Zinc Alloy with Nickel Facing
Tumbler Mechanism	: 4-Disc Tumbler Cylinder
Keys	: Brass with Code Number
Contacts	: Golden Plated Cu (Q Contact Material)
Terminals	: Golden Plated Cu (Q Contact Material)

-  - Momentary position (45°)
-  - Detent positions (45° or 90°)
-  - Key pull possible in these positions







Model/Switch and Function of S215

Lock Configuration CAS Viewed from Key End	Model No. No. of Poles	Connected Terminals					Key Pull Possible Positions
		POS. 1	POS. 2	POS. 3	POS. 4	POS. 5	
	S215-A SP S215-B DP		1-2 1-2 5-6				POS. 1
	S215-C SP S215-D DP	8-1 8-1 4-5	7-8 7-8 3-4				
	S215-E SP S215-F DP		1-2 1-2 5-6	7-8 7-8 3-4			

Newark.com/multicomp-pro
 Farnell.com/multicomp-pro
 Element14.com/multicomp-pro







Keylock Switches

Lock Configuration CAS Viewed from Key End	Model No. No. of Poles	Connected Terminals					Key Pull Possible Positions
		POS. 1	POS. 2	POS. 3	POS. 4	POS. 5	
	S215-G SP	7-1	1-2	6-7			POS. 1 POS. 3
	S215-H SP	8-1	7-8	1-3			
	S215-I SP S215-J DP	8-1 8-1 4-5	1-2	7-8			POS. 1
	S215-K SP S215-L DP		1-2 5-6 7-8 3-4	7-8 3-4 1-2 5-6			

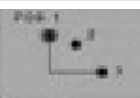

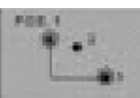

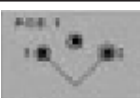



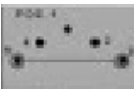
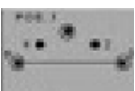

● - Detent positions (45° or 90°)

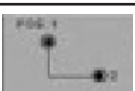
● - Key pull possible in these positions

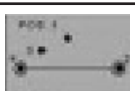
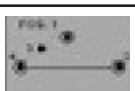
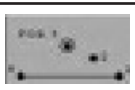
Model/Switch and Function of S216

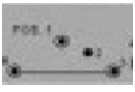
Lock Configuration CAS Viewed from Key End	Model No. No. of Poles	Connected Terminals					Key Pull Possible Positions
		POS. 1	POS. 2	POS. 3	POS. 4	POS. 5	
	A SP B DP						POS. 1
	C SP D DP			2-3 2-3 6-7			POS. 3
	E SP F DP	8-1 8-1 4-5	1-2 1-2 5-6				POS. 1 POS. 3
	G SP H SP						POS. 1
	I SP J DP			7-8 7-8 3-4			POS. 1 POS. 2 POS. 3
	K SP	8-1	1-2	2-3	7-8	6-7	POS. 1

Keylock Switches

Lock Configuration CAS Viewed from Key End	Model No. No. of Poles	Connected Terminals					Key Pull Possible Positions	
		POS. 1	POS. 2	POS. 3	POS. 4	POS. 5		
	45° indexing	L SP	8-1	1-2	2-3	7-8	6-7	POS. 3 POS. 5
		M SP						POS. 1 POS. 3 POS. 5
	90° indexing	N SP O DP	8-1 8-1 4-5	1-3 1-3 5-7	-	-	-	POS. 1
		P SP Q DP						POS. 2
		R SP S DP						POS. 1 POS. 2
	45°/90° indexing	T SP	8-1	1-3	7-8	-	-	POS. 1
		U SP						POS. 2 POS. 4
	45°/90° indexing momentary	V SP	7-1	1-3	6-7	-	-	POS. 1 POS. 2 POS. 4
	45°/90° indexing	Y SP						POS. 1
		Z SP	POS. 3 POS. 4					
		A1 SP	POS. 1 POS. 3 POS. 4					
	90° indexing	B1 SP	7-1	1-3	6-7	-	-	POS. 1
		C1 SP						POS. 2 POS. 3
		D1 SP						POS. 1 POS. 2 POS. 3

Dimensions

S216R

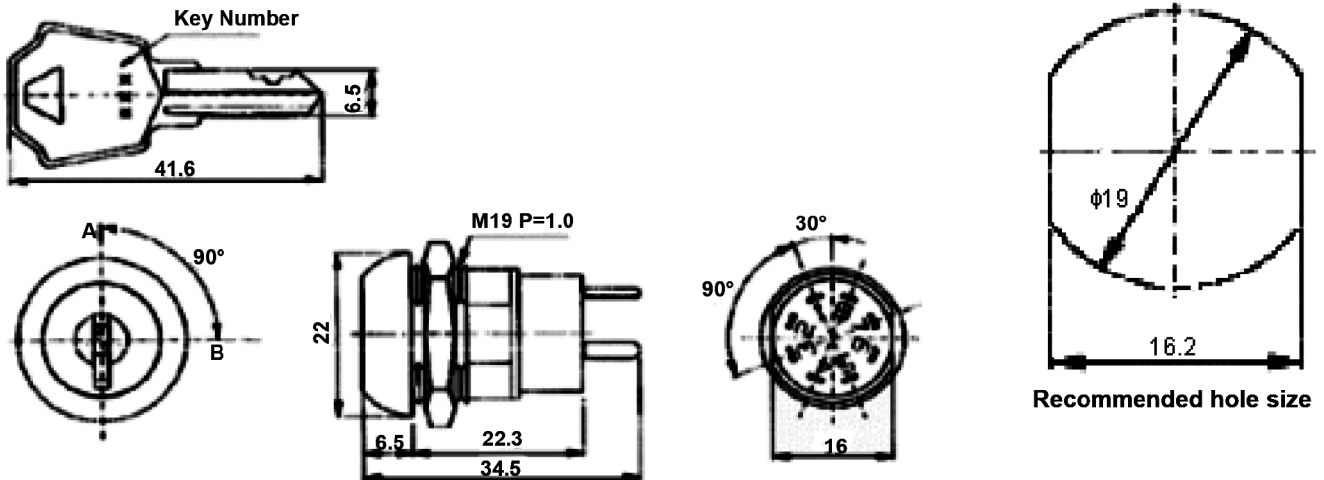

S215E-SP

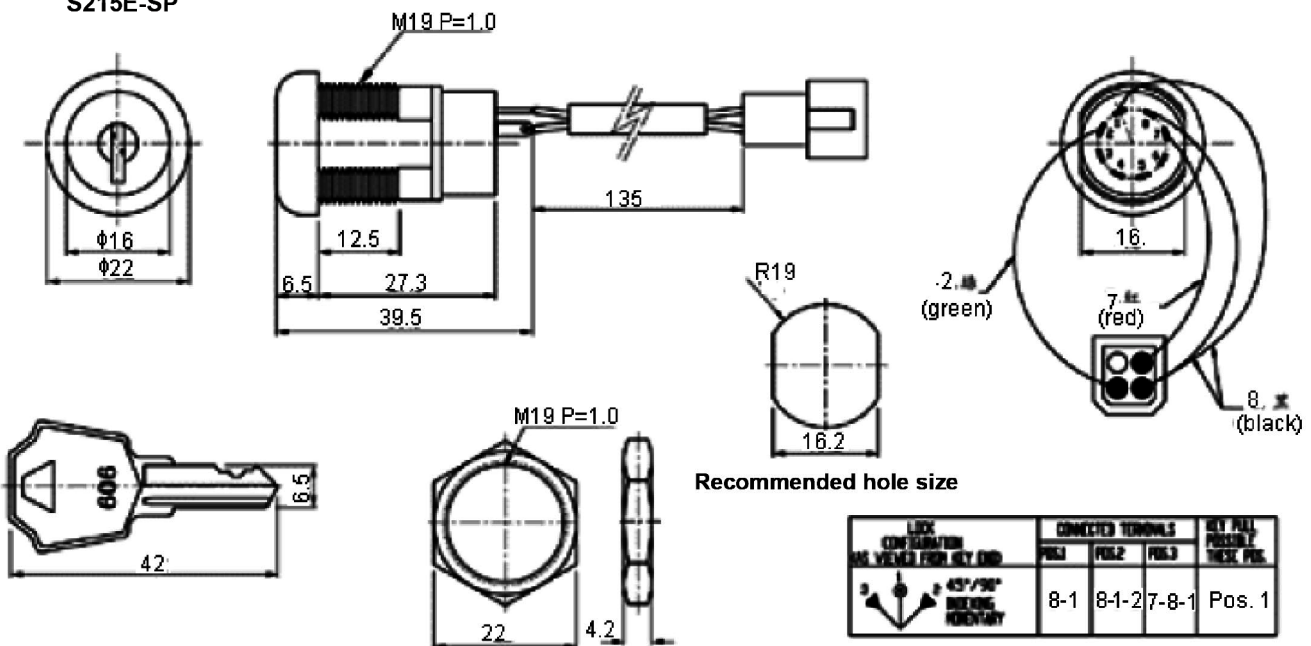

Dimensions : Millimetres

Part Number Table

Description	Part Number
Keyswitch, DPST, 2 Pos, RDM, 2 Keypull	S216R
Keyswitch, DPST, 3 Pos, MOM, RDM	S215E-SP

Important Notice : This data sheet and its contents (the "Information") belong to the members of the AVNET group of companies (the "Group") or are licensed to it. No licence is granted for the use of it other than for information purposes in connection with the products to which it relates. No licence of any intellectual property rights is granted. The Information is subject to change without notice and replaces all data sheets previously supplied. The Information supplied is believed to be accurate but the Group assumes no responsibility for its accuracy or completeness, any error in or omission from it or for any use made of it. Users of this data sheet should check for themselves the Information and the suitability of the products for their purpose and not make any assumptions based on information included or omitted. Liability for loss or damage resulting from any reliance on the Information or use of it (including liability resulting from negligence or where the Group was aware of the possibility of such loss or damage arising) is excluded. This will not operate to limit or restrict the Group's liability for death or personal injury resulting from its negligence. Multicomp Pro is the registered trademark of Premier Farnell Limited 2019.