

Datasheet

Silver Oxide Coin Button Battery

RS Stock number [593-401](#)



Description:

Non-rechargeable silver oxide coin/button cells suitable for use in cameras, clocks, watches and calculators.

Superior discharge characteristics in comparison to alkaline cells.

Good low temperature performance characteristics.

Good resistance to shock, vibration and acceleration.

Low constant internal resistance.

Excellent service maintenance.

Nominal voltage 1.55V.

Specifications:

Capacity:	42 mAh
Chemistry:	Silver Oxide
Diameter:	7.9 mm
Operating Temperature Range:	- 10 – 50 °C
Size:	SR41
Terminal Type:	Standard
Weight:	0.64 g

DIMENSIONS:

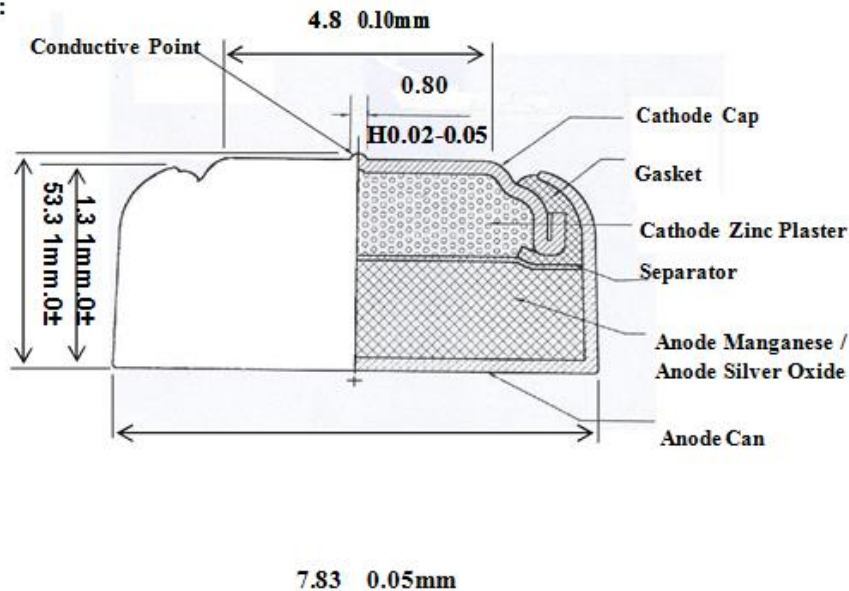

ESTIMATED AVERAGE HOURS SERVICE AT 21°C

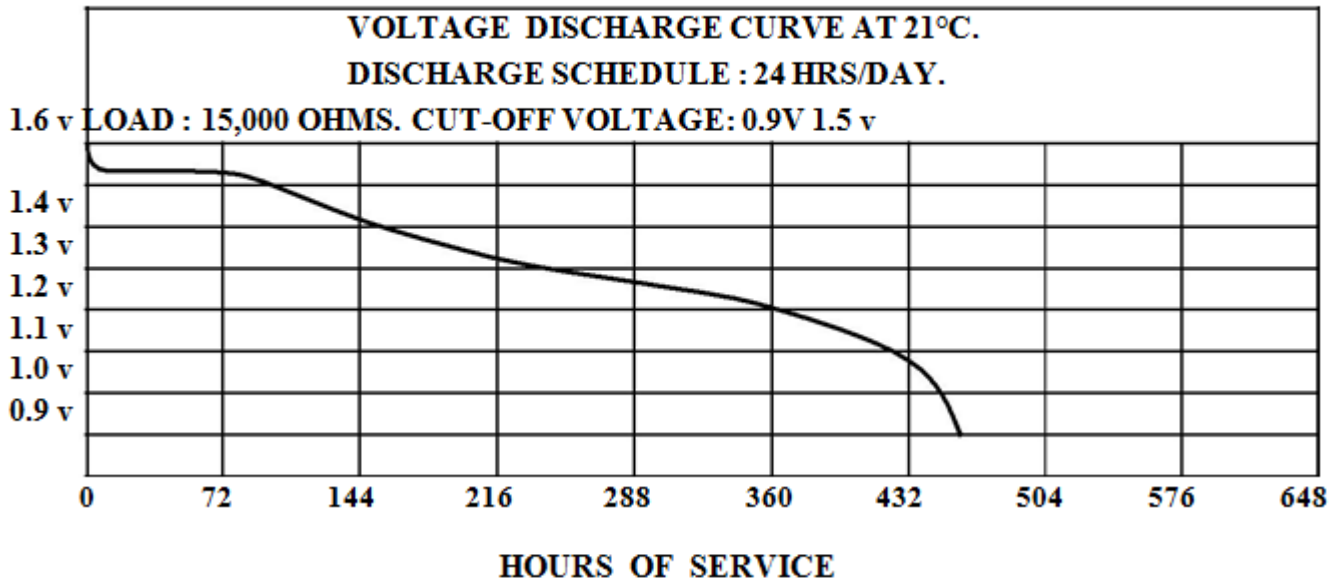

Compatibility of alternative types			
IEC ref.	Dia. (mm)	Height (mm)	Alternative part references
SR41	7.9	3.6	384, 392, SR41SW, SR736, SB-A1/D1, 280-18, V384, D384, 247, S736E
SR42	11.6	3.6	344, 350, SR1136SW, SR1136, V344, 242
SR43	11.6	4.2	301, 386, SR43SW, SR1142, SB-A8, 280-01, D, V301, 226, S1142E
SR44	11.6	5.4	SR44SW, SR1154, SB-A9, 280-08, A, V303, S1154E, D357, V357
SR45	9.5	3.6	394, SR936SW, SR936, SB-A4, 280-17, D394, 625, AG9
SR48	7.9	5.4	309, SR754W, SR754, SB-B3, F, V393, D393, 255, S754E, AG5, LR750
SR54	11.6	3.05	389, SR1130W, SR1130, SB-BU, 280-15, M, D389, 626, S1131E, AG10
SR55	11.6	2.1	381, SR1120SW, SR1121, SB-AS/DS, 280-27, V381, S1121E
SR57	9.5	2.7	395, SR926SW, SR927, SB-AP/DP, 280-48, LA, V395, D395, 610, S926E
SR58	7.9	2.1	362, SR721W, SR721, SB-BK/EK, 280-53, X, V361, S721E
SR59	7.9	2.6	396, SR726W, SR726, SB-BL, 280-52, V, D396, 612, S726E
SR60	6.8	2.15	364, SR621SW, SR621, SB-AG/DG, 280-34, T, D364, 602, S621E, AG1
SR62	5.8	1.65	317, SR516SW, V317, D317
SR63	5.8	2.15	379, SR521SW, D379
SR64	5.8	2.7	319, SR527SW, D319
SR65	6.8	1.65	321, SR616SW, SR65, V321, D321
SR66	6.8	2.6	376, SR626SW, SR66, SR626, SB-AW, 280-39, BA V377, D377, 606, S626E, AG4
SR67	7.9	1.65	315, SR716SW, D315
SR68	9.5	1.65	373, SR916SW, V373
SR69	9.5	2.1	371, SR920SW, V371, D371
—	7.9	3.1	329, SR731SW, D329