







Datasheet

RS PRO SY13 Panel Mount Connector



Technical Specifications:

Number of contact	2	3	4	5	6	7	9
Male contact face view							
Rated current (A)	13	13	5	5	5	5	3
Contact diameter (mm)	Ø1.6X2	Ø1.6X3	Ø1X4	Ø1X5	Ø1X6	Ø1X7	Ø0.7X9
Rated voltage (AC.V)	250	250	200	180	125	125	125
Test voltage(AC.V) 1 min	1500	1500	1500	1000	1000	1000	1000
Contact resistance (mΩ)	2.5	2.5	5	5	5	5	10
Wire size (mm ² / AWG)	≤2/14	≤2/14	≤0.75/18	≤0.75/18	≤0.75/18	≤0.75/18	≤0.5/20

Product Details

The RS Pro SY13 series is a range of small but robust waterproof connectors, which are sealed to IP67. Bayonet coupling ensures a quick and secure connection, even in extremely harsh environments. Versions are available for in-line cable to cable and for cable to panel connections. Plugs and receptacles are available with either male pins or female sockets. These products are especially suited for use in indoor or outdoor applications where space is at a premium.

Features and Benefits

- Bayonet Coupling
- IP67
- 2-9 Poles
- Cable to Cable and Cable to Panel Connections



Dimensional line drawings

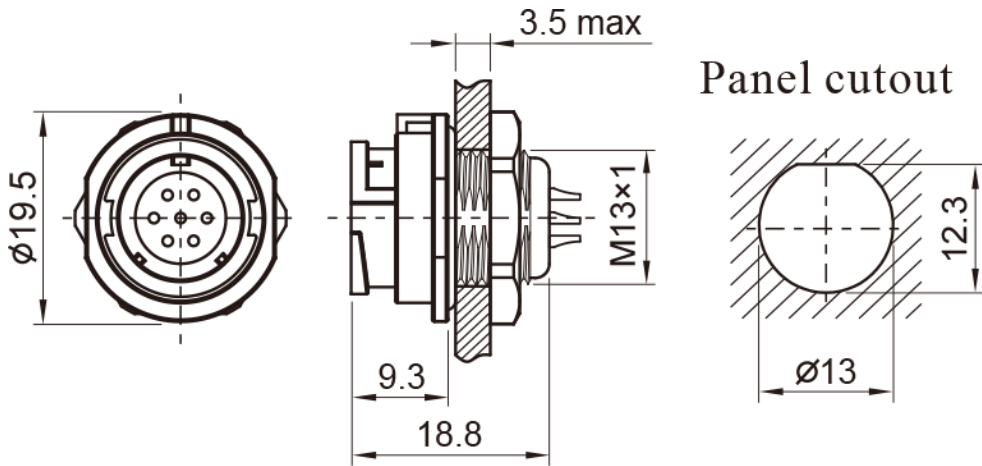

Quality Standards

