

FEATURES

- 2/2 way solenoid valve
- Pilot acting
- IP65 rated
- NBR seals

RS PRO Solenoid Valves

RS Stock No.: 2351115



Normally Open

ELP Series

Product Description

Part No.	Port Size	Voltage	Orifice
2351115	G3/8"	DC 24 V	15 mm

Features

- 2/2 way solenoid valves
- Pilot acting
- IP65 rated
- NBR seals

General Specifications / Suitability

Highest working temperature	+80°C
Lowest working temperature	-5°C
Steam	Not suitable
Oil	Very good
General chemical resistance	Normal
General acid resistance	Normal
General alkalinity resistance	Good
Water	Good

Materials

Body	Brass
Seals	NBR

Similar Products

Part No.	Port Size	Voltage	Orifice	Model Description
2351111	G1/4"	DC 24 V	3.0 mm	Direct Type NC
2351112	G3/8"	AC 220 V	15 mm	Pilot Type NC
2351113	G3/8"	DC 24 V	15 mm	Pilot Type NC
2351114	G3/8"	AC 220 V	15 mm	Pilot Type NO
2351115	G3/8"	DC 24 V	15 mm	Pilot Type NO
2351116	G1/2"	AC 220 V	15 mm	Pilot Type NC
2351117	G1/2"	DC 24 V	15 mm	Pilot Type NC
2351118	G1/2"	AC 24 V	15 mm	Pilot Type NC
2351119	G1/2"	AC 220 V	15 mm	Pilot Type NO
2351121	G1/2"	DC 24 V	15 mm	Pilot Type NO
2351122	G3/4"	AC 220 V	20 mm	Pilot Type NC
2351123	G3/4"	DC 24 V	20 mm	Pilot Type NC
2351124	G3/4"	AC 220 V	20 mm	Pilot Type NO
2351125	G3/4"	DC 24 V	20 mm	Pilot Type NO
2351126	G1"	AC 220 V	25 mm	Pilot Type NC
2351127	G1"	DC 24 V	25 mm	Pilot Type NC
2351128	G1"	AC 24 V	25 mm	Pilot Type NC
2351129	G1"	AC 220 V	25 mm	Pilot Type NO
2351130	G1"	DC 24 V	25 mm	Pilot Type NO

Specifications

Model	Direct Acting N.C.								Direct Acting N.O.							
Code	2351111															
Port Size	1/8"	1/4"	1/8"	1/4"	1/8"	1/4"	1/8"	1/4"	1/8"	1/4"	1/8"	1/4"	1/8"	1/4"	1/8"	1/4"
Orifice (mm) ❶	1.5		2		3		4		1.5		2		3		4	
Cv	0.1		0.18		0.33		0.55		0.1		0.18		0.33		0.55	
Pressure Difference (Bar)	0 - 30		0 - 20		0 - 13		0 - 8		0 - 30		0 - 16		0 - 8		0 - 5	
Acting Type	Direct Acting NC.								Direct Acting NO.							
Power consumption	Standard type: AC:15VA DC10W Low power type: AC:4VA DC3W AC110V:7.0VA								Standard type: AC:12VA DC10W Low power type: AC:4VA DC3W AC110V:7.0VA							
Guaranteed Pressure (Bar)	45															
Medium	Air, Water, Hot water, Oil (≤20CST)															
Working Temperature (°C)	-20 - 80 (No freezing)															
Voltage Range	-15 - 10%															
Insulations	F Class															
Protection grade	IP65(DIN40050)															
Valve Body Material	Brass															
Seal Material	VITON only															

❶ G, PT, NPT thread type is optional.

Model	Pilot Type N.C.				Pilot Type N.O.			
Code	2351112	2351116 2351117 2351118	2351122	2351126 2351127 2351128	2351114	2351119	2351124	2351129
Port Size ❶	3/8"	1/2"	3/4"	1"	3/8"	1/2"	3/4"	1"
Orifice (mm)	15		20	25	15		20	25
Cv	5.0	5.5	9.5	12.5	5.0	5.5	9.5	12.5
Pressure Difference (Bar)	0.5 - 16				0.5 - 13			
Acting Type	Diaphragm pilot type N.C				Diaphragm pilot type N.O			
Power consumption	Standard type: AC:15VA DC10W Low power type: AC:4VA DC3W AC110V:7.0VA				Standard type: AC:12VA DC10W Low power type: AC:4VA DC3W AC110V:7.0VA			
Guaranteed Pressure (Bar)	25				20			
Medium	Air, Water, Hot water, Oil (≤20CST)							
Working Temperature (°C)	-20 - 80 (No freezing)							
Voltage Range	-15 - 10%							
Insulations	F Class							
Protection grade	IP65(DIN40050)							
Valve Body Material	Brass							
Seal Material	NBR, EPDM, VITON							

❶ G, PT, NPT thread type is optional.

Specifications

■ Symbol:

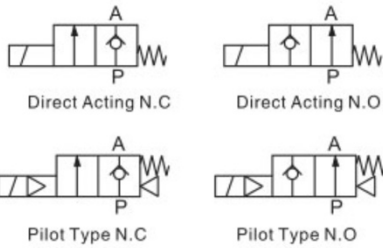

■ Mounting Dimension:

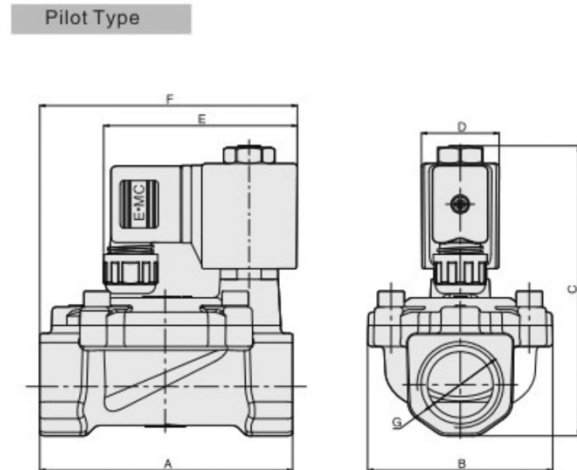
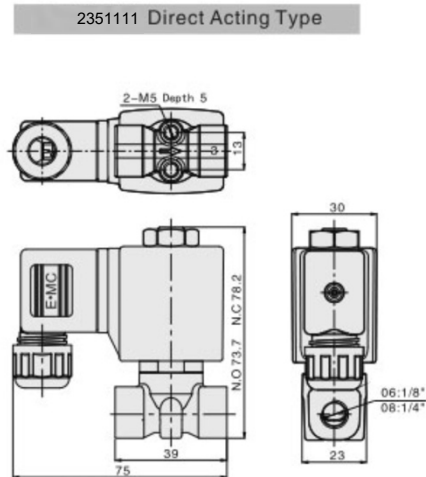

Model	A	B	C		D	E	F	G(Port)
			N.C	N.O				
2351112, 2351113 2351114, 2351115	66	47	95	99.2	30	74	74	3/8"
2351116, 2351117 2351118, 2351119, 2351121	66	47	95	99.2	30	74	74	1/2"
2351122, 2351123 2351124, 2351125	75	56	102	106.2	30	74	79	3/4"
2351126, 2351127 2351128, 2351129, 2351130	96	71	111	115.2	30	74	98	1"

Specifications

Inner Structure:

2351111 Direct Acting Type:

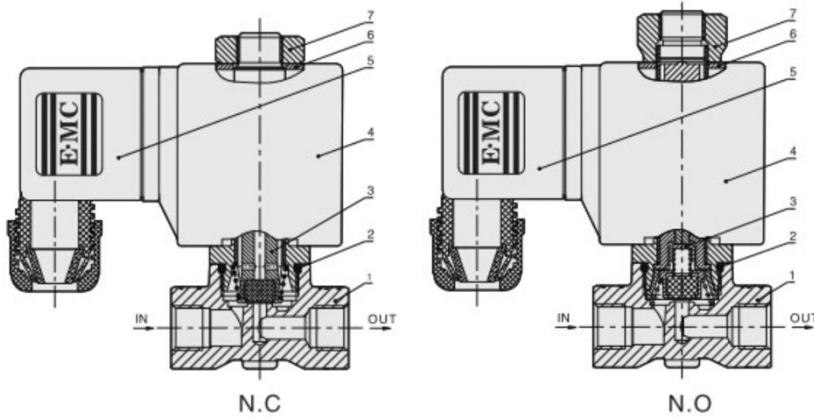

No.	Part Name
1	Valve Body
2	O-ring
3	Iron Core Components
4	Coil
5	Water Proof Connector
6	Internal Teeth Washer
7	Hexagon nut

Pilot Type

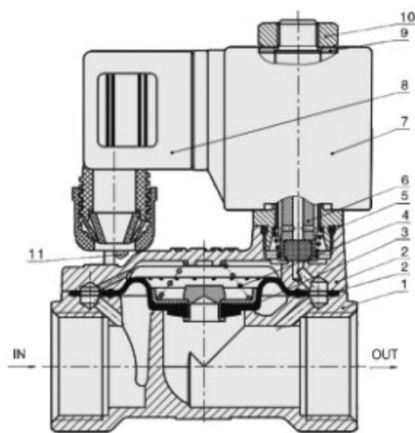

No.	Part Name
1	Valve Body
2	Spacer
3	Diaphragm Components
4	Spring
5	O-ring
6	Iron Core Components
7	Coil
8	Water Proof Connector
9	Gasket
10	Internal Teeth Washer
11	Screw

Specifications

Flow Chart:

