

Datasheet

Quick Acting F LBC Fuse, 1.6A, 5x20mm

RS Stock number [563-457](#)

UFE

UFE-A



Specifications:

Materials

Glass body/nickel plated brass caps

Lead wire: Tin-lead plated copper, Diameter $\varnothing 0.8\text{mm}$.

Interrupting Ratings

35 amperes or 10 in rated current; whichever is greater.

Operating Temperature

-55°C to + 125°C

Drawing (mm):

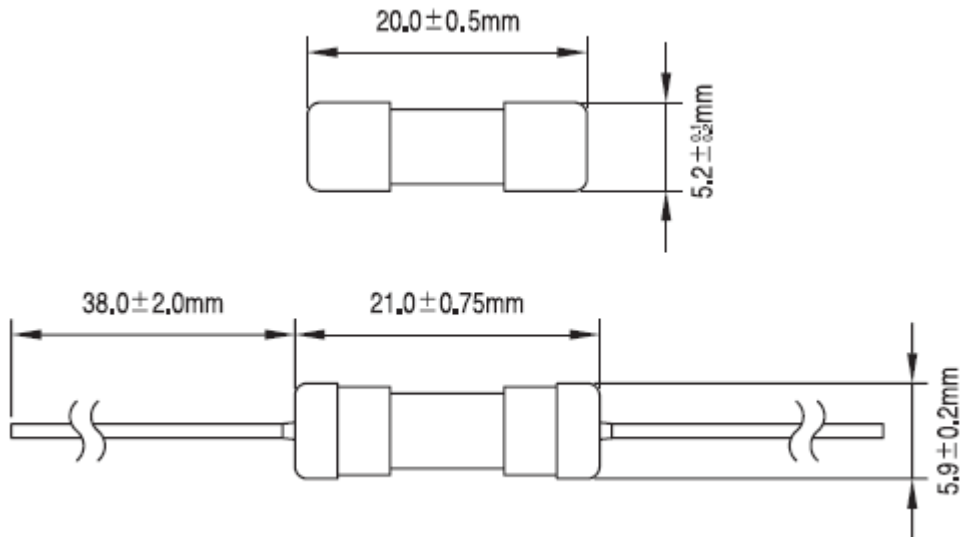

Electrical Characteristic:

Rated Current	1.5In	2.1In	2.75 In		4 In		10 In
	MIN	MAX	MIN	MAX	MIN	MAX	MAX
63mA~100mA	60 min	30 min	10 ms	500 ms	3 ms	100 ms	20 ms
125mA~6.3A	60 min	30 min	50 ms	2 sec	10 ms	300 ms	20 ms
8A~10A	30 min	30 min	50 ms	2 sec	10 ms	400 ms	40 ms