



ENGLISH

Datasheet

RS PRO 5 WAY, 2 ROW, STRAIGHT, SPRING LOADED MALE, .100" [2.54mm] PITCH, SOLDER

Stock No: 2272167, 2272168



Product Details:

RS PRO Pogo Pins and Connectors (spring loaded terminals) consist of a pin, barrel, and steel spring with or without an insulator carrier. They are used in many industries across a wide range of applications to make a secure, high reliability connection. This series is highly customizable to meet specific stroke lengths, heights, and electrical capabilities. High-temp plastics are used for our insulators and unlimited molding designs allow for many different shapes and styles to be created for specific applications.

Features & Benefits:

- High reliability, corrects connection between uneven surfaces and satisfies high vibration connection requirements.
- Increased durability for heavy duty applications Highly Customizable-
- Size, stroke, shape, pin count, etc.
- Low Cost and Easily Integrated

Material:

Insulator: PA46, rated UL 94V-0, Color: Black

Contacts: Copper Alloy

Spring: Stainless Steel

Plating:

Gold flash over Nickel underplate overall

Electrical:

Voltage rating: 12 Volts

Current rating: 1A max (3.30mm), 3A max (4.30&5.30mm)

Contact resistance @ working stroke: 20 mohms max. before test
60 mohms max. after test

Insulation resistance: 100 Mohms min

Dielectric withstanding voltage: 100 VRMS @ 60HZ

Mechanical:

Spring force: 90±20gf @ 1.0mm working stroke (3.30mm)

70±20gf @ 1.0mm working stroke (4.30 & 5.30mm)

Full stroke: 1.40mm

Life test: 10,000 Cycles Min

Temperature Rating:

Operating temperature: -30°C to +85°C

Environmental:

Lead free, RoHS compliant.

Dimensional line drawings

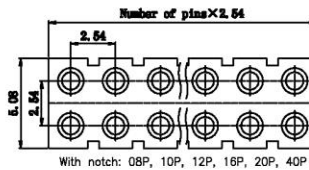
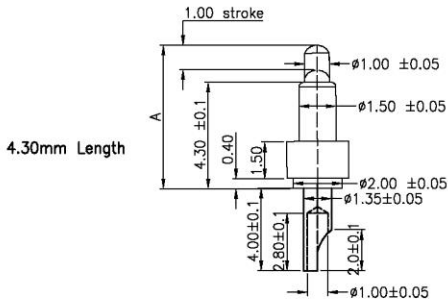

4.30mm Length
Example: PH2-3B-08-MVS-4355 = 2X4 PIN

ADAM P/N	Initial Height
PH2-3B-XX-MVS-4355	5.5mm
PH2-3B-XX-MVS-4360	6.0mm

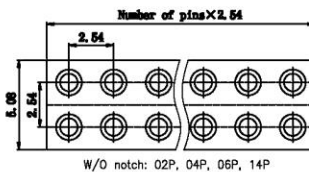
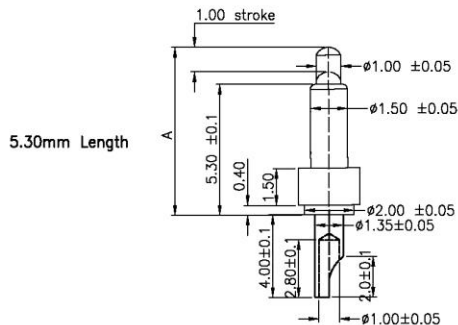

5.30mm Length
Example: PH2-3B-08-MVS-5365 = 2X4 PIN

ADAM P/N	Initial Height
PH2-3B-XX-MVS-5365	6.5mm
PH2-3B-XX-MVS-5370	7.0mm
PH2-3B-XX-MVS-5375	7.5mm
PH2-3B-XX-MVS-5380	8.0mm





rspro.com

