

Datasheet

RS Article: 177 - 0120

DC – D Frame Solenoid 12V

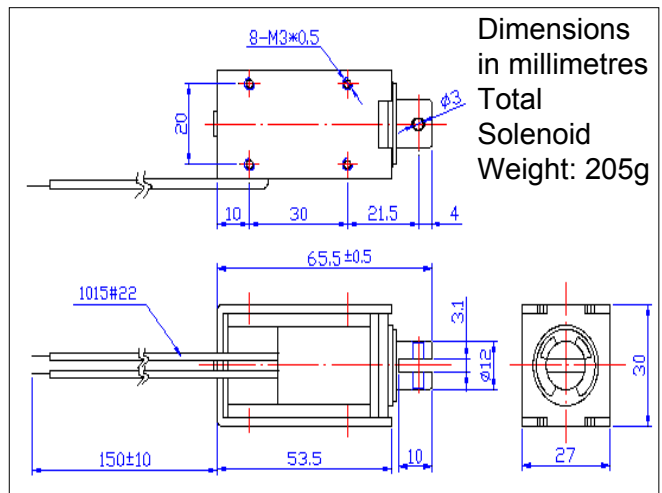
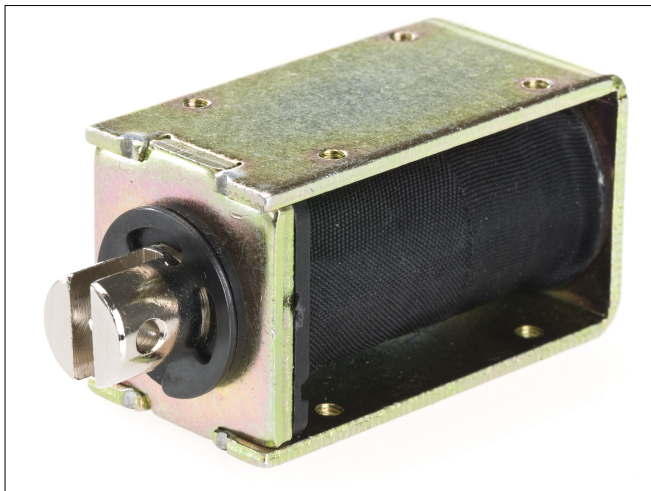

Specifications:

Features:

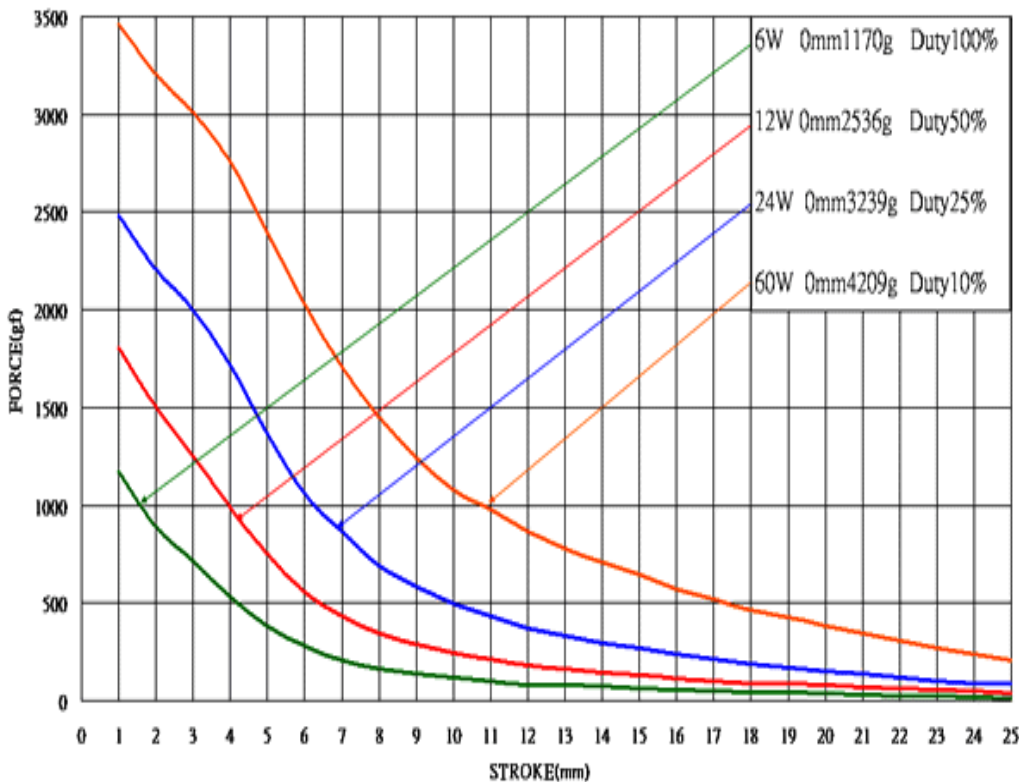

- Pull type
- Flying leads
- Corrosion resistant plated parts