



Datasheet

RS PRO Heat Sink Enclosure Model EAB

Stock number: 188-1297

EN

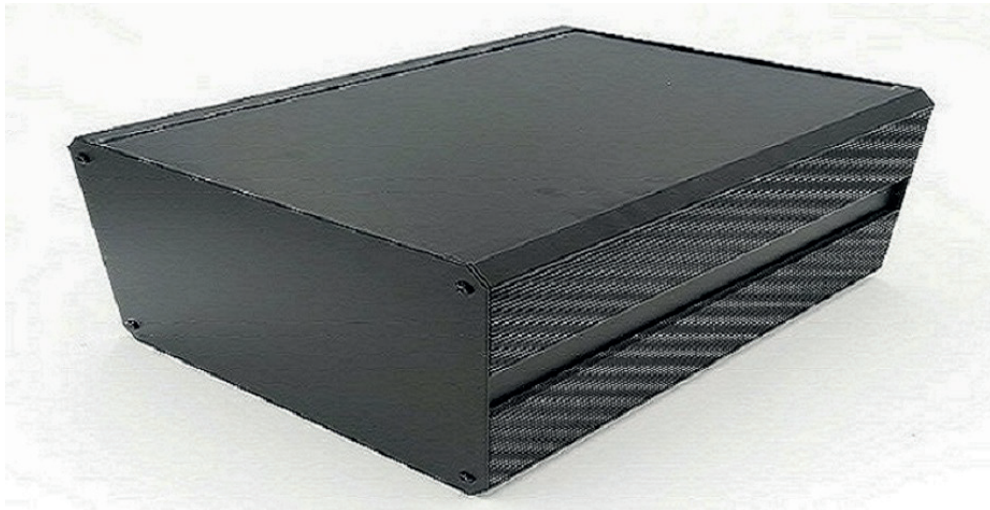

Designed for both professional users and home hobbyists alike, EAB features extruded aluminum heatsink side panel.

Features

- Extruded heavy duty aluminum (AL6063) side frames provide high efficiency cooling and strength.
- Multiple sizes for any application.
- Suitable for wide range of Electronics & Instrument applications.
- Simple and easy to assembly.
- Black powder coat standard color.

Standards and Materials

- Conforms to IEC-60297-3.
- Premium grade aluminum sheet: AL 5052 and extrusion: AA 6063 (Aluminum Alloy).
- Designed and manufactured under ISO 9001:2015 and ISO 14001:2015.
- All materials RoHS compliant.



Models and Dimensions

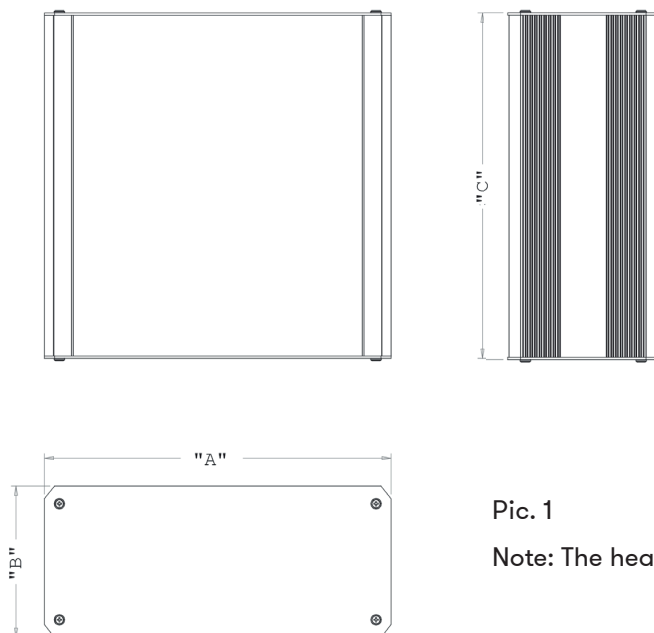

Pic. 1

Note: The head of screw M5x10 Phillips is 2.00 mm thick.

Pic. 1 Table

For side frame 3U to 6U

No.	Model	Dimension unit mm.			Net Weight (kg)	Shipping Weight (kg)
		"A"	"B"	"C"		
1	EAB 3.0-100W-200D	100	130	200	0.95	0.99
2	EAB 3.0-100W-300D	100	130	300	1.33	1.38
3	EAB 3.0-100W-400D	100	130	400	1.70	1.77
4	EAB 3.0-200W-200D	200	130	200	1.27	1.34
5	EAB 3.0-200W-300D	200	130	300	1.73	1.85
6	EAB 3.0-200W-400D	200	130	400	2.19	2.33
7	EAB 3.0-300W-200D	300	130	200	1.59	1.80
8	EAB 3.0-300W-300D	300	130	300	2.14	2.40
9	EAB 3.0-300W-400D	300	130	400	2.69	2.85
10	EAB 4.0-100W-200D	100	175	200	1.28	1.32
11	EAB 4.0-100W-300D	100	175	300	1.80	1.86
12	EAB 4.0-100W-400D	100	175	400	2.32	2.39
13	EAB 4.0-200W-200D	200	175	200	1.65	1.73
14	EAB 4.0-200W-300D	200	175	300	2.26	2.38
15	EAB 4.0-200W-400D	200	175	400	2.86	3.00
16	EAB 4.0-300W-200D	300	175	200	2.02	2.14
17	EAB 4.0-300W-300D	300	175	300	2.71	3.20
18	EAB 4.0-300W-400D	300	175	400	3.41	3.57
19	EAB 5.0-200W-200D	200	219	200	2.05	2.13
20	EAB 5.0-200W-300D	200	219	300	2.81	2.93
21	EAB 5.0-200W-400D	200	219	400	3.57	3.71
22	EAB 5.0-300W-200D	300	219	200	2.47	2.59
23	EAB 5.0-300W-300D	300	219	300	3.32	3.47
24	EAB 5.0-300W-400D	300	219	400	4.16	4.50
25	EAB 6.0-200W-200D	200	264	200	2.46	2.53
26	EAB 6.0-200W-300D	200	264	300	3.37	3.49
27	EAB 6.0-200W-400D	200	264	400	4.28	4.42
28	EAB 6.0-300W-200D	300	264	200	2.93	3.05
29	EAB 6.0-300W-300D	300	264	300	3.93	4.08
30	EAB 6.0-300W-400D	300	264	400	4.92	5.08

Description:

	Quantity
1. Side Frame	[2]
2. Top/Bottom Cover	[2]
3. Front/Rear Panel	[2]
4. Umbrella Phillips Screw M5-10 (Dog Point)	[8]
5. Rubber Feet	[4]

General Purpose Bar Kit [GP Bar] option

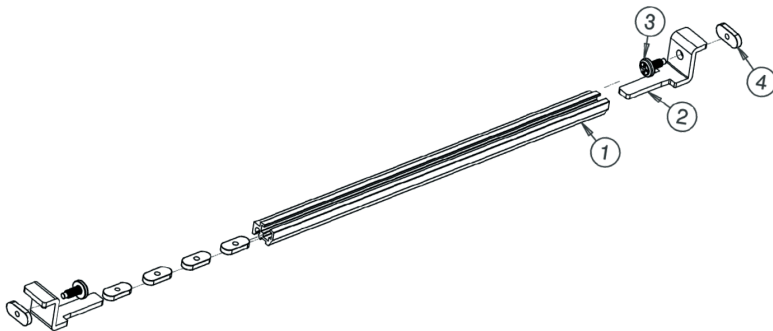

GP Bar Profile



GP Bar Large side: GP Bar L
for EAB3.0, EAB4.0, EAB5.0 and
EAB6.0



GP Bar Small side: GP Bar S
for EAB1.0 and EAB2.0

GP Bar Kit (L or S) consist of

	Quantity
1. GP Bar (L or S)	[2]
2. GP Bracket	[4]
3. Umbrella Phillips Screw M3-6 (Dog Point)	[4]
4. Nut OB M3	[12]

Note: GP Bar length relates to width ["A" dimension] when you order please tell us GP Bar profile and the width such as "GP-S Bar 100W or GP-L Bar 200W".

User should prepare all component assemblies and complete any modifications (drilling/punching holes) before assembly.

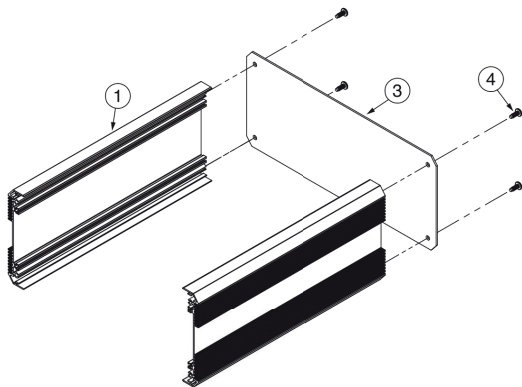

1. Install ③ front/rear panel to ① side frame and secure with ④ Umbrella Phillips Screw M5-10 (Dog Point).

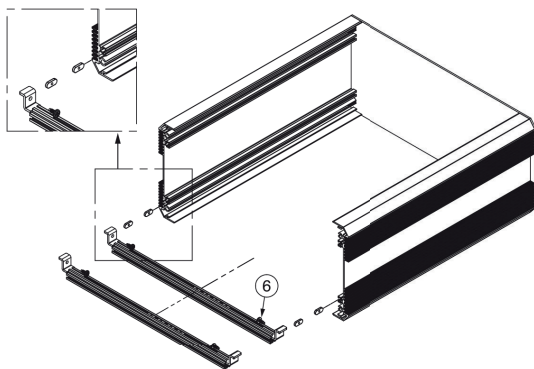

2. Install ⑥ GP Bar Kit [option] into the slide rail slot in side frame and secure with GP Bar position by Umbrella Phillips Screw M5-10 (Dog Point). We advise to install user components at this stage. Our GP Bar Kits are ideal for this purpose, but user can prepare their own method.

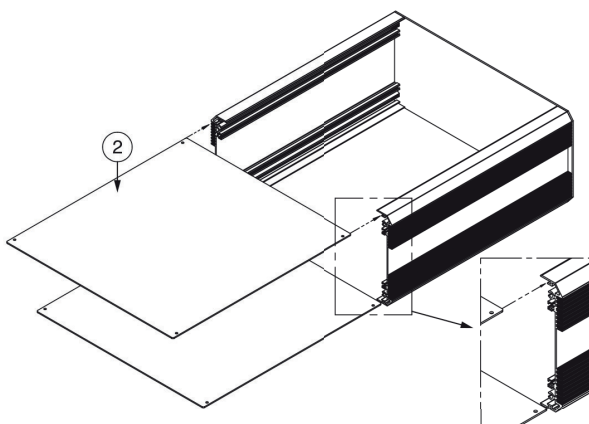

3. Slide the ② top/bottom covers into the side frame slots.

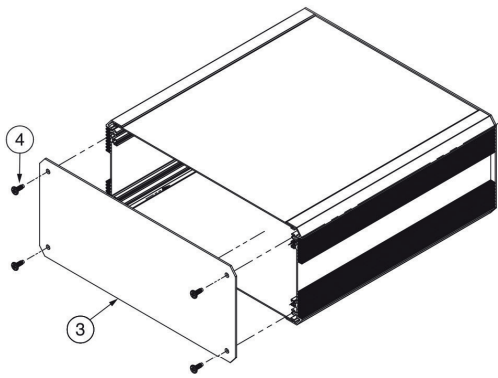

4. Install ③ front/rear cover and secure with Umbrella Phillips Screw M5-10 (Dog Point).

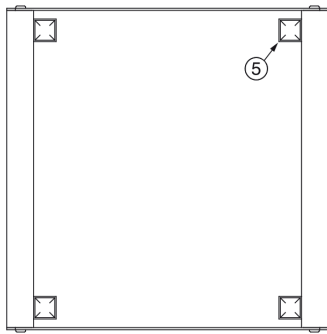

5. Place the ⑤ rubber feet 4 pcs. At the bottom side of EAB box.
*clean surface before placing rubber foot. Isopropyl Alcohol 70% is recommended

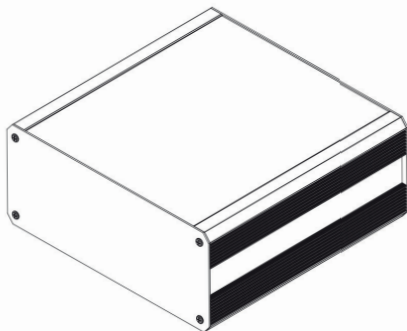

6. Completed Assembly

Specifications

Attribute	Value
Product 188-1297	EAB 6.0-200W-400D
External Width	200mm
External Depth	400mm
External Height	264mm
External Dimensions	200 x 400 x 264
Body Material	Aluminum Extrusion
IP Rating	IP40
Color	Black
Lid Color	Black
Flanged	No
Shielded	No
Gasket Material	No
Standard Met	ROHs Compliant
Application	Electrical, Electronic, Industrial