

# Crocodile Clip



## FEATURES

- Heavy Duty Clip
- Crimp or Screw Connection

## RS PRO Electric Crocodile Clip

RS Stock No.: 2081135, 2081133, 2081134, 2081136



RS Professionally Approved Products bring to you professional quality parts across all product categories. Our product range has been tested by engineers and provides a comparable quality to the leading brands without paying a premium price.

Product Description

# Crocodile Clip



- *Crocodile Clips for 5A, 10A, 25A and 50A*
- *heavy duty alligator clips with screw and crimp terminations, are ideal for testing and battery connection purposes and other applications that require a heavy duty alligator clip.*

## General Specifications

<b>Material</b>	Steel
<b>Contact Material</b>	Nickel Plated
<b>Rating</b>	25A
<b>Insulated</b>	No

## Product range

Stock No.	Brand	Product Name	Rating	Jaw opening
2081135	RS PRO	Electric crocodile clip	25A	22.5mm
2081136	RS PRO	Electric crocodile clip	50A	32.0mm
2081134	RS PRO	Electric crocodile clip	5A	9.0mm
2081133	RS PRO	Electric crocodile clip	10A	12.5mm

Drawing:

2081135

# Crocodile Clip

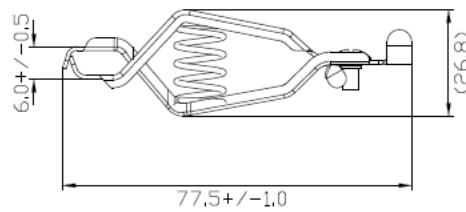

MATERIALS:  
STEEL, NICKEL PLATED  
UNIT:MM

2081136

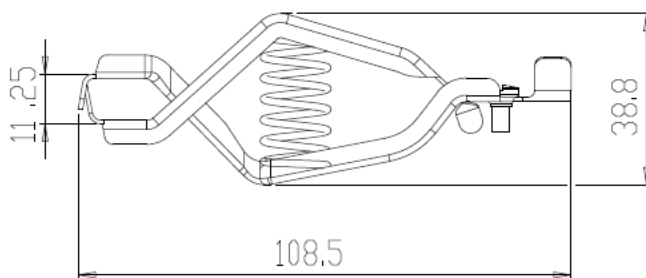
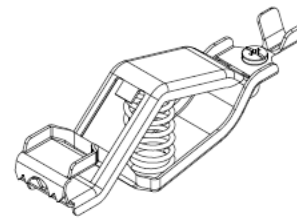
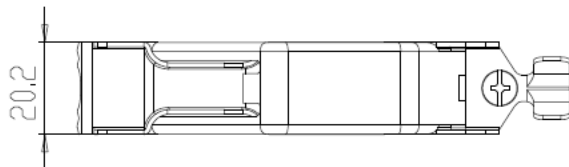

MATERIALS:  
STEEL, NICKEL PLATED  
UNIT:MM

# Crocodile Clip



2081134

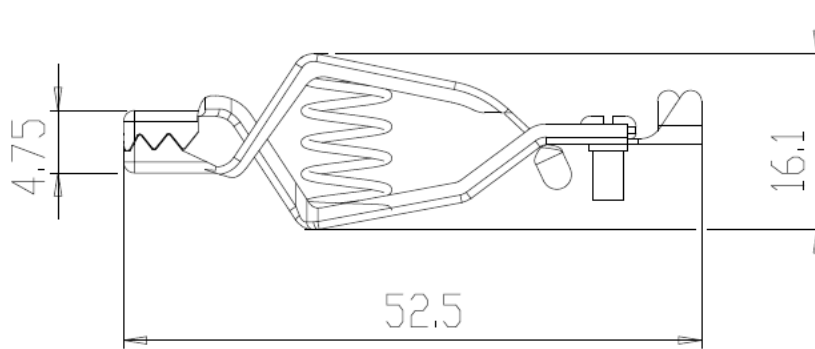
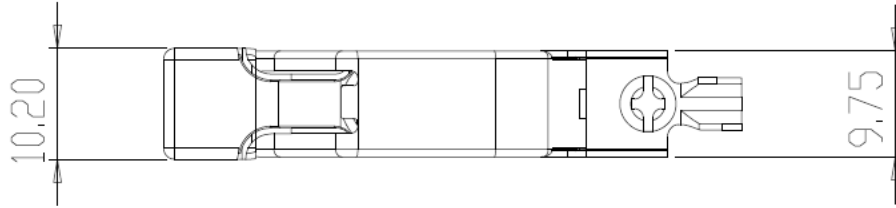

UNIT:MM

2081133

# Crocodile Clip

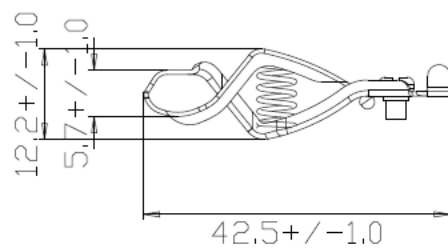
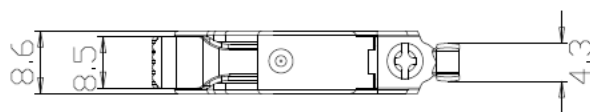

MATERIALS:  
STEEL, NICKEL PLATED  
UNIT:MM

---

Connection Diagrams / Assembly Diagrams / Illustrations / Accessories