

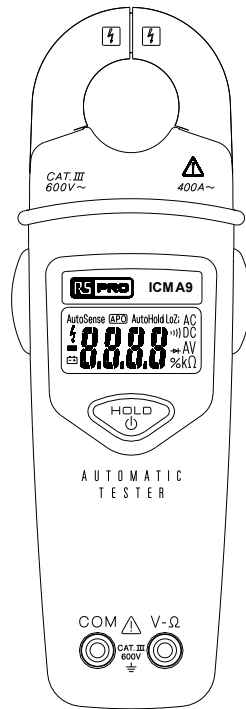

Instruction Manual
ICM A9
Electrical Clamp Multimeter

EN FR IT DE ES

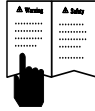



⚠ Read First

⚠ Safety Information

To ensure safe operation and service of this Clamp-multimeter, read these instructions completely before use and comply with them fully when using it.

Failure to observe these warnings can result in severe **injury** or **death**.

- Avoid working alone so assistance can be rendered.
- Do not use test leads or the Tester if they look damaged.
- Do not use the Tester if the Tester is not operating properly or if it is wet.
- Use the Tester only as specified in the Instruction card or the protection by the Tester might be impaired.
- Use extreme caution when working around bare conductors or bus bar. Contact with the conductor could result in electric shock.
- Do not use the Tester to measure voltages in circuits that could be damaged by the Tester's low input impedance (approximate $4K\Omega$)
- Use caution with voltages above 30 V ac rms, or 60 V dc. These voltages pose a shock hazard.

Symbols as marked on the Clamp-multimeter and Instructions

	Risk of electric shock
	See instruction manual
	DC measurement
	Equipment protected by double or reinforced insulation
	Battery
	Earth
	AC measurement
	Conforms to EU directives
	Application around and removal from hazardous live conductors is permitted
	Dispose of in accordance with local regulations

Power On / Off

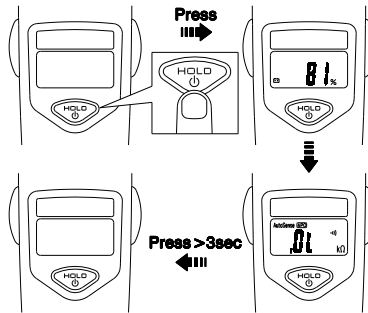

- The tester displays Battery Capacity when powering up. Please replace the battery when 0% is shown.

⚠ Caution

The Tester powers up in Ω / continuity mode.

Auto Power Off

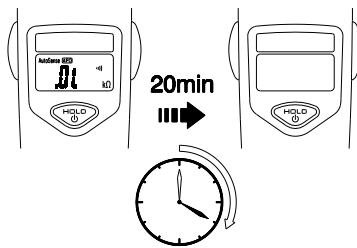

Auto Power Off Enable / Disable

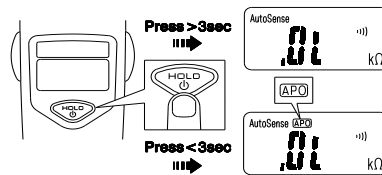

Auto Hold Enable / Disable

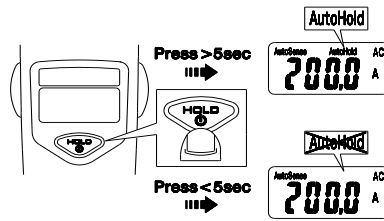

Self-Testing Aid

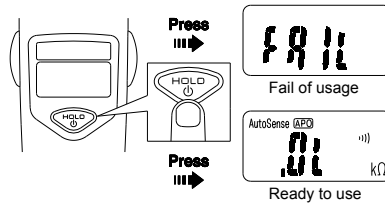

- Do not measure while the tester powering up, it will cause Self-Testing failure.

⚠ Caution

Do not use the tester when "FAIL" is shown. Undiscovered failure could exist even "FAIL" is not shown.

Continuity

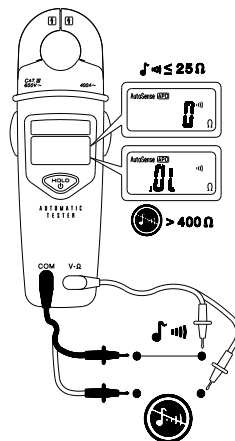

AC V / DC V

⚠ Caution

When connecting the test leads to the circuit or device, connect the black lead before the red lead ; when removing the test leads, remove the red lead before the black lead.

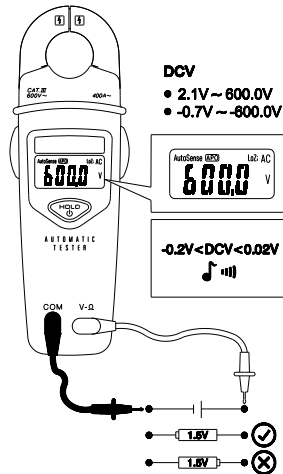
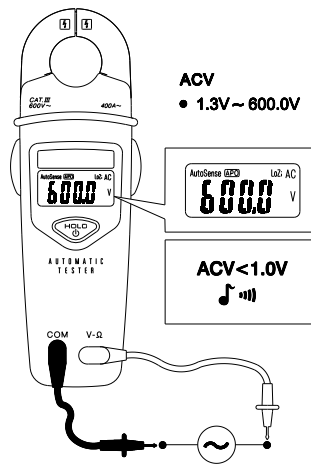

Note : to measure batteries with voltage less than 2.1 Vdc the tester must be connected in reverse polarity see illustration above.

• **Input Impedance**

$\geq 4K$ for input voltage up to 30V.

Impedance increases with input voltage to approximate 375K Ω at 600V.

⚠ Warning

Do not apply more than 1000VDC / 600 VAC between Tester terminal and earth ground.

⚠ Caution

If the tester is used in the vicinity of equipment which generates electromagnetic interference, the display may become unstable or the measurements show may be subject to large errors.

Resistance / Diode

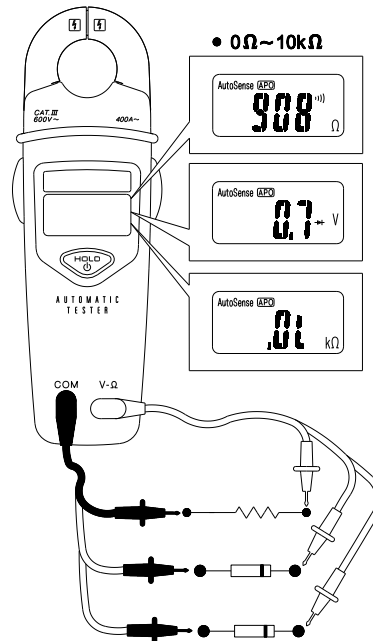

AC A

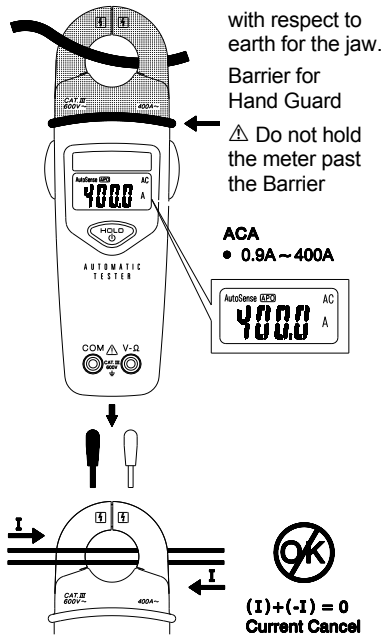

Data Hold

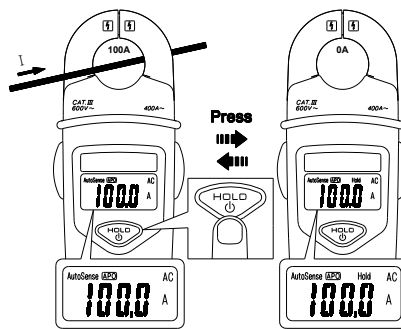

Data Hold is not available when "OL KΩ" is displayed with no input signals.

Data Hold Beep Guard

In Data Hold mode, the LCD will flash and the internal speaker will sound continuously in the following two situations:

1. The tester measures a different signal to that shown on the LCD.
2. The measured signal is the same units as the LCD reading, but different by more than 50 counts to the LCD reading.

Auto Hold (ACA only)

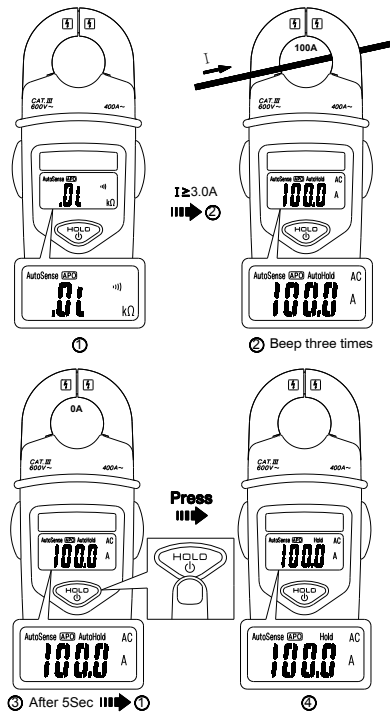

Priority of function

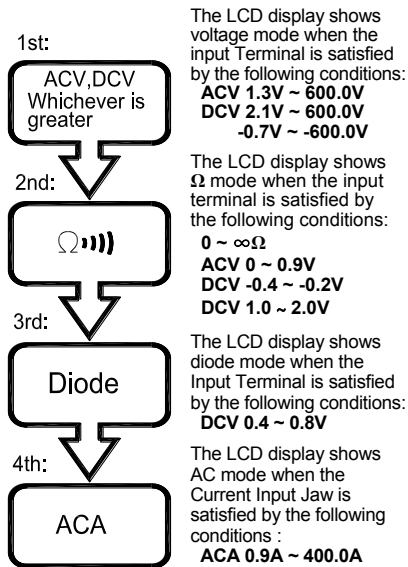

Battery Replacement

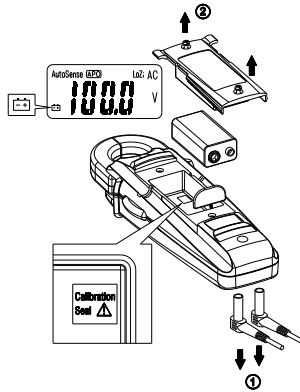

⚠Caution :
 The calibration seal can only be punctured by certified distributor for annual calibration otherwise the meter's performance can not be warranted.

Maintenance

Do not attempt to repair this tester.
It contains no user-serviceable parts.
Repair or servicing should only be performed
by qualified personnel.

Cleaning

Periodically wipe the case with a dry cloth
and detergent do not use abrasives or
solvents.

TEST EQUIPMENT RISK ASSESSMENT

Users of this equipment and or their employers are reminded that Health and Safety Legislation require them to carry out valid risk assessments of all electrical work so as to identify potential sources of electrical danger and risk of electrical injury such as from inadvertent short circuits. Where the assessments show that the risk is significant then the use of fused test leads constructed in accordance with HSE guidance note GS38 "Electrical Test Equipment for use by Electricians" should be used.

Specifications

1-1 General Specifications

LCD display digits :

6000 digit large scale LCD readout.

Measuring rate :

3 times / sec of ACV/DCV diode.

3 times / sec of resistance.

2 times / sec of ACA.

Overrange display :

"OL" is displayed for " Ω " function,
shows the real value for "A" and "V"
function.

Automatic power off time :

Approximately 20 minutes after power on
without operations.

Low battery indicator :

Replace the battery when the indicator "+"
appears in the display.

Power requirement : 9V battery.

Battery type and life :

ALKALINE PP3, 9V 250 hours.

1-2 Environmental Conditions

Indoor Use.

Calibration :

One year calibration cycle.

Operating temperature :

0°C ~ 30°C (≤80% RH)

30°C ~ 40°C (≤75% RH)

40°C ~ 50°C (≤45%RH)

Storage temperature :

-20 to +60°C, 0 to 80% RH (batteries not fitted).

Operating altitude : 2000m (6562 ft)

Overvoltage category :

IEC 61010-1 600V CAT. III.

CAT Application field

I	The circuits not connected to mains.
II	The circuits directly connected to Low-voltage installation.
III	The building installation.
IV	The source of the Low-voltage installation.

Conductor Size : 27mm diameter.

Pollution degree : 2

EMC : EN 61326-1

Shock vibration :

Sinusoidal vibration per MIL-T-28800E (5 ~ 55 Hz, 3g maximum).

1-3 Electrical Specifications

Accuracy is \pm (% reading + number of digits)
at 23°C \pm 5°C < 80%RH.

Temperature coefficient :

0.2 x (Specified accuracy) / °C, < 18°C, >
28°C .

Voltage

Function	Range	Accuracy
V \sim	1.3V ~ 600.0V	\pm (1.5% + 3 dgt) 50Hz ~ 500Hz
V \equiv	2.1V ~ 600.0V -0.7V ~ -600.0V	\pm (1% + 2 dgt) \pm (1% + 4 dgt)

Overload protection : 600 Vrms

Max Operation time :

DT=30s for \geq 30V

Input impedance : \geq 4k Ω for input voltage
up to 30V. Impedance increases with input
voltage to approximate 375k Ω at 600V.

Resistance & Continuity

Function	Range	Accuracy
Ω \rightarrow	0.0 Ω ~ 9999 Ω	\pm (2% + 2 dgt)
\rightarrow	0.4V ~ 0.8V	\pm (1% + 3 dgt)

Overload protection : 600V rms

Max. open circuit voltage : 1.5V

Continuity check : Internal sound activates
if the resistance of the circuit under test is
less than 25 Ω .

It will then turn off if the resistance is
increased beyond 400 Ω .

AC Current

Function	Range	Accuracy
A%	0.9A ~ 400.0A	\pm (1.8% + 3 dgt) 50Hz ~ 60Hz

Overload protection : 400A

Africa

RS Components SA

P.O. Box 12182,
Vorna Valley, 1686
20 Indianapolis Street,
Kyalami Business Park,
Kyalami, Midrand
South Africa

www.rs-components.com

Asia

RS Components Pte Ltd.

31 Tech Park Crescent
Singapore 638040

www.rs-components.com

China

RS Components Ltd.

Suite 23 A-C
East Sea Business Centre
Phase 2
No. 618 Yan'an Eastern Road
Shanghai, 200001
China

www.rs-components.com

Europe

RS Components Ltd.

PO Box 99, Corby,
Northants. NN17 9RS
United Kingdom

www.rs-components.com

Japan

RS Components Ltd.

West Tower (12th Floor),
Yokohama Business Park,
134 Godocho, Hodogaya,
Yokohama, Kanagawa 240-0005
Japan

www.rs-components.com

U.S.A

Allied Electronics

7151 Jack Newell Blvd. S.
Fort Worth, Texas 76118
U.S.A.

www.alliedelec.com

South America

RS Componentes Limitada

Av. Pdte. Eduardo Frei M. 6001-71
Centro Empresas El Cortijo
Conchalí, Santiago, Chile

www.rs-components.com