



ENGLISH

Datasheet

Right Angle 2 Hole Bracket Hot Dipped Galvanised

RS Stock No **1766905**

Size **48 x 50mm**

Used to connect Channel/Strut together at a 90° angle

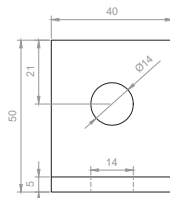

FRONT VIEW

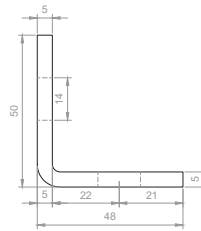

SIDE VIEW

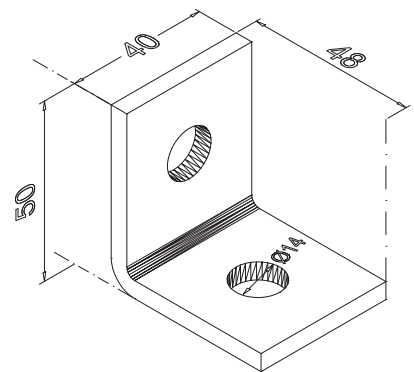

Please view our full range listing below

RS Stock No	Size (mm)
1766905	48 x 50 (2 hole bracket)
1766904	50 x 96 (3 hole bracket)
1766902	57 x 90 (3 hole bracket)
1766901	41 x 102 (3 hole bracket)
1766900	55 x 132 (4 hole bracket 1 x 3)
1766899	86 x 102 (4 hole bracket 2 x 2)