

Datasheet

Worm Drive Thumb Screw with PVC Hose Clip

RS Stock No: 145-0291



Specification:

Material: Mild Steel

Plating: Zinc Plated

RoHS Complaint

Drawing:

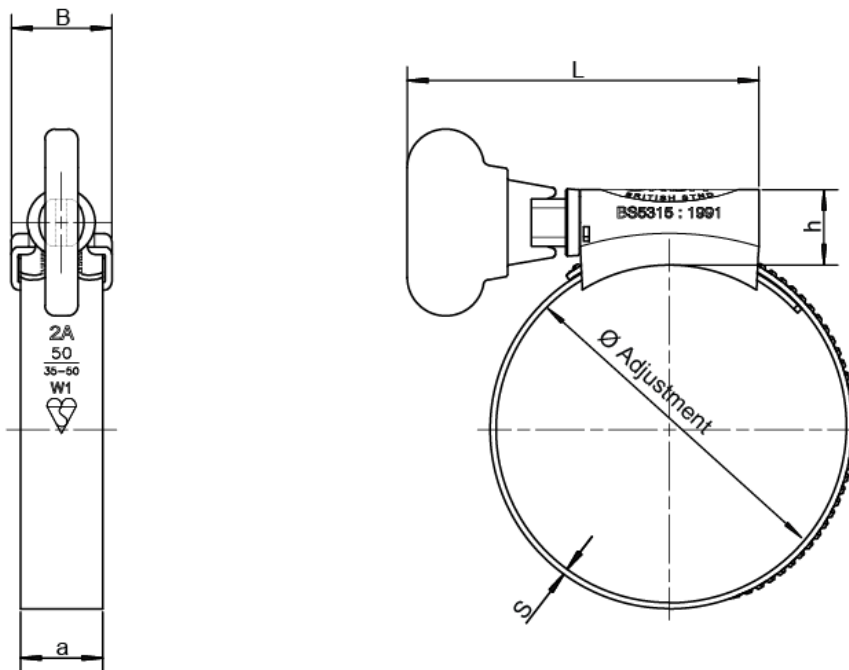

Stock no	BS Size	Range		L max	S±0.05	h max	a Band Width	b max	Torque Nm
		mm	in						
1450287	12	9.5 – 12	3/8 - 1/2	19.5	0.95	10.0	9.5	12.3	4.5
1450288	16	11 – 16	1/2 - 5/8						
1450289	20	13 – 20	1/2 - 3/4						
1450290	22	16 – 22	5/8 - 7/8	25.0		11.5	12.0	14.7	5.6
1450291	25	18 – 25	3/4 - 1						
1450292	30	22 – 30	7/8 - 1 1/8						
1450293	35	25 – 35	1 - 1 3/8						
1450294	40	30 – 40	1 1/8 - 1 5/8						
1450295	50	35 – 50	1 3/8 - 2	33.0				7.9	



Product feature:

These hose clips are made from the finest cold rolled steel with a special surface treatment. They are manufactured and “BSI Kitemark™” certified according to British Standard 5315:1991.

The band is processed to erase any burrs from the edges and to increase strength ensuring a high destructive torque. The band thread is cold formed and results in smooth underside surface to optimize hose protection. It protects soft hoses from damage during installation, providing exterior hose wall protection. The housing is riveted for extra strength and provides smooth contact with the hose.