

Tactile Switches

6mm × 6mm, Surface Mount / Through Hole

multicomp PRO

**RoHS
Compliant**

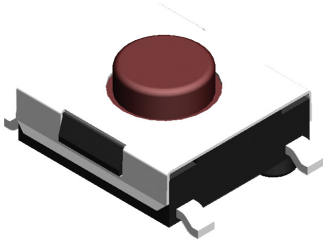

Features

- Sealed
- Reflow solderable
- Dust proof with high reliability.

Application

- Audio, OA Equipment
- Instrumentation, Communication
- White goods

Specification

Contact Rating	: 50mA, 12V DC
Contact Resistance	: 100mΩ max.
Insulation Resistance	: 100MΩ min. 500V DC
Dielectric Strength.	: 250V AC / 1 minute
Operating Force	: 160 ±50gf, Brown(N) 66/677 260 ±70gf, Red(R) 69/67/65/64 360 ±90gf, Transparent(T) 69/67/65/677
Travel	: 0.25mm 68S/66N/66R/677 0.45mm (69/67N,R) (65/64N,R,T) 0.6mm 69/67T
Operating Life	: 100,000 cycles min. for 68/66/677 500,000 cycles min. for 69/67/65/64
Operating Temp.	: -25°C to +70°C
Storage Temp.	: -30°C to +80°C

Circuit

Without Ground Pin

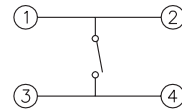

With Ground Pin

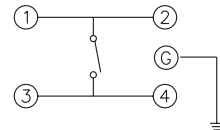

Diagram

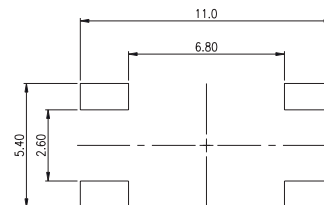
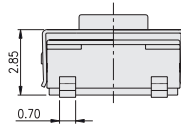
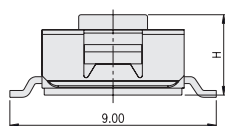
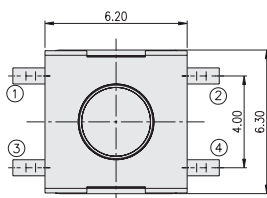

P.C.B. LAYOUT

Dimensions : Millimetres

Newark.com/multicomp-pro
Farnell.com/multicomp-pro
sg.element14.com/b/multicomp-pro

multicomp PRO

Tactile Switches

6mm × 6mm, Surface Mount / Through Hole

multicomp PRO

Through Hole

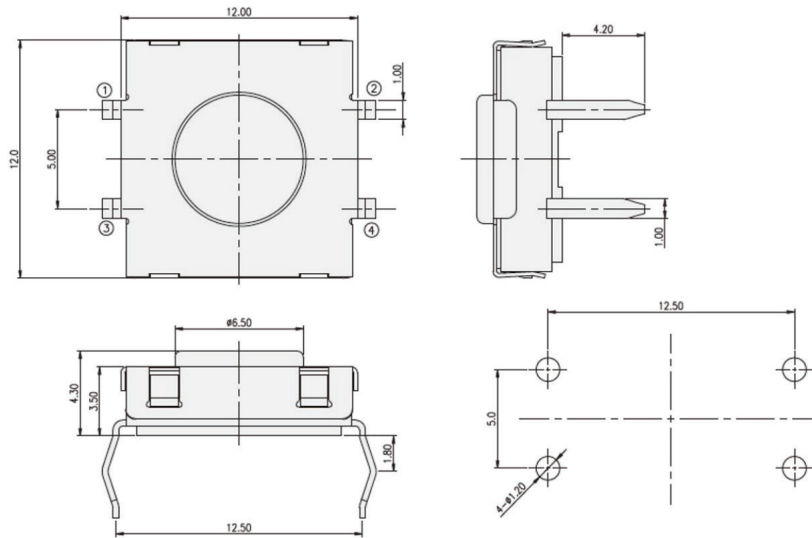

Part Number Table

Description	Part Number
Tactile Switch with Washable Type, Surface Mount, 5.2mm, Red, 260gf	MPTSMW-67R-V
Tactile Switch with Washable Type, Surface Mount, 5.2mm, Clarity, 360gf	MPTSMW-67T-V
Tactile Switch with Washable Type, Surface Mount, 3.8mm, Brown, 160gf	MPTSMW-69N-V
Tactile Switch with Washable Type, Surface Mount, 3.8mm, Red, 260gf	MPTSMW-69R-V
Tactile Switch with Washable Type, Surface Mount, 3.8mm, Clarity, 260gf	MPTSMW-69T-V
Tactile Switch with Washable Type, Through Hole, 4.5mm, Brown, 180gf	MPTSHW-64N-V
Tactile Switch with Washable Type, Through Hole, 4.5mm, Red, 260gf	MPTSHW-64R-V
Tactile Switch with Washable Type, Through Hole, 3.5mm, Brown, 180gf	MPTSHW-65N-V
Tactile Switch with Washable Type, Through Hole, 3.5mm, Red, 260gf	MPTSHW-65R-V
Tactile Switch with Washable Type, Through Hole, 3.5mm, Clarity, 360gf	MPTSHW-65T-V
Tactile Switch with Washable Type, Through Hole, 5.2mm, Brown, 180gf	MPTSHW-67N-V
Tactile Switch with Washable Type, Through Hole, 5.2mm, Red, 260gf	MPTSHW-67R-V
Tactile Switch with Washable Type, Through Hole, 5.2mm, Clarity, 360gf	MPTSHW-67T-V
Tactile Switch with Washable Type, Through Hole, 3.8mm, Red, 260gf	MPTSHW-69R-V
Tactile Switch with Washable Type, Through Hole, 3.8mm, Clarity, 360gf	MPTSHW-69T-V

Important Notice : This data sheet and its contents (the "Information") belong to the members of the AVNET group of companies (the "Group") or are licensed to it. No licence is granted for the use of it other than for information purposes in connection with the products to which it relates. No licence of any intellectual property rights is granted. The Information is subject to change without notice and replaces all data sheets previously supplied. The Information supplied is believed to be accurate but the Group assumes no responsibility for its accuracy or completeness, any error in or omission from it or for any use made of it. Users of this data sheet should check for themselves the Information and the suitability of the products for their purpose and not make any assumptions based on information included or omitted. Liability for loss or damage resulting from any reliance on the Information or use of it (including liability resulting from negligence or where the Group was aware of the possibility of such loss or damage arising) is excluded. This will not operate to limit or restrict the Group's liability for death or personal injury resulting from its negligence. Multicomp Pro is the registered trademark of Premier Farnell Limited 2019.

Newark.com/multicomp-pro
 Farnell.com/multicomp-pro
 sg.element14.com/b/multicomp-pro

multicomp PRO