



Datasheet

RS PRO Sub-Miniature Pushbutton Switches

Stock number: **175-8605, 175-8604**

EN



The picture above is for reference only.
Please refer to the table in the drawing below for other colors.

Package Contain:

- 1x Nut
- 1x Locking Washer
- 1x Splash Proof O-Ring

Specifications:

- Switch type: Pushbutton
- Poles/throws: SPST
- Switch functions: on-mom

Max. Current/voltage rating with resistive load:

400ma 32vac - 200 ma 50vdc - 125 ma 125vac.

Initial contact resistance: 50mΩmax.

Insulation resistance: 1GΩmin.at 500VDC.

Dielectric strength: 1,500 VAC rms.

Electrical life at full load: 500,000 cycles.

Operating temperature: -30°C to 85°C.

Panel thickness: 1.5 mm (.059) min. -4 mm (.157) max.

Total travel: 1.5 mm(.059)

Operating force: 3N~6N

Contact bounce: 10 ms.

Mechanical life: 1,000,000 cycles.

Torque : 0.5 Nm max. applied to nut

Degree of protection: IP68

Manual soldering:

Use soldering iron of 30 watts, controlled at 350°C approximately 5 seconds while applying solder.

Wave soldering:

Recommended soldering temperature: 260 ± 5°C

※Ambient temperature of the soldered surface of PCB.110°C max.

Duration of solder immersion: max 5 sec. (PCB is 1.6mm in thickness).

RS Part no.

175-8605	SP On-Mom. / Flat, Matte (Non LED) / Black Cap Color
175-8604	SP On-Mom. / Flat, Matte (Non LED) / Red Cap Color

Specifications:

<p>1. Style :</p> <p>This specification describes “Snap-Acting Pushbutton Switches”, mainly used as signal switch of electric devices, with the general requirements of mechanical and electrical characteristic.</p> <p>Operating Temperature Range : -30 °C~+85°C.</p>				
<p>2. Current Range :</p> <p>2.1 Silver Plating Standard :</p>				
Plating			Rating	
C=Gold over silver	Fixed Terminal : Copper alloy with silver plated over gold plate. Movable contact : Copper alloy with silver plated over gold plate.	400mA @32VAC Max. 125mA @125VAC Max. 200mA @50VDC Max.		
<p>3. Type of Actuation : Snap-Acting Pushbutton Switches.</p>				
<p>4. Test Sequence :</p>				
ELECTRIC PERFORMANCE	ITEM	DESCRIPTION	TEST CONDITIONS	REQUIREMENTS
	1	Visual Examination	By Visual Examination check without and out pressure & testing.	There shall be no defects that affect the serviceability of the product.
	2	Contact Resistance	To be measured between the two terminals associated with each switch pole.	50mΩ Max.
	3	Insulation Resistance	Measurements shall be made following application of 500 V/DC 100mA potential across terminals and cover for 1 minute.	1GΩ min/500V.
4	Dielectric Withstanding Voltage	1500 VAC(50Hz or 60Hz) Between the two terminals contacts for 1 minute.	There shall be no breakdown or flashover.	

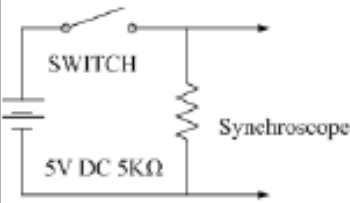
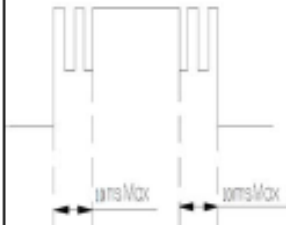
	ITEM	DESCRIPTION	TEST CONDITIONS	REQUIREMENTS
ELECTRIC PERFORMANCE	5	Bounce	<p>3 to 4 operations at a rate of 1 cycle per second.</p> 	<p>10 m seconds max.</p> 
	6	Actuation Force	<p>MODEL-1305N MECHANICAL TEST 500gram、1000gram、2000gram. OFF TO ON Total Travel.</p>	<p>① At for test the force. Force : 3N~6N. ② Total Travel : 1.5mm ③ Operating Position : 1.10mm±0.20mm</p>
MECHANICAL PERFORMANCE	7	Torque	Applied to nut.	About 0.5 Nm Max.
OPERATING LIFE	8	Operating Life	<p>Measurements shall be made following the test forth below :</p> <p>① Plastic Material : 200mA,50VDC resistive load-gold over silver plated.</p> <p>② Electronics Life Test : 500,000 cycles.</p> <p>③ Rate of Operation: 6-8 operation cycles per minute.</p>	<p>① Electronics Life Test : As shown in item 3~4.</p> <p>③ Mechanical Life Test : As shown in item 2~4.</p>
			<p>④ Mechanical Life Test : 1,000,000cycles.</p>	

ITEM	DESCRIPTION	TEST CONDITIONS	REQUIREMENTS
9	Resistance Low Temperature	Following the test set forth below the sample shall be left in normal temperature and humidity conditions for 1 hour before the measurements are made : ① Temperature : $-30\pm 3^{\circ}\text{C}$. ② Time : 96 hours.	As shown in item 2~4.
10	Resistance High Temperature	Following the test set forth below the sample shall be left in normal temperature and humidity conditions for an hour before the measurements are made : ① Temperature : $85\pm 3^{\circ}\text{C}$. ② Time : 96 hours.	As shown in item 2~4.
11	Resistance Humidity	Following the test set forth below the sample shall be left in normal temperature and humidity conditions for an hour before the measurements are made : ① Temperature : $40\pm 2^{\circ}\text{C}$. ② Relative Humidity : 90~95%. ③ Time : 96 hours.	① Contact Resistance : $50\text{m}\Omega$ Max. ② Insulation Resistance : $1\text{G}\Omega$ min.
12	The Salt Testing	Following the test set forth below the sample shall be left in normal temperature and humidity conditions for an hour before the measurements are made : ① Temperature : $35\pm 2^{\circ}\text{C}$. ② The ratio of salt-water : 5%. ③ The spray amount of salt-water : 1~2 ml/h. ④ Time : 48 hours.	The testing standard based on bubble, crack, and magnifying glass with gauge.

HUMIDITY RESISTANCE

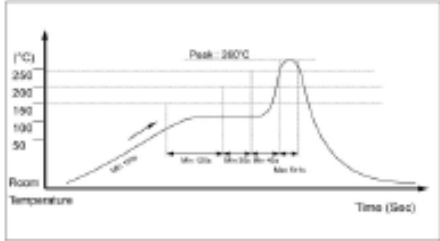
	ITEM	DESCRIPTION	TEST CONDITIONS	REQUIREMENTS
HUMIDITY RESISTANCE	13	HSF	Refer RoHS Standard : The electronic electrical machinery product limits with six big chemical materials.	Cd : 100ppm Pb : 1000ppm Hg : 1000ppm Cr6+ : 1000ppm PBB 、 PBDE : 1000ppm
	14	Test of IP 68	Protected against the effects of continuous immersion in water at a depth 1 m /60 minutes.	IP68 According to EN 60529 : 1991 + A1 : 2000 IEC 60529 : 2001
SOLDER HEAT RESISTANCE	15	Wave Soldering	<p>■ Wave Soldering :</p> <p>① Soldering Temperature: $260 \pm 5^{\circ}\text{C}$.</p> <p>② Duration of Solder Immersion: 5 ± 1 seconds.</p> <p>Temperature Profile</p>  <p>③ PCB is 1.6mm in thickness.</p> <p>■ Ambient temperature of the soldered Surface of PC board. 110°C Max.</p>	<p>① Shall be free from pronounced backlash and falling-off or breakage terminals.</p> <p>② As shown in item 2~4.</p>

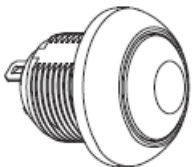
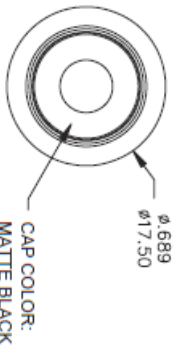

MATERIALS
 CAP: Polyamide 6/6.
 PLUNGER: Polyamide 6/6.
 RUBBER: Silicone.
 BUSHING: Polyamide 6/6.
 CASE: Dialyl phthalate (DAP)(UL 94V-0).
 TERMINAL/CONTACTS: Gold over silver plated.
 ROHS & Lead Free

PART NO.	PART NAME	QTY
1	MNU-PA03	1
2	MNU-1M09	1
3	FCP-A293	1

FILE NAME: HARDWARE-0086

Model No.	POS.1	POS.2
PFST	ON	MOM(OFF)
CONNECTED TERMINALS	CLOSE	OPEN
SCHEMATIC		

SWITCH FUNCTION

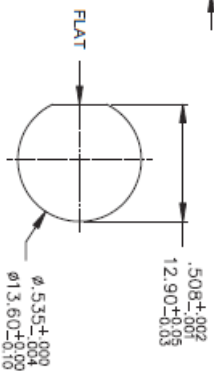
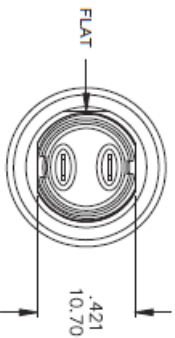
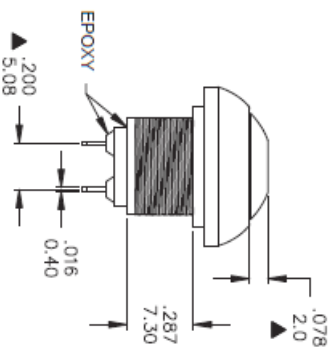
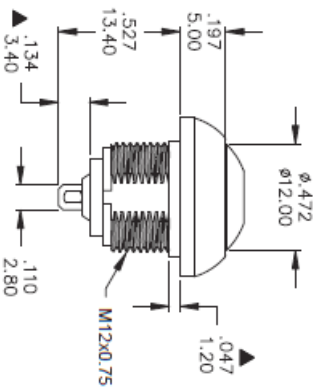

PANEL CUT-OUT
 THICKNESS: 1.5 mm ~ 4.0 mm

TOLERANCE:
 0.00 mm ± 0.25mm
 0.0 mm ± 0.40mm
 ANGULAR : ± 5°

SPECIFICATIONS

Max. current/voltage rating with resistive load:
 400mA 32VAC - 200 mA 50VDC - 125 mA 125VAC.
 INITIAL CONTACT RESISTANCE: 50 mΩ max.
 INSULATION RESISTANCE: 1 GΩ min. at 500VDC.
 DIELECTRIC STRENGTH: 1,500 VAC rms.
 ELECTRICAL LIFE AT FULL LOAD: 500,000 cycles.
 TOTAL TRAVEL: 1.5 mm(.059).
 OPERATING FORCE: 3N~6N.
 CONTACT BOUNCE: 10 ms.
 MECHANICAL LIFE: 1,000,000 cycles.
 TORQUE: 0.5 Nm max. applied to nut.
 SOLDERING: 350°C max. for 5 seconds.
 OPERATING TEMPERATURE: -30°C to 85°C.
 DEGREE OF PROTECTION: IP68