



Every part matters

EN

RS Pro 4PDT 24V Polarised PCB Mount Relay

Stock Number: 193-5864

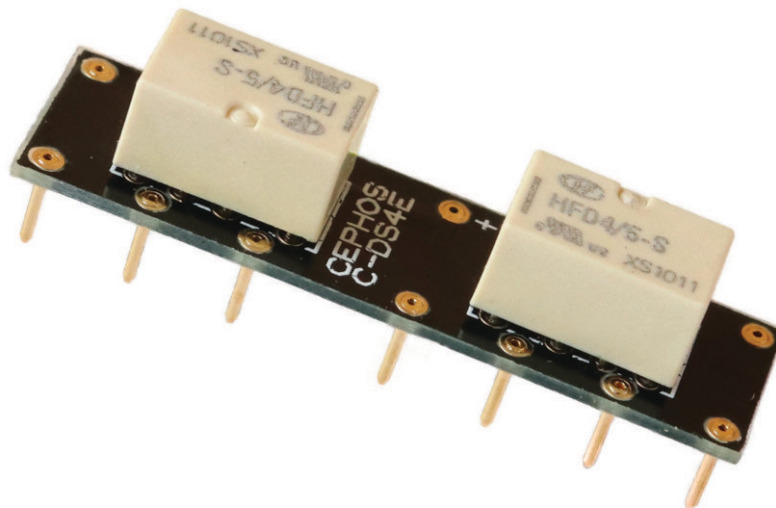

The RS Pro 4PDT 24V polarised PCB mount relay is a drop in alternative solution to the obsolete Panasonic DS4E, Omron G6A-434P, Fujitsu RA4 and IMO EN4-CW relays.



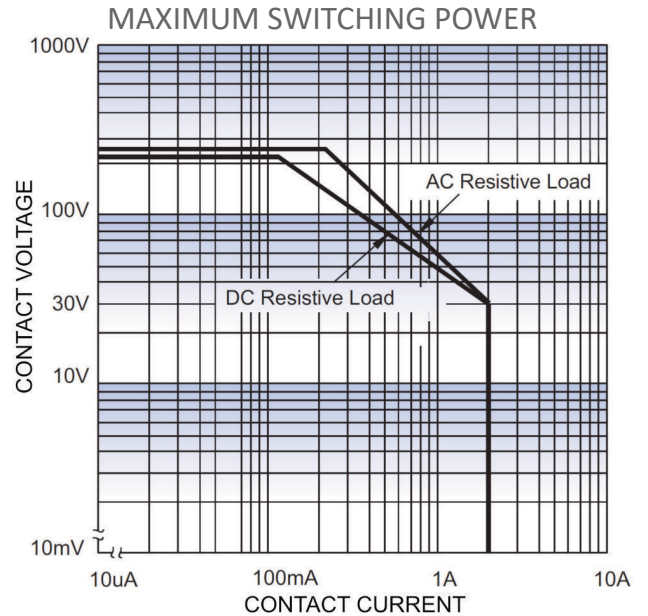
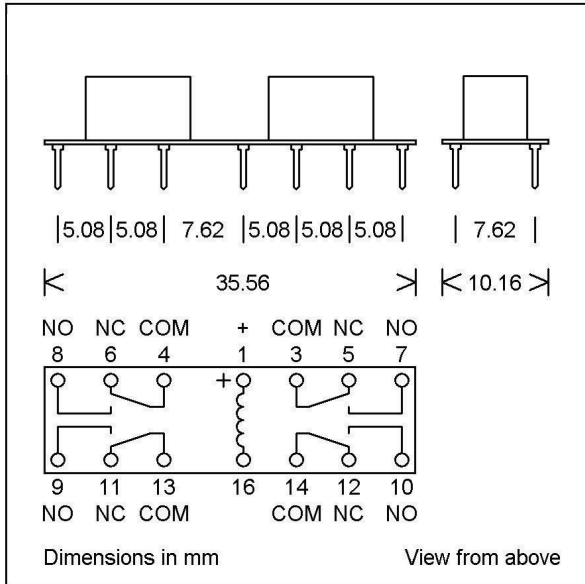

Contact Data	
Contact arrangement	4 pole C/O
Contact resistance	100mΩ max at 10mA / 30mVdc
Contact material	AgNi + Au plated
Contact rating (Res. Load)	1A 30Vdc 0.5A 125Vac
Max. switching current	2A
Max. Switching voltage	250Vac / 220Vdc
Max. Switching power	62.5VA / 60W
Min. Applicable load	10mV 10μA
Mechanical endurance	1 x 10 ⁸ ops
Electrical endurance	1 x 10 ⁵ ops (AgNi + Au plated, 0.5A 125Vac, resistive load, at 40°C, 1s on 9s off)

Characteristics	
Operate time	3ms max.
Release time	3ms max.
Ambient temperature	-40°C to 85°C
Humidity	5% to 85% RH
Unit weight	2.54g
Coil Data (5V)	
Pick-up voltage Vdc max.	18V
Drop-out voltage Vdc min.	2.4V
Coil resistance Ω	1440Ω
Nominal power mW	400mW
Max voltage Vdc	36V