



ENGLISH

## Datasheet

# RS PRO Straight Plug Male 4 pin Solder Brass OD 2.7-3.5mm

Stock No: 209-5655



RS Pro's range of Chrome plated Brass push-pull locking connectors offer exceptional quality that is found in many cutting-edge connectors, including full 360° EMC shielding and high mating life. As has become standard within the RS Pro brand you can expect high quality products but at a reasonable price. These connectors are ideal for use in medical devices, testing equipment, audio equipment and other high-end indoor applications.

## Features & Benefits:

- Push-pull latching system
- Chrome plated Brass
- IP50
- 360° Screening for full EMC shielding
- 2A Current Rating

### Technical

Characteristics	Value	Standard
Endurance	>5000cycles	IEC60512-5test9a
Humidity	Up to 95% at 60°C	
Temperature range	-55°C, +250°C	
Resistance to vibration	10-2000Hz,15g	IEC 60512-4 test 6d
Shock resistance	100g, 6ms	IEC 60512-4 test 6c
Salt spray corrosion test	>96hrs	IEC 60512-6 test 11f
Protection index (mated)	IP50	IEC 60529
Climatical category	55/175/21	IEC 60068-1

### Electrical

Characteristics		Value	Standard
Shielding efficiency	at 10MHZ	>75 dB	IEC 60619-1-3
	at 1GHZ	>40 dB	IEC 60619-1-3

# Dimensional line drawings

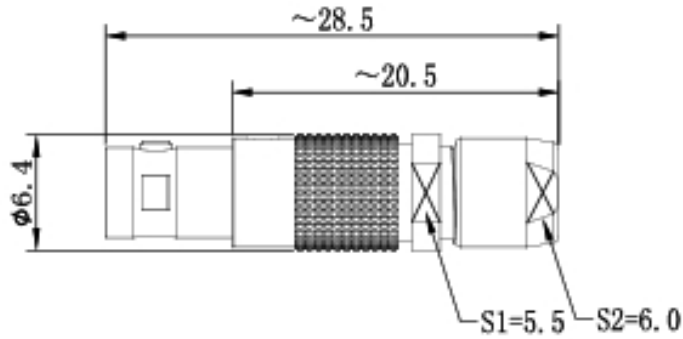

CONNECTOR SOLDER CUP VIEW

● — RED



## Quality Standards

