

## FEATURES

- Dropout Voltage: 0.6V at  $I_{OUT} = 3A$
- Fast Transient Response
- Output Current: 3A
- Quiescent Current: 400 $\mu$ A
- No Protection Diodes Needed
- Fixed Output Voltage: 3.3V
- Controlled Quiescent Current in Dropout
- Shutdown  $I_Q = 125\mu$ A
- Stable with 3.3 $\mu$ F Output Capacitor
- Reverse Battery Protection
- No Reverse Output Current
- Thermal Limiting

## APPLICATIONS

- Microprocessor Applications
- Post Regulator for Switching Supplies
- 5V to 3.3V Logic Regulator

## DESCRIPTION

The LT<sup>®</sup>1528 is a 3A low dropout regulator optimized to handle the large load current transients associated with the current generation of microprocessors. This device has the fastest transient response of currently available PNP regulators and is very tolerant of variations in capacitor ESR. Dropout voltage is 75mV at 10mA, rising to 300mV at 1A and 600mV at 3A. The device has a quiescent current of 400 $\mu$ A. Quiescent current is well controlled; it does not increase significantly as the device enters dropout. The regulator can operate with output capacitors as small as 3.3 $\mu$ F, although larger capacitors will be needed to achieve the performance required in most microprocessor applications. The LT1528 is available with a fixed output voltage of 3.3V. An external SENSE pin allows adjustment to output voltages greater than 3.3V, using a simple resistive divider. This allows the device to be adjusted over a wide range of output voltages, including the 3.3V to 4.2V range required by a variety of processors from Intel, IBM, AMD, and Cyrix.

The LT1528 has both reverse input and reverse output protection and includes a shutdown feature. Quiescent current drops to 125 $\mu$ A in shutdown. The LT1528 is available in 5-lead TO-220 and 5-lead DD-PAK packages.

LT, LT, LTC and LTM are registered trademarks of Linear Technology Corporation. All other trademarks are the property of their respective owners.

## TYPICAL APPLICATION

Microprocessor Supply with Shutdown

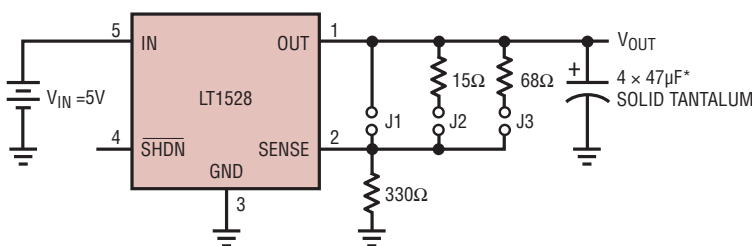

$V_{SHDN}$ (PIN 4)	OUTPUT
<0.25	OFF
>2.80	ON
NC	ON

SHORTING	$V_{OUT}$
J1	3.30
J2	3.45
J3	4.00

\*CHOOSE CAPACITORS TO MEET PROCESSOR REQUIREMENTS

1528 TA01

Dropout Voltage

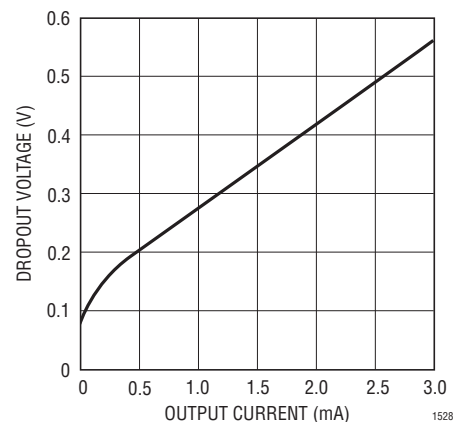

1528 TA02

1528fb

# LT1528

## ABSOLUTE MAXIMUM RATINGS

(Note 1)

Input Voltage.....	$\pm 15V^*$
OUTPUT Pin Reverse Current .....	10mA
SENSE Pin Current.....	10mA
SHDN Pin Input Voltage (Note 2).....	6.5V, $-0.3V$
SHDN Pin Input Current (Note 2).....	5mA

Output Short-Circuit Duration .....	Indefinite
Storage Temperature Range.....	$-65^{\circ}C$ to $150^{\circ}C$
Operating Junction Temperature Range	
LT1528C.....	$0^{\circ}C$ to $125^{\circ}C$
Lead Temperature (Soldering, 10 sec) .....	$300^{\circ}C$

\*For applications requiring input voltage ratings greater than 15V, contact the factory.

## PIN CONFIGURATION

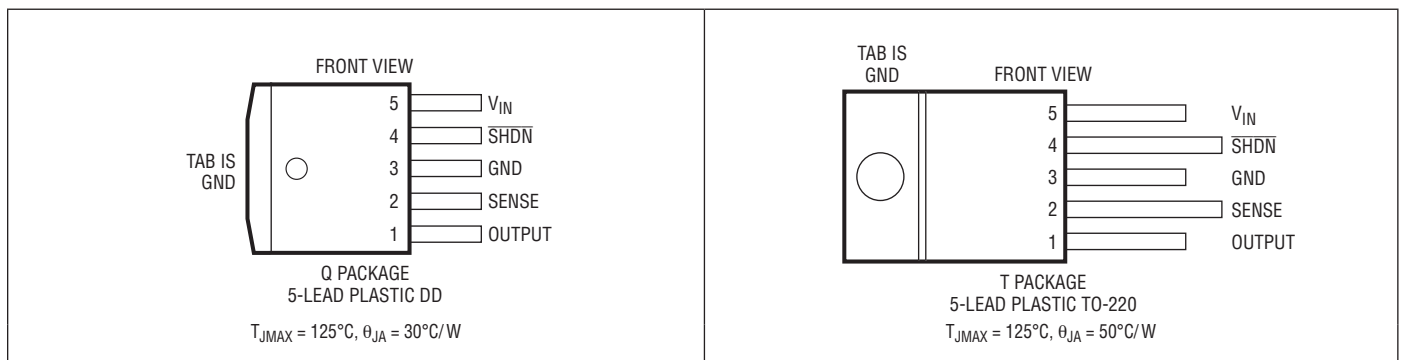

## ORDER INFORMATION

LEAD FREE FINISH	TAPE AND REEL	PART MARKING	PACKAGE DESCRIPTION	TEMPERATURE RANGE
LT1528CQ#PBF	LT1528CQ#TRPBF	LT1528CQ	5-Lead Plastic DD-PAK	$0^{\circ}C$ to $125^{\circ}C$
LT1528CT#PBF	LT1528CT#TRPBF	LT1528CT	5-Lead Plastic TO-220	$0^{\circ}C$ to $125^{\circ}C$
LEAD BASED FINISH	TAPE AND REEL	PART MARKING	PACKAGE DESCRIPTION	TEMPERATURE RANGE
LT1528CQ	LT1528CQ#TR	LT1528CQ	5-Lead Plastic DD-PAK	$0^{\circ}C$ to $125^{\circ}C$
LT1528CT	LT1528CT#TR	LT1528CT	5-Lead Plastic TO-220	$0^{\circ}C$ to $125^{\circ}C$

Consult LTC Marketing for parts specified with wider operating temperature ranges.

For more information on lead free part marking, go to: <http://www.linear.com/leadfree/>

For more information on tape and reel specifications, go to: <http://www.linear.com/tapeandreel/>

## ELECTRICAL CHARACTERISTICS

The ● denotes the specifications which apply over the full operating temperature range, otherwise specifications are at  $T_J = 25^{\circ}C$ .

PARAMETER	CONDITIONS	MIN	TYP	MAX	UNITS
Regulated Output Voltages (Notes 3, 4)	$V_{IN} = 3.8V, I_{OUT} = 1mA$	3.250	3.300	3.350	V
	$4.3V < V_{IN} < 15V, 1mA < I_{OUT} < 3A$	● 3.200	3.300	3.400	V
Line Regulation (Note 4)	$\Delta V_{IN} = 3.8V$ to $15V, I_{OUT} = 1mA$	●	1.5	1.0	mV
Load Regulation (Note 4)	$\Delta I_{LOAD} = 1mA$ to $3A, V_{IN} = 4.3V$	●	12	20	mV
	$\Delta I_{LOAD} = 1mA$ to $3A, V_{IN} = 4.3V$	●	15	30	mV
Dropout Voltage (Note 5)	$I_{LOAD} = 10mA$	●	70	110	mV
	$I_{LOAD} = 10mA$	●		150	mV

1528fb

**ELECTRICAL CHARACTERISTICS** The ● denotes the specifications which apply over the full operating temperature range, otherwise specifications are at  $T_J = 25^\circ\text{C}$ .

PARAMETER	CONDITIONS	MIN	TYP	MAX	UNITS
Dropout Voltage (Note 5)	$I_{LOAD} = 100\text{mA}$ $I_{LOAD} = 100\text{mA}$ ●		150	200 250	mV mV
	$I_{LOAD} = 700\text{mA}$ $I_{LOAD} = 700\text{mA}$ ●		280	320 420	mV mV
	$I_{LOAD} = 1.5\text{A}$ $I_{LOAD} = 1.5\text{A}$ ●		390	450 600	mV mV
	$I_{LOAD} = 3\text{A}$ $I_{LOAD} = 3\text{A}$ ●		570	670 850	mV mV
GND Pin Current (Note 6)	$I_{LOAD} = 0\text{mA}$ $I_{LOAD} = 0\text{mA}, T_J = 125^\circ\text{C}$ (Note 7)		450 1.9	750	$\mu\text{A}$ mA
	$I_{LOAD} = 100\text{mA}$ $I_{LOAD} = 100\text{mA}, T_J = 125^\circ\text{C}$ (Note 7)		1.2 2.7	2.5	mA mA
	$I_{LOAD} = 300\text{mA}$ $I_{LOAD} = 300\text{mA}, T_J = 125^\circ\text{C}$ (Note 7)		2.6 4.1	4.0	mA mA
	$I_{LOAD} = 700\text{mA}$ $I_{LOAD} = 700\text{mA}, T_J = 125^\circ\text{C}$ (Note 7)		7.3 8.8	12.0	mA mA
	$I_{LOAD} = 1.5\text{A}$ ●		22	40	mA
	$I_{LOAD} = 3\text{A}$ ●		85	140	mA
SENSE Pin Current (Notes 4, 8)		90	130	250	$\mu\text{A}$
SHDN Threshold	$V_{OUT} = \text{Off-to-On}$ ●		1.20	2.80	V
	$V_{OUT} = \text{On-to-Off}$ ●	0.25	0.75		V
SHDN Pin Current (Note 9)	$V_{SHDN} = 0\text{V}$ ●		37	100	$\mu\text{A}$
Quiescent Current in Shutdown (Note 10)	$V_{IN} = 6\text{V}, V_{SHDN} = 0\text{V}$ ●		110	220	$\mu\text{A}$
Ripple Rejection	$V_{IN} - V_{OUT} = 1\text{V(Avg)}, V_{RIPPLE} = 0.5\text{V}_{P-P}$ , $f_{RIPPLE} = 120\text{Hz}, I_{LOAD} = 1.5\text{A}$		50	67	dB
Current Limit	$V_{IN} - V_{OUT} = 7\text{V}$ $V_{IN} = 4.3\text{V}, \Delta V_{OUT} = -0.1\text{V}$ ●		3.2	4.5 4.0	A A
	$V_{IN} = -15\text{V}, V_{OUT} = 0\text{V}$ ●			1.0	mA
Reverse Output Current (Note 11)	$V_{OUT} = 3.3\text{V}, V_{IN} = 0\text{V}$		120	250	$\mu\text{A}$

**Note 1:** Stresses beyond those listed under Absolute Maximum Ratings may cause permanent damage to the device. Exposure to any Absolute Maximum Rating condition for extended periods may affect device reliability and lifetime.

**Note 2:** The SHDN pin input voltage rating is required for a low impedance source. Internal protection devices connected to the SHDN pin will turn on and clamp the pin to approximately 7V or -0.6V. This range allows the use of 5V logic devices to drive the pin directly. For high impedance sources or logic running on supply voltages greater than 5.5V, the maximum current driven into the SHDN pin must be less than 5mA.

**Note 3:** Operating conditions are limited by maximum junction temperature. The regulated output voltage specification will not apply for all possible combinations of input voltage and output current. When operating at maximum input voltage, the output current must be limited. When operating at maximum output current, the input voltage range must be limited.

**Note 4:** The LT1528 is tested and specified with the SENSE pin connected to the OUTPUT pin.

**Note 5:** Dropout voltage is the minimum input/output voltage required to

maintain regulation at the specified output current. In dropout the output voltage will be equal to:  $(V_{IN} - V_{DROPOUT})$ .

**Note 6:** GND pin current is tested with  $V_{IN} = V_{OUT}$  (nominal) and a current source load. This means that the device is tested while operating in its dropout region. This is the worst-case GND pin current. The GND pin current will decrease slightly at higher input voltages.

**Note 7:** GND pin current will rise at  $T_J > 75^\circ\text{C}$ . This is due to internal circuitry designed to compensate for leakage currents in the output transistor at high temperatures. This allows quiescent current to be minimized at lower temperatures, yet maintain output regulation at high temperatures with light loads. See quiescent current curve in typical performance characteristics section.

**Note 8:** SENSE pin current flows into the SENSE pin.

**Note 9:** SHDN pin current at  $V_{SHDN} = 0\text{V}$  flows out of the SHDN pin.

**Note 10:** Quiescent current in shutdown is equal to the total sum of the SHDN pin current (40 $\mu\text{A}$ ) and the GND pin current (70 $\mu\text{A}$ ).

**Note 11:** Reverse output current is tested with the input pin grounded and the OUTPUT pin forced to the rated output voltage. This current flows into the OUTPUT pin and out of the GND pin.

TYPICAL PERFORMANCE CHARACTERISTICS

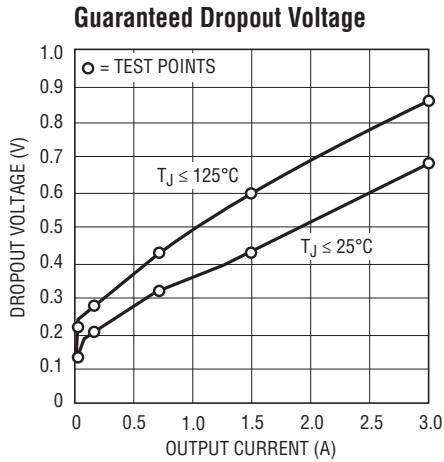

1528 TPC01

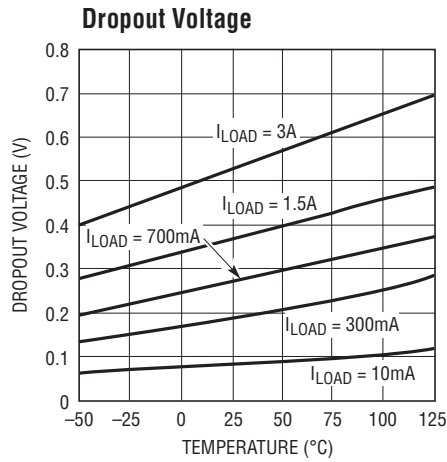

1528 TPC02

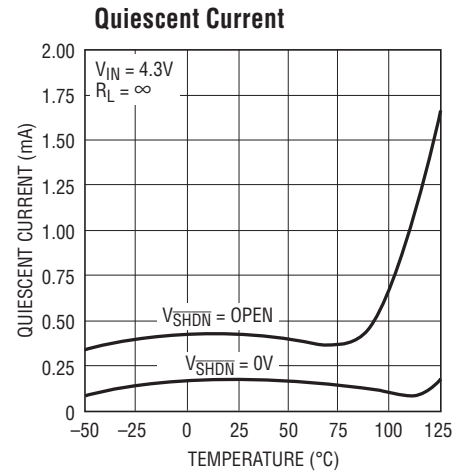

1528 TPC03

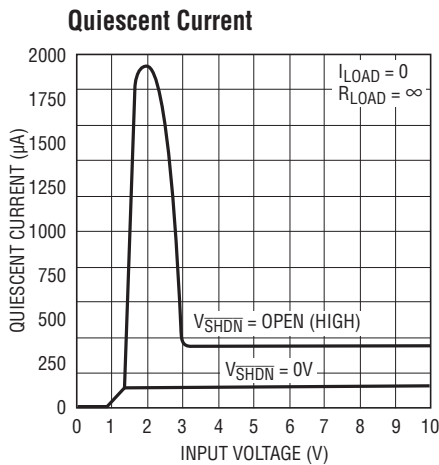

1528 TPC04

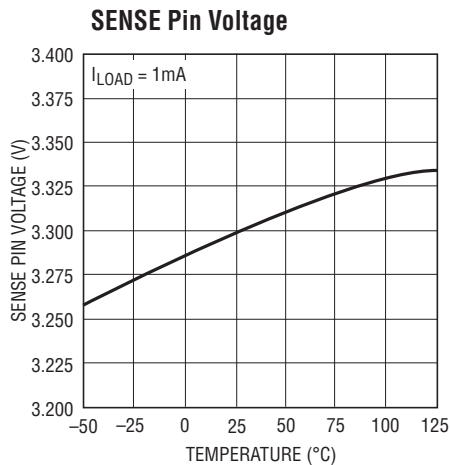

1528 TPC05

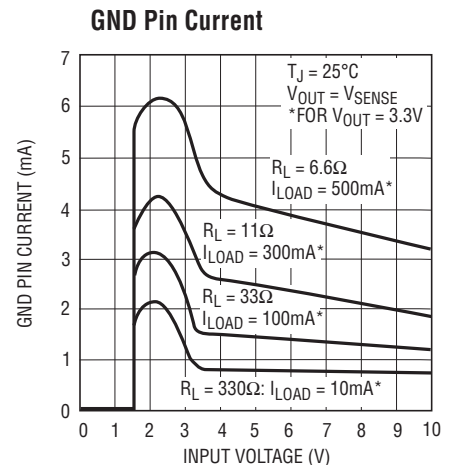

1528 TPC06

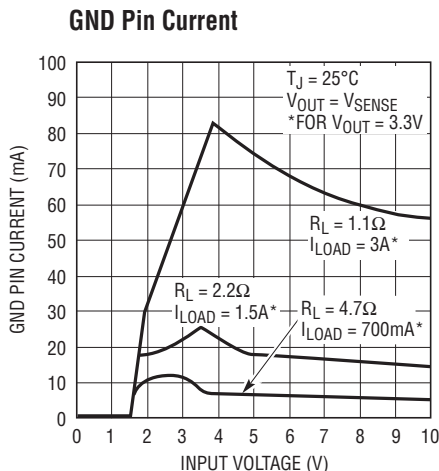

1528 TPC07

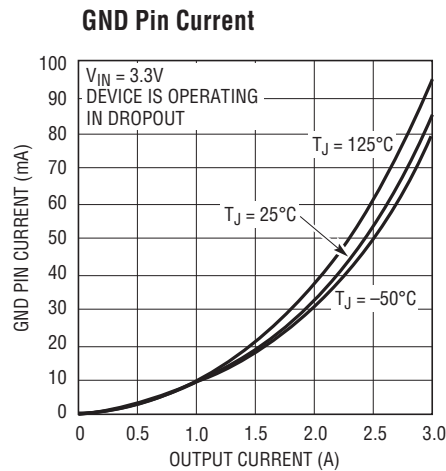

1528 TPC08

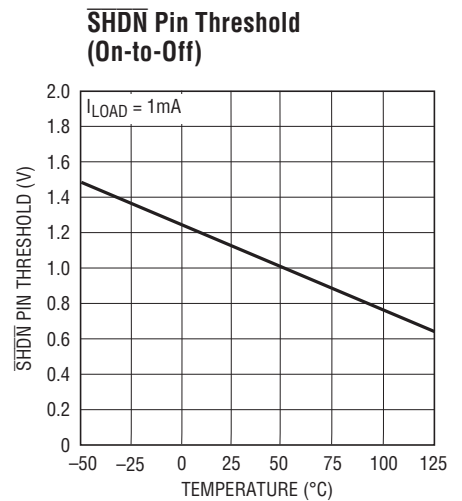

1528 TPC09

# TYPICAL PERFORMANCE CHARACTERISTICS

**SHDN Pin Threshold (Off-to-On)**

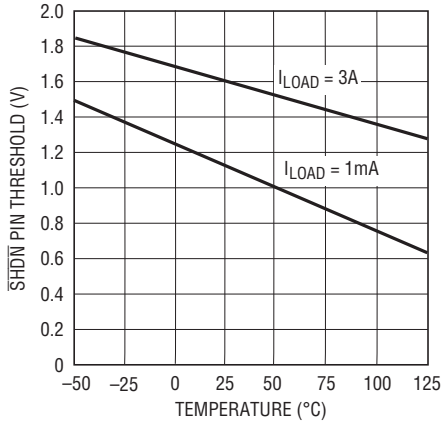

1528 TPC10

**SHDN Pin Current**

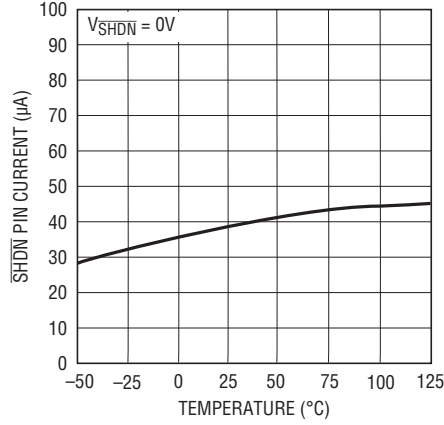

1528 TPC11

**SHDN Pin Input Current**

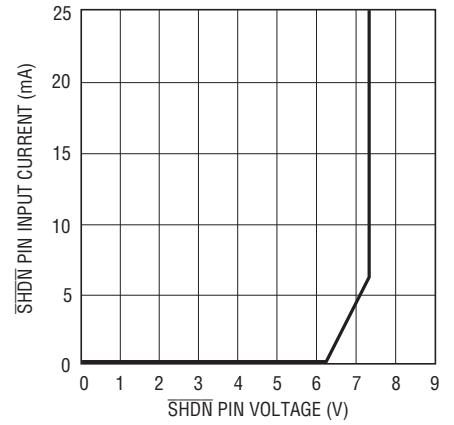

1528 TPC12

**SENSE Pin Current**

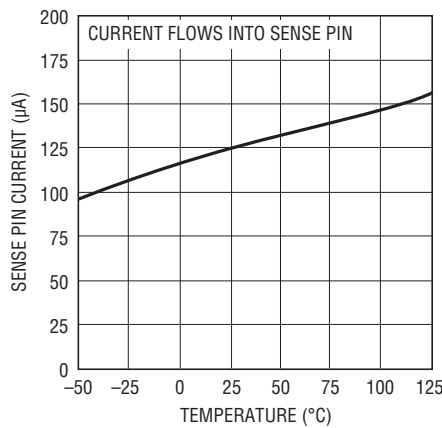

1528 TPC13

**Reverse Output Current**

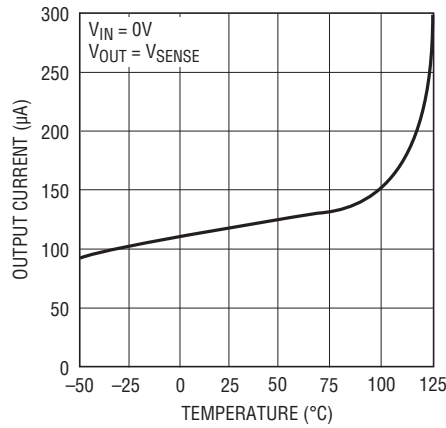

1528 TPC14

**Current Limit**

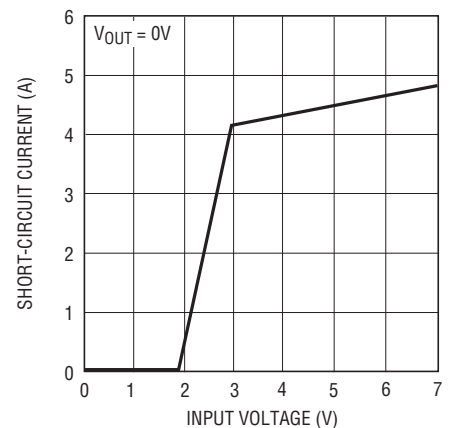

1528 TPC15

**Current Limit**

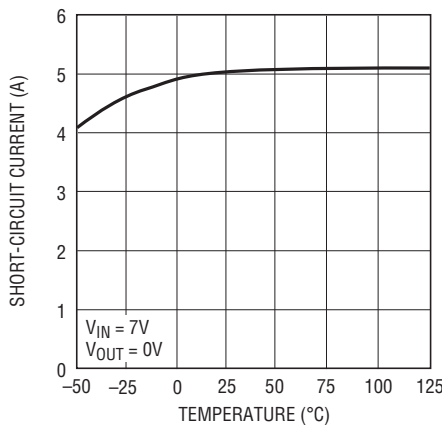

1528 TPC16

**Reverse Output Current**

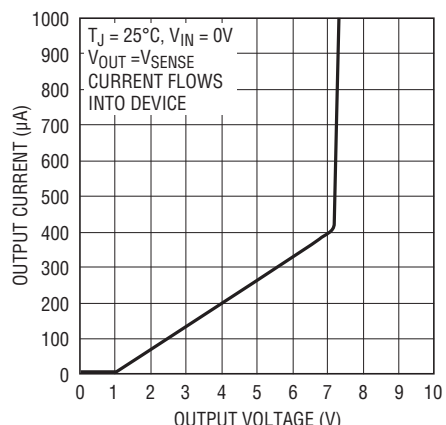

1528 TPC17

**Ripple Rejection**

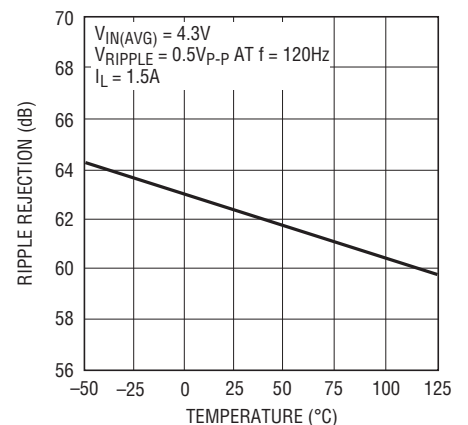

1528 TPC18

## TYPICAL PERFORMANCE CHARACTERISTICS

Ripple Rejection

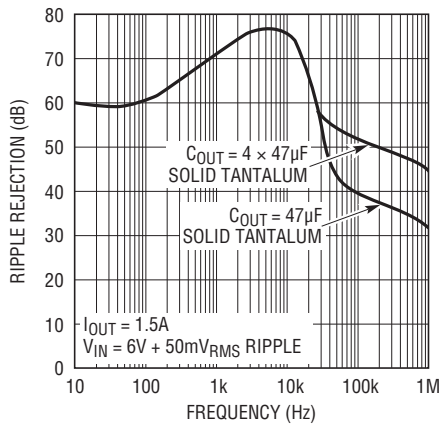

1528 TPC19

Load Regulation

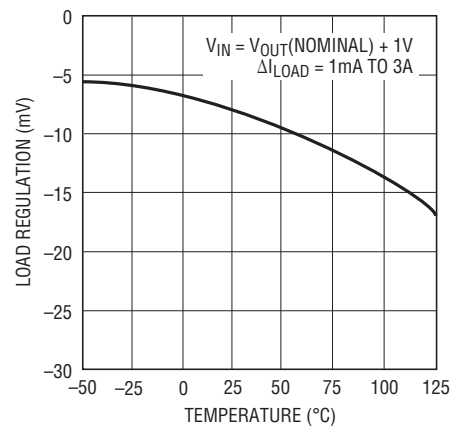

1528 TPC20

Transient Response

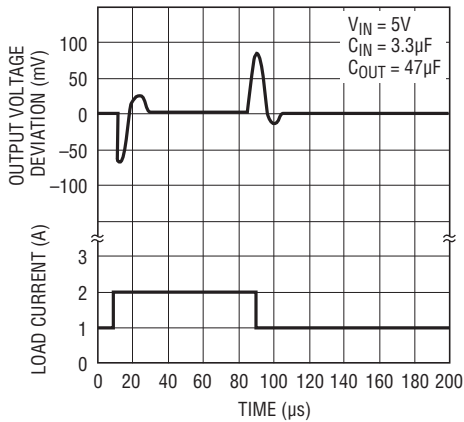

1528 TPC21

Transient Response

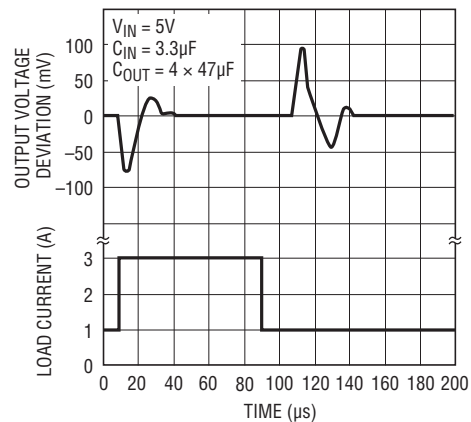

1528 TPC22

## PIN FUNCTIONS

**OUTPUT (Pin 1):** The OUTPUT pin supplies power to the load. A minimum output capacitor of  $3.3\mu F$  is required to prevent oscillations. Larger values will be needed to achieve the transient performance required by high speed microprocessors. See the Applications Information section for more on output capacitance and reverse output characteristics.

**SENSE (Pin 2):** The SENSE pin is the input to the error amplifier. Optimum regulation will be obtained at the point where the SENSE pin is connected to the OUTPUT pin. For most applications the SENSE pin is connected directly to the OUTPUT pin at the regulator. In critical applications small voltage drops caused by the resistance ( $R_P$ ) of PC traces between the regulator and the load, which would

normally degrade regulation, may be eliminated by connecting the SENSE pin to the OUTPUT pin at the load as shown in Figure 1 (Kelvin Sense Connection). Note that the voltage drop across the external PC traces will add to the dropout voltage of the regulator. The SENSE pin bias current is  $150\mu A$  at the nominal regulated output voltage. See SENSE Pin Current vs Temperature in the Typical Performance Characteristics section. This pin is internally clamped to  $-0.6V$  (one  $V_{BE}$ ).

The SENSE pin can also be used with a resistor divider to achieve output voltages above 3.3V. See the Applications Information section for information on adjustable operation.

## PIN FUNCTIONS

**SHDN (Pin 4):** This pin is used to put the device into shutdown. In shutdown the output of the device is turned off. This pin is active low. The device will be shut down if the SHDN pin is actively pulled low. The SHDN pin current with the pin pulled to ground will be 60µA. The SHDN pin is internally clamped to 7V and -0.6V (one  $V_{BE}$ ). This allows the SHDN pin to be driven directly by 5V logic or by open collector logic with a pull-up resistor. The pull-up resistor is only required to supply the leakage current of the open collector gate, normally several microamperes. Pull-up current must be limited to a maximum of 5mA. A curve of SHDN pin input current as a function of voltage appears in the Typical Performance Characteristics section. If the SHDN pin is not used it can be left open circuit. The device will be active output on if the SHDN pin is not connected.

**V<sub>IN</sub> (Pin 5):** Power is supplied to the device through the input pin. The input pin should be bypassed to ground if

the device is more than six inches away from the main input filter capacitor. The LT1528 is designed to withstand reverse voltages on the input pin with respect to ground and the OUTPUT pin. In the case of reversed input, the LT1528 will act as if there is a diode in series with its input. There will be no reverse current flow into the LT1528 and no reverse voltage will appear at the load. The device will protect both itself and the load.

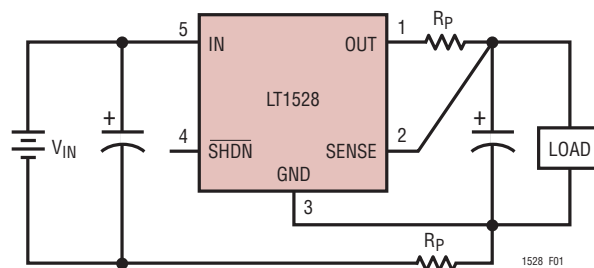

Figure 1. Kelvin Sense Connection

## APPLICATIONS INFORMATION

The LT1528 is a 3A low dropout regulator optimized for microprocessor applications. Dropout voltage is only 0.6V at 3A output current. With the SENSE pin shorted to the OUTPUT pin, the output voltage is set to 3.3V. The device operates with a quiescent current of 400µA. In shutdown, the quiescent current drops to only 125µA. The LT1528 incorporates several protection features, including protection against reverse input voltages. If the output is held at the rated output voltage when the input is pulled to ground, the LT1528 acts like it has a diode in series with its output and prevents reverse current flow.

### Adjustable Operation

The LT1528 can be used as an adjustable regulator with an output voltage range of 3.3V to 14V. The output voltage is set by the ratio of two external resistors as shown in Figure 2. The device servos the output voltage to maintain the voltage at the SENSE pin at 3.3V. The current in R1 is then equal to 3.3V/R1. The current in R2 is equal to the sum of the current in R1 and the SENSE pin current. The SENSE pin current, 130µA at 25°C, flows through R2

into the SENSE pin. The output voltage can be calculated using the formula in Figure 2. The value of R1 should be less than 330Ω to minimize errors in the output voltage caused by the SENSE pin current. Note that in shutdown the output is turned off and the divider current will be zero. Curves of SENSE Pin Voltage vs Temperature and SENSE Pin Current vs Temperature appear in the Typical Performance Characteristics section.

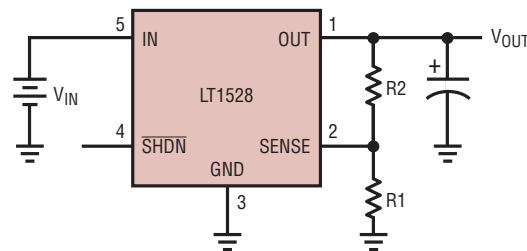

$$V_{OUT} = 3.3V \left( 1 + \frac{R_2}{R_1} \right) + (I_{SENSE})(R_2)$$

$$V_{SENSE} = 3.3V$$

$$I_{SENSE} = 130\mu A \text{ AT } 25^\circ C$$

$$\text{OUTPUT RANGE} = 3.3V \text{ TO } 14V$$

1528 F02

Figure 2. Adjustable Operation

## APPLICATIONS INFORMATION

The LT1528 is specified with the SENSE pin tied to the OUTPUT pin. This sets the output voltage to 3.3V. Specifications for output voltage greater than 3.3V will be proportional to the ratio of the desired output voltage to 3.3V ( $V_{OUT}/3.3V$ ). For example, load regulation for an output current change of 1mA to 1.5A is  $-5mV$  (typical) at  $V_{OUT} = 3.3V$ . At  $V_{OUT} = 12V$ , load regulation would be:

$$(12V/3.3V) \cdot (-5mV) = (-18mV)$$

### Thermal Considerations

The power handling capability of the device will be limited by the maximum rated junction temperature ( $125^{\circ}C$ ). The power dissipated by the device will be made up of two components:

1. Output current multiplied by the input/output voltage differential,  $I_{OUT} \cdot (V_{IN} - V_{OUT})$ , and
2. GND pin current multiplied by the input voltage,  $I_{GND} \cdot V_{IN}$ .

The GND pin current can be found by examining the GND Pin Current curves in the Typical Performance Characteristics. Power dissipation will be equal to the sum of the two components listed above.

The LT1528 has internal thermal limiting designed to protect the device during overload conditions. For continuous normal load conditions the maximum junction temperature rating of  $125^{\circ}C$  must not be exceeded. It is important to give careful consideration to all sources of thermal resistance from junction-to-ambient. Additional heat sources mounted nearby must also be considered.

For surface mount devices heat sinking is accomplished by using the heat spreading capabilities of the PC board and its copper traces. Experiments have shown that the heat spreading copper layer does not have to be electrically connected to the tab of the device. The PC material can be very effective at transmitting heat between the pad area, attached to the tab of the device, and a ground or power plane either inside or on the opposite side of the board. Although the actual thermal resistance of the PC material is high, the length/area ratio of the thermal resistor between layers is small. Copper board stiffeners and plated through holes can also be used to spread the heat generated by power devices.

Table 1a lists thermal resistance for the DD package. For the TO-220 package (Table 1b) thermal resistance is given for junction-to-case only since this package is usually mounted to a heat sink. Measured values of thermal resistance for several different copper areas are listed for the DD package. All measurements were taken in still air on 3/32" FR-4 board with one ounce copper. This data can be used as a rough guideline in estimating thermal resistance. The thermal resistance for each application will be affected by thermal interactions with other components as well as board size and shape. Some experimentation will be necessary to determine the actual value.

**Table 1a. Q-Package, 5-Lead DD**

COPPER AREA		BOARD AREA	THERMAL RESISTANCE (JUNCTION-TO-AMBIENT)
TOPSIDE*	BACKSIDE		
2500 sq mm	2500 sq mm	2500 sq mm	$23^{\circ}C/W$
1000 sq mm	2500 sq mm	2500 sq mm	$25^{\circ}C/W$
125 sq mm	2500 sq mm	2500 sq mm	$33^{\circ}C/W$

\*Device is mounted on topside.

**Table 1b. T Package, 5-Lead TO-220**

Thermal Resistance (Junction-to-Case)	$2.5^{\circ}C/W$
---------------------------------------	------------------

### Calculating Junction Temperature

Example: Given an output voltage of 3.3V, an input voltage range of 4.5V to 5.5V, an output current range of 0mA to 500mA and a maximum ambient temperature of  $50^{\circ}C$ , what will the maximum junction temperature be?

The power dissipated by the device will be equal to:

$$I_{OUT(MAX)} \cdot (V_{IN(MAX)} - V_{OUT}) + [I_{GND} \cdot V_{IN(MAX)}]$$

where,

$$I_{OUT(MAX)} = 500mA$$

$$V_{IN(MAX)} = 5.5V$$

$$I_{GND} \text{ at } (I_{OUT} = 500mA, V_{IN} = 5.5V) = 4mA$$

so,

$$P = 500mA \cdot (5.5V - 3.3V) + (4mA \cdot 5.5V) = 1.12W$$

If we use a DD package, the thermal resistance will be in the range of  $23^{\circ}C/W$  to  $33^{\circ}C/W$  depending on the copper area. So the junction temperature rise above ambient will be approximately equal to:

$$1.12W \cdot 28^{\circ}C/W = 31.4^{\circ}C$$



## APPLICATIONS INFORMATION

The maximum junction temperature will be equal to the maximum junction temperature rise above ambient plus the maximum ambient temperature or:

$$T_{JMAX} = 50^{\circ}\text{C} + 31.4^{\circ}\text{C} = 81.4^{\circ}\text{C}$$

### Output Capacitance and Transient Performance

The LT1528 is designed to be stable with a wide range of output capacitors. The minimum recommended value is 3.3μF with an ESR of 2Ω or less. The LT1528 output transient response will be a function of output capacitance. See the Transient Response curves in the Typical Performance Characteristics. Larger values of output capacitance will decrease the peak deviations and provide improved output transient response for larger load transients. Bypass capacitors, used to decouple individual components powered by the LT1528, will increase the effective value of the output capacitor.

### Microprocessor Applications

The LT1528 has been optimized for microprocessor applications, with the fastest transient response of current PNP low dropout regulators. In order to deal with the large load transients associated with current generation microprocessors, output capacitance must be increased. To meet worst-case voltage specifications for many popular processors, four 47μF solid tantalum surface mount capacitors are recommended for decoupling at the microprocessor. These capacitors should have an ESR of approximately 0.1Ω to 0.2Ω to minimize transient response under worst-case load deltas. The Typical Application shows connections needed to supply power for

several different processors. This application allows the output voltage to be jumper selectable.

### Protection Features

The LT1528 incorporates several protection features, such as current limiting and thermal limiting, in addition to the normal protection features associated with monolithic regulators. The device is protected against reverse input voltages and reverse voltages from output to input.

Current limit protection and thermal overload protection are intended to protect the device against overload conditions. For normal operation the junction temperatures should not exceed 125°C.

The input of the device will withstand reverse voltages of 15V. Current flow into the device will be limited to less than 1mA (typically less than 100μA) and no negative voltage will appear at the output. The device will protect both itself and the load.

The SENSE pin is internally clamped to one diode drop below ground. If the SENSE pin is pulled below ground, with the input open or grounded, current must be limited to less than 5mA.

Several different input/output conditions can occur in regulator circuits. The output voltage may be held up while the input is either pulled to ground, pulled to some intermediate voltage or is left open circuit. Current flow back into the output will vary depending on the conditions. Many circuits incorporate some form of power management. The following information summarized in Table 2 will help optimize power usage.

**Table 2. Fault Conditions**

INPUT PIN	SHDN PIN	OUTPUT/SENSE PINS	RESULTING CONDITIONS
< V <sub>OUT</sub> (Nominal)	Open (High)	Forced to V <sub>OUT</sub> (Nominal)	Reverse Output Current ≈ 150μA (See Figure 3) Input Current ≈ 1μA (See Figure 4)
< V <sub>OUT</sub> (Nominal)	Grounded	Forced to V <sub>OUT</sub> (Nominal)	Reverse Output Current ≈ 150μA (See Figure 3) Input Current ≈ 1μA (See Figure 4)
Open	Open (High)	> 1V	Reverse Output Current ≈ 150μA (See Figure 3)
Open	Grounded	> 1V	Reverse Output Current ≈ 150μA (See Figure 3)
≤ 0.8V	Open (High)	≤ 0V	Output Current = 0
≤ 0.8V	Grounded	≤ 0V	Output Current = 0
> 1.5V	Open (High)	≤ 0V	Output Current = Short-Circuit Current
-15V < V <sub>IN</sub> < 15V	Grounded	≤ 0V	Output Current = 0

## APPLICATIONS INFORMATION

The reverse output current will follow the curve in Figure 3 when the input is pulled to ground. This current flows through the OUTPUT pin to ground. The state of the SHDN pin will have no effect on output current when the input pin is pulled to ground.

In some applications it may be necessary to leave the input on the LT1528 unconnected when the output is held high. This can happen when the LT1528 is powered from a rectified AC source. If the AC source is removed, then the input of the LT1528 is effectively left floating. The reverse output current also follows the curve in Figure 3 if the input pin is left open. The state of the SHDN pin will have no effect on the reverse output current when the input pin is floating.

When the input of the LT1528 is forced to a voltage below its nominal output voltage and its output is held high, the output current will follow the curve shown in Figure 3. This can happen if the input of the LT1528 is connected to a low voltage and the output is held up by a second regulator circuit. When the input pin is forced below the Output pin or the OUTPUT pin is pulled above the input pin, the input current will typically drop to less than  $2\mu\text{A}$  (see Figure 4). The state of the SHDN pin will have no effect on the reverse output current when the output is pulled above the input.

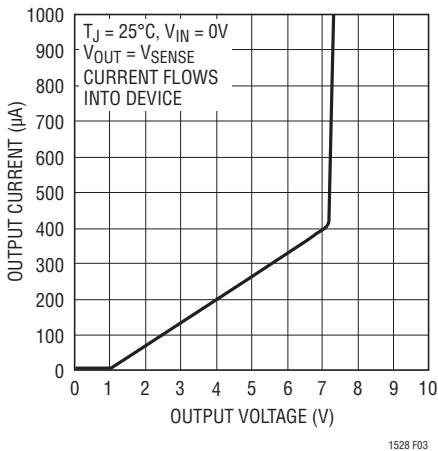

Figure 3. Reverse Output Current

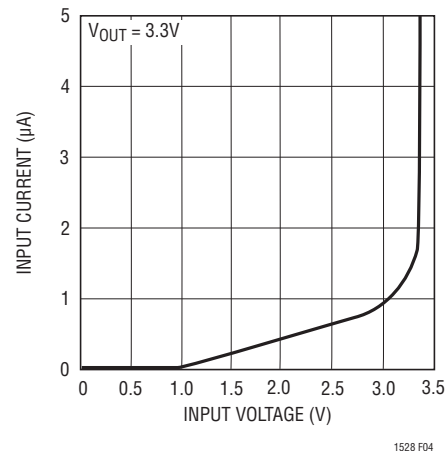
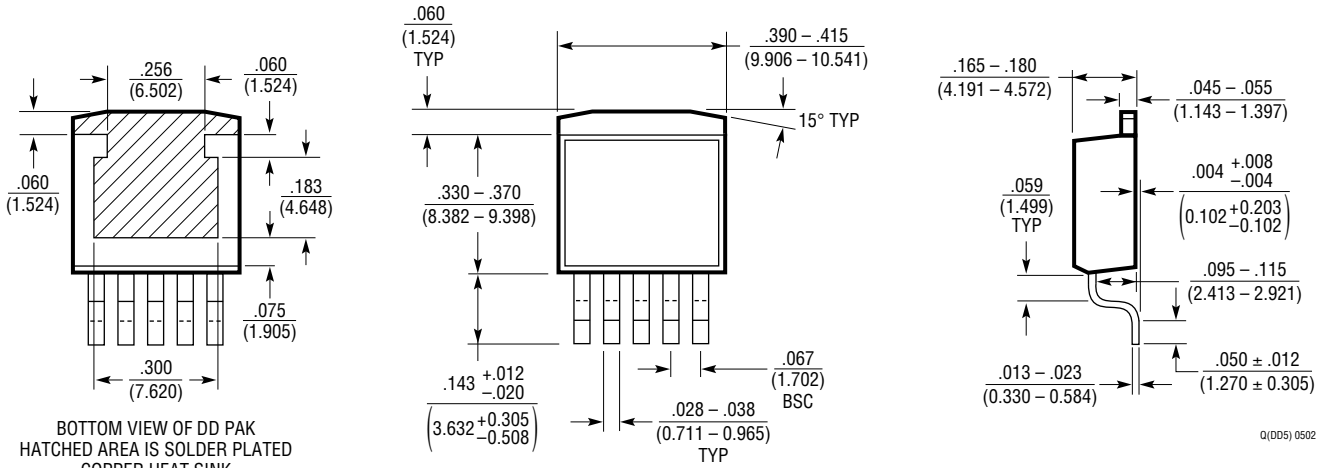

Figure 4. Input Current

**PACKAGE DESCRIPTION**

**Q Package**  
**5-Lead Plastic DD Pak**  
 (Reference LTC DWG # 05-08-1461)



Q(005) 0502

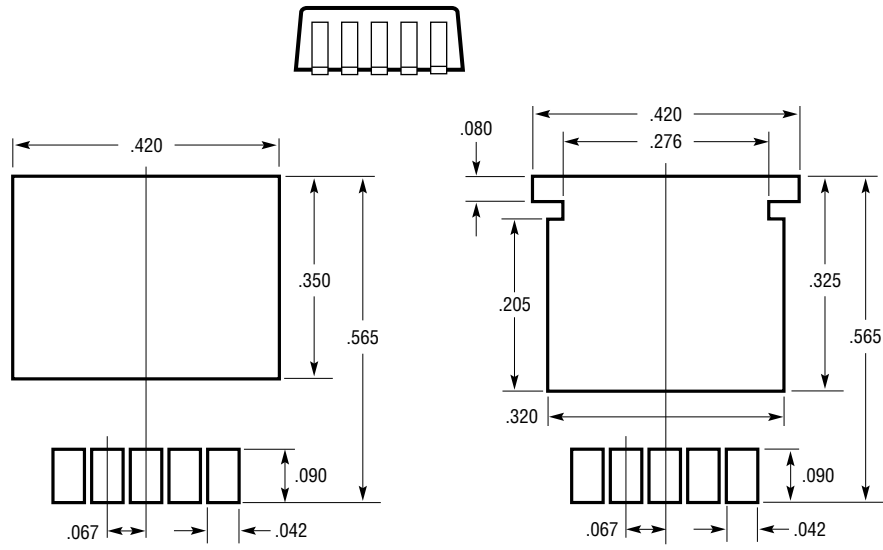

RECOMMENDED SOLDER PAD LAYOUT  
 NOTE:  
 1. DIMENSIONS IN INCH/(MILLIMETER)  
 2. DRAWING NOT TO SCALE

RECOMMENDED SOLDER PAD LAYOUT  
 FOR THICKER SOLDER PASTE APPLICATIONS

**PACKAGE DESCRIPTION**

**T Package**  
**5-Lead Plastic TO-220 (Standard)**  
 (Reference LTC DWG # 05-08-1421)

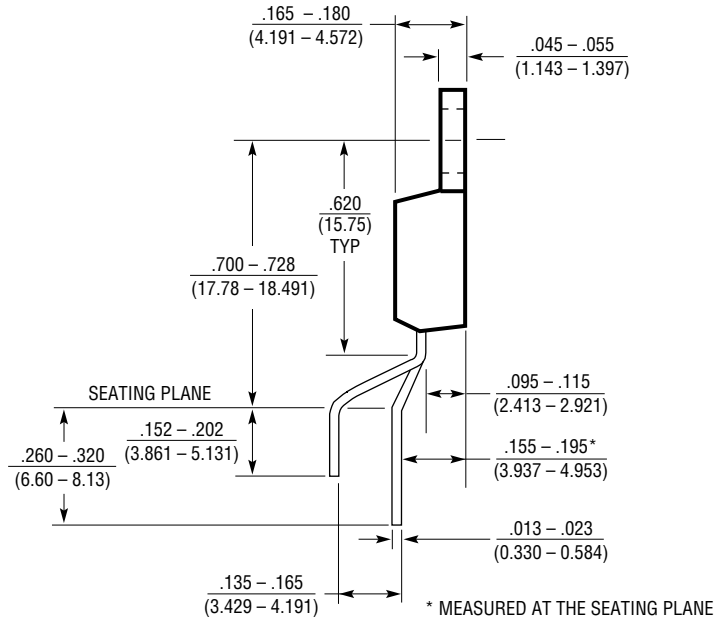
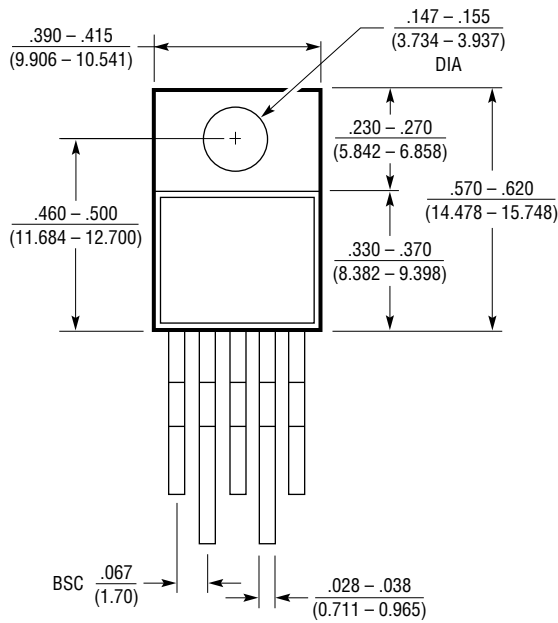

**RELATED PARTS**

PART NUMBER	DESCRIPTION	COMMENTS
LTC®1265	High Efficiency Step-Down Switching Regulator	>90% Efficient 1A, 5V to 3.3V Conversion
LTC1266	Synchronous Switching Controller	>90% Efficient High Current Microprocessor Supply
LT1521	300mA Micropower Low Dropout Regulator	15µA Quiescent Current
LT1584	7A Low Dropout Fast Transient Response Regulator	For High Performance Microprocessors
LT1585	4.6A Low Dropout Fast Transient Response Regulator	For High Performance Microprocessors