



E-PLASTICASE®

FR // L'ÉCRIN DE VOTRE COMMUNICATION

GB // FOR THE ULTIMATE PRESENTATION

DE // IHRE VISITENKARTE ERSTKLASSIGER PRODUKTE



MADE
IN
FRANCE

GAGGIONE

VALISETTES / MINI-CASES / KOFFERCHEN



- FR // Poignées sortantes, semi-intégrées - Polypropylène copolymère, grainage fin.
 GB // Semi-integral pull-out handles - Copolymer polypropylene, fine textured.
 DE // Herausstehende halbintegrierte Griffe - Copolymer Polypropylen, feingekörnt.

Modèle / Model / Modell
G 1 - R 2 - R 3 - R 4 - D 4 - D 1 - D 2

CONFORT / COMFORTABLE / KOMFORT-VERPACKUNGEN

- FR // Poignées sortantes, mobiles - Polypropylène copolymère.
 GB // Moving handle - Copolymer polypropylene.
 DE // Herausstehende bewegliche Griffe - Copolymer Polypropylen.

Modèle / Model / Modell
M 1 - M 2



ÉTUIS / CASES / KÄSTCHEN

- FR // Sans poignée. **P 3** : Fermeture/ouverture originale.
 GB // No handle. **P 3** : Original design opening/closing device.
 DE // Ohne Griff. **P 3** : Origineller Verschuß.



Modèle / Model / Modell
P 3 - P 5

COMPACT / COMPACT / KOMPAKT

FR // Poignées intégrées - Polypropylène copolymère.

R 1 - L 1 : Pans coupés - **B 2** : Empilable

GB // Integral handles - Copolymer polypropylene

R 1 - L 1: Bevelled - **B 2**: Stackable

DE // Integrierte Griffe - Copolymer Polypropylen

R 1 - L 1: Abgeschrägt - **B 2**: Stapelbar

Model / Modèle / Modell

R 1 - L 1 - S 1 - C 1 - A 1 - B 1 - B 2



ÉVOLUTION / EVOLUTION / ENTWICKLUNG

FR // Grands volumes, fermoirs de couleurs (voir page 7) - Polypropylène copolymère.

T 7 : Possibilité de verrouillage, empilable.

GB // Large capacity, coloured fasteners (see page 7) - Copolymer polypropylene.

T 7: Easy to lock and stackable.

DE // Große Kapazitäten, farbige Verschlüsse (siehe Seite Nr. 7) - Copolymer Polypropylen.

T 7: Verschließbar und stapelbar.

Modèle / Model / Modell

T 2 - T 4 - T 7

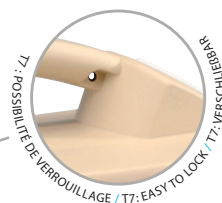

FERMOIRS DE COULEURS / COLOURED FASTENERS / FARBIGE VERSCHLÜSSE



SUPPORT MURAL / WALL BRACKET / WANDTRÄGER

FR // **100 % pratique**. Gain de place, gain de temps, toujours prêt pour les urgences.

GB // **100% practical**. Saves space and time, always ready for emergencies.

DE // **100% ig praktisch**. Platzersparnis, Zeitgewinn, immer für dringende Angelegenheiten bereit.

Modèle / Model / Modell

RA - RB - LA

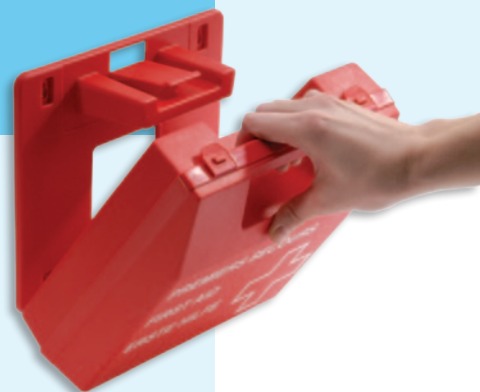

CRISTAL / CRISTALLINE / KRISTALL

FR // Les épaisseurs des parois produisent des effets de lumière qui rendent ces écrans luxueux, proposés à un prix attractif, avec la haute qualité de finition signée GAGGIONE.

CR 700 - CR 800 - CR 1800 - CR 3500 : Résine acrylique PMMA.

G 2 : PMMA "choc" - **G 3** : PS

GB // A luxury box at a realistic price. The light catching qualities and the high quality finish says GAGGIONE.

CR 700 - CR 800 - CR 1800 - CR 3500: PMMA acrylic resin.

G 2 : "Choc" PMMA - **G 3**: PS

DE // Die Wanddicke des Etuis bewirkt Lichteffekte, welche der luxuriösen Ausführung durch bei GAGGIONE sehr günstigen Preisen gerecht wird.

CR 700 - CR 800 - CR 1800 - CR 3500: Akryl-Harz PMMA.

G 2: PMMA "choc" - **G 3**: PS



CR 3500



CR 1800



CR 800



G 2 / G 3



CR 700



Modèle / Model / Modell

CR 700 - CR 800 - CR 1800 - CR 3500 - G 2

VISION / VISIBILITY / VISION

FR // **G 3** : Polystyrène cristal.

F 1 - A 2 : Résine K + polypropylène. Résistants aux chocs.

G 1 T - R 2 T - R 2 C - T 2 T - R 3 T - T 4 T - D 1 T : Polypropylène transparent.

GB // **G 3**: Crystal polystyrene.

F 1 - A 2: K resin + polypropylene. Shock resistant materials.

G 1 T - R 2 T - R 2 C - T 2 T - R 3 T - T 4 T - D 1 T: Transparent polypropylene.

DE // **G 3**: Kristallklares Polystyrol.

F 1 - A 2: K-Harz + Polypropylen. Widerstandsfähiges Material.

G 1 T - R 2 T - R 2 C - T 2 T - R 3 T - T 4 T - D 1 T: durchsichtiges Polypropylen.



T4 T

T2 T

Modèle / Model / Modell

G 3 - G 1 T - R 2 T - R 2 C - R 3 T - F 1 - T 2 T - A 2 - T 4 T - D 1 T



A 2

D1 T

F 1

R3 T

R2 C

G 3

G1 T

R2 T



FERMOIRS DE COULEURS / COLOURED FASTENERS / FARBIGE VERSCHLÜSSE

FR // **Composez votre modèle**
GB // **Personalize your product**
DE // **Stellen Sie Ihr Produkt zusammen**

e-plasticase.com



FR // Sérigraphie / Aménagement intérieur Mousse / Thermoformage...
GB // Silk-screen printing / Foam Insert / Vacuum-formed Insert...
DE // Siedbruck / Innenausführung aus Schaumstoff / Tiefziehteil...

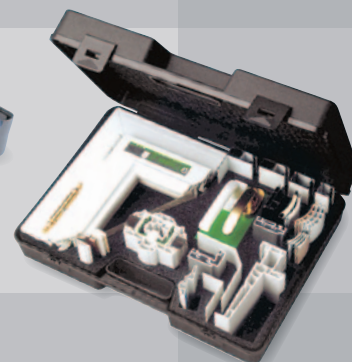

Dès 500 pièces / Minimum 500 parts / Ab 500 Stück

FR // En plus de tous les coloris standards (pages 6 et 7), vous disposez d'un choix complémentaire en coloris opaques ou translucides.
GB // As well as all the standard colours (pages 6 and 7), you have an additional choice of opaque or translucent colours.
DE // Zusätzlich zu allen Standardfarben (auf den Seiten 6 und 7), verfügen Sie ebenfalls über eine Auswahl von undurchsichtigen und durchsichtigen Farben.

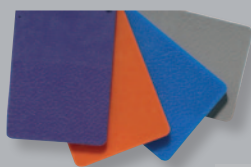

Sur-mesure / Made to measure / Auf Mass

FR // Coloris, dimensions, coffrets spéciaux, aménagements..., de l'étude à la fabrication, nous répondons à vos demandes spécifiques.
GB // Colours, dimensions, special boxes, inserts..., from design to manufacture, we offer a response to your specific requirements.
DE // Farben, Abmessungen, Sonderkästchen, Einlagen..., vor der Studie bis zur Herstellung, Wir stehen für spezifische Anforderungen zu Ihrer Verfügung.



CR700



CR800

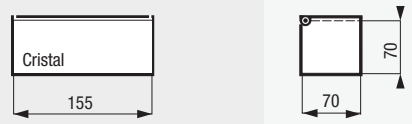

CR1800



CR3500

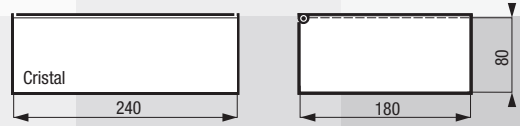

P3

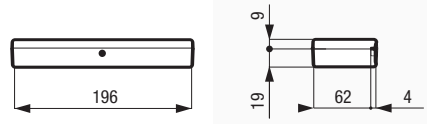

P5

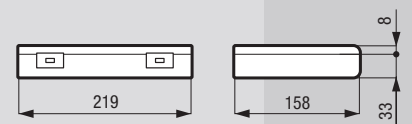

G1

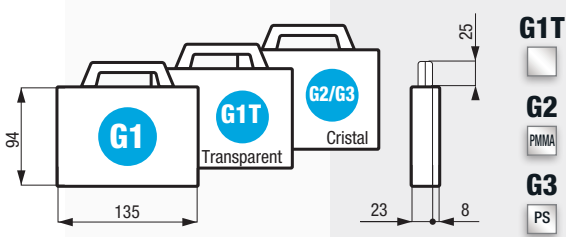

G1T



M2

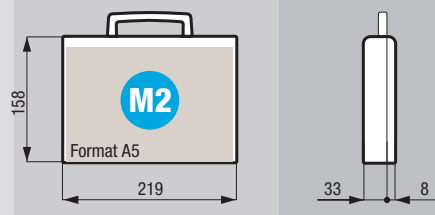

R2

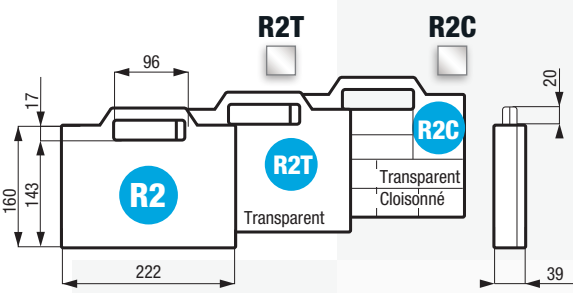

R1

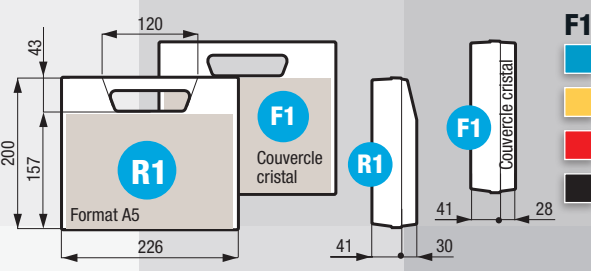

F1



Combinaison en stock / On stock / Am Lager

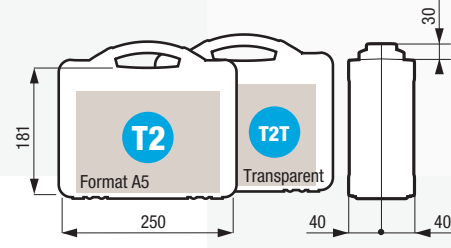
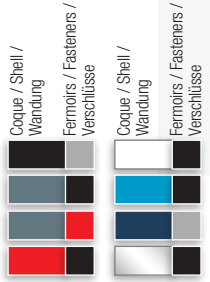

Autres coloris de fermoirs / Fasten. / Verschl. Blue, Yellow, Red, Grey, Green, White, Black

R3

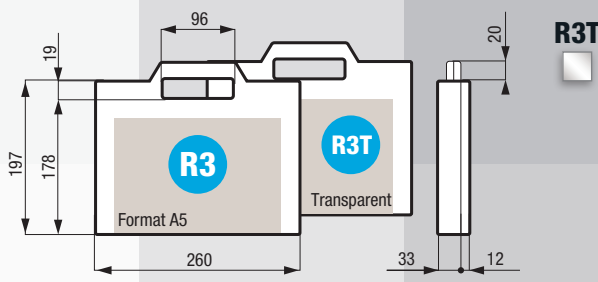

R3T

R4

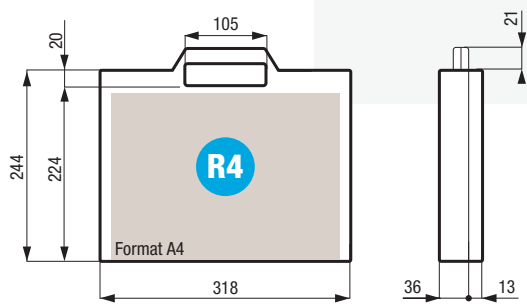

D4

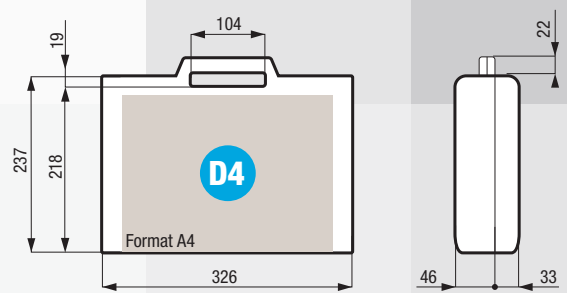

M1

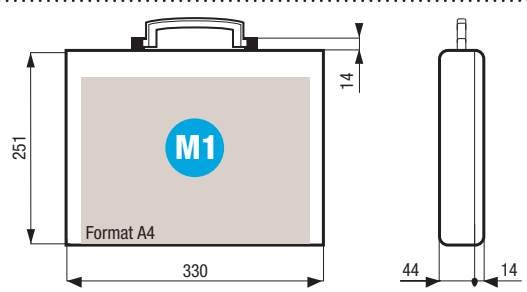

S1

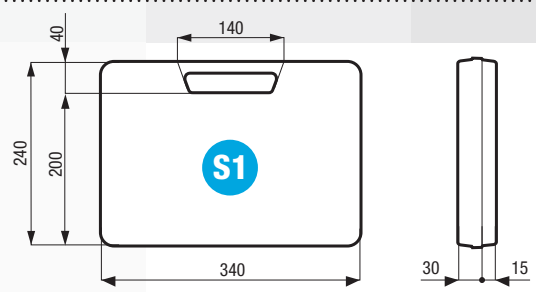

FR // Dimensions utiles en mm.
 GB // Useful dimensions in mm.
 DE // Nützliche Abmessungen in mm.

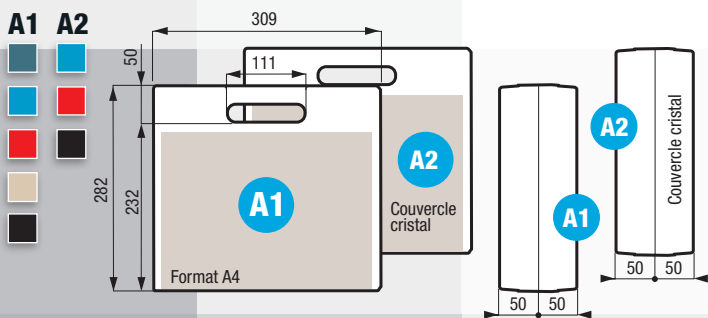
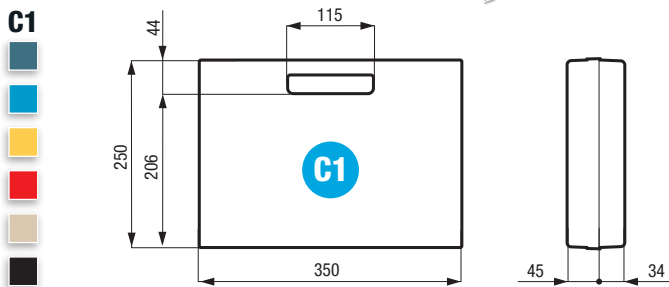
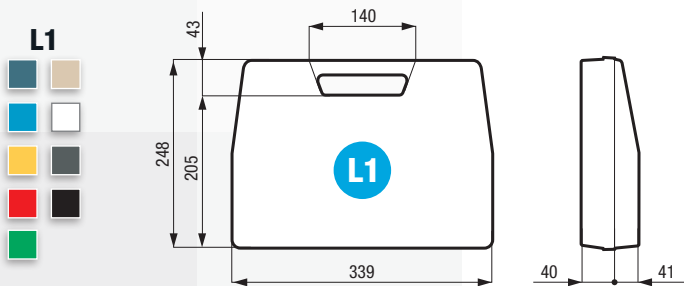

Combinaison en stock / On stock / Am Lager

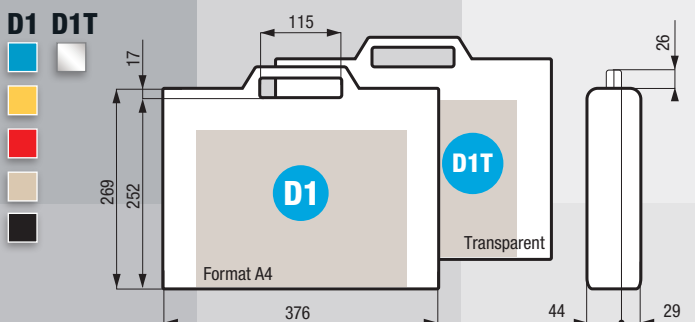
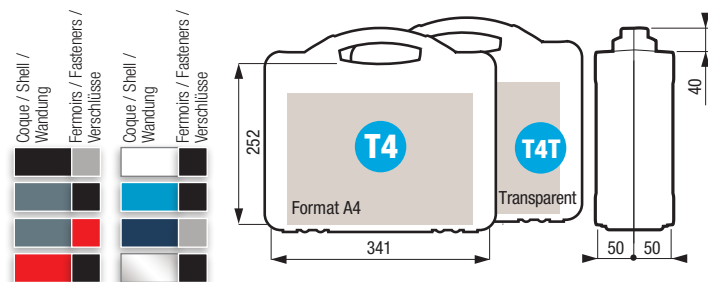

Autres coloris de fermoirs / Fasten. / Verschl.

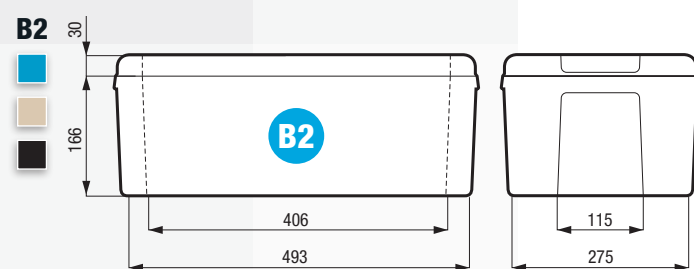
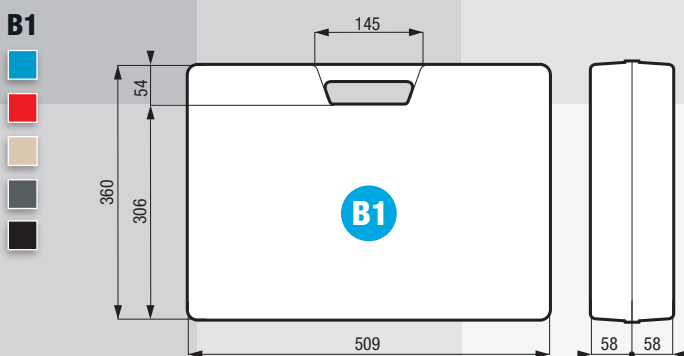
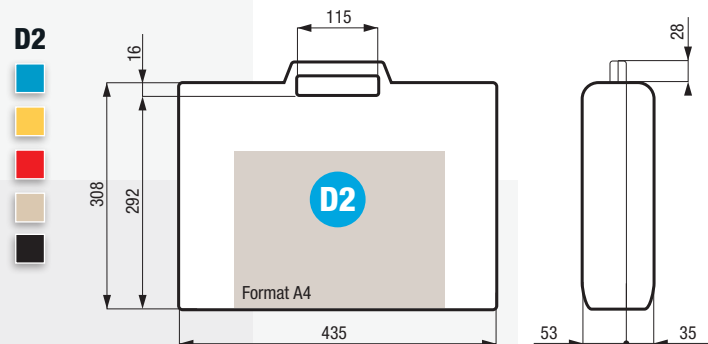

Combinaison en stock / On stock / Am Lager

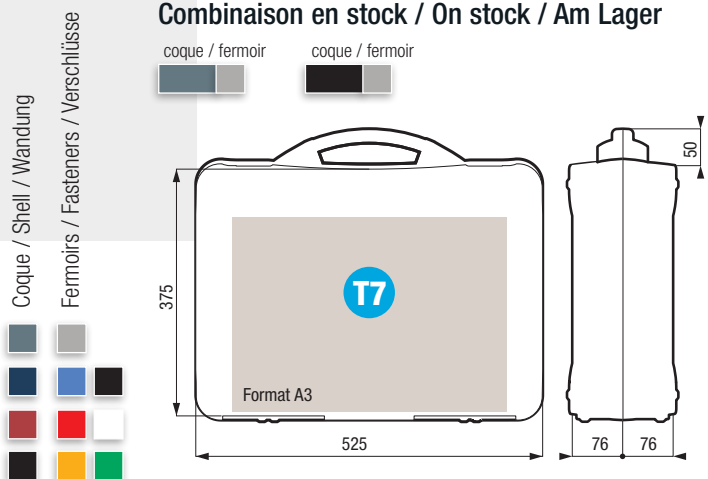

SUPPORT MURAL
WALL BRACKET
WANDTRÄGER

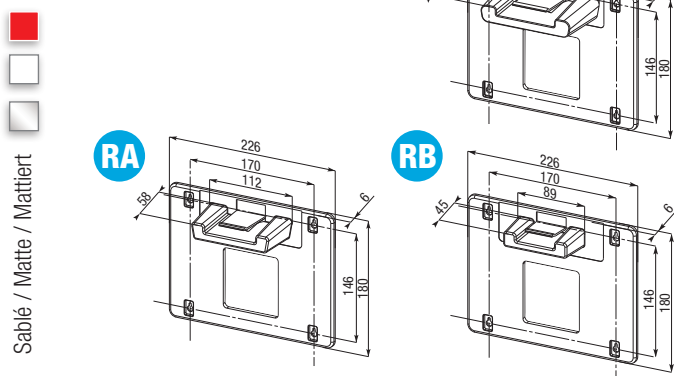

E-PLASTICASE®

FR // QUALITÉ / FIABILITÉ - DÉVELOPPEMENT DURABLE

- Notre certification ISO 9001.
- Le choix d'une matière de base de haute qualité, le polypropylène copolymère.
- Un concept de charnière éprouvé en laboratoire.

UK // Quality / Reliability - Sustainable development

- Our ISO 9001 certification.
- The choice of a high quality base material, the Copolymer Polypropylene.
- Hinges tested in Laboratory.

DE // Qualität / Nachhaltige Entwicklung

- Unsere Zertifizierung nach ISO 9001.
- Die Wahl eines hochwertigen Materials, Kopolymer Polypropylen.
- Die Scharniere wurden im Labor erprobt.

www.e-plasticase.com

FR // En 3 clics, composez et visualisez le(s) modèle(s) de votre choix.

Accédez aux fiches techniques des produits.

Demandez un devis et recevez-le sous 48h. Découvrez notre actualité.

GB // In 3 clicks, create and view your own selection of case(s).

Get to products' technical data.

Ask for a quotation and get an answer within 48 hours. Discover our News.

DE // Mit 3 Klicks wird Ihr gewähltes Modell entworfen, zusammengestellt und gesichtet

Gehen Sie auf Produkte, technische Daten. Fragen Sie nach einem Kostenvoranschlag.

Sie erhalten Antwort innerhalb 48 Stunden. Entdecken Sie unsere Neuheiten.

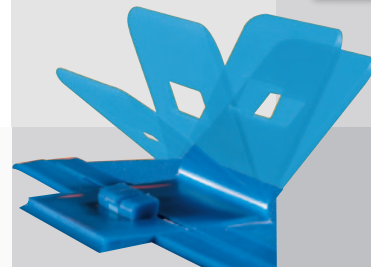
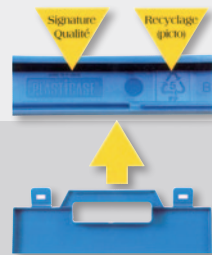

100 000

MANŒUVRES
FLEXINGS
BIEGUNGEN

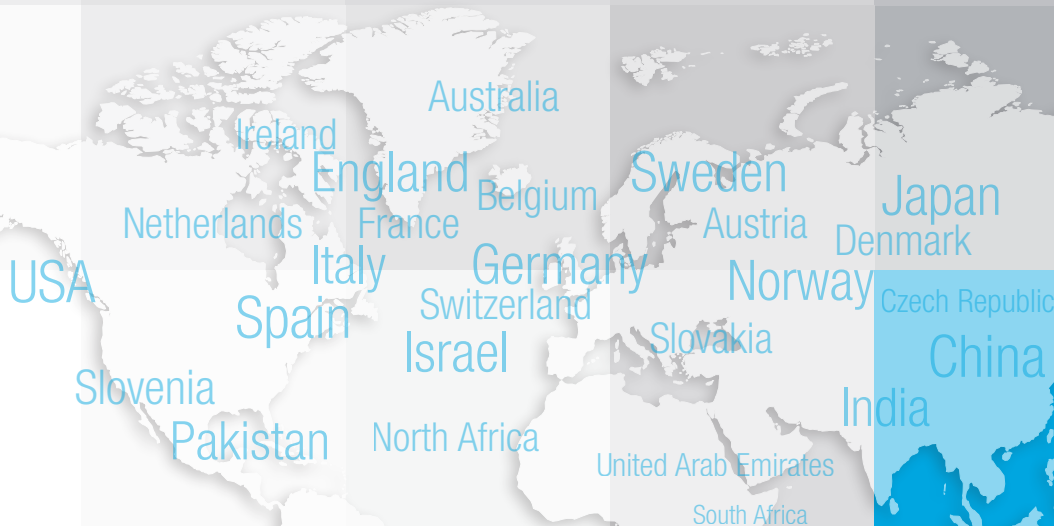

ALCATEL • AIR LIQUIDE • BENETEAU • BARDAHL • BAYER • BHV • BLACK & DECKER • BREITLING • BOSCH • BOORWERK • BOEHRINGER • BROWNING • CAMPING GAZ • PIERRE CARDIN
CHARMILLES TECHNOLOGIES • CEMBRE • COLLY COMPANY • LE CREUSET • DANFOSS • DASSAULT • DISETRONIC • ENRAF • NONIUS • ESSLOR • EURO RSCG • FACOM • FENWICK
GENERAL ELECTRIC MEDICAL SYSTEM • GILLETTE • GCE • GALERIES LAFAYETTE • HEWLETT PACKARD • HILTI • IBM • IMAJE • JOOP • KODAK • KURZ • LEGRAND • MERCEDES • MICHELIN • MITCHELL
MIGROS • MITSUBISHI • MOBALPA • MUJI • 3 M • NIVEA BEIERSDORF • NGK • NORSONIC • NOVO NORDISK • ORLANE • L'OREAL • OTALU • ORKYN' • PARKER HANNIFIN • PHILIPS • PFIZER • POLAR
RAJA • RADIOMETER ANALYTICAL • RENAULT • REVLON • RHONE MERIEUX • ROTRING • SAGEM • SANDOZ • SANOFI • SENNHEISER • SCHLUMBERGER • SCHNEIDER • SERONO • SMITHKLINE BEECHAM
SONY PLAZA • ST DUPONT • STAEDTLER • STANLEY • STIHL • TAILLEUR INDUSTRIE • TESA • TEXAS INSTRUMENTS • THOMSON • TOSHIBA • TOTAL • UNICEF • URGO • USAG • VALÉO • WURTH
WYNN'S • YVES ROCHER • ZODIAC...

GAGGIONE S.A.S.

3 rue de la Rolland _ B.P. 29

01460 MONTRÉAL LA CLUSE _ FRANCE

Tél. 33 (0)4 74 76 12 66 _ Fax 33 (0)4 74 76 73 73

plasticase@gaggione.com _ www.e-plasticase.com