



Datasheet

RS PRO SA Series, Aluminum

Stock number: 188-1341

EN



Our SA Series of stand along general use electronic enclosures is highly versatile line of quality enclosures for both industrial and hobby use. The rugged steel body provides easy access to the components being assembled inside. The Aluminum front and rear panels are ideal for end user customization. Available in 24 different sizes and configurations, the SA Series enclosures come flat packed and its unique "snap together" design requires only 4 screws to complete the assembly.

Features

- Light weight and strong
- Very durable all aluminum (AL 5052) construction
- Easy to assemble, only 4 screws needed
- Extensive top/bottom and side/side ventilation
- Two pieces of extruded aluminum component mounting bars for components fixing are included in the basic kit. Additional bars may be ordered as needed.
- Flat pack for efficient storage and shipping

Standards and Materials

- Heights from 1.5U to 5U, conform to IEC-60297-1.
- Widths of 230mm, 305mm and 432mm
- Depths of 178mm and 279mm
- Premium grade (AL 5052) aluminum.
- Designed and manufactured under ISO 9001:2008 and ISO 14001:2004
- All materials RoHS compliant.

2U - 5U Size

Packing List:

Item no.	Part Name	Quantity
1.	Front Rear Panel	2 pieces
2.	Side Frame	2 pieces
3.	General Purpose Bar	2 pieces
4.	Umbrella Phillips Screw M3-6	4 pieces
5.	Top/Bottom Cover	2 pieces
6.	Umbrella Phillips Dog Point Screw M4-8	4 pieces
7.	Rubber Feet	4 pieces

Exploded view of parts and hardware List:

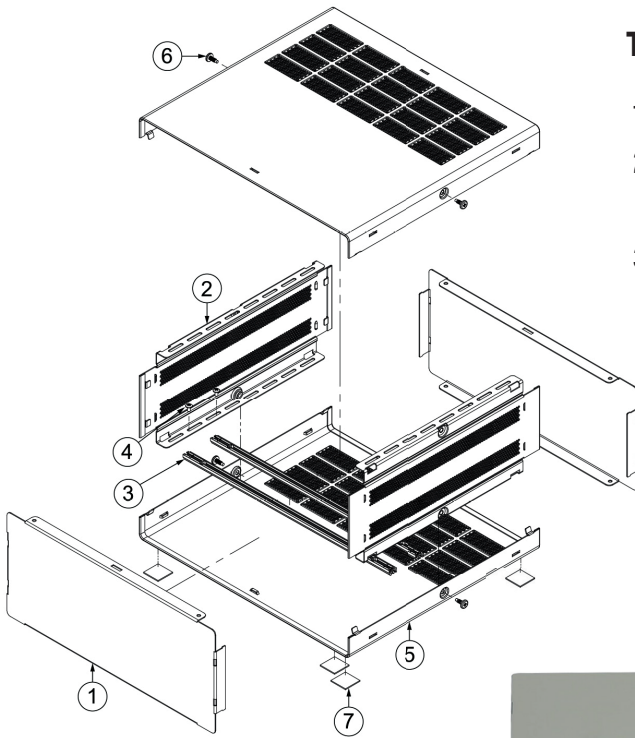

Tools needed:

1. Phillips screwdriver.
2. Utility blade for unpacking and cutting plastic bags.
3. Assembly table with soft pad on top to prevent scratch.



rew M3x6



Screw M4x8

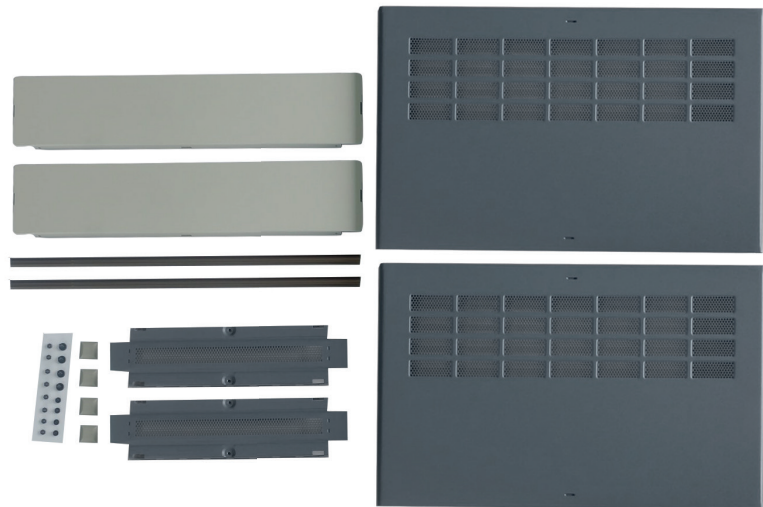

Assembly Procedure:

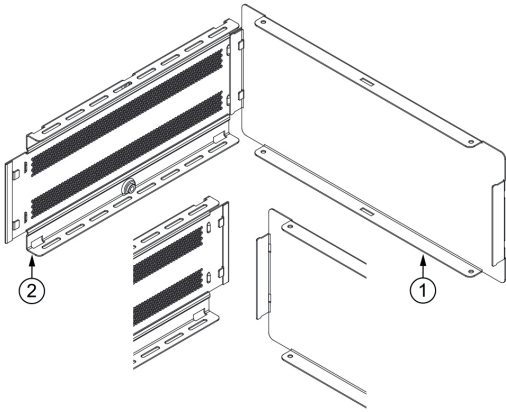

1. Assemble Side Frame to Front Rear Panel.

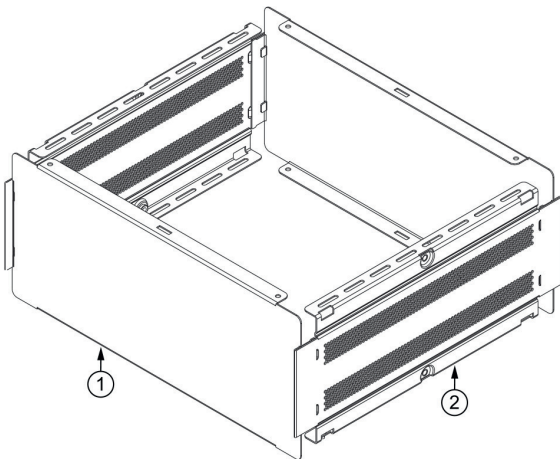

2. Complete Side Frames and Front Rear Panel assembled.

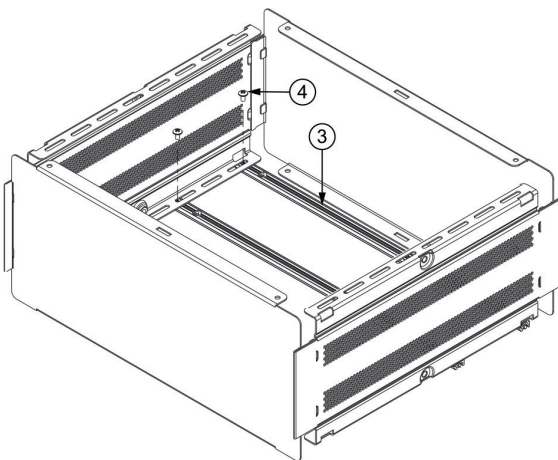

3. Component Mounting Bar assemble use Nut M3 and Screw M3x6

* User defines location of General Purpose Bar

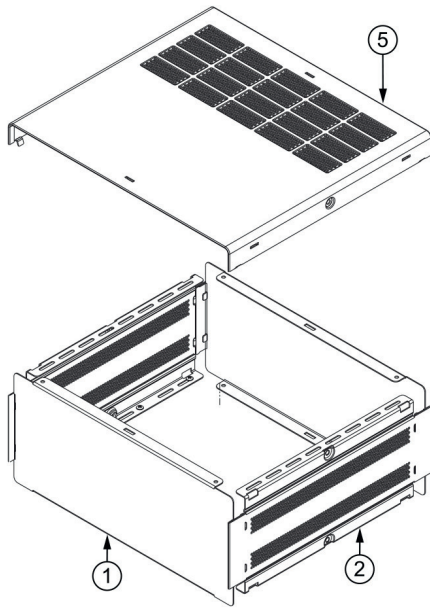

4. Assemble Top Cover

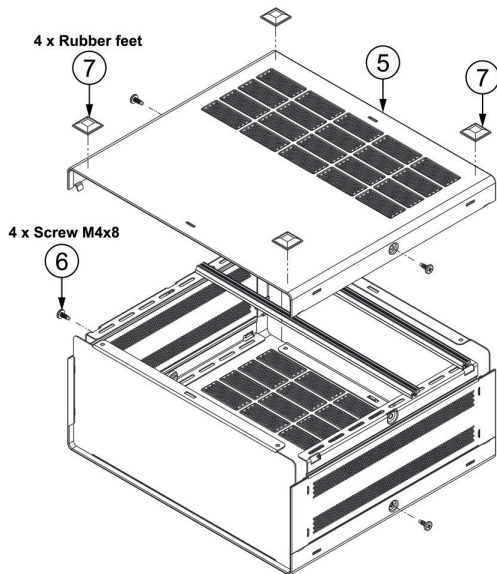

5. Assemble Bottom Cover and Rubber Feet

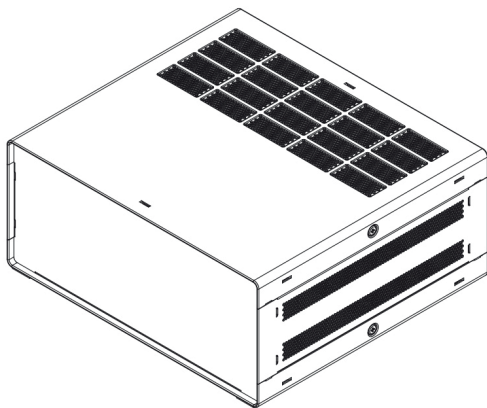

6. Finished assembly

Specifications

Attribute	Value
Product 188-1341	SA Series 5.0-432W-279D
External Width	432mm
External Depth	279mm
External Height	219mm
External Dimensions	432 x 279 x 219
Body Material	Aluminum Extrusion
IP Rating	IP30
Color	Light Gray Texture
Lid Color	Blue Texture
Flanged	No
Shielded	No
Gasket Material	No
Standard Met	ROHs Compliant
Application	Electrical, Electronic, Industrial