

General Description

Evaluation kit DC2851A is a quad-channel synchronous step-down regulator featuring the [LT7200S](#). The LT7200S is ideal for high step-down ratio applications that operate at high frequency while demanding fast transient response thanks to its constant frequency, current-mode architecture, and phase-lockable controlled on-time. The DC2851A operates from an input voltage range of 2.9V to 18V, with each regulator capable of delivering $\pm 5A$ of output current. The evaluation kit is designed for 1.2V, 1.8V, 3.3V, and 5V outputs with switching frequency set at 1MHz. The DC2851A provides LT7200S-based different multichannel combinations for flexible output current rating.

The LT7200S features independent soft-start, output tracking and power good for each output to simplify the complex design of quad-output converters. The output tracking and soft-start pins allows to control the rise time and ramp rate of the output voltage. Each output can be independently disabled into the low quiescent current shutdown mode with its own TRACK or RUN pin.

A user-selectable MODE/SYNC pin on the evaluation kit allows the part to operate in either discontinuous mode for higher efficiency at light load currents, or forced continuous mode for lower output ripple at the expense of

light load efficiency. The MODE/SYNC pin can also be used to synchronize the switching frequency to an external clock. The switching frequency for all regulators can be programmed either through the oscillator resistor or external clock over a 400kHz to 3MHz range. At all frequencies, a 180° phase shift is maintained between channel 1 and channel 2, channel 3 and channel 4 when PHMODE pin is low, reducing the input peak current and voltage ripple.

The DC2851A has an EMI filter installed on the bottom layer. The conducted and radiated EMI performance of the board is shown in Figure 4. The red line in Figure 4 is the CISPR25 Class 5 peak limit. The figure shows that the circuit passes the test with a wide margin. To achieve EMI/ EMC performance as shown in Figure 4, the input EMI filter is required, and the input voltage should be applied at VEMI turret.

The LT7200S data sheet gives a complete description of the part operation and application information. Read the data sheet in conjunction with this quick start guide for DC2851A. The LT7200S is assembled in a 5mm \times 6mm LQFN package with exposed pads for low thermal resistance. Proper board layout is essential for both low EMI operation and best thermal performance.

Performance Summary Specifications are at $T_A = 25^\circ\text{C}$

SYMBOL	PARAMETER	CONDITIONS	MIN	TYP	MAX	UNITS
$V_{IN1}, V_{IN2}, V_{IN3}, V_{IN4}$	Input Voltage Range		2.9	12	18	V
V_{OUT1}	Default Output Voltage	$V_{IN} = 12\text{V}, I_{OUT} = 0\text{A to } 5\text{A per Channel}$	1.15	1.2	1.25	V
V_{OUT2}	Default Output Voltage	$V_{IN} = 12\text{V}, I_{OUT} = 0\text{A to } 5\text{A per Channel}$	1.73	1.8	1.87	V
V_{OUT3}	Default Output Voltage	$V_{IN} = 12\text{V}, I_{OUT} = 0\text{A to } 5\text{A per Channel}$	3.17	3.3	3.43	V
V_{OUT4}	Default Output Voltage	$V_{IN} = 12\text{V}, I_{OUT} = 0\text{A to } 5\text{A per Channel}$	4.8	5	5.2	V
$I_{OUT1}, I_{OUT2}, I_{OUT2}, I_{OUT4}$	Maximum Continuous Output Current per Channel	$V_{IN} = 12\text{V}$	5			A
f_{sw}	Switching Frequency		0.9	1	1.1	MHz
E_{ff}	Efficiency	$V_{IN} = 12\text{V}, f_{sw} = 1\text{MHz}, V_{OUT1} = 1.2\text{V}, V_{OUT2} = 1.8\text{V}, V_{OUT3} = 3.3\text{V}, V_{OUT4} = 5\text{V}, I_{OUT1} = I_{OUT2} = I_{OUT3} = I_{OUT4} = 5\text{A}$		90		%

Quick Start Procedure

The evaluation kit DC2851A is easy to set up to evaluate the performance of the LT7200S. See Figure 1 for proper measurement equipment setup and follow this procedure.

1. With power off, place the jumpers in the following positions:

JP1	JP2	JP3	JP4	JP5	JP6
RUN1	RUN2	RUN3	RUN4	MODE/ SYNC	PHMODE
ON	ON	ON	ON	FCM	LOW

2. With power off, connect the input power supply to VEMI+ and VEMI-.
3. With power off, connect the loads from VOUT1, VOUT2, VOUT3, and VOUT4 to GND.
4. Place the voltmeters across the output terminals to get accurate output voltage measurements.
5. Turn on the power at the input.

NOTE: Make sure that the input voltage does not exceed 18V and $V_{IN} > V_{OUT}$.

6. Check for proper output voltages. Regulate the output at 1.2V (±4%), 1.8V (±4%), 3.3V (±4%), and 5.0V (±4%).

NOTE: If there is no output, temporarily disconnect the load to make sure the load is not set too high.

7. Once the proper output voltage is established, adjust the load within the operating ranges and observe the output voltage regulation, ripple voltage, efficiency, and other parameters.

NOTE: When measuring the input or output voltage ripple, take care to avoid a long ground lead on the oscilloscope probe. Measure the output voltage ripple by

touching the probe tip directly across the output capacitor. See Figure 2 for the proper scope technique.

8. Add an external clock to the SYNC terminal when SYNC function is used (JP5 on the CLKIN position). Make sure to choose the R50 resistor to set the LT7200S switching frequency close to the synchronization frequency.

9. (Option) 4-Phase 20A Output Circuit Configuration:

DC2851A can be configured as a 4-Phase 20A output regulator.

The following simple modifications are required:

1. Tie VIN1, VIN2, VIN3, and VIN4 together with 0Ω resistors (R29, R30, R31).
2. Tie RUN1, RUN2, RUN3, and RUN4 together with 0Ω resistors (R33, R34, R48).
3. Tie TRACK1, TRACK2, TRACK3, and TRACK4 together with 0Ω resistors (R58, R59, R60).
4. Tie FB1, FB2, FB3, and FB4 together with 0Ω resistors (R55, R56, and R57). Keep the resistor divider network on one of the 4 channels to program the desired output voltage and remove the resistor divider networks of other 3 channels.
5. Tie ITH1, ITH2, ITH3, and ITH4 together with 0Ω resistors (R62, R63, R64).
6. Tie 4 channel outputs together at the exposed copper strips on the top of the board. Connect the load from VOUT to GND.
7. Calculate and insert the inductors needed for L1, L2, L3, and L4 ($L1=L2=L3=L4$).
8. Place the PHMODE jumper (JP6) to LOW.
9. Place RUN1, RUN2, RUN3, and RUN4 jumpers to ON.

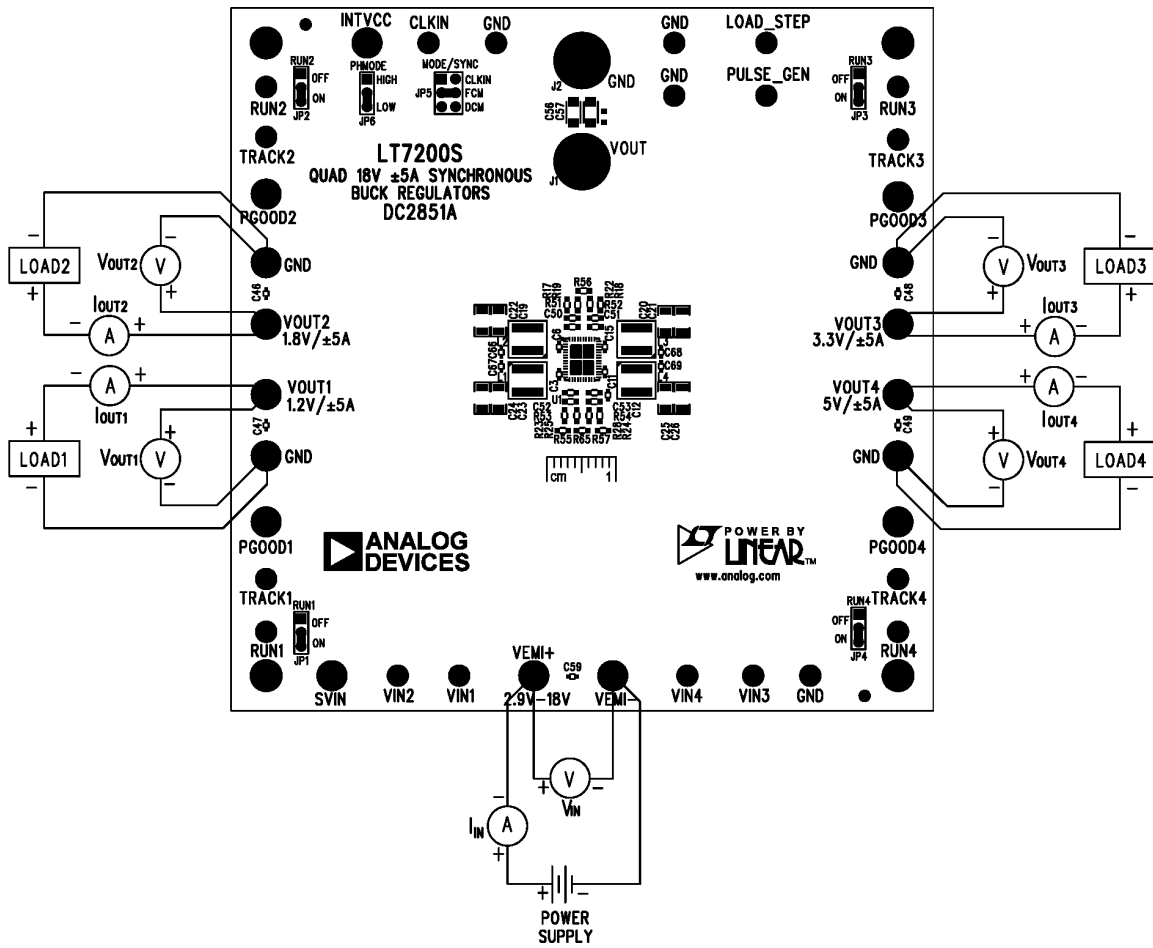

Figure 1. Proper Measurement Equipment Setup

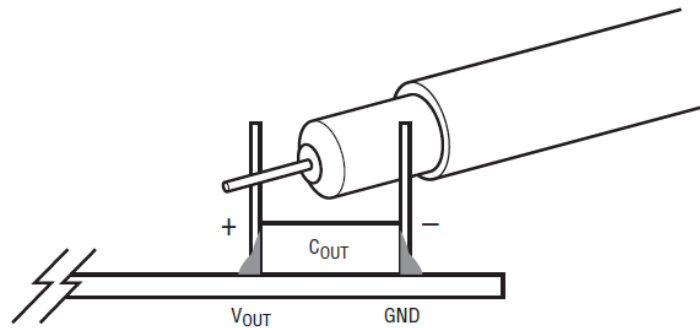

Figure 2. Scope Probe Placement for Measuring Input or Output Voltage Ripple

Typical Performance Characteristics

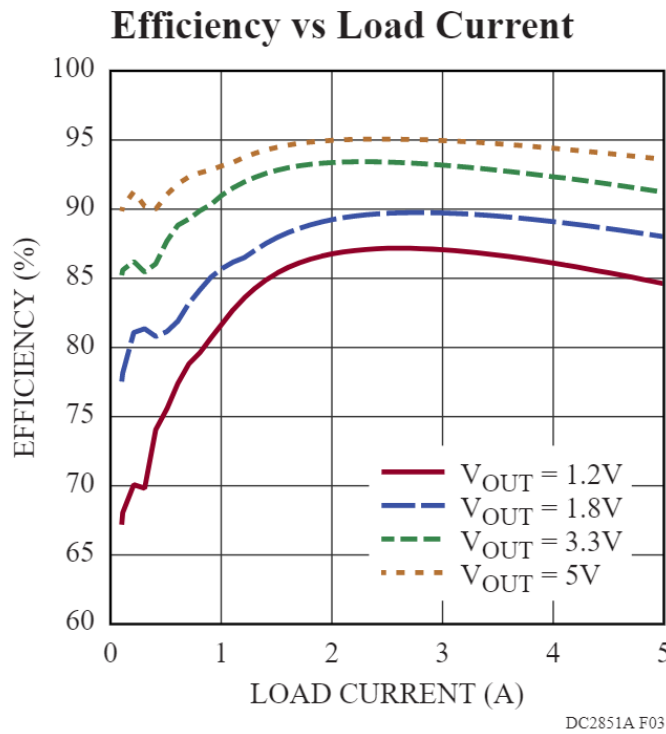
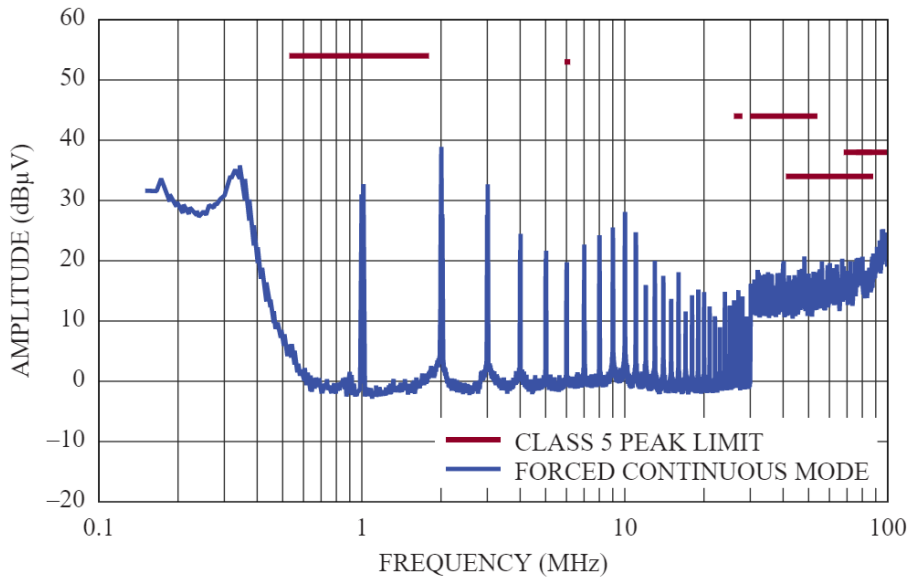

Figure 3. DC2851A Efficiency vs Load Current
 ($V_{IN} = 12V$, 1MHz Switching Frequency, DCM Mode)

Conducted EMI Performance



DC3126A F04a

**Radiated EMI Performance
 Horizontal Polarization**

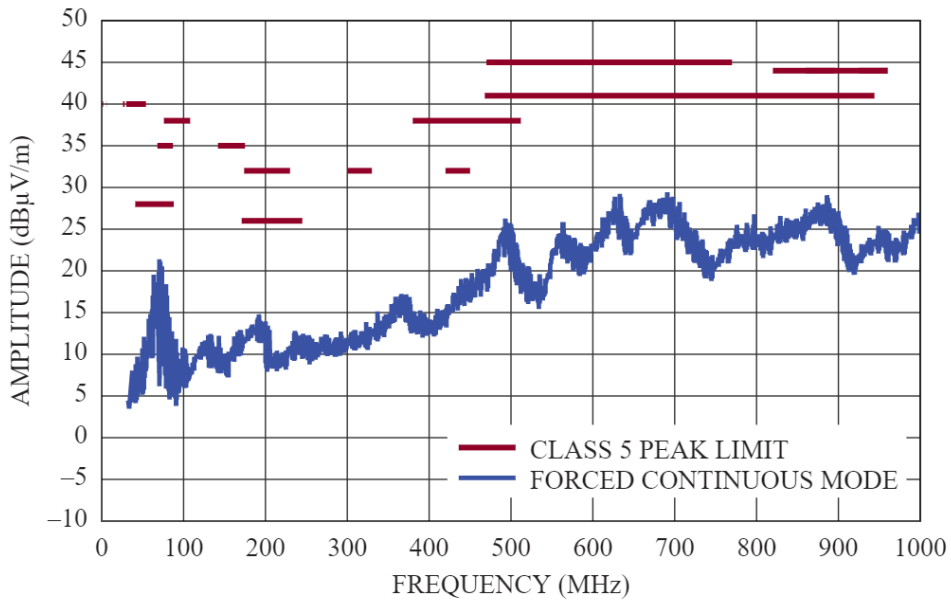

DC2851A F04b

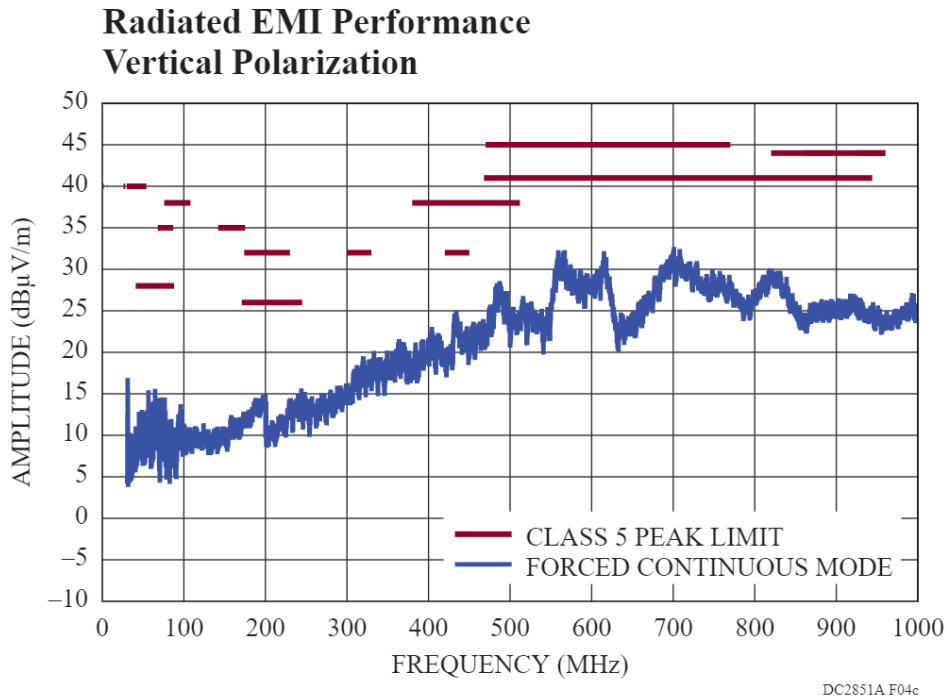

**Figure 4. DC2851A EMI Performance in CISPR25 Conducted and Radiated Emission Tests
 (VEMI = 14V, VOUT1 = 1.2V, VOUT2 = 1.8V, VOUT3 = 3.3V, VOUT4 = 5V,
 IOUT1 = IOUT2 = IOUT3 = IOUT4 = 5A, 1MHz Switching Frequency)**

Bill of Materials

ITEM	QTY	REFERENCE	PART DESCRIPTION	MANUFACTURER/PART NUMBER
Required Evaluation Kit Components				
1	4	C2,C5,C10,C14	CAP.,10uF, X5R,25V,10%,0805	MURATA, GRM21BR61E106KA73L
2	4	C3,C6,C11,C15	CAP.,1uF, X5R,25V,10%,0402	MURATA, GRM155R61E105KA12D
3	1	C12	CAP.,4.7uF, X5R,6.3V,20%,0402	Taiyo Yuden, JMK105BBJ475MVHF
4	1	C16	CAP.,1uF, X5R,25V,10%,0603	AVX, 06033D105KAT2A
5	9	C19,C20,C21,C22,C23, C24,C25,C26,C56	CAP.,47uF, X5R,10V,20%,1206	TDK, C3216X5R1A476M160AB
6	4	C34,C37,C40,C43	CAP.,470pF, X7R,50V,10%, 0603	MURATA, GRM188R71H471KA01D
7	4	C35,C38,C41,C44	CAP.,4.7pF,C0G/NP0,50V,0603	MURATA, GRM1885C1H4R7CA01D
8	4	C36,C39,C42,C45	CAP.,1uF, X5R,10V,10%,0603	TAIYO YUDEN, LMK107BJ105KA-T
9	8	C46,C47,C48,C49,C66, C67,C68,C69	CAP.,4.7uF, X5R,10V,10%,0402	TDK, C1005X5R1A475K050BC
10	4	C50,C51,C52,C53	CAP.,100pF, C0G,50V,5%,0603	TDK, CGA3E2C0G1H101J080AA
11	1	C58	CAP.,100uF, ALUM ELECT,25V,20%, CE-BS Series	SUN ELECTRONIC INDUSTRIES CORP, 25CE100BS
12	2	L1,L2	IND.,0.6uH, XEL5030	COILCRAFT, XEL5030-601MEB
13	2	L3,L4	IND.,1.5uH, XEL5030	COILCRAFT, XEL5030-152MEB
14	1	Q1	XSTR., MOSFET, N-CH,40V,14A, DPAK (TO-252)	VISHAY, SUD50N04-8M8P-4GE3
15	8	R1,R9,R13,R14,R17,R 18,R23,R24	RES.,0 OHM,1/10W,0603,AEC-Q200	VISHAY, CRCW06030000Z0EA
16	5	R3,R4,R5,R6,R50	RES.,100k OHMS,1%,1/10W,0603	VISHAY, CRCW0603100KFKEA
17	1	R7	RES.,2.2 OHMS,5%,1/10W,0603	VISHAY, CRCW06032R20JNEA
18	4	R8,R10,R15,R16	RES.,1M OHM,1%,1/10W,0603	VISHAY, CRCW06031M00FKEA
19	5	R19,R22,R25,R28,R41	RES.,10k OHMS,1%,1/10W,0603	VISHAY, CRCW060310K0FKEA
20	3	R29,R30,R31	RES.,0 OHM,1/4W,1206	VISHAY, CRCW12060000Z0EA
21	1	R40	RES.,20k OHMS,1%,1/10W,0603	VISHAY, CRCW060320K0FKEA
22	1	R42	RES.,15k OHMS,1%,1/10W,0603	VISHAY, CRCW060315K0FKEA

23	1	R43	RES.,4.99k OHMS,1%,1/10W,0603	VISHAY, CRCW06034K99FKEA
24	1	R51	RES.,26.1k OHMS,1%,1/10W,0603	VISHAY, CRCW060326K1FKEA
25	1	R52	RES.,56.2k OHMS,1%,1/10W,0603	VISHAY, CRCW060356K2FKEA
26	1	R53	RES.,14k OHMS,1%,1/10W,0603	VISHAY, CRCW060314K0FKEA
27	1	R54	RES.,90.9k OHMS,1%,1/10W,0603	VISHAY, CRCW060390K9FKEA
28	1	R71	RES.,10k OHMS,1%,1/10W,0603	VISHAY, CRCW060310K0FKEA
29	1	R72	RES.,0.01OHM,1%,1W,2512, PWR, METAL, SENSE	VISHAY, WSL2512R0100FEA
30	1	U1	IC,18V,±5A, Synch. Buck Regulator, LQFN-48	ANALOG DEVICES, LT7200SAV#PBF

Additional Evaluation Kit Components

1	1	FB1	IND.,100 OHMS@100MHz, FERRITE BEAD,25%,8A,6mOHMS,1812	WURTH ELEKTRONIK, 74279226101
2	1	C59	CAP.,1uF, X5R,25V,10%,0402	MURATA, GRM155R61E105KA12D
3	4	C60,C61,C64,C65	CAP.,0.22uF, X5R,25V,10%,0402	MURATA, GRM155R61E224KE01D
4	2	C62,C63	CAP.,22uF, X7R,25V,10%,1210	MURATA, GRM32ER71E226KE15L
5	1	L5	IND.,0.33uH, PWR, SHIELDED, SMD	WURTH ELEKTRONIK, 744373360033
6	0	C8,C13,C17,C18,C55 (OPT)	CAP., OPTION, 0603	
7	0	C57 (OPT)	CAP., OPTION, 1206	
8	0	R2,R33,R34,R48,R55, R56,R57,R58,R59,R60, R62,R63,R64,R65,R66, R67,R68,R69,R70 (OPT)	RES., OPTION, 0603	
9	0	R32,R47 (OPT)	RES., OPTION, 1206	

Hardware for Evaluation Kit Only

1	16	E2,E3,E4,E5,E6,E12,E 14,E15,E16,E17,E18,E 19,E20,E21,E27,E28	TEST POINT, TURRET,0.094" MTG. HOLE, PCB 0.062" THK	MILL-MAX, 2501-2-00-80-00-00-07-0
2	19	E8,E9,E10,E11,E13,E2 2,E23,E24,E25,E26,E2	TEST POINT, TURRET,0.064" MTG. HOLE,PCB 0.062" THK	MILL-MAX, 2308-2-00-80-00-00-07-0

		9,E30,E31,E32,E33,E34,E35,E36,E37		
3	2	J1,J2	CONN., BANANA JACK, FEMALE, THT, NON-INSULATED, SWAGE,0.218"	KEYSTONE, 575-4
4	5	JP1,JP2,JP3,JP4,JP6	CONN., HDR,MALE,1x3,2m0000m,VERT,ST,THT	WURTH ELEKTRONIK, 62000311121
5	1	JP5	CONN., HDR,MALE,2x3,2mm,VERT,ST, THT	WURTH ELEKTRONIK, 62000621121
6	4	MP1,MP2,MP3,MP4	STANDOFF, NYLON,SNAP-ON,0.50"	KEYSTONE, 8833
7	6	XJP1,XJP2,XJP3,XJP4,XJP5,XJP6	CONN., SHUNT, FEMALE, 2-POS,2mm	WURTH ELEKTRONIK, 60800213421

Schematic Diagram

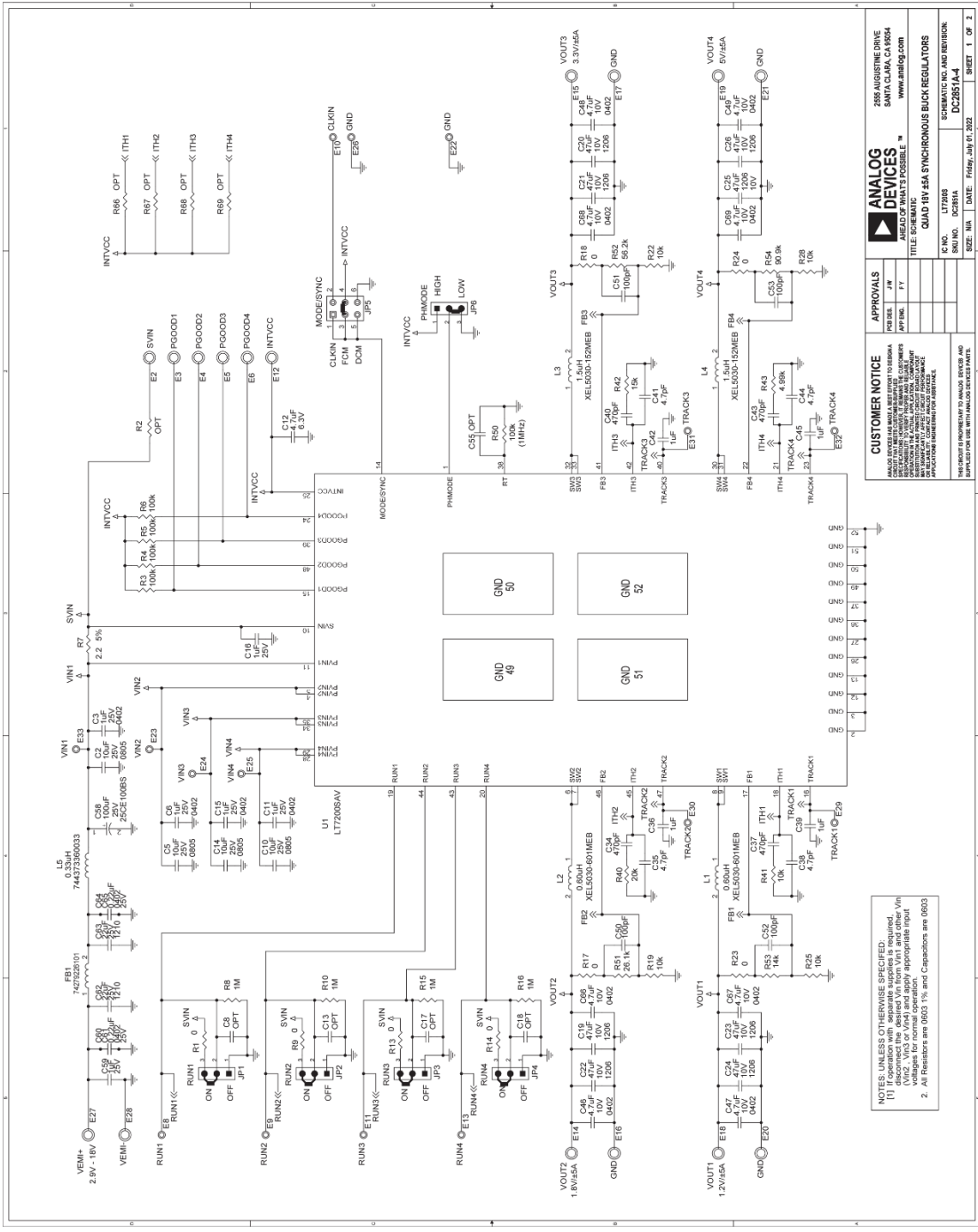

ANALOG DEVICES	
2662 AUGUSTINE DRIVE SANTA CLARA, CA 95054 www.analog.com	
ANGELIC HALL 13.02081E11	
TITLE: SCHEMATIC	
QUAD BY 5A SYNCHRONOUS BUCK REGULATORS	
IC NO. 177200S	SCHEMATIC NO. AND REVISION
SKU NO. DC2851A	DC2851A-4
SIZE: N/A	DATE: Friday, July 01, 2011
SHEET 1 OF 2	

CUSTOMER NOTICE:
ANALOG DEVICES PROVIDES DESIGN RESOURCES, INCLUDING REFERENCE DESIGNS, TO ASSIST OUR CUSTOMERS IN DEVELOPING THEIR APPLICATIONS. THESE RESOURCES ARE PROVIDED "AS IS" WITHOUT WARRANTY OF ANY KIND, EITHER EXPRESS OR IMPLIED, INCLUDING THE IMPLIED WARRANTIES OF MERCHANTABILITY AND FITNESS FOR A PARTICULAR PURPOSE. YOU ARE SOLELY RESPONSIBLE FOR THE PROTECTION OF YOUR PATENT RIGHTS. YOU MAY BE SUBJECT TO THIRD PARTY PATENT INFRINGEMENT CLAIMS. ANALOG DEVICES ASSUMES NO LIABILITY FOR ANY SUCH CLAIMS.

- NOTES: UNLESS OTHERWISE SPECIFIED:
1. Disconnect the desired Vin from Vm1 and other Vin sources for normal operation.
2. All Resistors are 0603 1% and Capacitors are 0603

Schematic Diagram (continued)

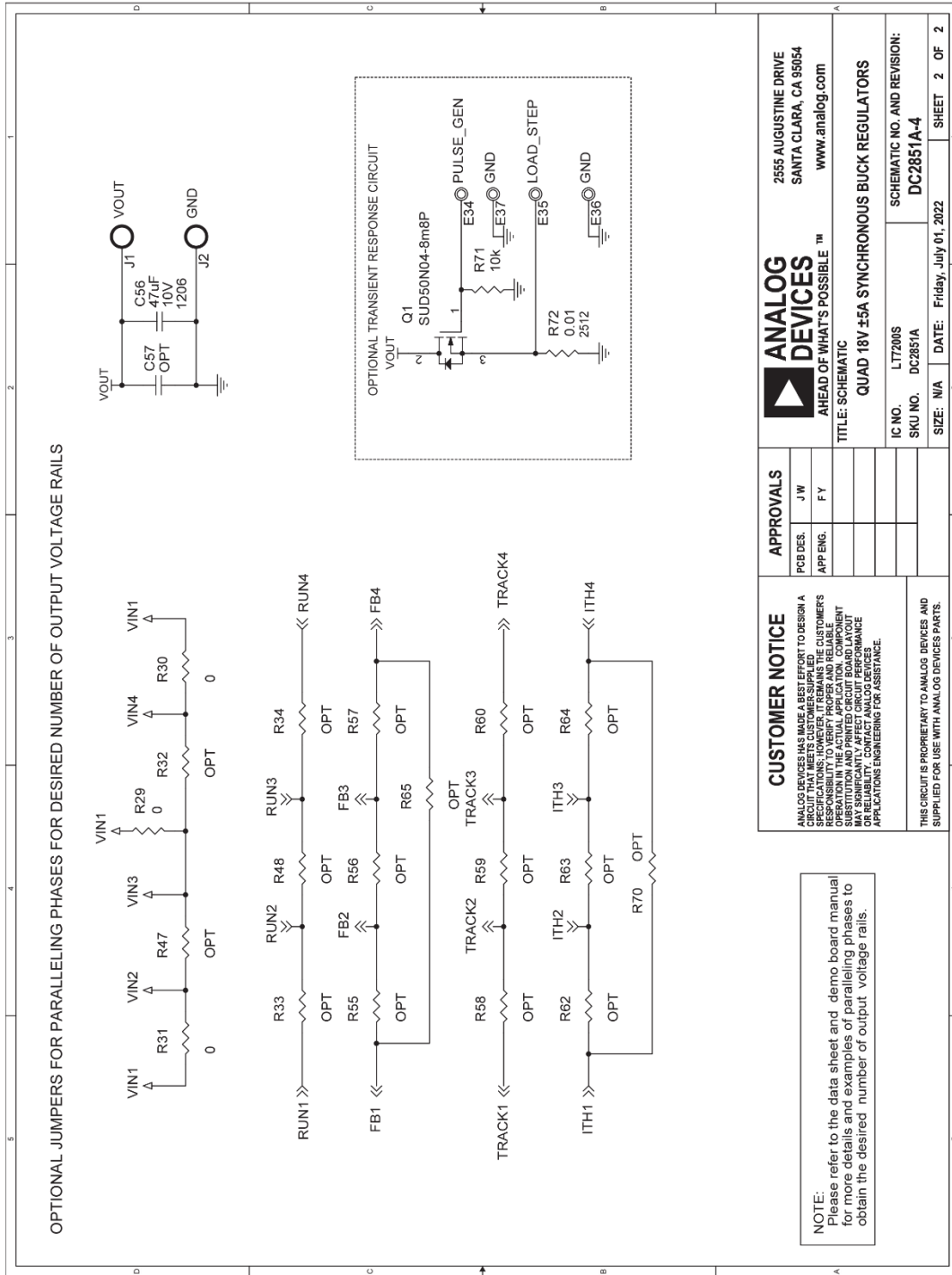

NOTE:
 Please refer to the data sheet and demo board manual for more details and examples of paralleling phases to obtain the desired number of output voltage rails.

CUSTOMER NOTICE ANALOG DEVICES HAS MADE A BEST EFFORT TO DESIGN A CIRCUIT THAT MEETS CUSTOMER SPECIFICATIONS. HOWEVER, IT REMAINS THE CUSTOMER'S RESPONSIBILITY TO VERIFY THE OPERATION IN THE ACTUAL APPLICATION. COMPONENT SUBSTITUTION AND PRINTED CIRCUIT BOARD LAYOUT MAY AFFECT PERFORMANCE. FOR ASSISTANCE OR RELIABILITY, CONTACT ANALOG DEVICES APPLICATIONS ENGINEERING FOR ASSISTANCE.		APPROVALS PCB DES. J W APP. ENG. F Y	
		ANALOG DEVICES 2555 AUGUSTINE DRIVE SANTA CLARA, CA 95054 www.analog.com	
TITLE: SCHEMATIC QUAD 18V ±5A SYNCHRONOUS BUCK REGULATORS		IC NO. LT7200S SKU NO. DC2851A SIZE: N/A DATE: Friday, July 01, 2022	
THIS CIRCUIT IS PROPRIETARY TO ANALOG DEVICES AND SUPPLIED FOR USE WITH ANALOG DEVICES PARTS.		SCHEMATIC NO. AND REVISION: DC2851A-4 SHEET 2 OF 2	

Revision History

DC2851A User Guide	REVISION DATE	DESCRIPTION	PAGES CHANGED
0	10/22	Initial release	—

