

Why you need MACHINE SAFETY GUARDS ??

Proper machine guarding is necessary to reduce machinery related incidents at workplace. There are many cases of amputations at work and hazards such as workers are struck by, caught in-between, and cut or stabbed by machines and tools. Our machine safety guards are suitable to be installed on rotating equipment such as Drilling Machines, Milling Machines, Lathe Machines and Bench Grinders.

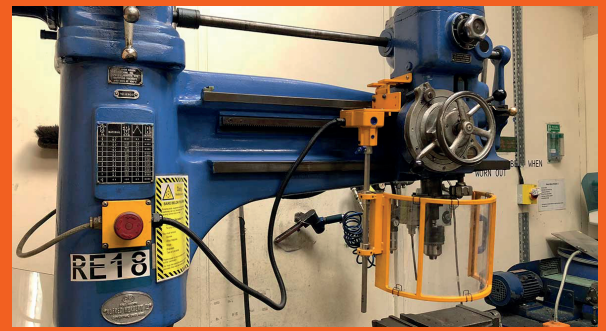

Safety Guard on Drilling Machine

Overview

This safety device is suitable for small, medium and large shaking arm Drilling Machines and other Shaking Arm Drilling Machines, and also suitable for safety protection of rotating equipment.

Features

- Using 6061 aluminum alloy, Q235 bracket surface rust treatment, explosion-proof PC transparent board.
- Semi-circular shield is molded and processed, more reasonable with machine tools.
- The transparency of technical grade explosion PC transparent diaphragm is 93% with thickness from 4mm, which is practical and solid. Adjustable up and down, 180 degree switch type of rotating shaft level, easy to clamping workpiece, convenient and simple operation.



Can be Adjusted up and down
600mm~1000mm

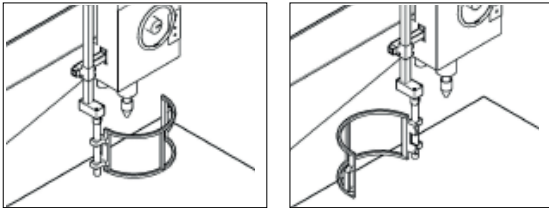
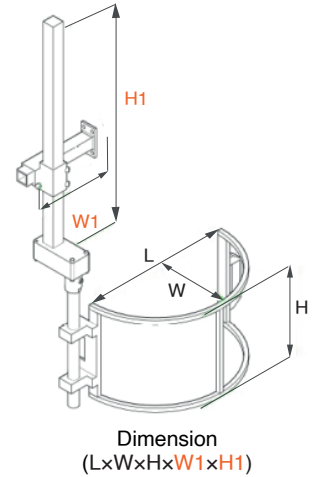

180° Degree switch type of rotating shaft level

Model	Switch	Dimension (LxWxHxW1xH1) mm
TB-DRILLGUARD-300	Can be equipped with safety interlock switch	300x150x220x210x600
TB-DRILLGUARD-500		500x250x240x210x800

Safety Guard on Drilling & Milling Machine

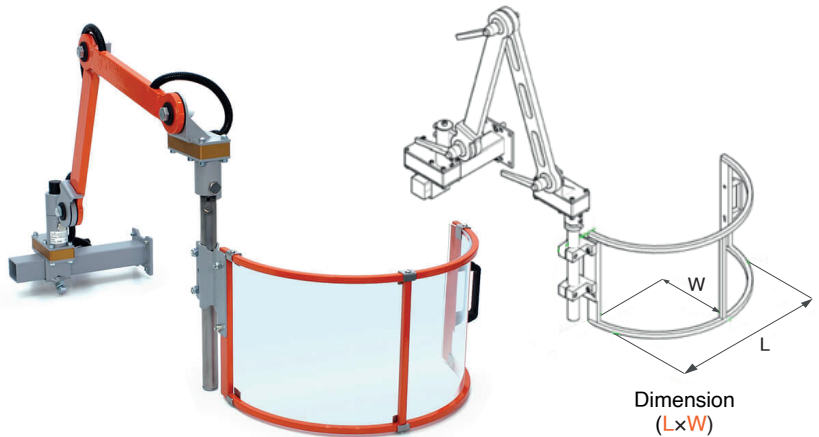
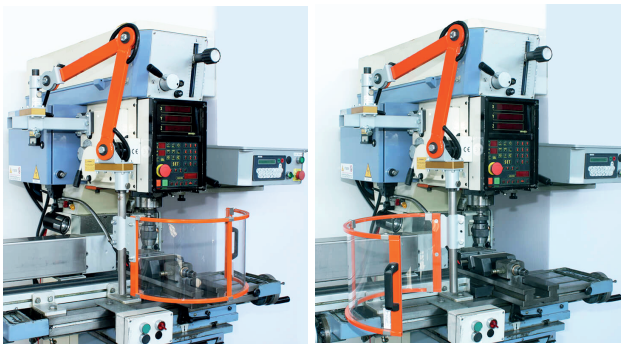

Dimension (LxW)

Overview

This safety device is suitable for small, medium and Large Milling Machines, Drilling and Milling Machines, Large Drilling Machines, also suitable for rotating equipment safety protection.

Features

- Using 6061 aluminum alloy, Q235 bracket surface rust treatment, explosion-proof PC transparent board.
- Semi-circular shield is molded and processed, more reasonable with machine tools.
- The transparency of technical grade explosion PC transparent diaphragm is 93% with thickness from 4mm, which is practical and solid.
- The horizontally movement method is convenient for clamping workpieces and various operations, which is convenient and simple.

Model	Switch	Dimension (LxW) mm
TB-MILLGUARD-400	Can be equipped with safety interlock switch	400x240
TB-MILLGUARD-500		500x240

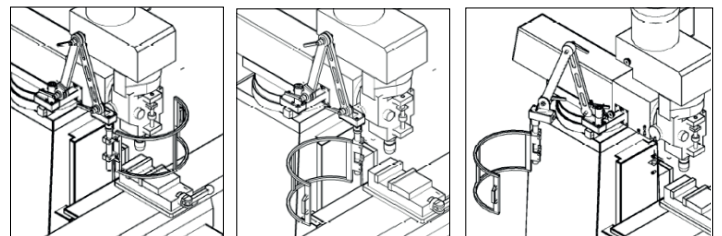

Fully open Protective Shield

Safety Guard on Small or Medium Lathe Machine



Semi Circle Shape Safety Guard

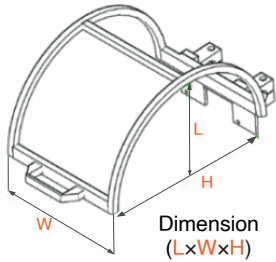

Dimension (LxWxH)

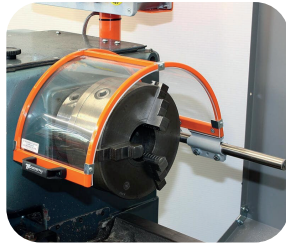

Rhombus Shape Safety Guard

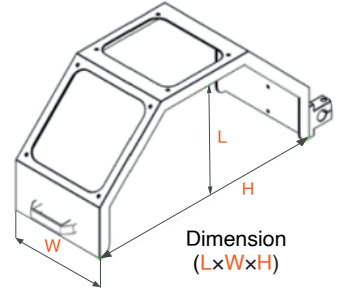
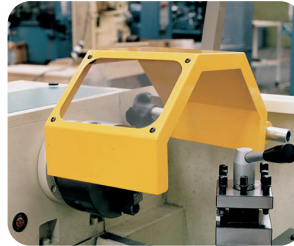

Dimension (LxWxH)

Shape	Model	Switch	Dimension (LxWxH)
Semi Circle Shape	TB-LATHEGUARD-400	Can be equipped with safety interlock switch	400x240x200
Semi Circle Shape	TB-LATHEGUARD-500		500x240x250
Semi Circle Shape	TB-LATHEGUARD-600		600x300x300
Rhombus Shape	TB-LATHEGUARD-400R		400x200x200

Overview

This device can be used for **Small and Medium Horizontal Lathes** and suitable for horizontal turntable equipment safety protection.

Features

- Using 6061 aluminum alloy, Q235 bracket surface rust treatment, explosion-proof PC transparent board.
- Semi-circular shield is molded and processed, more reasonable with machine tools.
- The transparency of technical grade explosion PC transparent diaphragm is 93% with thickness from 4mm, which is practical and solid.
- The upper and lower shaft lift cover is adopted, which is easy to clamping workpiece and various operations, convenient and simple.

Safety Guard on Large Lathe Machine

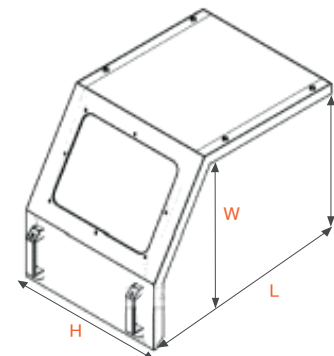
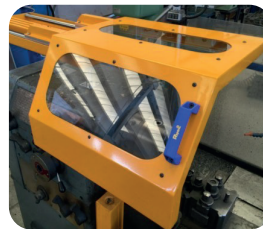

Dimension (LxWxH)

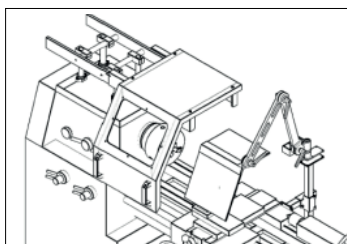
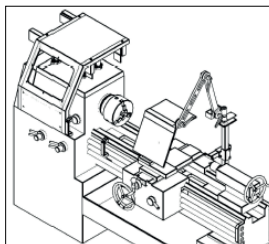

Can be move **back and forth**

Model	Switch	Dimension (LxWxH)
TB-LATHEGUARD - 470	Can be equipped with safety interlock switch	470x350x975
TB-LATHEGUARD - 570		570x395x1130

Overview

This device can be used for small, medium and large horizontal lathes, and is also suitable for horizontal turntable equipment safety protection.

Features

- Using 6061 aluminum alloy, Q235 steel plate welding, explosion PC transparent diaphragm, technical grade linear guided rail.
- Industrial heavy-duty linear guide rails are more stable and durable.
- The transparency of technical grade explosion PC transparent diaphragm is 93% with thickness from 4mm to 5mm, which is practical and solid.
- The horizontally movement method is convenient for clamping workpieces and various operations, which is convenient and simple.
- Using PLD/safety type 3/4, 1NC+1NC / 1NO+1NC safety switch or adding a locking force safety switch (the guard can only be opened after the equipment has stopped).

Safety Guard on Bench Grinders

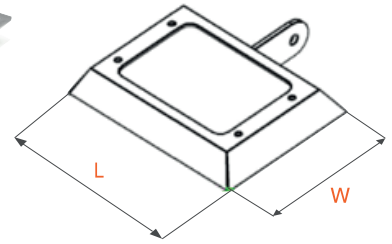
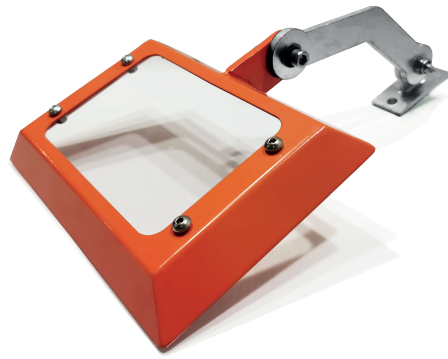
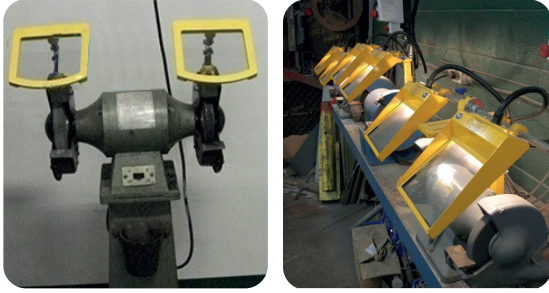

Dimension (LxWxH)

Overview

This device can be used for small and medium vertical sanders and bench grinders, also suitable for horizontal turntable equipment safety protection

Features

- Use Q235 bracket, explosion-proof PC transparent board.
- Welding and molding processing, more reasonable with machine tools .
- Industrial grade explosion-proof PC transparent board,transparency is 93%, board thickness is 4mm, practical and sturdy.
- Adopt up and down swinging adjustment method, easy and simple operation.

Model	Switch	Dimension (LxWxH)
TB-BGGUARD-200	Can be equipped with safety interlock switch	200x140

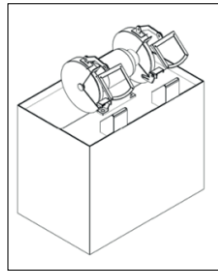

Safety location

Adopt can be swinging adjustment up and down

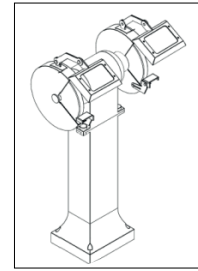

Safety location

Adopt can be swinging adjustment up and down

Safety Guard for Tool Post

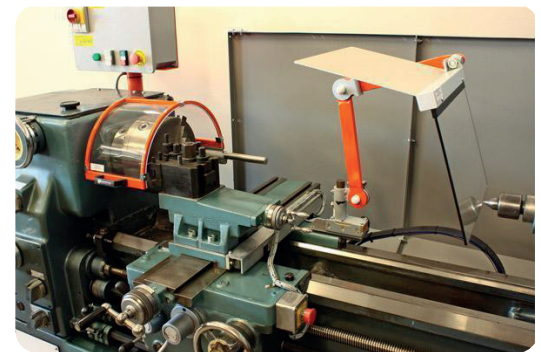
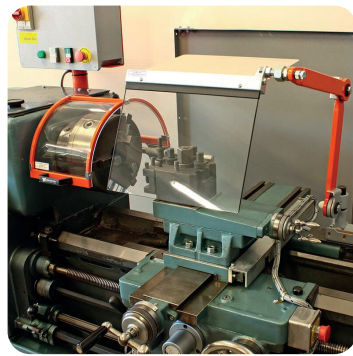

Model	Switch	Dimension (LxW)
TB-ToolPost-300	Can be equipped with safety interlock switch	300x350
TB-ToolPost-350		350x400
TB-ToolPost-400		400x450

Overview

This device can be used for **Small and Medium Horizontal Lathes** and suitable for horizontal turntable equipment safety protection.

Features

- Using 6061 aluminum alloy, Q235 bracket surface rust treatment, explosion-proof PC transparent board.
- Semi-circular shield is molded and processed, more reasonable with machine tools.
- The transparency of technical grade explosion PC transparent diaphragm is 93% with thickness from 4mm , which is practical and solid.
- The upper and lower shaft lift cover is adopted,which is easy to clamping workpiece and various operations, convenient and simple.

HUP HONG MACHINERY PTE LTD | SINGAPORE HQ

+65 6296 7711

sales@huphong.com.sg

101 Kitchener Road, #01-12/14
 Jalan Besar Plaza, Singapore 208511

+65 6297 1963



**SAFETY
 GUARD**
 QR Code
www.huphong.com.sg

Website : www.huphong.com.sg