

Thin Film Precision Chip Resistor



RoHS
Compliant



Features

- Advanced thin film technology
- Very tight tolerance 0.1%
- Low TCR

Construction

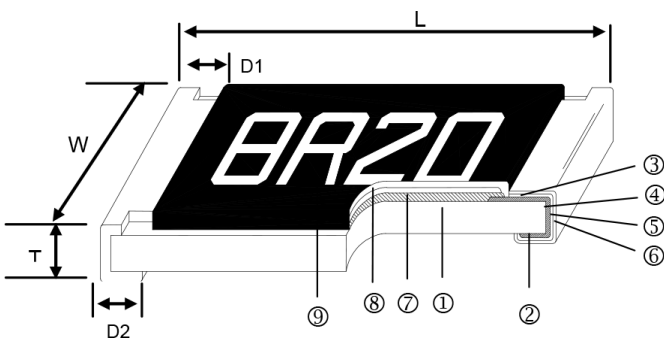

1	Alumina Substrate
2	Bottom Electrode
3	Top Electrode
4	Edge Electrode
5	Barrier Layer
6	External Electrode
7	Resistor Layer
8	Overcoat
9	Marking

Dimensions

Size (Inch)	L	W	T	D1	D2
0402	1 ±0.05	0.5 ±0.05	0.3 ±0.05	0.2 ±0.1	0.2 ±0.1
0603	1.55 ±0.1	0.8 ±0.1	0.45 ±0.1	0.3 ±0.2	0.3 ±0.2
0805	2 ±0.15	1.25 ±0.15	0.55 ±0.1	0.3 ±0.2	0.4 ±0.2
1206	3.05 ±0.15	1.55 ±0.15	0.55 ±0.1	0.42 ±0.2	0.35 ±0.25
1210	3.1 ±0.15	2.4 ±0.15	0.55 ±0.1	0.4 ±0.2	0.55 ±0.25
2010	4.9 ±0.15	2.4 ±0.15	0.55 ±0.1	0.6 ±0.3	0.5 ±0.25
2512	6.3 ±0.15	3.1 ±0.15	0.55 ±0.1	0.6 ±0.3	0.5 ±0.25

Dimensions : Millimetres

Derating Curve

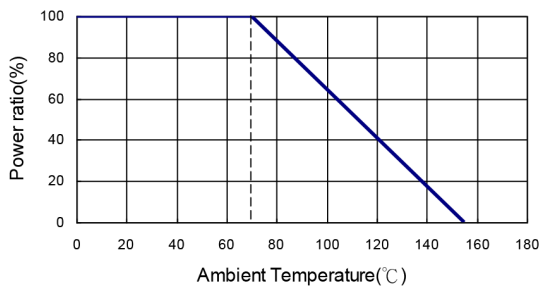

Thin Film Precision Chip Resistor

Standard Electrical Specifications

Size (Inch)	Power Rating @ 70°C	Operating Temperature Range	Max. Operating Voltage	Max. Overload Voltage	Tolerance	Resistance Range	TCR (PPM/°C)
0402	1/16 W	-55°C ~ +155°C	25V	50V	0.1%	10Ω - 255KΩ	±25
0603	1/16 W		50V	100V		4.7Ω - 1MΩ	±25
0805	1/10 W		100V	200V		4.7Ω - 2MΩ	±25
1206	1/8 W		150V	300V		4.7Ω - 2.49MΩ	±25
1210	1/4 W		150V	300V		4.7Ω - 3MΩ	±25
2010	1/4 W						
2512	1/2 W						

Environmental Characteristics

Item	Tolerance >0.1%	Test Method
Temperature Coefficient Resistor (TCR)	As per Spec.	MIL-STD-202 Method 304 +25/-55/+25/+125/+25°C
Short Time Overload	ΔR±0.2%	JIS-C-5201-1 4.13 RCWV*2.5 or Max. overload voltage whichever is lower for 5 seconds
Insulation Resistance	>9999 MΩ	MIL-STD-202 Method 302 Apply 100V _{DC} for 1 minute
Endurance	ΔR±0.2% >7kΩ → ΔR±0.5% ≤7kΩ → ΔR±0.2%	MIL-STD-202 Method 108A 70±2°C, RCWV for 1000hrs with 1.5hrs "ON" and 0.5hrs "OFF"
Damp Heat with Load	ΔR±0.3%	MIL-STD-202 Method 103B 40±2°C, 90 ~ 95% R.H. RCWV for 1000hrs with 1.5hrs "ON" and 0.5hrs "OFF"
Bending Strength	ΔR±0.1%	JIS-C-5201-1 4.33 Bending amplitude 3mm for 10 seconds
Solderability	95% min. coverage	MIL-STD-202 Method 208H 245 ±5°C for 3 seconds
Resistance to Soldering Heat	ΔR±0.1%	MIL-STD-202 Method 210E 260±5°C for 10 seconds
Dielectric Withstand Voltage	-	MIL-STD-202 Method 301 Max. overload voltage for 1 minute
Low Temperature Operation	ΔR±0.2%	JIS-C-5201-1 4.36 1 hour, -65°C, followed by 45 minutes of RCWV
High Temperature Exposure	ΔR±0.5%	MIL-STD-202 Method 108 at +155°C for 1000hrs

*RCWV(Rated continuous working voltage)= $\sqrt{(P \cdot R)}$ or Max. Operating voltage whichever is lower

Storage Temperature: 15~28°C; Humidity: < 80%RH

Thin Film Precision Chip Resistor

Soldering Condition

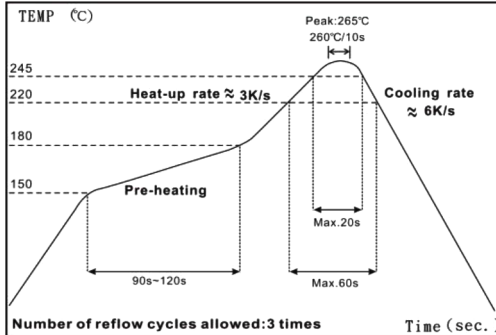

IR Reflow Soldering

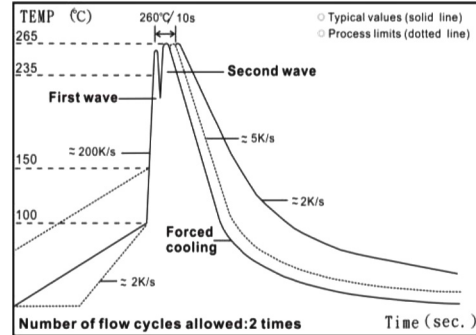

Wave Soldering (Flow Soldering)

- (1) Time of IR reflow soldering at maximum temperature point 260°C = 10s
- (2) Time of wave soldering at maximum temperature point 260°C = 10s
- (3) Time of soldering iron at maximum temperature point 410°C = 5s

Packaging

Packing Quantity & Reel Specifications

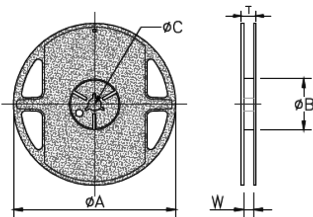

Size (Inch)	ØA	ØB	ØC	W	T	Paper Tape (EA)	Emboss Plastic Tape (EA)
0402	178 ±1	60 +1	13.5 ±0.7	9.5 ±1	11.5 ±1	10,000	-
0603	178 ±1	60 +1	13.5 ±0.7	9.5 ±1	11.5 ±1	5,000	-
0805	178 ±1	60 +1	13.5 ±0.7	9.5 ±1	11.5 ±1	5,000	-
1206	178 ±1	60 +1	13.5 ±0.7	9.5 ±1	11.5 ±1	5,000	-
1210	178 ±1	60 ±1	13.5 ±0.7	9.5 ±1	11.5 ±1	5,000	-
2010	178 ±1	60 +1	13.5 ±0.7	13.5 ±1	15.5 ±1	-	4,000
2512	178 ±1	60 +1	13.5 ±0.7	13.5 ±1	15.5 ±1	-	4,000

Dimensions : Millimetres

Thin Film Precision Chip Resistor

Paper Tape Specifications

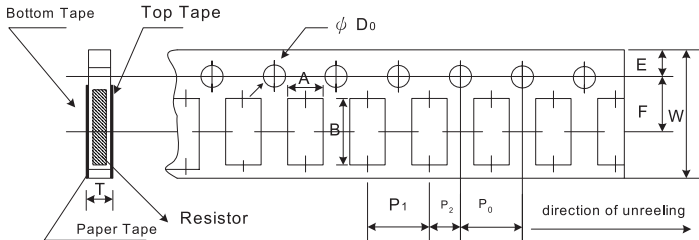

Size (Inch)	A	B	W	E	F	P ₀	P ₁	P ₂	ΦD ₀	T
0402	0.7±0.05	1.16±0.05	8±0.1	1.75±0.05	3.5±0.05	4±0.1	2±0.05	2 ±0.05	1.55±0.05	0.4±0.03
0603	1.1±0.05	1.9 ±0.05					4±0.1			0.6±0.03
0805	1.6±0.05	2.37±0.05					4±0.1			0.75±0.05
1206	2±0.05	3.55±0.05				4±0.05	1.6±0.1			
1210	2.75±0.05	3.4 ±0.05				1.6±0.1				

Dimensions : Millimetres

Peel force of top cover tape

The peel speed shall be about 300mm/min±5%

The peel force of top cover tape shall be between 8gf to 60gf

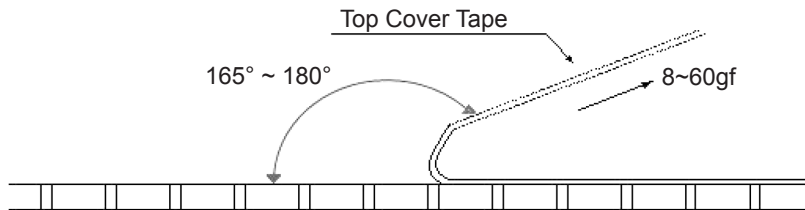

Emboss Plastic Tape Specifications

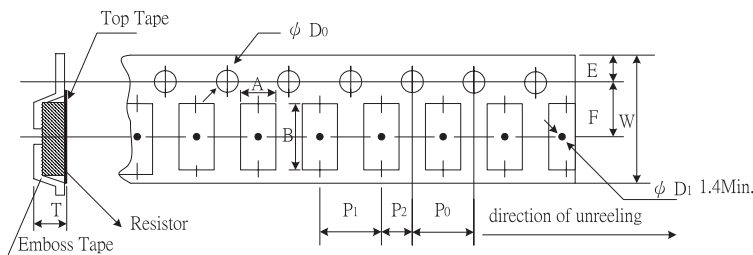

Size (Inch)	A	B	W	E	F	P ₀	P ₁	P ₂	ΦD ₀	T
2010	2.85±0.1	5.45±0.1	12±0.1	1.75±0.1	5.5±0.05	4±0.05	4±0.1	2±0.05	1.5+0.1	1±0.2
2512	3.40±0.1	6.65±0.1								

Dimensions : Millimetres

Peel force of top cover tape

The peel speed shall be about 300mm/min±5%

The peel force of top cover tape shall be between 20gf to 80gf

Thin Film Precision Chip Resistor

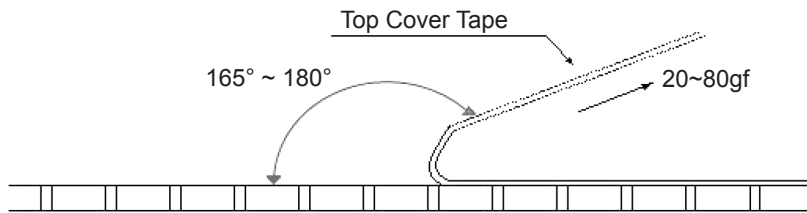

Recommend Land Pattern

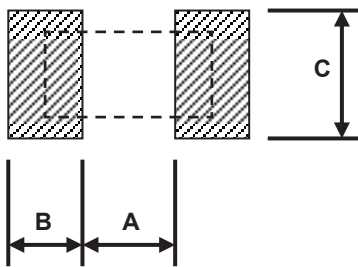

Size (Inch)	A	B	C
0402	0.5	0.5	0.6±0.2
0603	0.8	1	0.9±0.2
0805	1	1	1.35±0.2
1206	2	1.15	1.7±0.2
1210	2	1.15	2.5±0.2
2010	3.6	1.4	2.5±0.2
2512	4.9	1.6	3.1±0.2

Dimensions : Millimetres

Part Number Table

Description	Part Number	Description	Part Number
Resistor, Thin Film, 10R, 0.1%, ±25ppm, 1/16W, 0402	MC004219	Resistor, Thin Film, 17R4, 0.1%, ±25ppm, 1/16W, 0402	MC004242
Resistor, Thin Film, 10R2, 0.1%, ±25ppm, 1/16W, 0402	MC004220	Resistor, Thin Film, 17R8, 0.1%, ±25ppm, 1/16W, 0402	MC004243
Resistor, Thin Film, 10R5, 0.1%, ±25ppm, 1/16W, 0402	MC004221	Resistor, Thin Film, 18R2, 0.1%, ±25ppm, 1/16W, 0402	MC004244
Resistor, Thin Film, 10R7, 0.1%, ±25ppm, 1/16W, 0402	MC004222	Resistor, Thin Film, 18R7, 0.1%, ±25ppm, 1/16W, 0402	MC004245
Resistor, Thin Film, 11R, 0.1%, ±25ppm, 1/16W, 0402	MC004223	Resistor, Thin Film, 19R1, 0.1%, ±25ppm, 1/16W, 0402	MC004246
Resistor, Thin Film, 11R3, 0.1%, ±25ppm, 1/16W, 0402	MC004224	Resistor, Thin Film, 19R6, 0.1%, ±25ppm, 1/16W, 0402	MC004247
Resistor, Thin Film, 11R5, 0.1%, ±25ppm, 1/16W, 0402	MC004225	Resistor, Thin Film, 20R, 0.1%, ±25ppm, 1/16W, 0402	MC004248
Resistor, Thin Film, 11R8, 0.1%, ±25ppm, 1/16W, 0402	MC004226	Resistor, Thin Film, 20R5, 0.1%, ±25ppm, 1/16W, 0402	MC004249
Resistor, Thin Film, 12R1, 0.1%, ±25ppm, 1/16W, 0402	MC004227	Resistor, Thin Film, 21R, 0.1%, ±25ppm, 1/16W, 0402	MC004250
Resistor, Thin Film, 12R4, 0.1%, ±25ppm, 1/16W, 0402	MC004228	Resistor, Thin Film, 21R5, 0.1%, ±25ppm, 1/16W, 0402	MC004251
Resistor, Thin Film, 12R7, 0.1%, ±25ppm, 1/16W, 0402	MC004229	Resistor, Thin Film, 22R1, 0.1%, ±25ppm, 1/16W, 0402	MC004252
Resistor, Thin Film, 13R, 0.1%, ±25ppm, 1/16W, 0402	MC004230	Resistor, Thin Film, 22R6, 0.1%, ±25ppm, 1/16W, 0402	MC004253
Resistor, Thin Film, 13R3, 0.1%, ±25ppm, 1/16W, 0402	MC004231	Resistor, Thin Film, 23R2, 0.1%, ±25ppm, 1/16W, 0402	MC004254
Resistor, Thin Film, 13R7, 0.1%, ±25ppm, 1/16W, 0402	MC004232	Resistor, Thin Film, 23R7, 0.1%, ±25ppm, 1/16W, 0402	MC004255
Resistor, Thin Film, 14R, 0.1%, ±25ppm, 1/16W, 0402	MC004233	Resistor, Thin Film, 24R3, 0.1%, ±25ppm, 1/16W, 0402	MC004256
Resistor, Thin Film, 14R3, 0.1%, ±25ppm, 1/16W, 0402	MC004234	Resistor, Thin Film, 24R9, 0.1%, ±25ppm, 1/16W, 0402	MC004257
Resistor, Thin Film, 14R7, 0.1%, ±25ppm, 1/16W, 0402	MC004235	Resistor, Thin Film, 25R5, 0.1%, ±25ppm, 1/16W, 0402	MC004258
Resistor, Thin Film, 15R, 0.1%, ±25ppm, 1/16W, 0402	MC004236	Resistor, Thin Film, 26R1, 0.1%, ±25ppm, 1/16W, 0402	MC004259
Resistor, Thin Film, 15R4, 0.1%, ±25ppm, 1/16W, 0402	MC004237	Resistor, Thin Film, 26R7, 0.1%, ±25ppm, 1/16W, 0402	MC004260
Resistor, Thin Film, 15R8, 0.1%, ±25ppm, 1/16W, 0402	MC004238	Resistor, Thin Film, 27R4, 0.1%, ±25ppm, 1/16W, 0402	MC004261
Resistor, Thin Film, 16R2, 0.1%, ±25ppm, 1/16W, 0402	MC004239	Resistor, Thin Film, 28R, 0.1%, ±25ppm, 1/16W, 0402	MC004262
Resistor, Thin Film, 16R5, 0.1%, ±25ppm, 1/16W, 0402	MC004240	Resistor, Thin Film, 29R4, 0.1%, ±25ppm, 1/16W, 0402	MC004263
Resistor, Thin Film, 16R9, 0.1%, ±25ppm, 1/16W, 0402	MC004241	Resistor, Thin Film, 31R6, 0.1%, ±25ppm, 1/16W, 0402	MC004264

www.element14.com
www.farnell.com
www.newark.com

Thin Film Precision Chip Resistor

Description	Part Number	Description	Part Number
Resistor, Thin Film, 32R4, 0.1%, ±25ppm, 1/16W, 0402	MC004265	Resistor, Thin Film, 86R6, 0.1%, ±25ppm, 1/16W, 0402	MC004306
Resistor, Thin Film, 33R2, 0.1%, ±25ppm, 1/16W, 0402	MC004266	Resistor, Thin Film, 88R7, 0.1%, ±25ppm, 1/16W, 0402	MC004307
Resistor, Thin Film, 34R, 0.1%, ±25ppm, 1/16W, 0402	MC004267	Resistor, Thin Film, 90R9, 0.1%, ±25ppm, 1/16W, 0402	MC004308
Resistor, Thin Film, 34R8, 0.1%, ±25ppm, 1/16W, 0402	MC004268	Resistor, Thin Film, 93R1, 0.1%, ±25ppm, 1/16W, 0402	MC004309
Resistor, Thin Film, 35R7, 0.1%, ±25ppm, 1/16W, 0402	MC004269	Resistor, Thin Film, 95R3, 0.1%, ±25ppm, 1/16W, 0402	MC004310
Resistor, Thin Film, 36R5, 0.1%, ±25ppm, 1/16W, 0402	MC004270	Resistor, Thin Film, 97R6, 0.1%, ±25ppm, 1/16W, 0402	MC004311
Resistor, Thin Film, 37R4, 0.1%, ±25ppm, 1/16W, 0402	MC004271	Resistor, Thin Film, 100R, 0.1%, ±25ppm, 1/16W, 0402	MC004312
Resistor, Thin Film, 38R3, 0.1%, ±25ppm, 1/16W, 0402	MC004272	Resistor, Thin Film, 102R, 0.1%, ±25ppm, 1/16W, 0402	MC004313
Resistor, Thin Film, 39R2, 0.1%, ±25ppm, 1/16W, 0402	MC004273	Resistor, Thin Film, 105R, 0.1%, ±25ppm, 1/16W, 0402	MC004314
Resistor, Thin Film, 40R2, 0.1%, ±25ppm, 1/16W, 0402	MC004274	Resistor, Thin Film, 107R, 0.1%, ±25ppm, 1/16W, 0402	MC004315
Resistor, Thin Film, 41R2, 0.1%, ±25ppm, 1/16W, 0402	MC004275	Resistor, Thin Film, 110R, 0.1%, ±25ppm, 1/16W, 0402	MC004316
Resistor, Thin Film, 42R2, 0.1%, ±25ppm, 1/16W, 0402	MC004276	Resistor, Thin Film, 113R, 0.1%, ±25ppm, 1/16W, 0402	MC004317
Resistor, Thin Film, 43R2, 0.1%, ±25ppm, 1/16W, 0402	MC004277	Resistor, Thin Film, 115R, 0.1%, ±25ppm, 1/16W, 0402	MC004318
Resistor, Thin Film, 44R2, 0.1%, ±25ppm, 1/16W, 0402	MC004278	Resistor, Thin Film, 118R, 0.1%, ±25ppm, 1/16W, 0402	MC004319
Resistor, Thin Film, 45R3, 0.1%, ±25ppm, 1/16W, 0402	MC004279	Resistor, Thin Film, 121R, 0.1%, ±25ppm, 1/16W, 0402	MC004320
Resistor, Thin Film, 46R4, 0.1%, ±25ppm, 1/16W, 0402	MC004280	Resistor, Thin Film, 124R, 0.1%, ±25ppm, 1/16W, 0402	MC004321
Resistor, Thin Film, 47R5, 0.1%, ±25ppm, 1/16W, 0402	MC004281	Resistor, Thin Film, 127R, 0.1%, ±25ppm, 1/16W, 0402	MC004322
Resistor, Thin Film, 48R7, 0.1%, ±25ppm, 1/16W, 0402	MC004282	Resistor, Thin Film, 130R, 0.1%, ±25ppm, 1/16W, 0402	MC004323
Resistor, Thin Film, 49R9, 0.1%, ±25ppm, 1/16W, 0402	MC004283	Resistor, Thin Film, 133R, 0.1%, ±25ppm, 1/16W, 0402	MC004324
Resistor, Thin Film, 51R1, 0.1%, ±25ppm, 1/16W, 0402	MC004284	Resistor, Thin Film, 137R, 0.1%, ±25ppm, 1/16W, 0402	MC004325
Resistor, Thin Film, 52R3, 0.1%, ±25ppm, 1/16W, 0402	MC004285	Resistor, Thin Film, 140R, 0.1%, ±25ppm, 1/16W, 0402	MC004326
Resistor, Thin Film, 53R6, 0.1%, ±25ppm, 1/16W, 0402	MC004286	Resistor, Thin Film, 143R, 0.1%, ±25ppm, 1/16W, 0402	MC004327
Resistor, Thin Film, 54R9, 0.1%, ±25ppm, 1/16W, 0402	MC004287	Resistor, Thin Film, 147R, 0.1%, ±25ppm, 1/16W, 0402	MC004328
Resistor, Thin Film, 56R2, 0.1%, ±25ppm, 1/16W, 0402	MC004288	Resistor, Thin Film, 150R, 0.1%, ±25ppm, 1/16W, 0402	MC004329
Resistor, Thin Film, 57R6, 0.1%, ±25ppm, 1/16W, 0402	MC004289	Resistor, Thin Film, 154R, 0.1%, ±25ppm, 1/16W, 0402	MC004330
Resistor, Thin Film, 59R, 0.1%, ±25ppm, 1/16W, 0402	MC004290	Resistor, Thin Film, 158R, 0.1%, ±25ppm, 1/16W, 0402	MC004331
Resistor, Thin Film, 60R4, 0.1%, ±25ppm, 1/16W, 0402	MC004291	Resistor, Thin Film, 162R, 0.1%, ±25ppm, 1/16W, 0402	MC004332
Resistor, Thin Film, 61R9, 0.1%, ±25ppm, 1/16W, 0402	MC004292	Resistor, Thin Film, 165R, 0.1%, ±25ppm, 1/16W, 0402	MC004333
Resistor, Thin Film, 63R4, 0.1%, ±25ppm, 1/16W, 0402	MC004293	Resistor, Thin Film, 169R, 0.1%, ±25ppm, 1/16W, 0402	MC004334
Resistor, Thin Film, 64R9, 0.1%, ±25ppm, 1/16W, 0402	MC004294	Resistor, Thin Film, 174R, 0.1%, ±25ppm, 1/16W, 0402	MC004335
Resistor, Thin Film, 66R5, 0.1%, ±25ppm, 1/16W, 0402	MC004295	Resistor, Thin Film, 178R, 0.1%, ±25ppm, 1/16W, 0402	MC004336
Resistor, Thin Film, 68R1, 0.1%, ±25ppm, 1/16W, 0402	MC004296	Resistor, Thin Film, 182R, 0.1%, ±25ppm, 1/16W, 0402	MC004337
Resistor, Thin Film, 69R8, 0.1%, ±25ppm, 1/16W, 0402	MC004297	Resistor, Thin Film, 187R, 0.1%, ±25ppm, 1/16W, 0402	MC004338
Resistor, Thin Film, 71R5, 0.1%, ±25ppm, 1/16W, 0402	MC004298	Resistor, Thin Film, 191R, 0.1%, ±25ppm, 1/16W, 0402	MC004339
Resistor, Thin Film, 73R2, 0.1%, ±25ppm, 1/16W, 0402	MC004299	Resistor, Thin Film, 196R, 0.1%, ±25ppm, 1/16W, 0402	MC004340
Resistor, Thin Film, 75R, 0.1%, ±25ppm, 1/16W, 0402	MC004300	Resistor, Thin Film, 200R, 0.1%, ±25ppm, 1/16W, 0402	MC004341
Resistor, Thin Film, 76R8, 0.1%, ±25ppm, 1/16W, 0402	MC004301	Resistor, Thin Film, 205R, 0.1%, ±25ppm, 1/16W, 0402	MC004342
Resistor, Thin Film, 78R7, 0.1%, ±25ppm, 1/16W, 0402	MC004302	Resistor, Thin Film, 210R, 0.1%, ±25ppm, 1/16W, 0402	MC004343
Resistor, Thin Film, 80R6, 0.1%, ±25ppm, 1/16W, 0402	MC004303	Resistor, Thin Film, 215R, 0.1%, ±25ppm, 1/16W, 0402	MC004344
Resistor, Thin Film, 82R5, 0.1%, ±25ppm, 1/16W, 0402	MC004304	Resistor, Thin Film, 221R, 0.1%, ±25ppm, 1/16W, 0402	MC004345
Resistor, Thin Film, 84R5, 0.1%, ±25ppm, 1/16W, 0402	MC004305	Resistor, Thin Film, 226R, 0.1%, ±25ppm, 1/16W, 0402	MC004346

www.element14.com
www.farnell.com
www.newark.com



Thin Film Precision Chip Resistor

Description	Part Number	Description	Part Number
Resistor, Thin Film, 232R, 0.1%, ±25ppm, 1/16W, 0402	MC004347	Resistor, Thin Film, 665R, 0.1%, ±25ppm, 1/16W, 0402	MC004388
Resistor, Thin Film, 237R, 0.1%, ±25ppm, 1/16W, 0402	MC004348	Resistor, Thin Film, 681R, 0.1%, ±25ppm, 1/16W, 0402	MC004389
Resistor, Thin Film, 243R, 0.1%, ±25ppm, 1/16W, 0402	MC004349	Resistor, Thin Film, 698R, 0.1%, ±25ppm, 1/16W, 0402	MC004390
Resistor, Thin Film, 249R, 0.1%, ±25ppm, 1/16W, 0402	MC004350	Resistor, Thin Film, 715R, 0.1%, ±25ppm, 1/16W, 0402	MC004391
Resistor, Thin Film, 255R, 0.1%, ±25ppm, 1/16W, 0402	MC004351	Resistor, Thin Film, 732R, 0.1%, ±25ppm, 1/16W, 0402	MC004392
Resistor, Thin Film, 261R, 0.1%, ±25ppm, 1/16W, 0402	MC004352	Resistor, Thin Film, 750R, 0.1%, ±25ppm, 1/16W, 0402	MC004393
Resistor, Thin Film, 267R, 0.1%, ±25ppm, 1/16W, 0402	MC004353	Resistor, Thin Film, 768R, 0.1%, ±25ppm, 1/16W, 0402	MC004394
Resistor, Thin Film, 274R, 0.1%, ±25ppm, 1/16W, 0402	MC004354	Resistor, Thin Film, 787R, 0.1%, ±25ppm, 1/16W, 0402	MC004395
Resistor, Thin Film, 280R, 0.1%, ±25ppm, 1/16W, 0402	MC004355	Resistor, Thin Film, 806R, 0.1%, ±25ppm, 1/16W, 0402	MC004396
Resistor, Thin Film, 294R, 0.1%, ±25ppm, 1/16W, 0402	MC004356	Resistor, Thin Film, 825R, 0.1%, ±25ppm, 1/16W, 0402	MC004397
Resistor, Thin Film, 316R, 0.1%, ±25ppm, 1/16W, 0402	MC004357	Resistor, Thin Film, 845R, 0.1%, ±25ppm, 1/16W, 0402	MC004398
Resistor, Thin Film, 324R, 0.1%, ±25ppm, 1/16W, 0402	MC004358	Resistor, Thin Film, 866R, 0.1%, ±25ppm, 1/16W, 0402	MC004399
Resistor, Thin Film, 332R, 0.1%, ±25ppm, 1/16W, 0402	MC004359	Resistor, Thin Film, 887R, 0.1%, ±25ppm, 1/16W, 0402	MC004400
Resistor, Thin Film, 340R, 0.1%, ±25ppm, 1/16W, 0402	MC004360	Resistor, Thin Film, 909R, 0.1%, ±25ppm, 1/16W, 0402	MC004401
Resistor, Thin Film, 348R, 0.1%, ±25ppm, 1/16W, 0402	MC004361	Resistor, Thin Film, 931R, 0.1%, ±25ppm, 1/16W, 0402	MC004402
Resistor, Thin Film, 357R, 0.1%, ±25ppm, 1/16W, 0402	MC004362	Resistor, Thin Film, 953R, 0.1%, ±25ppm, 1/16W, 0402	MC004403
Resistor, Thin Film, 365R, 0.1%, ±25ppm, 1/16W, 0402	MC004363	Resistor, Thin Film, 976R, 0.1%, ±25ppm, 1/16W, 0402	MC004404
Resistor, Thin Film, 374R, 0.1%, ±25ppm, 1/16W, 0402	MC004364	Resistor, Thin Film, 1K, 0.1%, ±25ppm, 1/16W, 0402	MC004405
Resistor, Thin Film, 383R, 0.1%, ±25ppm, 1/16W, 0402	MC004365	Resistor, Thin Film, 1K02, 0.1%, ±25ppm, 1/16W, 0402	MC004406
Resistor, Thin Film, 392R, 0.1%, ±25ppm, 1/16W, 0402	MC004366	Resistor, Thin Film, 1K05, 0.1%, ±25ppm, 1/16W, 0402	MC004407
Resistor, Thin Film, 402R, 0.1%, ±25ppm, 1/16W, 0402	MC004367	Resistor, Thin Film, 1K07, 0.1%, ±25ppm, 1/16W, 0402	MC004408
Resistor, Thin Film, 412R, 0.1%, ±25ppm, 1/16W, 0402	MC004368	Resistor, Thin Film, 1K1, 0.1%, ±25ppm, 1/16W, 0402	MC004409
Resistor, Thin Film, 422R, 0.1%, ±25ppm, 1/16W, 0402	MC004369	Resistor, Thin Film, 1K13, 0.1%, ±25ppm, 1/16W, 0402	MC004410
Resistor, Thin Film, 432R, 0.1%, ±25ppm, 1/16W, 0402	MC004370	Resistor, Thin Film, 1K15, 0.1%, ±25ppm, 1/16W, 0402	MC004411
Resistor, Thin Film, 442R, 0.1%, ±25ppm, 1/16W, 0402	MC004371	Resistor, Thin Film, 1K18, 0.1%, ±25ppm, 1/16W, 0402	MC004412
Resistor, Thin Film, 453R, 0.1%, ±25ppm, 1/16W, 0402	MC004372	Resistor, Thin Film, 1K21, 0.1%, ±25ppm, 1/16W, 0402	MC004413
Resistor, Thin Film, 464R, 0.1%, ±25ppm, 1/16W, 0402	MC004373	Resistor, Thin Film, 1K24, 0.1%, ±25ppm, 1/16W, 0402	MC004414
Resistor, Thin Film, 475R, 0.1%, ±25ppm, 1/16W, 0402	MC004374	Resistor, Thin Film, 1K27, 0.1%, ±25ppm, 1/16W, 0402	MC004415
Resistor, Thin Film, 487R, 0.1%, ±25ppm, 1/16W, 0402	MC004375	Resistor, Thin Film, 1K3, 0.1%, ±25ppm, 1/16W, 0402	MC004416
Resistor, Thin Film, 499R, 0.1%, ±25ppm, 1/16W, 0402	MC004376	Resistor, Thin Film, 1K33, 0.1%, ±25ppm, 1/16W, 0402	MC004417
Resistor, Thin Film, 511R, 0.1%, ±25ppm, 1/16W, 0402	MC004377	Resistor, Thin Film, 1K37, 0.1%, ±25ppm, 1/16W, 0402	MC004418
Resistor, Thin Film, 523R, 0.1%, ±25ppm, 1/16W, 0402	MC004378	Resistor, Thin Film, 1K4, 0.1%, ±25ppm, 1/16W, 0402	MC004419
Resistor, Thin Film, 536R, 0.1%, ±25ppm, 1/16W, 0402	MC004379	Resistor, Thin Film, 1K43, 0.1%, ±25ppm, 1/16W, 0402	MC004420
Resistor, Thin Film, 549R, 0.1%, ±25ppm, 1/16W, 0402	MC004380	Resistor, Thin Film, 1K47, 0.1%, ±25ppm, 1/16W, 0402	MC004421
Resistor, Thin Film, 562R, 0.1%, ±25ppm, 1/16W, 0402	MC004381	Resistor, Thin Film, 1K5, 0.1%, ±25ppm, 1/16W, 0402	MC004422
Resistor, Thin Film, 576R, 0.1%, ±25ppm, 1/16W, 0402	MC004382	Resistor, Thin Film, 1K54, 0.1%, ±25ppm, 1/16W, 0402	MC004423
Resistor, Thin Film, 590R, 0.1%, ±25ppm, 1/16W, 0402	MC004383	Resistor, Thin Film, 1K58, 0.1%, ±25ppm, 1/16W, 0402	MC004424
Resistor, Thin Film, 604R, 0.1%, ±25ppm, 1/16W, 0402	MC004384	Resistor, Thin Film, 1K62, 0.1%, ±25ppm, 1/16W, 0402	MC004425
Resistor, Thin Film, 619R, 0.1%, ±25ppm, 1/16W, 0402	MC004385	Resistor, Thin Film, 1K65, 0.1%, ±25ppm, 1/16W, 0402	MC004426
Resistor, Thin Film, 634R, 0.1%, ±25ppm, 1/16W, 0402	MC004386	Resistor, Thin Film, 1K69, 0.1%, ±25ppm, 1/16W, 0402	MC004427
Resistor, Thin Film, 649R, 0.1%, ±25ppm, 1/16W, 0402	MC004387	Resistor, Thin Film, 1K74, 0.1%, ±25ppm, 1/16W, 0402	MC004428

www.element14.com
www.farnell.com
www.newark.com



Thin Film Precision Chip Resistor

Description	Part Number	Description	Part Number
Resistor, Thin Film, 1K78, 0.1%, ±25ppm, 1/16W, 0402	MC004429	Resistor, Thin Film, 5K11, 0.1%, ±25ppm, 1/16W, 0402	MC004470
Resistor, Thin Film, 1K82, 0.1%, ±25ppm, 1/16W, 0402	MC004430	Resistor, Thin Film, 5K23, 0.1%, ±25ppm, 1/16W, 0402	MC004471
Resistor, Thin Film, 1K87, 0.1%, ±25ppm, 1/16W, 0402	MC004431	Resistor, Thin Film, 5K36, 0.1%, ±25ppm, 1/16W, 0402	MC004472
Resistor, Thin Film, 1K91, 0.1%, ±25ppm, 1/16W, 0402	MC004432	Resistor, Thin Film, 5K49, 0.1%, ±25ppm, 1/16W, 0402	MC004473
Resistor, Thin Film, 1K96, 0.1%, ±25ppm, 1/16W, 0402	MC004433	Resistor, Thin Film, 5K62, 0.1%, ±25ppm, 1/16W, 0402	MC004474
Resistor, Thin Film, 2K, 0.1%, ±25ppm, 1/16W, 0402	MC004434	Resistor, Thin Film, 5K76, 0.1%, ±25ppm, 1/16W, 0402	MC004475
Resistor, Thin Film, 2K05, 0.1%, ±25ppm, 1/16W, 0402	MC004435	Resistor, Thin Film, 5K9, 0.1%, ±25ppm, 1/16W, 0402	MC004476
Resistor, Thin Film, 2K1, 0.1%, ±25ppm, 1/16W, 0402	MC004436	Resistor, Thin Film, 6K04, 0.1%, ±25ppm, 1/16W, 0402	MC004477
Resistor, Thin Film, 2K15, 0.1%, ±25ppm, 1/16W, 0402	MC004437	Resistor, Thin Film, 6K19, 0.1%, ±25ppm, 1/16W, 0402	MC004478
Resistor, Thin Film, 2K21, 0.1%, ±25ppm, 1/16W, 0402	MC004438	Resistor, Thin Film, 6K34, 0.1%, ±25ppm, 1/16W, 0402	MC004479
Resistor, Thin Film, 2K26, 0.1%, ±25ppm, 1/16W, 0402	MC004439	Resistor, Thin Film, 6K49, 0.1%, ±25ppm, 1/16W, 0402	MC004480
Resistor, Thin Film, 2K32, 0.1%, ±25ppm, 1/16W, 0402	MC004440	Resistor, Thin Film, 6K65, 0.1%, ±25ppm, 1/16W, 0402	MC004481
Resistor, Thin Film, 2K37, 0.1%, ±25ppm, 1/16W, 0402	MC004441	Resistor, Thin Film, 6K81, 0.1%, ±25ppm, 1/16W, 0402	MC004482
Resistor, Thin Film, 2K43, 0.1%, ±25ppm, 1/16W, 0402	MC004442	Resistor, Thin Film, 6K98, 0.1%, ±25ppm, 1/16W, 0402	MC004483
Resistor, Thin Film, 2K49, 0.1%, ±25ppm, 1/16W, 0402	MC004443	Resistor, Thin Film, 7K15, 0.1%, ±25ppm, 1/16W, 0402	MC004484
Resistor, Thin Film, 2K55, 0.1%, ±25ppm, 1/16W, 0402	MC004444	Resistor, Thin Film, 7K32, 0.1%, ±25ppm, 1/16W, 0402	MC004485
Resistor, Thin Film, 2K61, 0.1%, ±25ppm, 1/16W, 0402	MC004445	Resistor, Thin Film, 7K5, 0.1%, ±25ppm, 1/16W, 0402	MC004486
Resistor, Thin Film, 2K67, 0.1%, ±25ppm, 1/16W, 0402	MC004446	Resistor, Thin Film, 7K68, 0.1%, ±25ppm, 1/16W, 0402	MC004487
Resistor, Thin Film, 2K74, 0.1%, ±25ppm, 1/16W, 0402	MC004447	Resistor, Thin Film, 7K87, 0.1%, ±25ppm, 1/16W, 0402	MC004488
Resistor, Thin Film, 2K8, 0.1%, ±25ppm, 1/16W, 0402	MC004448	Resistor, Thin Film, 8K06, 0.1%, ±25ppm, 1/16W, 0402	MC004489
Resistor, Thin Film, 2K94, 0.1%, ±25ppm, 1/16W, 0402	MC004449	Resistor, Thin Film, 8K25, 0.1%, ±25ppm, 1/16W, 0402	MC004490
Resistor, Thin Film, 3K16, 0.1%, ±25ppm, 1/16W, 0402	MC004450	Resistor, Thin Film, 8K45, 0.1%, ±25ppm, 1/16W, 0402	MC004491
Resistor, Thin Film, 3K24, 0.1%, ±25ppm, 1/16W, 0402	MC004451	Resistor, Thin Film, 8K66, 0.1%, ±25ppm, 1/16W, 0402	MC004492
Resistor, Thin Film, 3K32, 0.1%, ±25ppm, 1/16W, 0402	MC004452	Resistor, Thin Film, 8K87, 0.1%, ±25ppm, 1/16W, 0402	MC004493
Resistor, Thin Film, 3K4, 0.1%, ±25ppm, 1/16W, 0402	MC004453	Resistor, Thin Film, 9K09, 0.1%, ±25ppm, 1/16W, 0402	MC004494
Resistor, Thin Film, 3K48, 0.1%, ±25ppm, 1/16W, 0402	MC004454	Resistor, Thin Film, 9K31, 0.1%, ±25ppm, 1/16W, 0402	MC004495
Resistor, Thin Film, 3K57, 0.1%, ±25ppm, 1/16W, 0402	MC004455	Resistor, Thin Film, 9K53, 0.1%, ±25ppm, 1/16W, 0402	MC004496
Resistor, Thin Film, 3K65, 0.1%, ±25ppm, 1/16W, 0402	MC004456	Resistor, Thin Film, 9K76, 0.1%, ±25ppm, 1/16W, 0402	MC004497
Resistor, Thin Film, 3K74, 0.1%, ±25ppm, 1/16W, 0402	MC004457	Resistor, Thin Film, 10K, 0.1%, ±25ppm, 1/16W, 0402	MC004498
Resistor, Thin Film, 3K83, 0.1%, ±25ppm, 1/16W, 0402	MC004458	Resistor, Thin Film, 10K2, 0.1%, ±25ppm, 1/16W, 0402	MC004499
Resistor, Thin Film, 3K92, 0.1%, ±25ppm, 1/16W, 0402	MC004459	Resistor, Thin Film, 10K5, 0.1%, ±25ppm, 1/16W, 0402	MC004500
Resistor, Thin Film, 4K02, 0.1%, ±25ppm, 1/16W, 0402	MC004460	Resistor, Thin Film, 10K7, 0.1%, ±25ppm, 1/16W, 0402	MC004501
Resistor, Thin Film, 4K12, 0.1%, ±25ppm, 1/16W, 0402	MC004461	Resistor, Thin Film, 11K, 0.1%, ±25ppm, 1/16W, 0402	MC004502
Resistor, Thin Film, 4K22, 0.1%, ±25ppm, 1/16W, 0402	MC004462	Resistor, Thin Film, 11K3, 0.1%, ±25ppm, 1/16W, 0402	MC004503
Resistor, Thin Film, 4K32, 0.1%, ±25ppm, 1/16W, 0402	MC004463	Resistor, Thin Film, 11K5, 0.1%, ±25ppm, 1/16W, 0402	MC004504
Resistor, Thin Film, 4K42, 0.1%, ±25ppm, 1/16W, 0402	MC004464	Resistor, Thin Film, 11K8, 0.1%, ±25ppm, 1/16W, 0402	MC004505
Resistor, Thin Film, 4K53, 0.1%, ±25ppm, 1/16W, 0402	MC004465	Resistor, Thin Film, 12K1, 0.1%, ±25ppm, 1/16W, 0402	MC004506
Resistor, Thin Film, 4K64, 0.1%, ±25ppm, 1/16W, 0402	MC004466	Resistor, Thin Film, 12K4, 0.1%, ±25ppm, 1/16W, 0402	MC004507
Resistor, Thin Film, 4K75, 0.1%, ±25ppm, 1/16W, 0402	MC004467	Resistor, Thin Film, 12K7, 0.1%, ±25ppm, 1/16W, 0402	MC004508
Resistor, Thin Film, 4K87, 0.1%, ±25ppm, 1/16W, 0402	MC004468	Resistor, Thin Film, 13K, 0.1%, ±25ppm, 1/16W, 0402	MC004509
Resistor, Thin Film, 4K99, 0.1%, ±25ppm, 1/16W, 0402	MC004469	Resistor, Thin Film, 13K3, 0.1%, ±25ppm, 1/16W, 0402	MC004510

www.element14.com
www.farnell.com
www.newark.com



Thin Film Precision Chip Resistor

Description	Part Number	Description	Part Number
Resistor, Thin Film, 13K7, 0.1%, ± 25 ppm, 1/16W, 0402	MC004511	Resistor, Thin Film, 39K2, 0.1%, ± 25 ppm, 1/16W, 0402	MC004552
Resistor, Thin Film, 14K, 0.1%, ± 25 ppm, 1/16W, 0402	MC004512	Resistor, Thin Film, 40K2, 0.1%, ± 25 ppm, 1/16W, 0402	MC004553
Resistor, Thin Film, 14K3, 0.1%, ± 25 ppm, 1/16W, 0402	MC004513	Resistor, Thin Film, 41K2, 0.1%, ± 25 ppm, 1/16W, 0402	MC004554
Resistor, Thin Film, 14K7, 0.1%, ± 25 ppm, 1/16W, 0402	MC004514	Resistor, Thin Film, 42K2, 0.1%, ± 25 ppm, 1/16W, 0402	MC004555
Resistor, Thin Film, 15K, 0.1%, ± 25 ppm, 1/16W, 0402	MC004515	Resistor, Thin Film, 43K2, 0.1%, ± 25 ppm, 1/16W, 0402	MC004556
Resistor, Thin Film, 15K4, 0.1%, ± 25 ppm, 1/16W, 0402	MC004516	Resistor, Thin Film, 44K2, 0.1%, ± 25 ppm, 1/16W, 0402	MC004557
Resistor, Thin Film, 15K8, 0.1%, ± 25 ppm, 1/16W, 0402	MC004517	Resistor, Thin Film, 45K3, 0.1%, ± 25 ppm, 1/16W, 0402	MC004558
Resistor, Thin Film, 16K2, 0.1%, ± 25 ppm, 1/16W, 0402	MC004518	Resistor, Thin Film, 46K4, 0.1%, ± 25 ppm, 1/16W, 0402	MC004559
Resistor, Thin Film, 16K5, 0.1%, ± 25 ppm, 1/16W, 0402	MC004519	Resistor, Thin Film, 47K5, 0.1%, ± 25 ppm, 1/16W, 0402	MC004560
Resistor, Thin Film, 16K9, 0.1%, ± 25 ppm, 1/16W, 0402	MC004520	Resistor, Thin Film, 48K7, 0.1%, ± 25 ppm, 1/16W, 0402	MC004561
Resistor, Thin Film, 17K4, 0.1%, ± 25 ppm, 1/16W, 0402	MC004521	Resistor, Thin Film, 49K9, 0.1%, ± 25 ppm, 1/16W, 0402	MC004562
Resistor, Thin Film, 17K8, 0.1%, ± 25 ppm, 1/16W, 0402	MC004522	Resistor, Thin Film, 51K1, 0.1%, ± 25 ppm, 1/16W, 0402	MC004563
Resistor, Thin Film, 18K2, 0.1%, ± 25 ppm, 1/16W, 0402	MC004523	Resistor, Thin Film, 52K3, 0.1%, ± 25 ppm, 1/16W, 0402	MC004564
Resistor, Thin Film, 18K7, 0.1%, ± 25 ppm, 1/16W, 0402	MC004524	Resistor, Thin Film, 53K6, 0.1%, ± 25 ppm, 1/16W, 0402	MC004565
Resistor, Thin Film, 19K1, 0.1%, ± 25 ppm, 1/16W, 0402	MC004525	Resistor, Thin Film, 54K9, 0.1%, ± 25 ppm, 1/16W, 0402	MC004566
Resistor, Thin Film, 19K6, 0.1%, ± 25 ppm, 1/16W, 0402	MC004526	Resistor, Thin Film, 56K2, 0.1%, ± 25 ppm, 1/16W, 0402	MC004567
Resistor, Thin Film, 20K, 0.1%, ± 25 ppm, 1/16W, 0402	MC004527	Resistor, Thin Film, 57K6, 0.1%, ± 25 ppm, 1/16W, 0402	MC004568
Resistor, Thin Film, 20K5, 0.1%, ± 25 ppm, 1/16W, 0402	MC004528	Resistor, Thin Film, 59K, 0.1%, ± 25 ppm, 1/16W, 0402	MC004569
Resistor, Thin Film, 21K, 0.1%, ± 25 ppm, 1/16W, 0402	MC004529	Resistor, Thin Film, 60K4, 0.1%, ± 25 ppm, 1/16W, 0402	MC004570
Resistor, Thin Film, 21K5, 0.1%, ± 25 ppm, 1/16W, 0402	MC004530	Resistor, Thin Film, 61K9, 0.1%, ± 25 ppm, 1/16W, 0402	MC004571
Resistor, Thin Film, 22K1, 0.1%, ± 25 ppm, 1/16W, 0402	MC004531	Resistor, Thin Film, 63K4, 0.1%, ± 25 ppm, 1/16W, 0402	MC004572
Resistor, Thin Film, 22K6, 0.1%, ± 25 ppm, 1/16W, 0402	MC004532	Resistor, Thin Film, 64K9, 0.1%, ± 25 ppm, 1/16W, 0402	MC004573
Resistor, Thin Film, 23K2, 0.1%, ± 25 ppm, 1/16W, 0402	MC004533	Resistor, Thin Film, 66K5, 0.1%, ± 25 ppm, 1/16W, 0402	MC004574
Resistor, Thin Film, 23K7, 0.1%, ± 25 ppm, 1/16W, 0402	MC004534	Resistor, Thin Film, 68K1, 0.1%, ± 25 ppm, 1/16W, 0402	MC004575
Resistor, Thin Film, 24K3, 0.1%, ± 25 ppm, 1/16W, 0402	MC004535	Resistor, Thin Film, 69K8, 0.1%, ± 25 ppm, 1/16W, 0402	MC004576
Resistor, Thin Film, 24K9, 0.1%, ± 25 ppm, 1/16W, 0402	MC004536	Resistor, Thin Film, 71K5, 0.1%, ± 25 ppm, 1/16W, 0402	MC004577
Resistor, Thin Film, 25K5, 0.1%, ± 25 ppm, 1/16W, 0402	MC004537	Resistor, Thin Film, 73K2, 0.1%, ± 25 ppm, 1/16W, 0402	MC004578
Resistor, Thin Film, 26K1, 0.1%, ± 25 ppm, 1/16W, 0402	MC004538	Resistor, Thin Film, 75K, 0.1%, ± 25 ppm, 1/16W, 0402	MC004579
Resistor, Thin Film, 26K7, 0.1%, ± 25 ppm, 1/16W, 0402	MC004539	Resistor, Thin Film, 76K8, 0.1%, ± 25 ppm, 1/16W, 0402	MC004580
Resistor, Thin Film, 27K4, 0.1%, ± 25 ppm, 1/16W, 0402	MC004540	Resistor, Thin Film, 78K7, 0.1%, ± 25 ppm, 1/16W, 0402	MC004581
Resistor, Thin Film, 28K, 0.1%, ± 25 ppm, 1/16W, 0402	MC004541	Resistor, Thin Film, 80K6, 0.1%, ± 25 ppm, 1/16W, 0402	MC004582
Resistor, Thin Film, 29K4, 0.1%, ± 25 ppm, 1/16W, 0402	MC004542	Resistor, Thin Film, 82K5, 0.1%, ± 25 ppm, 1/16W, 0402	MC004583
Resistor, Thin Film, 31K6, 0.1%, ± 25 ppm, 1/16W, 0402	MC004543	Resistor, Thin Film, 84K5, 0.1%, ± 25 ppm, 1/16W, 0402	MC004584
Resistor, Thin Film, 32K4, 0.1%, ± 25 ppm, 1/16W, 0402	MC004544	Resistor, Thin Film, 86K6, 0.1%, ± 25 ppm, 1/16W, 0402	MC004585
Resistor, Thin Film, 33K2, 0.1%, ± 25 ppm, 1/16W, 0402	MC004545	Resistor, Thin Film, 88K7, 0.1%, ± 25 ppm, 1/16W, 0402	MC004586
Resistor, Thin Film, 34K, 0.1%, ± 25 ppm, 1/16W, 0402	MC004546	Resistor, Thin Film, 90K9, 0.1%, ± 25 ppm, 1/16W, 0402	MC004587
Resistor, Thin Film, 34K8, 0.1%, ± 25 ppm, 1/16W, 0402	MC004547	Resistor, Thin Film, 93K1, 0.1%, ± 25 ppm, 1/16W, 0402	MC004588
Resistor, Thin Film, 35K7, 0.1%, ± 25 ppm, 1/16W, 0402	MC004548	Resistor, Thin Film, 95K3, 0.1%, ± 25 ppm, 1/16W, 0402	MC004589
Resistor, Thin Film, 36K5, 0.1%, ± 25 ppm, 1/16W, 0402	MC004549	Resistor, Thin Film, 97K6, 0.1%, ± 25 ppm, 1/16W, 0402	MC004590
Resistor, Thin Film, 37K4, 0.1%, ± 25 ppm, 1/16W, 0402	MC004550	Resistor, Thin Film, 100K, 0.1%, ± 25 ppm, 1/16W, 0402	MC004591
Resistor, Thin Film, 38K3, 0.1%, ± 25 ppm, 1/16W, 0402	MC004551	Resistor, Thin Film, 102K, 0.1%, ± 25 ppm, 1/16W, 0402	MC004592

www.element14.com
www.farnell.com
www.newark.com



Thin Film Precision Chip Resistor

Description	Part Number	Description	Part Number
Resistor, Thin Film, 105K, 0.1%, ±25ppm, 1/16W, 0402	MC004593	Resistor, Thin Film, 280K, 0.1%, ±25ppm, 1/16W, 0402	MC004634
Resistor, Thin Film, 107K, 0.1%, ±25ppm, 1/16W, 0402	MC004594	Resistor, Thin Film, 294K, 0.1%, ±25ppm, 1/16W, 0402	MC004635
Resistor, Thin Film, 110K, 0.1%, ±25ppm, 1/16W, 0402	MC004595	Resistor, Thin Film, 316K, 0.1%, ±25ppm, 1/16W, 0402	MC004636
Resistor, Thin Film, 113K, 0.1%, ±25ppm, 1/16W, 0402	MC004596	Resistor, Thin Film, 324K, 0.1%, ±25ppm, 1/16W, 0402	MC004637
Resistor, Thin Film, 115K, 0.1%, ±25ppm, 1/16W, 0402	MC004597	Resistor, Thin Film, 332K, 0.1%, ±25ppm, 1/16W, 0402	MC004638
Resistor, Thin Film, 118K, 0.1%, ±25ppm, 1/16W, 0402	MC004598	Resistor, Thin Film, 340K, 0.1%, ±25ppm, 1/16W, 0402	MC004639
Resistor, Thin Film, 121K, 0.1%, ±25ppm, 1/16W, 0402	MC004599	Resistor, Thin Film, 348K, 0.1%, ±25ppm, 1/16W, 0402	MC004640
Resistor, Thin Film, 124K, 0.1%, ±25ppm, 1/16W, 0402	MC004600	Resistor, Thin Film, 357K, 0.1%, ±25ppm, 1/16W, 0402	MC004641
Resistor, Thin Film, 127K, 0.1%, ±25ppm, 1/16W, 0402	MC004601	Resistor, Thin Film, 365K, 0.1%, ±25ppm, 1/16W, 0402	MC004642
Resistor, Thin Film, 130K, 0.1%, ±25ppm, 1/16W, 0402	MC004602	Resistor, Thin Film, 374K, 0.1%, ±25ppm, 1/16W, 0402	MC004643
Resistor, Thin Film, 133K, 0.1%, ±25ppm, 1/16W, 0402	MC004603	Resistor, Thin Film, 383K, 0.1%, ±25ppm, 1/16W, 0402	MC004644
Resistor, Thin Film, 137K, 0.1%, ±25ppm, 1/16W, 0402	MC004604	Resistor, Thin Film, 392K, 0.1%, ±25ppm, 1/16W, 0402	MC004645
Resistor, Thin Film, 140K, 0.1%, ±25ppm, 1/16W, 0402	MC004605	Resistor, Thin Film, 402K, 0.1%, ±25ppm, 1/16W, 0402	MC004646
Resistor, Thin Film, 143K, 0.1%, ±25ppm, 1/16W, 0402	MC004606	Resistor, Thin Film, 412K, 0.1%, ±25ppm, 1/16W, 0402	MC004647
Resistor, Thin Film, 147K, 0.1%, ±25ppm, 1/16W, 0402	MC004607	Resistor, Thin Film, 422K, 0.1%, ±25ppm, 1/16W, 0402	MC004648
Resistor, Thin Film, 150K, 0.1%, ±25ppm, 1/16W, 0402	MC004608	Resistor, Thin Film, 432K, 0.1%, ±25ppm, 1/16W, 0402	MC004649
Resistor, Thin Film, 154K, 0.1%, ±25ppm, 1/16W, 0402	MC004609	Resistor, Thin Film, 442K, 0.1%, ±25ppm, 1/16W, 0402	MC004650
Resistor, Thin Film, 158K, 0.1%, ±25ppm, 1/16W, 0402	MC004610	Resistor, Thin Film, 453K, 0.1%, ±25ppm, 1/16W, 0402	MC004651
Resistor, Thin Film, 162K, 0.1%, ±25ppm, 1/16W, 0402	MC004611	Resistor, Thin Film, 464K, 0.1%, ±25ppm, 1/16W, 0402	MC004652
Resistor, Thin Film, 165K, 0.1%, ±25ppm, 1/16W, 0402	MC004612	Resistor, Thin Film, 475K, 0.1%, ±25ppm, 1/16W, 0402	MC004653
Resistor, Thin Film, 169K, 0.1%, ±25ppm, 1/16W, 0402	MC004613	Resistor, Thin Film, 487K, 0.1%, ±25ppm, 1/16W, 0402	MC004654
Resistor, Thin Film, 174K, 0.1%, ±25ppm, 1/16W, 0402	MC004614	Resistor, Thin Film, 499K, 0.1%, ±25ppm, 1/16W, 0402	MC004655
Resistor, Thin Film, 178K, 0.1%, ±25ppm, 1/16W, 0402	MC004615	Resistor, Thin Film, 511K, 0.1%, ±25ppm, 1/16W, 0402	MC004656
Resistor, Thin Film, 182K, 0.1%, ±25ppm, 1/16W, 0402	MC004616	Resistor, Thin Film, 4R7, 0.1%, ±25ppm, 1/16W, 0603	MC004657
Resistor, Thin Film, 187K, 0.1%, ±25ppm, 1/16W, 0402	MC004617	Resistor, Thin Film, 5R1, 0.1%, ±25ppm, 1/16W, 0603	MC004658
Resistor, Thin Film, 191K, 0.1%, ±25ppm, 1/16W, 0402	MC004618	Resistor, Thin Film, 5R6, 0.1%, ±25ppm, 1/16W, 0603	MC004659
Resistor, Thin Film, 196K, 0.1%, ±25ppm, 1/16W, 0402	MC004619	Resistor, Thin Film, 6R2, 0.1%, ±25ppm, 1/16W, 0603	MC004660
Resistor, Thin Film, 200K, 0.1%, ±25ppm, 1/16W, 0402	MC004620	Resistor, Thin Film, 6R8, 0.1%, ±25ppm, 1/16W, 0603	MC004661
Resistor, Thin Film, 205K, 0.1%, ±25ppm, 1/16W, 0402	MC004621	Resistor, Thin Film, 7R5, 0.1%, ±25ppm, 1/16W, 0603	MC004662
Resistor, Thin Film, 210K, 0.1%, ±25ppm, 1/16W, 0402	MC004622	Resistor, Thin Film, 8R2, 0.1%, ±25ppm, 1/16W, 0603	MC004663
Resistor, Thin Film, 215K, 0.1%, ±25ppm, 1/16W, 0402	MC004623	Resistor, Thin Film, 9R1, 0.1%, ±25ppm, 1/16W, 0603	MC004664
Resistor, Thin Film, 221K, 0.1%, ±25ppm, 1/16W, 0402	MC004624	Resistor, Thin Film, 10R, 0.1%, ±25ppm, 1/16W, 0603	MC004665
Resistor, Thin Film, 226K, 0.1%, ±25ppm, 1/16W, 0402	MC004625	Resistor, Thin Film, 10R2, 0.1%, ±25ppm, 1/16W, 0603	MC004666
Resistor, Thin Film, 232K, 0.1%, ±25ppm, 1/16W, 0402	MC004626	Resistor, Thin Film, 10R5, 0.1%, ±25ppm, 1/16W, 0603	MC004667
Resistor, Thin Film, 237K, 0.1%, ±25ppm, 1/16W, 0402	MC004627	Resistor, Thin Film, 10R7, 0.1%, ±25ppm, 1/16W, 0603	MC004668
Resistor, Thin Film, 243K, 0.1%, ±25ppm, 1/16W, 0402	MC004628	Resistor, Thin Film, 11R, 0.1%, ±25ppm, 1/16W, 0603	MC004669
Resistor, Thin Film, 249K, 0.1%, ±25ppm, 1/16W, 0402	MC004629	Resistor, Thin Film, 11R3, 0.1%, ±25ppm, 1/16W, 0603	MC004670
Resistor, Thin Film, 255K, 0.1%, ±25ppm, 1/16W, 0402	MC004630	Resistor, Thin Film, 11R5, 0.1%, ±25ppm, 1/16W, 0603	MC004671
Resistor, Thin Film, 261K, 0.1%, ±25ppm, 1/16W, 0402	MC004631	Resistor, Thin Film, 11R8, 0.1%, ±25ppm, 1/16W, 0603	MC004672
Resistor, Thin Film, 267K, 0.1%, ±25ppm, 1/16W, 0402	MC004632	Resistor, Thin Film, 12R1, 0.1%, ±25ppm, 1/16W, 0603	MC004673
Resistor, Thin Film, 274K, 0.1%, ±25ppm, 1/16W, 0402	MC004633	Resistor, Thin Film, 12R4, 0.1%, ±25ppm, 1/16W, 0603	MC004674

www.element14.com
www.farnell.com
www.newark.com



Thin Film Precision Chip Resistor

Description	Part Number	Description	Part Number
Resistor, Thin Film, 12R7, 0.1%, ±25ppm, 1/16W, 0603	MC004675	Resistor, Thin Film, 36R5, 0.1%, ±25ppm, 1/16W, 0603	MC004716
Resistor, Thin Film, 13R, 0.1%, ±25ppm, 1/16W, 0603	MC004676	Resistor, Thin Film, 37R4, 0.1%, ±25ppm, 1/16W, 0603	MC004717
Resistor, Thin Film, 13R3, 0.1%, ±25ppm, 1/16W, 0603	MC004677	Resistor, Thin Film, 38R3, 0.1%, ±25ppm, 1/16W, 0603	MC004718
Resistor, Thin Film, 13R7, 0.1%, ±25ppm, 1/16W, 0603	MC004678	Resistor, Thin Film, 39R2, 0.1%, ±25ppm, 1/16W, 0603	MC004719
Resistor, Thin Film, 14R, 0.1%, ±25ppm, 1/16W, 0603	MC004679	Resistor, Thin Film, 40R2, 0.1%, ±25ppm, 1/16W, 0603	MC004720
Resistor, Thin Film, 14R3, 0.1%, ±25ppm, 1/16W, 0603	MC004680	Resistor, Thin Film, 41R2, 0.1%, ±25ppm, 1/16W, 0603	MC004721
Resistor, Thin Film, 14R7, 0.1%, ±25ppm, 1/16W, 0603	MC004681	Resistor, Thin Film, 42R2, 0.1%, ±25ppm, 1/16W, 0603	MC004722
Resistor, Thin Film, 15R, 0.1%, ±25ppm, 1/16W, 0603	MC004682	Resistor, Thin Film, 43R2, 0.1%, ±25ppm, 1/16W, 0603	MC004723
Resistor, Thin Film, 15R4, 0.1%, ±25ppm, 1/16W, 0603	MC004683	Resistor, Thin Film, 44R2, 0.1%, ±25ppm, 1/16W, 0603	MC004724
Resistor, Thin Film, 15R8, 0.1%, ±25ppm, 1/16W, 0603	MC004684	Resistor, Thin Film, 45R3, 0.1%, ±25ppm, 1/16W, 0603	MC004725
Resistor, Thin Film, 16R2, 0.1%, ±25ppm, 1/16W, 0603	MC004685	Resistor, Thin Film, 46R4, 0.1%, ±25ppm, 1/16W, 0603	MC004726
Resistor, Thin Film, 16R5, 0.1%, ±25ppm, 1/16W, 0603	MC004686	Resistor, Thin Film, 47R5, 0.1%, ±25ppm, 1/16W, 0603	MC004727
Resistor, Thin Film, 16R9, 0.1%, ±25ppm, 1/16W, 0603	MC004687	Resistor, Thin Film, 48R7, 0.1%, ±25ppm, 1/16W, 0603	MC004728
Resistor, Thin Film, 17R4, 0.1%, ±25ppm, 1/16W, 0603	MC004688	Resistor, Thin Film, 49R9, 0.1%, ±25ppm, 1/16W, 0603	MC004729
Resistor, Thin Film, 17R8, 0.1%, ±25ppm, 1/16W, 0603	MC004689	Resistor, Thin Film, 51R1, 0.1%, ±25ppm, 1/16W, 0603	MC004730
Resistor, Thin Film, 18R2, 0.1%, ±25ppm, 1/16W, 0603	MC004690	Resistor, Thin Film, 52R3, 0.1%, ±25ppm, 1/16W, 0603	MC004731
Resistor, Thin Film, 18R7, 0.1%, ±25ppm, 1/16W, 0603	MC004691	Resistor, Thin Film, 53R6, 0.1%, ±25ppm, 1/16W, 0603	MC004732
Resistor, Thin Film, 19R1, 0.1%, ±25ppm, 1/16W, 0603	MC004692	Resistor, Thin Film, 54R9, 0.1%, ±25ppm, 1/16W, 0603	MC004733
Resistor, Thin Film, 19R6, 0.1%, ±25ppm, 1/16W, 0603	MC004693	Resistor, Thin Film, 56R2, 0.1%, ±25ppm, 1/16W, 0603	MC004734
Resistor, Thin Film, 20R, 0.1%, ±25ppm, 1/16W, 0603	MC004694	Resistor, Thin Film, 57R6, 0.1%, ±25ppm, 1/16W, 0603	MC004735
Resistor, Thin Film, 20R5, 0.1%, ±25ppm, 1/16W, 0603	MC004695	Resistor, Thin Film, 59R, 0.1%, ±25ppm, 1/16W, 0603	MC004736
Resistor, Thin Film, 21R, 0.1%, ±25ppm, 1/16W, 0603	MC004696	Resistor, Thin Film, 60R4, 0.1%, ±25ppm, 1/16W, 0603	MC004737
Resistor, Thin Film, 21R5, 0.1%, ±25ppm, 1/16W, 0603	MC004697	Resistor, Thin Film, 61R9, 0.1%, ±25ppm, 1/16W, 0603	MC004738
Resistor, Thin Film, 22R1, 0.1%, ±25ppm, 1/16W, 0603	MC004698	Resistor, Thin Film, 63R4, 0.1%, ±25ppm, 1/16W, 0603	MC004739
Resistor, Thin Film, 22R6, 0.1%, ±25ppm, 1/16W, 0603	MC004699	Resistor, Thin Film, 64R9, 0.1%, ±25ppm, 1/16W, 0603	MC004740
Resistor, Thin Film, 23R2, 0.1%, ±25ppm, 1/16W, 0603	MC004700	Resistor, Thin Film, 66R5, 0.1%, ±25ppm, 1/16W, 0603	MC004741
Resistor, Thin Film, 23R7, 0.1%, ±25ppm, 1/16W, 0603	MC004701	Resistor, Thin Film, 68R1, 0.1%, ±25ppm, 1/16W, 0603	MC004742
Resistor, Thin Film, 24R3, 0.1%, ±25ppm, 1/16W, 0603	MC004702	Resistor, Thin Film, 69R8, 0.1%, ±25ppm, 1/16W, 0603	MC004743
Resistor, Thin Film, 24R9, 0.1%, ±25ppm, 1/16W, 0603	MC004703	Resistor, Thin Film, 71R5, 0.1%, ±25ppm, 1/16W, 0603	MC004744
Resistor, Thin Film, 25R5, 0.1%, ±25ppm, 1/16W, 0603	MC004704	Resistor, Thin Film, 73R2, 0.1%, ±25ppm, 1/16W, 0603	MC004745
Resistor, Thin Film, 26R1, 0.1%, ±25ppm, 1/16W, 0603	MC004705	Resistor, Thin Film, 75R, 0.1%, ±25ppm, 1/16W, 0603	MC004746
Resistor, Thin Film, 26R7, 0.1%, ±25ppm, 1/16W, 0603	MC004706	Resistor, Thin Film, 76R8, 0.1%, ±25ppm, 1/16W, 0603	MC004747
Resistor, Thin Film, 27R4, 0.1%, ±25ppm, 1/16W, 0603	MC004707	Resistor, Thin Film, 78R7, 0.1%, ±25ppm, 1/16W, 0603	MC004748
Resistor, Thin Film, 28R, 0.1%, ±25ppm, 1/16W, 0603	MC004708	Resistor, Thin Film, 80R6, 0.1%, ±25ppm, 1/16W, 0603	MC004749
Resistor, Thin Film, 29R4, 0.1%, ±25ppm, 1/16W, 0603	MC004709	Resistor, Thin Film, 82R5, 0.1%, ±25ppm, 1/16W, 0603	MC004750
Resistor, Thin Film, 31R6, 0.1%, ±25ppm, 1/16W, 0603	MC004710	Resistor, Thin Film, 84R5, 0.1%, ±25ppm, 1/16W, 0603	MC004751
Resistor, Thin Film, 32R4, 0.1%, ±25ppm, 1/16W, 0603	MC004711	Resistor, Thin Film, 86R6, 0.1%, ±25ppm, 1/16W, 0603	MC004752
Resistor, Thin Film, 33R2, 0.1%, ±25ppm, 1/16W, 0603	MC004712	Resistor, Thin Film, 88R7, 0.1%, ±25ppm, 1/16W, 0603	MC004753
Resistor, Thin Film, 34R, 0.1%, ±25ppm, 1/16W, 0603	MC004713	Resistor, Thin Film, 90R9, 0.1%, ±25ppm, 1/16W, 0603	MC004754
Resistor, Thin Film, 34R8, 0.1%, ±25ppm, 1/16W, 0603	MC004714	Resistor, Thin Film, 93R1, 0.1%, ±25ppm, 1/16W, 0603	MC004755
Resistor, Thin Film, 35R7, 0.1%, ±25ppm, 1/16W, 0603	MC004715	Resistor, Thin Film, 95R3, 0.1%, ±25ppm, 1/16W, 0603	MC004756

www.element14.com
www.farnell.com
www.newark.com



Thin Film Precision Chip Resistor

Description	Part Number	Description	Part Number
Resistor, Thin Film, 97R6, 0.1%, ±25ppm, 1/16W, 0603	MC004757	Resistor, Thin Film, 665R, 0.1%, ±25ppm, 1/16W, 0603	MC004834
Resistor, Thin Film, 237R, 0.1%, ±25ppm, 1/16W, 0603	MC004794	Resistor, Thin Film, 681R, 0.1%, ±25ppm, 1/16W, 0603	MC004835
Resistor, Thin Film, 243R, 0.1%, ±25ppm, 1/16W, 0603	MC004795	Resistor, Thin Film, 698R, 0.1%, ±25ppm, 1/16W, 0603	MC004836
Resistor, Thin Film, 249R, 0.1%, ±25ppm, 1/16W, 0603	MC004796	Resistor, Thin Film, 715R, 0.1%, ±25ppm, 1/16W, 0603	MC004837
Resistor, Thin Film, 255R, 0.1%, ±25ppm, 1/16W, 0603	MC004797	Resistor, Thin Film, 732R, 0.1%, ±25ppm, 1/16W, 0603	MC004838
Resistor, Thin Film, 261R, 0.1%, ±25ppm, 1/16W, 0603	MC004798	Resistor, Thin Film, 750R, 0.1%, ±25ppm, 1/16W, 0603	MC004839
Resistor, Thin Film, 267R, 0.1%, ±25ppm, 1/16W, 0603	MC004799	Resistor, Thin Film, 768R, 0.1%, ±25ppm, 1/16W, 0603	MC004840
Resistor, Thin Film, 274R, 0.1%, ±25ppm, 1/16W, 0603	MC004800	Resistor, Thin Film, 787R, 0.1%, ±25ppm, 1/16W, 0603	MC004841
Resistor, Thin Film, 280R, 0.1%, ±25ppm, 1/16W, 0603	MC004801	Resistor, Thin Film, 806R, 0.1%, ±25ppm, 1/16W, 0603	MC004842
Resistor, Thin Film, 294R, 0.1%, ±25ppm, 1/16W, 0603	MC004802	Resistor, Thin Film, 825R, 0.1%, ±25ppm, 1/16W, 0603	MC004843
Resistor, Thin Film, 316R, 0.1%, ±25ppm, 1/16W, 0603	MC004803	Resistor, Thin Film, 845R, 0.1%, ±25ppm, 1/16W, 0603	MC004844
Resistor, Thin Film, 324R, 0.1%, ±25ppm, 1/16W, 0603	MC004804	Resistor, Thin Film, 866R, 0.1%, ±25ppm, 1/16W, 0603	MC004845
Resistor, Thin Film, 332R, 0.1%, ±25ppm, 1/16W, 0603	MC004805	Resistor, Thin Film, 887R, 0.1%, ±25ppm, 1/16W, 0603	MC004846
Resistor, Thin Film, 340R, 0.1%, ±25ppm, 1/16W, 0603	MC004806	Resistor, Thin Film, 909R, 0.1%, ±25ppm, 1/16W, 0603	MC004847
Resistor, Thin Film, 348R, 0.1%, ±25ppm, 1/16W, 0603	MC004807	Resistor, Thin Film, 931R, 0.1%, ±25ppm, 1/16W, 0603	MC004848
Resistor, Thin Film, 357R, 0.1%, ±25ppm, 1/16W, 0603	MC004808	Resistor, Thin Film, 953R, 0.1%, ±25ppm, 1/16W, 0603	MC004849
Resistor, Thin Film, 365R, 0.1%, ±25ppm, 1/16W, 0603	MC004809	Resistor, Thin Film, 976R, 0.1%, ±25ppm, 1/16W, 0603	MC004850
Resistor, Thin Film, 374R, 0.1%, ±25ppm, 1/16W, 0603	MC004810	Resistor, Thin Film, 1K02, 0.1%, ±25ppm, 1/16W, 0603	MC004852
Resistor, Thin Film, 383R, 0.1%, ±25ppm, 1/16W, 0603	MC004811	Resistor, Thin Film, 1K05, 0.1%, ±25ppm, 1/16W, 0603	MC004853
Resistor, Thin Film, 392R, 0.1%, ±25ppm, 1/16W, 0603	MC004812	Resistor, Thin Film, 1K07, 0.1%, ±25ppm, 1/16W, 0603	MC004854
Resistor, Thin Film, 402R, 0.1%, ±25ppm, 1/16W, 0603	MC004813	Resistor, Thin Film, 1K1, 0.1%, ±25ppm, 1/16W, 0603	MC004855
Resistor, Thin Film, 412R, 0.1%, ±25ppm, 1/16W, 0603	MC004814	Resistor, Thin Film, 1K13, 0.1%, ±25ppm, 1/16W, 0603	MC004856
Resistor, Thin Film, 422R, 0.1%, ±25ppm, 1/16W, 0603	MC004815	Resistor, Thin Film, 1K15, 0.1%, ±25ppm, 1/16W, 0603	MC004857
Resistor, Thin Film, 432R, 0.1%, ±25ppm, 1/16W, 0603	MC004816	Resistor, Thin Film, 1K18, 0.1%, ±25ppm, 1/16W, 0603	MC004858
Resistor, Thin Film, 442R, 0.1%, ±25ppm, 1/16W, 0603	MC004817	Resistor, Thin Film, 1K21, 0.1%, ±25ppm, 1/16W, 0603	MC004859
Resistor, Thin Film, 453R, 0.1%, ±25ppm, 1/16W, 0603	MC004818	Resistor, Thin Film, 1K24, 0.1%, ±25ppm, 1/16W, 0603	MC004860
Resistor, Thin Film, 464R, 0.1%, ±25ppm, 1/16W, 0603	MC004819	Resistor, Thin Film, 1K27, 0.1%, ±25ppm, 1/16W, 0603	MC004861
Resistor, Thin Film, 475R, 0.1%, ±25ppm, 1/16W, 0603	MC004820	Resistor, Thin Film, 1K3, 0.1%, ±25ppm, 1/16W, 0603	MC004862
Resistor, Thin Film, 487R, 0.1%, ±25ppm, 1/16W, 0603	MC004821	Resistor, Thin Film, 1K33, 0.1%, ±25ppm, 1/16W, 0603	MC004863
Resistor, Thin Film, 499R, 0.1%, ±25ppm, 1/16W, 0603	MC004822	Resistor, Thin Film, 1K37, 0.1%, ±25ppm, 1/16W, 0603	MC004864
Resistor, Thin Film, 511R, 0.1%, ±25ppm, 1/16W, 0603	MC004823	Resistor, Thin Film, 1K4, 0.1%, ±25ppm, 1/16W, 0603	MC004865
Resistor, Thin Film, 523R, 0.1%, ±25ppm, 1/16W, 0603	MC004824	Resistor, Thin Film, 1K43, 0.1%, ±25ppm, 1/16W, 0603	MC004866
Resistor, Thin Film, 536R, 0.1%, ±25ppm, 1/16W, 0603	MC004825	Resistor, Thin Film, 1K47, 0.1%, ±25ppm, 1/16W, 0603	MC004867
Resistor, Thin Film, 549R, 0.1%, ±25ppm, 1/16W, 0603	MC004826	Resistor, Thin Film, 1K5, 0.1%, ±25ppm, 1/16W, 0603	MC004868
Resistor, Thin Film, 562R, 0.1%, ±25ppm, 1/16W, 0603	MC004827	Resistor, Thin Film, 1K54, 0.1%, ±25ppm, 1/16W, 0603	MC004869
Resistor, Thin Film, 576R, 0.1%, ±25ppm, 1/16W, 0603	MC004828	Resistor, Thin Film, 1K58, 0.1%, ±25ppm, 1/16W, 0603	MC004870
Resistor, Thin Film, 590R, 0.1%, ±25ppm, 1/16W, 0603	MC004829	Resistor, Thin Film, 1K62, 0.1%, ±25ppm, 1/16W, 0603	MC004871
Resistor, Thin Film, 604R, 0.1%, ±25ppm, 1/16W, 0603	MC004830	Resistor, Thin Film, 1K65, 0.1%, ±25ppm, 1/16W, 0603	MC004872
Resistor, Thin Film, 619R, 0.1%, ±25ppm, 1/16W, 0603	MC004831	Resistor, Thin Film, 1K69, 0.1%, ±25ppm, 1/16W, 0603	MC004873
Resistor, Thin Film, 634R, 0.1%, ±25ppm, 1/16W, 0603	MC004832	Resistor, Thin Film, 1K74, 0.1%, ±25ppm, 1/16W, 0603	MC004874
Resistor, Thin Film, 649R, 0.1%, ±25ppm, 1/16W, 0603	MC004833	Resistor, Thin Film, 1K78, 0.1%, ±25ppm, 1/16W, 0603	MC004875

Thin Film Precision Chip Resistor

Description	Part Number	Description	Part Number
Resistor, Thin Film, 1K82, 0.1%, ±25ppm, 1/16W, 0603	MC004876	Resistor, Thin Film, 5K23, 0.1%, ±25ppm, 1/16W, 0603	MC004917
Resistor, Thin Film, 1K87, 0.1%, ±25ppm, 1/16W, 0603	MC004877	Resistor, Thin Film, 5K36, 0.1%, ±25ppm, 1/16W, 0603	MC004918
Resistor, Thin Film, 1K91, 0.1%, ±25ppm, 1/16W, 0603	MC004878	Resistor, Thin Film, 5K49, 0.1%, ±25ppm, 1/16W, 0603	MC004919
Resistor, Thin Film, 1K96, 0.1%, ±25ppm, 1/16W, 0603	MC004879	Resistor, Thin Film, 5K62, 0.1%, ±25ppm, 1/16W, 0603	MC004920
Resistor, Thin Film, 2K, 0.1%, ±25ppm, 1/16W, 0603	MC004880	Resistor, Thin Film, 5K76, 0.1%, ±25ppm, 1/16W, 0603	MC004921
Resistor, Thin Film, 2K05, 0.1%, ±25ppm, 1/16W, 0603	MC004881	Resistor, Thin Film, 5K9, 0.1%, ±25ppm, 1/16W, 0603	MC004922
Resistor, Thin Film, 2K1, 0.1%, ±25ppm, 1/16W, 0603	MC004882	Resistor, Thin Film, 6K04, 0.1%, ±25ppm, 1/16W, 0603	MC004923
Resistor, Thin Film, 2K15, 0.1%, ±25ppm, 1/16W, 0603	MC004883	Resistor, Thin Film, 6K19, 0.1%, ±25ppm, 1/16W, 0603	MC004924
Resistor, Thin Film, 2K21, 0.1%, ±25ppm, 1/16W, 0603	MC004884	Resistor, Thin Film, 6K34, 0.1%, ±25ppm, 1/16W, 0603	MC004925
Resistor, Thin Film, 2K26, 0.1%, ±25ppm, 1/16W, 0603	MC004885	Resistor, Thin Film, 6K49, 0.1%, ±25ppm, 1/16W, 0603	MC004926
Resistor, Thin Film, 2K32, 0.1%, ±25ppm, 1/16W, 0603	MC004886	Resistor, Thin Film, 6K65, 0.1%, ±25ppm, 1/16W, 0603	MC004927
Resistor, Thin Film, 2K37, 0.1%, ±25ppm, 1/16W, 0603	MC004887	Resistor, Thin Film, 6K81, 0.1%, ±25ppm, 1/16W, 0603	MC004928
Resistor, Thin Film, 2K43, 0.1%, ±25ppm, 1/16W, 0603	MC004888	Resistor, Thin Film, 6K98, 0.1%, ±25ppm, 1/16W, 0603	MC004929
Resistor, Thin Film, 2K49, 0.1%, ±25ppm, 1/16W, 0603	MC004889	Resistor, Thin Film, 7K15, 0.1%, ±25ppm, 1/16W, 0603	MC004930
Resistor, Thin Film, 2K55, 0.1%, ±25ppm, 1/16W, 0603	MC004890	Resistor, Thin Film, 7K32, 0.1%, ±25ppm, 1/16W, 0603	MC004931
Resistor, Thin Film, 2K61, 0.1%, ±25ppm, 1/16W, 0603	MC004891	Resistor, Thin Film, 7K5, 0.1%, ±25ppm, 1/16W, 0603	MC004932
Resistor, Thin Film, 2K67, 0.1%, ±25ppm, 1/16W, 0603	MC004892	Resistor, Thin Film, 7K68, 0.1%, ±25ppm, 1/16W, 0603	MC004933
Resistor, Thin Film, 2K74, 0.1%, ±25ppm, 1/16W, 0603	MC004893	Resistor, Thin Film, 7K87, 0.1%, ±25ppm, 1/16W, 0603	MC004934
Resistor, Thin Film, 2K8, 0.1%, ±25ppm, 1/16W, 0603	MC004894	Resistor, Thin Film, 8K06, 0.1%, ±25ppm, 1/16W, 0603	MC004935
Resistor, Thin Film, 2K94, 0.1%, ±25ppm, 1/16W, 0603	MC004895	Resistor, Thin Film, 8K25, 0.1%, ±25ppm, 1/16W, 0603	MC004936
Resistor, Thin Film, 3K16, 0.1%, ±25ppm, 1/16W, 0603	MC004896	Resistor, Thin Film, 8K45, 0.1%, ±25ppm, 1/16W, 0603	MC004937
Resistor, Thin Film, 3K24, 0.1%, ±25ppm, 1/16W, 0603	MC004897	Resistor, Thin Film, 8K66, 0.1%, ±25ppm, 1/16W, 0603	MC004938
Resistor, Thin Film, 3K32, 0.1%, ±25ppm, 1/16W, 0603	MC004898	Resistor, Thin Film, 8K87, 0.1%, ±25ppm, 1/16W, 0603	MC004939
Resistor, Thin Film, 3K4, 0.1%, ±25ppm, 1/16W, 0603	MC004899	Resistor, Thin Film, 9K09, 0.1%, ±25ppm, 1/16W, 0603	MC004940
Resistor, Thin Film, 3K48, 0.1%, ±25ppm, 1/16W, 0603	MC004900	Resistor, Thin Film, 9K31, 0.1%, ±25ppm, 1/16W, 0603	MC004941
Resistor, Thin Film, 3K57, 0.1%, ±25ppm, 1/16W, 0603	MC004901	Resistor, Thin Film, 9K53, 0.1%, ±25ppm, 1/16W, 0603	MC004942
Resistor, Thin Film, 3K65, 0.1%, ±25ppm, 1/16W, 0603	MC004902	Resistor, Thin Film, 9K76, 0.1%, ±25ppm, 1/16W, 0603	MC004943
Resistor, Thin Film, 3K74, 0.1%, ±25ppm, 1/16W, 0603	MC004903	Resistor, Thin Film, 10K2, 0.1%, ±25ppm, 1/16W, 0603	MC004945
Resistor, Thin Film, 3K83, 0.1%, ±25ppm, 1/16W, 0603	MC004904	Resistor, Thin Film, 10K5, 0.1%, ±25ppm, 1/16W, 0603	MC004946
Resistor, Thin Film, 3K92, 0.1%, ±25ppm, 1/16W, 0603	MC004905	Resistor, Thin Film, 10K7, 0.1%, ±25ppm, 1/16W, 0603	MC004947
Resistor, Thin Film, 4K02, 0.1%, ±25ppm, 1/16W, 0603	MC004906	Resistor, Thin Film, 11K, 0.1%, ±25ppm, 1/16W, 0603	MC004948
Resistor, Thin Film, 4K12, 0.1%, ±25ppm, 1/16W, 0603	MC004907	Resistor, Thin Film, 11K3, 0.1%, ±25ppm, 1/16W, 0603	MC004949
Resistor, Thin Film, 4K22, 0.1%, ±25ppm, 1/16W, 0603	MC004908	Resistor, Thin Film, 11K5, 0.1%, ±25ppm, 1/16W, 0603	MC004950
Resistor, Thin Film, 4K32, 0.1%, ±25ppm, 1/16W, 0603	MC004909	Resistor, Thin Film, 11K8, 0.1%, ±25ppm, 1/16W, 0603	MC004951
Resistor, Thin Film, 4K42, 0.1%, ±25ppm, 1/16W, 0603	MC004910	Resistor, Thin Film, 12K1, 0.1%, ±25ppm, 1/16W, 0603	MC004952
Resistor, Thin Film, 4K53, 0.1%, ±25ppm, 1/16W, 0603	MC004911	Resistor, Thin Film, 12K4, 0.1%, ±25ppm, 1/16W, 0603	MC004953
Resistor, Thin Film, 4K64, 0.1%, ±25ppm, 1/16W, 0603	MC004912	Resistor, Thin Film, 12K7, 0.1%, ±25ppm, 1/16W, 0603	MC004954
Resistor, Thin Film, 4K75, 0.1%, ±25ppm, 1/16W, 0603	MC004913	Resistor, Thin Film, 13K, 0.1%, ±25ppm, 1/16W, 0603	MC004955
Resistor, Thin Film, 4K87, 0.1%, ±25ppm, 1/16W, 0603	MC004914	Resistor, Thin Film, 13K3, 0.1%, ±25ppm, 1/16W, 0603	MC004956
Resistor, Thin Film, 4K99, 0.1%, ±25ppm, 1/16W, 0603	MC004915	Resistor, Thin Film, 13K7, 0.1%, ±25ppm, 1/16W, 0603	MC004957
Resistor, Thin Film, 5K11, 0.1%, ±25ppm, 1/16W, 0603	MC004916	Resistor, Thin Film, 14K, 0.1%, ±25ppm, 1/16W, 0603	MC004958

www.element14.com
www.farnell.com
www.newark.com



Thin Film Precision Chip Resistor

Description	Part Number	Description	Part Number
Resistor, Thin Film, 14K3, 0.1%, ±25ppm, 1/16W, 0603	MC004959	Resistor, Thin Film, 42K2, 0.1%, ±25ppm, 1/16W, 0603	MC005001
Resistor, Thin Film, 14K7, 0.1%, ±25ppm, 1/16W, 0603	MC004960	Resistor, Thin Film, 43K2, 0.1%, ±25ppm, 1/16W, 0603	MC005002
Resistor, Thin Film, 15K4, 0.1%, ±25ppm, 1/16W, 0603	MC004962	Resistor, Thin Film, 44K2, 0.1%, ±25ppm, 1/16W, 0603	MC005003
Resistor, Thin Film, 15K8, 0.1%, ±25ppm, 1/16W, 0603	MC004963	Resistor, Thin Film, 45K3, 0.1%, ±25ppm, 1/16W, 0603	MC005004
Resistor, Thin Film, 16K2, 0.1%, ±25ppm, 1/16W, 0603	MC004964	Resistor, Thin Film, 46K4, 0.1%, ±25ppm, 1/16W, 0603	MC005005
Resistor, Thin Film, 16K5, 0.1%, ±25ppm, 1/16W, 0603	MC004965	Resistor, Thin Film, 47K5, 0.1%, ±25ppm, 1/16W, 0603	MC005006
Resistor, Thin Film, 16K9, 0.1%, ±25ppm, 1/16W, 0603	MC004966	Resistor, Thin Film, 48K7, 0.1%, ±25ppm, 1/16W, 0603	MC005007
Resistor, Thin Film, 17K4, 0.1%, ±25ppm, 1/16W, 0603	MC004967	Resistor, Thin Film, 49K9, 0.1%, ±25ppm, 1/16W, 0603	MC005008
Resistor, Thin Film, 17K8, 0.1%, ±25ppm, 1/16W, 0603	MC004968	Resistor, Thin Film, 51K1, 0.1%, ±25ppm, 1/16W, 0603	MC005009
Resistor, Thin Film, 18K2, 0.1%, ±25ppm, 1/16W, 0603	MC004969	Resistor, Thin Film, 52K3, 0.1%, ±25ppm, 1/16W, 0603	MC005010
Resistor, Thin Film, 18K7, 0.1%, ±25ppm, 1/16W, 0603	MC004970	Resistor, Thin Film, 53K6, 0.1%, ±25ppm, 1/16W, 0603	MC005011
Resistor, Thin Film, 19K1, 0.1%, ±25ppm, 1/16W, 0603	MC004971	Resistor, Thin Film, 54K9, 0.1%, ±25ppm, 1/16W, 0603	MC005012
Resistor, Thin Film, 19K6, 0.1%, ±25ppm, 1/16W, 0603	MC004972	Resistor, Thin Film, 56K2, 0.1%, ±25ppm, 1/16W, 0603	MC005013
Resistor, Thin Film, 20K, 0.1%, ±25ppm, 1/16W, 0603	MC004973	Resistor, Thin Film, 57K6, 0.1%, ±25ppm, 1/16W, 0603	MC005014
Resistor, Thin Film, 20K5, 0.1%, ±25ppm, 1/16W, 0603	MC004974	Resistor, Thin Film, 59K, 0.1%, ±25ppm, 1/16W, 0603	MC005015
Resistor, Thin Film, 21K, 0.1%, ±25ppm, 1/16W, 0603	MC004975	Resistor, Thin Film, 60K4, 0.1%, ±25ppm, 1/16W, 0603	MC005016
Resistor, Thin Film, 21K5, 0.1%, ±25ppm, 1/16W, 0603	MC004976	Resistor, Thin Film, 61K9, 0.1%, ±25ppm, 1/16W, 0603	MC005017
Resistor, Thin Film, 22K1, 0.1%, ±25ppm, 1/16W, 0603	MC004977	Resistor, Thin Film, 63K4, 0.1%, ±25ppm, 1/16W, 0603	MC005018
Resistor, Thin Film, 22K6, 0.1%, ±25ppm, 1/16W, 0603	MC004978	Resistor, Thin Film, 64K9, 0.1%, ±25ppm, 1/16W, 0603	MC005019
Resistor, Thin Film, 23K2, 0.1%, ±25ppm, 1/16W, 0603	MC004979	Resistor, Thin Film, 66K5, 0.1%, ±25ppm, 1/16W, 0603	MC005020
Resistor, Thin Film, 23K7, 0.1%, ±25ppm, 1/16W, 0603	MC004980	Resistor, Thin Film, 68K1, 0.1%, ±25ppm, 1/16W, 0603	MC005021
Resistor, Thin Film, 24K3, 0.1%, ±25ppm, 1/16W, 0603	MC004981	Resistor, Thin Film, 69K8, 0.1%, ±25ppm, 1/16W, 0603	MC005022
Resistor, Thin Film, 24K9, 0.1%, ±25ppm, 1/16W, 0603	MC004982	Resistor, Thin Film, 71K5, 0.1%, ±25ppm, 1/16W, 0603	MC005023
Resistor, Thin Film, 25K5, 0.1%, ±25ppm, 1/16W, 0603	MC004983	Resistor, Thin Film, 73K2, 0.1%, ±25ppm, 1/16W, 0603	MC005024
Resistor, Thin Film, 26K1, 0.1%, ±25ppm, 1/16W, 0603	MC004984	Resistor, Thin Film, 75K, 0.1%, ±25ppm, 1/16W, 0603	MC005025
Resistor, Thin Film, 26K7, 0.1%, ±25ppm, 1/16W, 0603	MC004985	Resistor, Thin Film, 76K8, 0.1%, ±25ppm, 1/16W, 0603	MC005026
Resistor, Thin Film, 27K4, 0.1%, ±25ppm, 1/16W, 0603	MC004986	Resistor, Thin Film, 78K7, 0.1%, ±25ppm, 1/16W, 0603	MC005027
Resistor, Thin Film, 28K, 0.1%, ±25ppm, 1/16W, 0603	MC004987	Resistor, Thin Film, 80K6, 0.1%, ±25ppm, 1/16W, 0603	MC005028
Resistor, Thin Film, 29K4, 0.1%, ±25ppm, 1/16W, 0603	MC004988	Resistor, Thin Film, 82K5, 0.1%, ±25ppm, 1/16W, 0603	MC005029
Resistor, Thin Film, 31K6, 0.1%, ±25ppm, 1/16W, 0603	MC004989	Resistor, Thin Film, 84K5, 0.1%, ±25ppm, 1/16W, 0603	MC005030
Resistor, Thin Film, 32K4, 0.1%, ±25ppm, 1/16W, 0603	MC004990	Resistor, Thin Film, 86K6, 0.1%, ±25ppm, 1/16W, 0603	MC005031
Resistor, Thin Film, 33K2, 0.1%, ±25ppm, 1/16W, 0603	MC004991	Resistor, Thin Film, 88K7, 0.1%, ±25ppm, 1/16W, 0603	MC005032
Resistor, Thin Film, 34K, 0.1%, ±25ppm, 1/16W, 0603	MC004992	Resistor, Thin Film, 90K9, 0.1%, ±25ppm, 1/16W, 0603	MC005033
Resistor, Thin Film, 34K8, 0.1%, ±25ppm, 1/16W, 0603	MC004993	Resistor, Thin Film, 93K1, 0.1%, ±25ppm, 1/16W, 0603	MC005034
Resistor, Thin Film, 35K7, 0.1%, ±25ppm, 1/16W, 0603	MC004994	Resistor, Thin Film, 95K3, 0.1%, ±25ppm, 1/16W, 0603	MC005035
Resistor, Thin Film, 36K5, 0.1%, ±25ppm, 1/16W, 0603	MC004995	Resistor, Thin Film, 97K6, 0.1%, ±25ppm, 1/16W, 0603	MC005036
Resistor, Thin Film, 37K4, 0.1%, ±25ppm, 1/16W, 0603	MC004996	Resistor, Thin Film, 102K, 0.1%, ±25ppm, 1/16W, 0603	MC005038
Resistor, Thin Film, 38K3, 0.1%, ±25ppm, 1/16W, 0603	MC004997	Resistor, Thin Film, 105K, 0.1%, ±25ppm, 1/16W, 0603	MC005039
Resistor, Thin Film, 39K2, 0.1%, ±25ppm, 1/16W, 0603	MC004998	Resistor, Thin Film, 107K, 0.1%, ±25ppm, 1/16W, 0603	MC005040
Resistor, Thin Film, 40K2, 0.1%, ±25ppm, 1/16W, 0603	MC004999	Resistor, Thin Film, 110K, 0.1%, ±25ppm, 1/16W, 0603	MC005041
Resistor, Thin Film, 41K2, 0.1%, ±25ppm, 1/16W, 0603	MC005000	Resistor, Thin Film, 113K, 0.1%, ±25ppm, 1/16W, 0603	MC005042

www.element14.com
www.farnell.com
www.newark.com



Thin Film Precision Chip Resistor

Description	Part Number	Description	Part Number
Resistor, Thin Film, 115K, 0.1%, ±25ppm, 1/16W, 0603	MC005043	Resistor, Thin Film, 332K, 0.1%, ±25ppm, 1/16W, 0603	MC005084
Resistor, Thin Film, 118K, 0.1%, ±25ppm, 1/16W, 0603	MC005044	Resistor, Thin Film, 340K, 0.1%, ±25ppm, 1/16W, 0603	MC005085
Resistor, Thin Film, 121K, 0.1%, ±25ppm, 1/16W, 0603	MC005045	Resistor, Thin Film, 348K, 0.1%, ±25ppm, 1/16W, 0603	MC005086
Resistor, Thin Film, 124K, 0.1%, ±25ppm, 1/16W, 0603	MC005046	Resistor, Thin Film, 357K, 0.1%, ±25ppm, 1/16W, 0603	MC005087
Resistor, Thin Film, 127K, 0.1%, ±25ppm, 1/16W, 0603	MC005047	Resistor, Thin Film, 365K, 0.1%, ±25ppm, 1/16W, 0603	MC005088
Resistor, Thin Film, 130K, 0.1%, ±25ppm, 1/16W, 0603	MC005048	Resistor, Thin Film, 374K, 0.1%, ±25ppm, 1/16W, 0603	MC005089
Resistor, Thin Film, 133K, 0.1%, ±25ppm, 1/16W, 0603	MC005049	Resistor, Thin Film, 383K, 0.1%, ±25ppm, 1/16W, 0603	MC005090
Resistor, Thin Film, 137K, 0.1%, ±25ppm, 1/16W, 0603	MC005050	Resistor, Thin Film, 392K, 0.1%, ±25ppm, 1/16W, 0603	MC005091
Resistor, Thin Film, 140K, 0.1%, ±25ppm, 1/16W, 0603	MC005051	Resistor, Thin Film, 402K, 0.1%, ±25ppm, 1/16W, 0603	MC005092
Resistor, Thin Film, 143K, 0.1%, ±25ppm, 1/16W, 0603	MC005052	Resistor, Thin Film, 412K, 0.1%, ±25ppm, 1/16W, 0603	MC005093
Resistor, Thin Film, 147K, 0.1%, ±25ppm, 1/16W, 0603	MC005053	Resistor, Thin Film, 422K, 0.1%, ±25ppm, 1/16W, 0603	MC005094
Resistor, Thin Film, 150K, 0.1%, ±25ppm, 1/16W, 0603	MC005054	Resistor, Thin Film, 432K, 0.1%, ±25ppm, 1/16W, 0603	MC005095
Resistor, Thin Film, 154K, 0.1%, ±25ppm, 1/16W, 0603	MC005055	Resistor, Thin Film, 442K, 0.1%, ±25ppm, 1/16W, 0603	MC005096
Resistor, Thin Film, 158K, 0.1%, ±25ppm, 1/16W, 0603	MC005056	Resistor, Thin Film, 453K, 0.1%, ±25ppm, 1/16W, 0603	MC005097
Resistor, Thin Film, 162K, 0.1%, ±25ppm, 1/16W, 0603	MC005057	Resistor, Thin Film, 464K, 0.1%, ±25ppm, 1/16W, 0603	MC005098
Resistor, Thin Film, 165K, 0.1%, ±25ppm, 1/16W, 0603	MC005058	Resistor, Thin Film, 475K, 0.1%, ±25ppm, 1/16W, 0603	MC005099
Resistor, Thin Film, 169K, 0.1%, ±25ppm, 1/16W, 0603	MC005059	Resistor, Thin Film, 487K, 0.1%, ±25ppm, 1/16W, 0603	MC005100
Resistor, Thin Film, 174K, 0.1%, ±25ppm, 1/16W, 0603	MC005060	Resistor, Thin Film, 499K, 0.1%, ±25ppm, 1/16W, 0603	MC005101
Resistor, Thin Film, 178K, 0.1%, ±25ppm, 1/16W, 0603	MC005061	Resistor, Thin Film, 511K, 0.1%, ±25ppm, 1/16W, 0603	MC005102
Resistor, Thin Film, 182K, 0.1%, ±25ppm, 1/16W, 0603	MC005062	Resistor, Thin Film, 523K, 0.1%, ±25ppm, 1/16W, 0603	MC005103
Resistor, Thin Film, 187K, 0.1%, ±25ppm, 1/16W, 0603	MC005063	Resistor, Thin Film, 536K, 0.1%, ±25ppm, 1/16W, 0603	MC005104
Resistor, Thin Film, 191K, 0.1%, ±25ppm, 1/16W, 0603	MC005064	Resistor, Thin Film, 549K, 0.1%, ±25ppm, 1/16W, 0603	MC005105
Resistor, Thin Film, 196K, 0.1%, ±25ppm, 1/16W, 0603	MC005065	Resistor, Thin Film, 562K, 0.1%, ±25ppm, 1/16W, 0603	MC005106
Resistor, Thin Film, 200K, 0.1%, ±25ppm, 1/16W, 0603	MC005066	Resistor, Thin Film, 576K, 0.1%, ±25ppm, 1/16W, 0603	MC005107
Resistor, Thin Film, 205K, 0.1%, ±25ppm, 1/16W, 0603	MC005067	Resistor, Thin Film, 590K, 0.1%, ±25ppm, 1/16W, 0603	MC005108
Resistor, Thin Film, 210K, 0.1%, ±25ppm, 1/16W, 0603	MC005068	Resistor, Thin Film, 604K, 0.1%, ±25ppm, 1/16W, 0603	MC005109
Resistor, Thin Film, 215K, 0.1%, ±25ppm, 1/16W, 0603	MC005069	Resistor, Thin Film, 619K, 0.1%, ±25ppm, 1/16W, 0603	MC005110
Resistor, Thin Film, 221K, 0.1%, ±25ppm, 1/16W, 0603	MC005070	Resistor, Thin Film, 634K, 0.1%, ±25ppm, 1/16W, 0603	MC005111
Resistor, Thin Film, 226K, 0.1%, ±25ppm, 1/16W, 0603	MC005071	Resistor, Thin Film, 649K, 0.1%, ±25ppm, 1/16W, 0603	MC005112
Resistor, Thin Film, 232K, 0.1%, ±25ppm, 1/16W, 0603	MC005072	Resistor, Thin Film, 665K, 0.1%, ±25ppm, 1/16W, 0603	MC005113
Resistor, Thin Film, 237K, 0.1%, ±25ppm, 1/16W, 0603	MC005073	Resistor, Thin Film, 681K, 0.1%, ±25ppm, 1/16W, 0603	MC005114
Resistor, Thin Film, 243K, 0.1%, ±25ppm, 1/16W, 0603	MC005074	Resistor, Thin Film, 698K, 0.1%, ±25ppm, 1/16W, 0603	MC005115
Resistor, Thin Film, 249K, 0.1%, ±25ppm, 1/16W, 0603	MC005075	Resistor, Thin Film, 715K, 0.1%, ±25ppm, 1/16W, 0603	MC005116
Resistor, Thin Film, 255K, 0.1%, ±25ppm, 1/16W, 0603	MC005076	Resistor, Thin Film, 732K, 0.1%, ±25ppm, 1/16W, 0603	MC005117
Resistor, Thin Film, 261K, 0.1%, ±25ppm, 1/16W, 0603	MC005077	Resistor, Thin Film, 750K, 0.1%, ±25ppm, 1/16W, 0603	MC005118
Resistor, Thin Film, 267K, 0.1%, ±25ppm, 1/16W, 0603	MC005078	Resistor, Thin Film, 768K, 0.1%, ±25ppm, 1/16W, 0603	MC005119
Resistor, Thin Film, 274K, 0.1%, ±25ppm, 1/16W, 0603	MC005079	Resistor, Thin Film, 787K, 0.1%, ±25ppm, 1/16W, 0603	MC005120
Resistor, Thin Film, 280K, 0.1%, ±25ppm, 1/16W, 0603	MC005080	Resistor, Thin Film, 806K, 0.1%, ±25ppm, 1/16W, 0603	MC005121
Resistor, Thin Film, 294K, 0.1%, ±25ppm, 1/16W, 0603	MC005081	Resistor, Thin Film, 825K, 0.1%, ±25ppm, 1/16W, 0603	MC005122
Resistor, Thin Film, 316K, 0.1%, ±25ppm, 1/16W, 0603	MC005082	Resistor, Thin Film, 845K, 0.1%, ±25ppm, 1/16W, 0603	MC005123
Resistor, Thin Film, 324K, 0.1%, ±25ppm, 1/16W, 0603	MC005083	Resistor, Thin Film, 866K, 0.1%, ±25ppm, 1/16W, 0603	MC005124

www.element14.com
www.farnell.com
www.newark.com



Thin Film Precision Chip Resistor

Description	Part Number	Description	Part Number
Resistor, Thin Film, 887K, 0.1%, ±25ppm, 1/16W, 0603	MC005125	Resistor, Thin Film, 19R1, 0.1%, ±25ppm, 1/10W, 0805	MC005166
Resistor, Thin Film, 909K, 0.1%, ±25ppm, 1/16W, 0603	MC005126	Resistor, Thin Film, 19R6, 0.1%, ±25ppm, 1/10W, 0805	MC005167
Resistor, Thin Film, 931K, 0.1%, ±25ppm, 1/16W, 0603	MC005127	Resistor, Thin Film, 20R, 0.1%, ±25ppm, 1/10W, 0805	MC005168
Resistor, Thin Film, 953K, 0.1%, ±25ppm, 1/16W, 0603	MC005128	Resistor, Thin Film, 20R5, 0.1%, ±25ppm, 1/10W, 0805	MC005169
Resistor, Thin Film, 976K, 0.1%, ±25ppm, 1/16W, 0603	MC005129	Resistor, Thin Film, 21R, 0.1%, ±25ppm, 1/10W, 0805	MC005170
Resistor, Thin Film, 1M, 0.1%, ±25ppm, 1/16W, 0603	MC005130	Resistor, Thin Film, 21R5, 0.1%, ±25ppm, 1/10W, 0805	MC005171
Resistor, Thin Film, 4R7, 0.1%, ±25ppm, 1/10W, 0805	MC005131	Resistor, Thin Film, 22R1, 0.1%, ±25ppm, 1/10W, 0805	MC005172
Resistor, Thin Film, 5R1, 0.1%, ±25ppm, 1/10W, 0805	MC005132	Resistor, Thin Film, 22R6, 0.1%, ±25ppm, 1/10W, 0805	MC005173
Resistor, Thin Film, 5R6, 0.1%, ±25ppm, 1/10W, 0805	MC005133	Resistor, Thin Film, 23R2, 0.1%, ±25ppm, 1/10W, 0805	MC005174
Resistor, Thin Film, 6R2, 0.1%, ±25ppm, 1/10W, 0805	MC005134	Resistor, Thin Film, 23R7, 0.1%, ±25ppm, 1/10W, 0805	MC005175
Resistor, Thin Film, 6R8, 0.1%, ±25ppm, 1/10W, 0805	MC005135	Resistor, Thin Film, 24R3, 0.1%, ±25ppm, 1/10W, 0805	MC005176
Resistor, Thin Film, 7R5, 0.1%, ±25ppm, 1/10W, 0805	MC005136	Resistor, Thin Film, 24R9, 0.1%, ±25ppm, 1/10W, 0805	MC005177
Resistor, Thin Film, 8R2, 0.1%, ±25ppm, 1/10W, 0805	MC005137	Resistor, Thin Film, 25R5, 0.1%, ±25ppm, 1/10W, 0805	MC005178
Resistor, Thin Film, 9R1, 0.1%, ±25ppm, 1/10W, 0805	MC005138	Resistor, Thin Film, 26R1, 0.1%, ±25ppm, 1/10W, 0805	MC005179
Resistor, Thin Film, 10R, 0.1%, ±25ppm, 1/10W, 0805	MC005139	Resistor, Thin Film, 26R7, 0.1%, ±25ppm, 1/10W, 0805	MC005180
Resistor, Thin Film, 10R2, 0.1%, ±25ppm, 1/10W, 0805	MC005140	Resistor, Thin Film, 27R4, 0.1%, ±25ppm, 1/10W, 0805	MC005181
Resistor, Thin Film, 10R5, 0.1%, ±25ppm, 1/10W, 0805	MC005141	Resistor, Thin Film, 28R, 0.1%, ±25ppm, 1/10W, 0805	MC005182
Resistor, Thin Film, 10R7, 0.1%, ±25ppm, 1/10W, 0805	MC005142	Resistor, Thin Film, 29R4, 0.1%, ±25ppm, 1/10W, 0805	MC005183
Resistor, Thin Film, 11R, 0.1%, ±25ppm, 1/10W, 0805	MC005143	Resistor, Thin Film, 31R6, 0.1%, ±25ppm, 1/10W, 0805	MC005184
Resistor, Thin Film, 11R3, 0.1%, ±25ppm, 1/10W, 0805	MC005144	Resistor, Thin Film, 32R4, 0.1%, ±25ppm, 1/10W, 0805	MC005185
Resistor, Thin Film, 11R5, 0.1%, ±25ppm, 1/10W, 0805	MC005145	Resistor, Thin Film, 33R2, 0.1%, ±25ppm, 1/10W, 0805	MC005186
Resistor, Thin Film, 11R8, 0.1%, ±25ppm, 1/10W, 0805	MC005146	Resistor, Thin Film, 34R, 0.1%, ±25ppm, 1/10W, 0805	MC005187
Resistor, Thin Film, 12R1, 0.1%, ±25ppm, 1/10W, 0805	MC005147	Resistor, Thin Film, 34R8, 0.1%, ±25ppm, 1/10W, 0805	MC005188
Resistor, Thin Film, 12R4, 0.1%, ±25ppm, 1/10W, 0805	MC005148	Resistor, Thin Film, 35R7, 0.1%, ±25ppm, 1/10W, 0805	MC005189
Resistor, Thin Film, 12R7, 0.1%, ±25ppm, 1/10W, 0805	MC005149	Resistor, Thin Film, 36R5, 0.1%, ±25ppm, 1/10W, 0805	MC005190
Resistor, Thin Film, 13R, 0.1%, ±25ppm, 1/10W, 0805	MC005150	Resistor, Thin Film, 37R4, 0.1%, ±25ppm, 1/10W, 0805	MC005191
Resistor, Thin Film, 13R3, 0.1%, ±25ppm, 1/10W, 0805	MC005151	Resistor, Thin Film, 38R3, 0.1%, ±25ppm, 1/10W, 0805	MC005192
Resistor, Thin Film, 13R7, 0.1%, ±25ppm, 1/10W, 0805	MC005152	Resistor, Thin Film, 39R2, 0.1%, ±25ppm, 1/10W, 0805	MC005193
Resistor, Thin Film, 14R, 0.1%, ±25ppm, 1/10W, 0805	MC005153	Resistor, Thin Film, 40R2, 0.1%, ±25ppm, 1/10W, 0805	MC005194
Resistor, Thin Film, 14R3, 0.1%, ±25ppm, 1/10W, 0805	MC005154	Resistor, Thin Film, 41R2, 0.1%, ±25ppm, 1/10W, 0805	MC005195
Resistor, Thin Film, 14R7, 0.1%, ±25ppm, 1/10W, 0805	MC005155	Resistor, Thin Film, 42R2, 0.1%, ±25ppm, 1/10W, 0805	MC005196
Resistor, Thin Film, 15R, 0.1%, ±25ppm, 1/10W, 0805	MC005156	Resistor, Thin Film, 43R2, 0.1%, ±25ppm, 1/10W, 0805	MC005197
Resistor, Thin Film, 15R4, 0.1%, ±25ppm, 1/10W, 0805	MC005157	Resistor, Thin Film, 44R2, 0.1%, ±25ppm, 1/10W, 0805	MC005198
Resistor, Thin Film, 15R8, 0.1%, ±25ppm, 1/10W, 0805	MC005158	Resistor, Thin Film, 45R3, 0.1%, ±25ppm, 1/10W, 0805	MC005199
Resistor, Thin Film, 16R2, 0.1%, ±25ppm, 1/10W, 0805	MC005159	Resistor, Thin Film, 46R4, 0.1%, ±25ppm, 1/10W, 0805	MC005200
Resistor, Thin Film, 16R5, 0.1%, ±25ppm, 1/10W, 0805	MC005160	Resistor, Thin Film, 47R5, 0.1%, ±25ppm, 1/10W, 0805	MC005201
Resistor, Thin Film, 16R9, 0.1%, ±25ppm, 1/10W, 0805	MC005161	Resistor, Thin Film, 48R7, 0.1%, ±25ppm, 1/10W, 0805	MC005202
Resistor, Thin Film, 17R4, 0.1%, ±25ppm, 1/10W, 0805	MC005162	Resistor, Thin Film, 49R9, 0.1%, ±25ppm, 1/10W, 0805	MC005203
Resistor, Thin Film, 17R8, 0.1%, ±25ppm, 1/10W, 0805	MC005163	Resistor, Thin Film, 51R1, 0.1%, ±25ppm, 1/10W, 0805	MC005204
Resistor, Thin Film, 18R2, 0.1%, ±25ppm, 1/10W, 0805	MC005164	Resistor, Thin Film, 52R3, 0.1%, ±25ppm, 1/10W, 0805	MC005205
Resistor, Thin Film, 18R7, 0.1%, ±25ppm, 1/10W, 0805	MC005165	Resistor, Thin Film, 53R6, 0.1%, ±25ppm, 1/10W, 0805	MC005206

www.element14.com
www.farnell.com
www.newark.com



Thin Film Precision Chip Resistor

Description	Part Number	Description	Part Number
Resistor, Thin Film, 237K, 0.1%, ±25ppm, 1/10W, 0805	MC005547	Resistor, Thin Film, 681K, 0.1%, ±25ppm, 1/10W, 0805	MC005588
Resistor, Thin Film, 243K, 0.1%, ±25ppm, 1/10W, 0805	MC005548	Resistor, Thin Film, 698K, 0.1%, ±25ppm, 1/10W, 0805	MC005589
Resistor, Thin Film, 249K, 0.1%, ±25ppm, 1/10W, 0805	MC005549	Resistor, Thin Film, 715K, 0.1%, ±25ppm, 1/10W, 0805	MC005590
Resistor, Thin Film, 255K, 0.1%, ±25ppm, 1/10W, 0805	MC005550	Resistor, Thin Film, 732K, 0.1%, ±25ppm, 1/10W, 0805	MC005591
Resistor, Thin Film, 261K, 0.1%, ±25ppm, 1/10W, 0805	MC005551	Resistor, Thin Film, 750K, 0.1%, ±25ppm, 1/10W, 0805	MC005592
Resistor, Thin Film, 267K, 0.1%, ±25ppm, 1/10W, 0805	MC005552	Resistor, Thin Film, 768K, 0.1%, ±25ppm, 1/10W, 0805	MC005593
Resistor, Thin Film, 274K, 0.1%, ±25ppm, 1/10W, 0805	MC005553	Resistor, Thin Film, 787K, 0.1%, ±25ppm, 1/10W, 0805	MC005594
Resistor, Thin Film, 280K, 0.1%, ±25ppm, 1/10W, 0805	MC005554	Resistor, Thin Film, 806K, 0.1%, ±25ppm, 1/10W, 0805	MC005595
Resistor, Thin Film, 294K, 0.1%, ±25ppm, 1/10W, 0805	MC005555	Resistor, Thin Film, 825K, 0.1%, ±25ppm, 1/10W, 0805	MC005596
Resistor, Thin Film, 316K, 0.1%, ±25ppm, 1/10W, 0805	MC005556	Resistor, Thin Film, 845K, 0.1%, ±25ppm, 1/10W, 0805	MC005597
Resistor, Thin Film, 324K, 0.1%, ±25ppm, 1/10W, 0805	MC005557	Resistor, Thin Film, 866K, 0.1%, ±25ppm, 1/10W, 0805	MC005598
Resistor, Thin Film, 332K, 0.1%, ±25ppm, 1/10W, 0805	MC005558	Resistor, Thin Film, 887K, 0.1%, ±25ppm, 1/10W, 0805	MC005599
Resistor, Thin Film, 340K, 0.1%, ±25ppm, 1/10W, 0805	MC005559	Resistor, Thin Film, 909K, 0.1%, ±25ppm, 1/10W, 0805	MC005600
Resistor, Thin Film, 348K, 0.1%, ±25ppm, 1/10W, 0805	MC005560	Resistor, Thin Film, 931K, 0.1%, ±25ppm, 1/10W, 0805	MC005601
Resistor, Thin Film, 357K, 0.1%, ±25ppm, 1/10W, 0805	MC005561	Resistor, Thin Film, 953K, 0.1%, ±25ppm, 1/10W, 0805	MC005602
Resistor, Thin Film, 365K, 0.1%, ±25ppm, 1/10W, 0805	MC005562	Resistor, Thin Film, 976K, 0.1%, ±25ppm, 1/10W, 0805	MC005603
Resistor, Thin Film, 374K, 0.1%, ±25ppm, 1/10W, 0805	MC005563	Resistor, Thin Film, 1M1, 0.1%, ±25ppm, 1/10W, 0805	MC005605
Resistor, Thin Film, 383K, 0.1%, ±25ppm, 1/10W, 0805	MC005564	Resistor, Thin Film, 1M2, 0.1%, ±25ppm, 1/10W, 0805	MC005606
Resistor, Thin Film, 392K, 0.1%, ±25ppm, 1/10W, 0805	MC005565	Resistor, Thin Film, 1M3, 0.1%, ±25ppm, 1/10W, 0805	MC005607
Resistor, Thin Film, 402K, 0.1%, ±25ppm, 1/10W, 0805	MC005566	Resistor, Thin Film, 1M5, 0.1%, ±25ppm, 1/10W, 0805	MC005608
Resistor, Thin Film, 412K, 0.1%, ±25ppm, 1/10W, 0805	MC005567	Resistor, Thin Film, 1M6, 0.1%, ±25ppm, 1/10W, 0805	MC005609
Resistor, Thin Film, 422K, 0.1%, ±25ppm, 1/10W, 0805	MC005568	Resistor, Thin Film, 1M8, 0.1%, ±25ppm, 1/10W, 0805	MC005610
Resistor, Thin Film, 432K, 0.1%, ±25ppm, 1/10W, 0805	MC005569	Resistor, Thin Film, 2M, 0.1%, ±25ppm, 1/10W, 0805	MC005611
Resistor, Thin Film, 442K, 0.1%, ±25ppm, 1/10W, 0805	MC005570	Resistor, Thin Film, 4R7, 0.1%, ±25ppm, 1/8W, 1206	MC005612
Resistor, Thin Film, 453K, 0.1%, ±25ppm, 1/10W, 0805	MC005571	Resistor, Thin Film, 5R1, 0.1%, ±25ppm, 1/8W, 1206	MC005613
Resistor, Thin Film, 464K, 0.1%, ±25ppm, 1/10W, 0805	MC005572	Resistor, Thin Film, 5R6, 0.1%, ±25ppm, 1/8W, 1206	MC005614
Resistor, Thin Film, 475K, 0.1%, ±25ppm, 1/10W, 0805	MC005573	Resistor, Thin Film, 6R2, 0.1%, ±25ppm, 1/8W, 1206	MC005615
Resistor, Thin Film, 487K, 0.1%, ±25ppm, 1/10W, 0805	MC005574	Resistor, Thin Film, 6R8, 0.1%, ±25ppm, 1/8W, 1206	MC005616
Resistor, Thin Film, 499K, 0.1%, ±25ppm, 1/10W, 0805	MC005575	Resistor, Thin Film, 7R5, 0.1%, ±25ppm, 1/8W, 1206	MC005617
Resistor, Thin Film, 511K, 0.1%, ±25ppm, 1/10W, 0805	MC005576	Resistor, Thin Film, 8R2, 0.1%, ±25ppm, 1/8W, 1206	MC005618
Resistor, Thin Film, 523K, 0.1%, ±25ppm, 1/10W, 0805	MC005577	Resistor, Thin Film, 9R1, 0.1%, ±25ppm, 1/8W, 1206	MC005619
Resistor, Thin Film, 536K, 0.1%, ±25ppm, 1/10W, 0805	MC005578	Resistor, Thin Film, 10R, 0.1%, ±25ppm, 1/8W, 1206	MC005620
Resistor, Thin Film, 549K, 0.1%, ±25ppm, 1/10W, 0805	MC005579	Resistor, Thin Film, 10R2, 0.1%, ±25ppm, 1/8W, 1206	MC005621
Resistor, Thin Film, 562K, 0.1%, ±25ppm, 1/10W, 0805	MC005580	Resistor, Thin Film, 10R5, 0.1%, ±25ppm, 1/8W, 1206	MC005622
Resistor, Thin Film, 576K, 0.1%, ±25ppm, 1/10W, 0805	MC005581	Resistor, Thin Film, 10R7, 0.1%, ±25ppm, 1/8W, 1206	MC005623
Resistor, Thin Film, 590K, 0.1%, ±25ppm, 1/10W, 0805	MC005582	Resistor, Thin Film, 11R, 0.1%, ±25ppm, 1/8W, 1206	MC005624
Resistor, Thin Film, 604K, 0.1%, ±25ppm, 1/10W, 0805	MC005583	Resistor, Thin Film, 11R3, 0.1%, ±25ppm, 1/8W, 1206	MC005625
Resistor, Thin Film, 619K, 0.1%, ±25ppm, 1/10W, 0805	MC005584	Resistor, Thin Film, 11R5, 0.1%, ±25ppm, 1/8W, 1206	MC005626
Resistor, Thin Film, 634K, 0.1%, ±25ppm, 1/10W, 0805	MC005585	Resistor, Thin Film, 11R8, 0.1%, ±25ppm, 1/8W, 1206	MC005627
Resistor, Thin Film, 649K, 0.1%, ±25ppm, 1/10W, 0805	MC005586	Resistor, Thin Film, 12R1, 0.1%, ±25ppm, 1/8W, 1206	MC005628
Resistor, Thin Film, 665K, 0.1%, ±25ppm, 1/10W, 0805	MC005587	Resistor, Thin Film, 12R4, 0.1%, ±25ppm, 1/8W, 1206	MC005629

www.element14.com
www.farnell.com
www.newark.com



Thin Film Precision Chip Resistor

Description	Part Number	Description	Part Number
Resistor, Thin Film, 12R7, 0.1%, ±25ppm, 1/8W, 1206	MC005630	Resistor, Thin Film, 36R5, 0.1%, ±25ppm, 1/8W, 1206	MC005671
Resistor, Thin Film, 13R, 0.1%, ±25ppm, 1/8W, 1206	MC005631	Resistor, Thin Film, 37R4, 0.1%, ±25ppm, 1/8W, 1206	MC005672
Resistor, Thin Film, 13R3, 0.1%, ±25ppm, 1/8W, 1206	MC005632	Resistor, Thin Film, 38R3, 0.1%, ±25ppm, 1/8W, 1206	MC005673
Resistor, Thin Film, 13R7, 0.1%, ±25ppm, 1/8W, 1206	MC005633	Resistor, Thin Film, 39R2, 0.1%, ±25ppm, 1/8W, 1206	MC005674
Resistor, Thin Film, 14R, 0.1%, ±25ppm, 1/8W, 1206	MC005634	Resistor, Thin Film, 40R2, 0.1%, ±25ppm, 1/8W, 1206	MC005675
Resistor, Thin Film, 14R3, 0.1%, ±25ppm, 1/8W, 1206	MC005635	Resistor, Thin Film, 41R2, 0.1%, ±25ppm, 1/8W, 1206	MC005676
Resistor, Thin Film, 14R7, 0.1%, ±25ppm, 1/8W, 1206	MC005636	Resistor, Thin Film, 42R2, 0.1%, ±25ppm, 1/8W, 1206	MC005677
Resistor, Thin Film, 15R, 0.1%, ±25ppm, 1/8W, 1206	MC005637	Resistor, Thin Film, 43R2, 0.1%, ±25ppm, 1/8W, 1206	MC005678
Resistor, Thin Film, 15R4, 0.1%, ±25ppm, 1/8W, 1206	MC005638	Resistor, Thin Film, 44R2, 0.1%, ±25ppm, 1/8W, 1206	MC005679
Resistor, Thin Film, 15R8, 0.1%, ±25ppm, 1/8W, 1206	MC005639	Resistor, Thin Film, 45R3, 0.1%, ±25ppm, 1/8W, 1206	MC005680
Resistor, Thin Film, 16R2, 0.1%, ±25ppm, 1/8W, 1206	MC005640	Resistor, Thin Film, 46R4, 0.1%, ±25ppm, 1/8W, 1206	MC005681
Resistor, Thin Film, 16R5, 0.1%, ±25ppm, 1/8W, 1206	MC005641	Resistor, Thin Film, 47R5, 0.1%, ±25ppm, 1/8W, 1206	MC005682
Resistor, Thin Film, 16R9, 0.1%, ±25ppm, 1/8W, 1206	MC005642	Resistor, Thin Film, 48R7, 0.1%, ±25ppm, 1/8W, 1206	MC005683
Resistor, Thin Film, 17R4, 0.1%, ±25ppm, 1/8W, 1206	MC005643	Resistor, Thin Film, 49R9, 0.1%, ±25ppm, 1/8W, 1206	MC005684
Resistor, Thin Film, 17R8, 0.1%, ±25ppm, 1/8W, 1206	MC005644	Resistor, Thin Film, 51R1, 0.1%, ±25ppm, 1/8W, 1206	MC005685
Resistor, Thin Film, 18R2, 0.1%, ±25ppm, 1/8W, 1206	MC005645	Resistor, Thin Film, 52R3, 0.1%, ±25ppm, 1/8W, 1206	MC005686
Resistor, Thin Film, 18R7, 0.1%, ±25ppm, 1/8W, 1206	MC005646	Resistor, Thin Film, 53R6, 0.1%, ±25ppm, 1/8W, 1206	MC005687
Resistor, Thin Film, 19R1, 0.1%, ±25ppm, 1/8W, 1206	MC005647	Resistor, Thin Film, 54R9, 0.1%, ±25ppm, 1/8W, 1206	MC005688
Resistor, Thin Film, 19R6, 0.1%, ±25ppm, 1/8W, 1206	MC005648	Resistor, Thin Film, 56R2, 0.1%, ±25ppm, 1/8W, 1206	MC005689
Resistor, Thin Film, 20R, 0.1%, ±25ppm, 1/8W, 1206	MC005649	Resistor, Thin Film, 57R6, 0.1%, ±25ppm, 1/8W, 1206	MC005690
Resistor, Thin Film, 20R5, 0.1%, ±25ppm, 1/8W, 1206	MC005650	Resistor, Thin Film, 59R, 0.1%, ±25ppm, 1/8W, 1206	MC005691
Resistor, Thin Film, 21R, 0.1%, ±25ppm, 1/8W, 1206	MC005651	Resistor, Thin Film, 60R4, 0.1%, ±25ppm, 1/8W, 1206	MC005692
Resistor, Thin Film, 21R5, 0.1%, ±25ppm, 1/8W, 1206	MC005652	Resistor, Thin Film, 61R9, 0.1%, ±25ppm, 1/8W, 1206	MC005693
Resistor, Thin Film, 22R1, 0.1%, ±25ppm, 1/8W, 1206	MC005653	Resistor, Thin Film, 63R4, 0.1%, ±25ppm, 1/8W, 1206	MC005694
Resistor, Thin Film, 22R6, 0.1%, ±25ppm, 1/8W, 1206	MC005654	Resistor, Thin Film, 64R9, 0.1%, ±25ppm, 1/8W, 1206	MC005695
Resistor, Thin Film, 23R2, 0.1%, ±25ppm, 1/8W, 1206	MC005655	Resistor, Thin Film, 66R5, 0.1%, ±25ppm, 1/8W, 1206	MC005696
Resistor, Thin Film, 23R7, 0.1%, ±25ppm, 1/8W, 1206	MC005656	Resistor, Thin Film, 68R1, 0.1%, ±25ppm, 1/8W, 1206	MC005697
Resistor, Thin Film, 24R3, 0.1%, ±25ppm, 1/8W, 1206	MC005657	Resistor, Thin Film, 69R8, 0.1%, ±25ppm, 1/8W, 1206	MC005698
Resistor, Thin Film, 24R9, 0.1%, ±25ppm, 1/8W, 1206	MC005658	Resistor, Thin Film, 71R5, 0.1%, ±25ppm, 1/8W, 1206	MC005699
Resistor, Thin Film, 25R5, 0.1%, ±25ppm, 1/8W, 1206	MC005659	Resistor, Thin Film, 73R2, 0.1%, ±25ppm, 1/8W, 1206	MC005700
Resistor, Thin Film, 26R1, 0.1%, ±25ppm, 1/8W, 1206	MC005660	Resistor, Thin Film, 75R, 0.1%, ±25ppm, 1/8W, 1206	MC005701
Resistor, Thin Film, 26R7, 0.1%, ±25ppm, 1/8W, 1206	MC005661	Resistor, Thin Film, 76R8, 0.1%, ±25ppm, 1/8W, 1206	MC005702
Resistor, Thin Film, 27R4, 0.1%, ±25ppm, 1/8W, 1206	MC005662	Resistor, Thin Film, 78R7, 0.1%, ±25ppm, 1/8W, 1206	MC005703
Resistor, Thin Film, 28R, 0.1%, ±25ppm, 1/8W, 1206	MC005663	Resistor, Thin Film, 80R6, 0.1%, ±25ppm, 1/8W, 1206	MC005704
Resistor, Thin Film, 29R4, 0.1%, ±25ppm, 1/8W, 1206	MC005664	Resistor, Thin Film, 82R5, 0.1%, ±25ppm, 1/8W, 1206	MC005705
Resistor, Thin Film, 31R6, 0.1%, ±25ppm, 1/8W, 1206	MC005665	Resistor, Thin Film, 84R5, 0.1%, ±25ppm, 1/8W, 1206	MC005706
Resistor, Thin Film, 32R4, 0.1%, ±25ppm, 1/8W, 1206	MC005666	Resistor, Thin Film, 86R6, 0.1%, ±25ppm, 1/8W, 1206	MC005707
Resistor, Thin Film, 33R2, 0.1%, ±25ppm, 1/8W, 1206	MC005667	Resistor, Thin Film, 88R7, 0.1%, ±25ppm, 1/8W, 1206	MC005708
Resistor, Thin Film, 34R, 0.1%, ±25ppm, 1/8W, 1206	MC005668	Resistor, Thin Film, 90R9, 0.1%, ±25ppm, 1/8W, 1206	MC005709
Resistor, Thin Film, 34R8, 0.1%, ±25ppm, 1/8W, 1206	MC005669	Resistor, Thin Film, 93R1, 0.1%, ±25ppm, 1/8W, 1206	MC005710
Resistor, Thin Film, 35R7, 0.1%, ±25ppm, 1/8W, 1206	MC005670	Resistor, Thin Film, 95R3, 0.1%, ±25ppm, 1/8W, 1206	MC005711

www.element14.com
www.farnell.com
www.newark.com



Thin Film Precision Chip Resistor

Description	Part Number	Description	Part Number
Resistor, Thin Film, 750R, 0.1%, ±25ppm, 1/8W, 1206	MC005794	Resistor, Thin Film, 2K, 0.1%, ±25ppm, 1/8W, 1206	MC005835
Resistor, Thin Film, 768R, 0.1%, ±25ppm, 1/8W, 1206	MC005795	Resistor, Thin Film, 2K05, 0.1%, ±25ppm, 1/8W, 1206	MC005836
Resistor, Thin Film, 787R, 0.1%, ±25ppm, 1/8W, 1206	MC005796	Resistor, Thin Film, 2K1, 0.1%, ±25ppm, 1/8W, 1206	MC005837
Resistor, Thin Film, 806R, 0.1%, ±25ppm, 1/8W, 1206	MC005797	Resistor, Thin Film, 2K15, 0.1%, ±25ppm, 1/8W, 1206	MC005838
Resistor, Thin Film, 825R, 0.1%, ±25ppm, 1/8W, 1206	MC005798	Resistor, Thin Film, 2K21, 0.1%, ±25ppm, 1/8W, 1206	MC005839
Resistor, Thin Film, 845R, 0.1%, ±25ppm, 1/8W, 1206	MC005799	Resistor, Thin Film, 2K26, 0.1%, ±25ppm, 1/8W, 1206	MC005840
Resistor, Thin Film, 866R, 0.1%, ±25ppm, 1/8W, 1206	MC005800	Resistor, Thin Film, 2K32, 0.1%, ±25ppm, 1/8W, 1206	MC005841
Resistor, Thin Film, 887R, 0.1%, ±25ppm, 1/8W, 1206	MC005801	Resistor, Thin Film, 2K37, 0.1%, ±25ppm, 1/8W, 1206	MC005842
Resistor, Thin Film, 909R, 0.1%, ±25ppm, 1/8W, 1206	MC005802	Resistor, Thin Film, 2K43, 0.1%, ±25ppm, 1/8W, 1206	MC005843
Resistor, Thin Film, 931R, 0.1%, ±25ppm, 1/8W, 1206	MC005803	Resistor, Thin Film, 2K49, 0.1%, ±25ppm, 1/8W, 1206	MC005844
Resistor, Thin Film, 953R, 0.1%, ±25ppm, 1/8W, 1206	MC005804	Resistor, Thin Film, 2K55, 0.1%, ±25ppm, 1/8W, 1206	MC005845
Resistor, Thin Film, 976R, 0.1%, ±25ppm, 1/8W, 1206	MC005805	Resistor, Thin Film, 2K61, 0.1%, ±25ppm, 1/8W, 1206	MC005846
Resistor, Thin Film, 1K, 0.1%, ±25ppm, 1/8W, 1206	MC005806	Resistor, Thin Film, 2K67, 0.1%, ±25ppm, 1/8W, 1206	MC005847
Resistor, Thin Film, 1K02, 0.1%, ±25ppm, 1/8W, 1206	MC005807	Resistor, Thin Film, 2K74, 0.1%, ±25ppm, 1/8W, 1206	MC005848
Resistor, Thin Film, 1K05, 0.1%, ±25ppm, 1/8W, 1206	MC005808	Resistor, Thin Film, 2K8, 0.1%, ±25ppm, 1/8W, 1206	MC005849
Resistor, Thin Film, 1K07, 0.1%, ±25ppm, 1/8W, 1206	MC005809	Resistor, Thin Film, 2K94, 0.1%, ±25ppm, 1/8W, 1206	MC005850
Resistor, Thin Film, 1K1, 0.1%, ±25ppm, 1/8W, 1206	MC005810	Resistor, Thin Film, 3K16, 0.1%, ±25ppm, 1/8W, 1206	MC005851
Resistor, Thin Film, 1K13, 0.1%, ±25ppm, 1/8W, 1206	MC005811	Resistor, Thin Film, 3K24, 0.1%, ±25ppm, 1/8W, 1206	MC005852
Resistor, Thin Film, 1K15, 0.1%, ±25ppm, 1/8W, 1206	MC005812	Resistor, Thin Film, 3K32, 0.1%, ±25ppm, 1/8W, 1206	MC005853
Resistor, Thin Film, 1K18, 0.1%, ±25ppm, 1/8W, 1206	MC005813	Resistor, Thin Film, 3K4, 0.1%, ±25ppm, 1/8W, 1206	MC005854
Resistor, Thin Film, 1K21, 0.1%, ±25ppm, 1/8W, 1206	MC005814	Resistor, Thin Film, 3K48, 0.1%, ±25ppm, 1/8W, 1206	MC005855
Resistor, Thin Film, 1K24, 0.1%, ±25ppm, 1/8W, 1206	MC005815	Resistor, Thin Film, 3K57, 0.1%, ±25ppm, 1/8W, 1206	MC005856
Resistor, Thin Film, 1K27, 0.1%, ±25ppm, 1/8W, 1206	MC005816	Resistor, Thin Film, 3K65, 0.1%, ±25ppm, 1/8W, 1206	MC005857
Resistor, Thin Film, 1K3, 0.1%, ±25ppm, 1/8W, 1206	MC005817	Resistor, Thin Film, 3K74, 0.1%, ±25ppm, 1/8W, 1206	MC005858
Resistor, Thin Film, 1K33, 0.1%, ±25ppm, 1/8W, 1206	MC005818	Resistor, Thin Film, 3K83, 0.1%, ±25ppm, 1/8W, 1206	MC005859
Resistor, Thin Film, 1K37, 0.1%, ±25ppm, 1/8W, 1206	MC005819	Resistor, Thin Film, 3K92, 0.1%, ±25ppm, 1/8W, 1206	MC005860
Resistor, Thin Film, 1K4, 0.1%, ±25ppm, 1/8W, 1206	MC005820	Resistor, Thin Film, 4K02, 0.1%, ±25ppm, 1/8W, 1206	MC005861
Resistor, Thin Film, 1K43, 0.1%, ±25ppm, 1/8W, 1206	MC005821	Resistor, Thin Film, 4K12, 0.1%, ±25ppm, 1/8W, 1206	MC005862
Resistor, Thin Film, 1K47, 0.1%, ±25ppm, 1/8W, 1206	MC005822	Resistor, Thin Film, 4K22, 0.1%, ±25ppm, 1/8W, 1206	MC005863
Resistor, Thin Film, 1K5, 0.1%, ±25ppm, 1/8W, 1206	MC005823	Resistor, Thin Film, 4K32, 0.1%, ±25ppm, 1/8W, 1206	MC005864
Resistor, Thin Film, 1K54, 0.1%, ±25ppm, 1/8W, 1206	MC005824	Resistor, Thin Film, 4K42, 0.1%, ±25ppm, 1/8W, 1206	MC005865
Resistor, Thin Film, 1K58, 0.1%, ±25ppm, 1/8W, 1206	MC005825	Resistor, Thin Film, 4K53, 0.1%, ±25ppm, 1/8W, 1206	MC005866
Resistor, Thin Film, 1K62, 0.1%, ±25ppm, 1/8W, 1206	MC005826	Resistor, Thin Film, 4K64, 0.1%, ±25ppm, 1/8W, 1206	MC005867
Resistor, Thin Film, 1K65, 0.1%, ±25ppm, 1/8W, 1206	MC005827	Resistor, Thin Film, 4K75, 0.1%, ±25ppm, 1/8W, 1206	MC005868
Resistor, Thin Film, 1K69, 0.1%, ±25ppm, 1/8W, 1206	MC005828	Resistor, Thin Film, 4K87, 0.1%, ±25ppm, 1/8W, 1206	MC005869
Resistor, Thin Film, 1K74, 0.1%, ±25ppm, 1/8W, 1206	MC005829	Resistor, Thin Film, 4K99, 0.1%, ±25ppm, 1/8W, 1206	MC005870
Resistor, Thin Film, 1K78, 0.1%, ±25ppm, 1/8W, 1206	MC005830	Resistor, Thin Film, 5K11, 0.1%, ±25ppm, 1/8W, 1206	MC005871
Resistor, Thin Film, 1K82, 0.1%, ±25ppm, 1/8W, 1206	MC005831	Resistor, Thin Film, 5K23, 0.1%, ±25ppm, 1/8W, 1206	MC005872
Resistor, Thin Film, 1K87, 0.1%, ±25ppm, 1/8W, 1206	MC005832	Resistor, Thin Film, 5K36, 0.1%, ±25ppm, 1/8W, 1206	MC005873
Resistor, Thin Film, 1K91, 0.1%, ±25ppm, 1/8W, 1206	MC005833	Resistor, Thin Film, 5K49, 0.1%, ±25ppm, 1/8W, 1206	MC005874
Resistor, Thin Film, 1K96, 0.1%, ±25ppm, 1/8W, 1206	MC005834	Resistor, Thin Film, 5K62, 0.1%, ±25ppm, 1/8W, 1206	MC005875

www.element14.com
www.farnell.com
www.newark.com



Thin Film Precision Chip Resistor

Description	Part Number	Description	Part Number
Resistor, Thin Film, 5K76, 0.1%, ±25ppm, 1/8W, 1206	MC005876	Resistor, Thin Film, 15K4, 0.1%, ±25ppm, 1/8W, 1206	MC005917
Resistor, Thin Film, 5K9, 0.1%, ±25ppm, 1/8W, 1206	MC005877	Resistor, Thin Film, 15K8, 0.1%, ±25ppm, 1/8W, 1206	MC005918
Resistor, Thin Film, 6K04, 0.1%, ±25ppm, 1/8W, 1206	MC005878	Resistor, Thin Film, 16K2, 0.1%, ±25ppm, 1/8W, 1206	MC005919
Resistor, Thin Film, 6K19, 0.1%, ±25ppm, 1/8W, 1206	MC005879	Resistor, Thin Film, 16K5, 0.1%, ±25ppm, 1/8W, 1206	MC005920
Resistor, Thin Film, 6K34, 0.1%, ±25ppm, 1/8W, 1206	MC005880	Resistor, Thin Film, 16K9, 0.1%, ±25ppm, 1/8W, 1206	MC005921
Resistor, Thin Film, 6K49, 0.1%, ±25ppm, 1/8W, 1206	MC005881	Resistor, Thin Film, 17K4, 0.1%, ±25ppm, 1/8W, 1206	MC005922
Resistor, Thin Film, 6K65, 0.1%, ±25ppm, 1/8W, 1206	MC005882	Resistor, Thin Film, 17K8, 0.1%, ±25ppm, 1/8W, 1206	MC005923
Resistor, Thin Film, 6K81, 0.1%, ±25ppm, 1/8W, 1206	MC005883	Resistor, Thin Film, 18K2, 0.1%, ±25ppm, 1/8W, 1206	MC005924
Resistor, Thin Film, 6K98, 0.1%, ±25ppm, 1/8W, 1206	MC005884	Resistor, Thin Film, 18K7, 0.1%, ±25ppm, 1/8W, 1206	MC005925
Resistor, Thin Film, 7K15, 0.1%, ±25ppm, 1/8W, 1206	MC005885	Resistor, Thin Film, 19K1, 0.1%, ±25ppm, 1/8W, 1206	MC005926
Resistor, Thin Film, 7K32, 0.1%, ±25ppm, 1/8W, 1206	MC005886	Resistor, Thin Film, 19K6, 0.1%, ±25ppm, 1/8W, 1206	MC005927
Resistor, Thin Film, 7K5, 0.1%, ±25ppm, 1/8W, 1206	MC005887	Resistor, Thin Film, 20K, 0.1%, ±25ppm, 1/8W, 1206	MC005928
Resistor, Thin Film, 7K68, 0.1%, ±25ppm, 1/8W, 1206	MC005888	Resistor, Thin Film, 20K5, 0.1%, ±25ppm, 1/8W, 1206	MC005929
Resistor, Thin Film, 7K87, 0.1%, ±25ppm, 1/8W, 1206	MC005889	Resistor, Thin Film, 21K, 0.1%, ±25ppm, 1/8W, 1206	MC005930
Resistor, Thin Film, 8K06, 0.1%, ±25ppm, 1/8W, 1206	MC005890	Resistor, Thin Film, 21K5, 0.1%, ±25ppm, 1/8W, 1206	MC005931
Resistor, Thin Film, 8K25, 0.1%, ±25ppm, 1/8W, 1206	MC005891	Resistor, Thin Film, 22K1, 0.1%, ±25ppm, 1/8W, 1206	MC005932
Resistor, Thin Film, 8K45, 0.1%, ±25ppm, 1/8W, 1206	MC005892	Resistor, Thin Film, 22K6, 0.1%, ±25ppm, 1/8W, 1206	MC005933
Resistor, Thin Film, 8K66, 0.1%, ±25ppm, 1/8W, 1206	MC005893	Resistor, Thin Film, 23K2, 0.1%, ±25ppm, 1/8W, 1206	MC005934
Resistor, Thin Film, 8K87, 0.1%, ±25ppm, 1/8W, 1206	MC005894	Resistor, Thin Film, 23K7, 0.1%, ±25ppm, 1/8W, 1206	MC005935
Resistor, Thin Film, 9K09, 0.1%, ±25ppm, 1/8W, 1206	MC005895	Resistor, Thin Film, 24K3, 0.1%, ±25ppm, 1/8W, 1206	MC005936
Resistor, Thin Film, 9K31, 0.1%, ±25ppm, 1/8W, 1206	MC005896	Resistor, Thin Film, 24K9, 0.1%, ±25ppm, 1/8W, 1206	MC005937
Resistor, Thin Film, 9K53, 0.1%, ±25ppm, 1/8W, 1206	MC005897	Resistor, Thin Film, 25K5, 0.1%, ±25ppm, 1/8W, 1206	MC005938
Resistor, Thin Film, 9K76, 0.1%, ±25ppm, 1/8W, 1206	MC005898	Resistor, Thin Film, 26K1, 0.1%, ±25ppm, 1/8W, 1206	MC005939
Resistor, Thin Film, 10K, 0.1%, ±25ppm, 1/8W, 1206	MC005899	Resistor, Thin Film, 26K7, 0.1%, ±25ppm, 1/8W, 1206	MC005940
Resistor, Thin Film, 10K2, 0.1%, ±25ppm, 1/8W, 1206	MC005900	Resistor, Thin Film, 27K4, 0.1%, ±25ppm, 1/8W, 1206	MC005941
Resistor, Thin Film, 10K5, 0.1%, ±25ppm, 1/8W, 1206	MC005901	Resistor, Thin Film, 28K, 0.1%, ±25ppm, 1/8W, 1206	MC005942
Resistor, Thin Film, 10K7, 0.1%, ±25ppm, 1/8W, 1206	MC005902	Resistor, Thin Film, 29K4, 0.1%, ±25ppm, 1/8W, 1206	MC005943
Resistor, Thin Film, 11K, 0.1%, ±25ppm, 1/8W, 1206	MC005903	Resistor, Thin Film, 31K6, 0.1%, ±25ppm, 1/8W, 1206	MC005944
Resistor, Thin Film, 11K3, 0.1%, ±25ppm, 1/8W, 1206	MC005904	Resistor, Thin Film, 32K4, 0.1%, ±25ppm, 1/8W, 1206	MC005945
Resistor, Thin Film, 11K5, 0.1%, ±25ppm, 1/8W, 1206	MC005905	Resistor, Thin Film, 33K2, 0.1%, ±25ppm, 1/8W, 1206	MC005946
Resistor, Thin Film, 11K8, 0.1%, ±25ppm, 1/8W, 1206	MC005906	Resistor, Thin Film, 34K, 0.1%, ±25ppm, 1/8W, 1206	MC005947
Resistor, Thin Film, 12K1, 0.1%, ±25ppm, 1/8W, 1206	MC005907	Resistor, Thin Film, 34K8, 0.1%, ±25ppm, 1/8W, 1206	MC005948
Resistor, Thin Film, 12K4, 0.1%, ±25ppm, 1/8W, 1206	MC005908	Resistor, Thin Film, 35K7, 0.1%, ±25ppm, 1/8W, 1206	MC005949
Resistor, Thin Film, 12K7, 0.1%, ±25ppm, 1/8W, 1206	MC005909	Resistor, Thin Film, 36K5, 0.1%, ±25ppm, 1/8W, 1206	MC005950
Resistor, Thin Film, 13K, 0.1%, ±25ppm, 1/8W, 1206	MC005910	Resistor, Thin Film, 37K4, 0.1%, ±25ppm, 1/8W, 1206	MC005951
Resistor, Thin Film, 13K3, 0.1%, ±25ppm, 1/8W, 1206	MC005911	Resistor, Thin Film, 38K3, 0.1%, ±25ppm, 1/8W, 1206	MC005952
Resistor, Thin Film, 13K7, 0.1%, ±25ppm, 1/8W, 1206	MC005912	Resistor, Thin Film, 39K2, 0.1%, ±25ppm, 1/8W, 1206	MC005953
Resistor, Thin Film, 14K, 0.1%, ±25ppm, 1/8W, 1206	MC005913	Resistor, Thin Film, 40K2, 0.1%, ±25ppm, 1/8W, 1206	MC005954
Resistor, Thin Film, 14K3, 0.1%, ±25ppm, 1/8W, 1206	MC005914	Resistor, Thin Film, 41K2, 0.1%, ±25ppm, 1/8W, 1206	MC005955
Resistor, Thin Film, 14K7, 0.1%, ±25ppm, 1/8W, 1206	MC005915	Resistor, Thin Film, 42K2, 0.1%, ±25ppm, 1/8W, 1206	MC005956
Resistor, Thin Film, 15K, 0.1%, ±25ppm, 1/8W, 1206	MC005916	Resistor, Thin Film, 43K2, 0.1%, ±25ppm, 1/8W, 1206	MC005957

www.element14.com
www.farnell.com
www.newark.com



Thin Film Precision Chip Resistor

Description	Part Number	Description	Part Number
Resistor, Thin Film, 44K2, 0.1%, ±25ppm, 1/8W, 1206	MC005958	Resistor, Thin Film, 118K, 0.1%, ±25ppm, 1/8W, 1206	MC005999
Resistor, Thin Film, 45K3, 0.1%, ±25ppm, 1/8W, 1206	MC005959	Resistor, Thin Film, 121K, 0.1%, ±25ppm, 1/8W, 1206	MC006000
Resistor, Thin Film, 46K4, 0.1%, ±25ppm, 1/8W, 1206	MC005960	Resistor, Thin Film, 124K, 0.1%, ±25ppm, 1/8W, 1206	MC006001
Resistor, Thin Film, 47K5, 0.1%, ±25ppm, 1/8W, 1206	MC005961	Resistor, Thin Film, 127K, 0.1%, ±25ppm, 1/8W, 1206	MC006002
Resistor, Thin Film, 48K7, 0.1%, ±25ppm, 1/8W, 1206	MC005962	Resistor, Thin Film, 130K, 0.1%, ±25ppm, 1/8W, 1206	MC006003
Resistor, Thin Film, 49K9, 0.1%, ±25ppm, 1/8W, 1206	MC005963	Resistor, Thin Film, 133K, 0.1%, ±25ppm, 1/8W, 1206	MC006004
Resistor, Thin Film, 51K1, 0.1%, ±25ppm, 1/8W, 1206	MC005964	Resistor, Thin Film, 137K, 0.1%, ±25ppm, 1/8W, 1206	MC006005
Resistor, Thin Film, 52K3, 0.1%, ±25ppm, 1/8W, 1206	MC005965	Resistor, Thin Film, 140K, 0.1%, ±25ppm, 1/8W, 1206	MC006006
Resistor, Thin Film, 53K6, 0.1%, ±25ppm, 1/8W, 1206	MC005966	Resistor, Thin Film, 143K, 0.1%, ±25ppm, 1/8W, 1206	MC006007
Resistor, Thin Film, 54K9, 0.1%, ±25ppm, 1/8W, 1206	MC005967	Resistor, Thin Film, 147K, 0.1%, ±25ppm, 1/8W, 1206	MC006008
Resistor, Thin Film, 56K2, 0.1%, ±25ppm, 1/8W, 1206	MC005968	Resistor, Thin Film, 150K, 0.1%, ±25ppm, 1/8W, 1206	MC006009
Resistor, Thin Film, 57K6, 0.1%, ±25ppm, 1/8W, 1206	MC005969	Resistor, Thin Film, 154K, 0.1%, ±25ppm, 1/8W, 1206	MC006010
Resistor, Thin Film, 59K, 0.1%, ±25ppm, 1/8W, 1206	MC005970	Resistor, Thin Film, 158K, 0.1%, ±25ppm, 1/8W, 1206	MC006011
Resistor, Thin Film, 60K4, 0.1%, ±25ppm, 1/8W, 1206	MC005971	Resistor, Thin Film, 162K, 0.1%, ±25ppm, 1/8W, 1206	MC006012
Resistor, Thin Film, 61K9, 0.1%, ±25ppm, 1/8W, 1206	MC005972	Resistor, Thin Film, 165K, 0.1%, ±25ppm, 1/8W, 1206	MC006013
Resistor, Thin Film, 63K4, 0.1%, ±25ppm, 1/8W, 1206	MC005973	Resistor, Thin Film, 169K, 0.1%, ±25ppm, 1/8W, 1206	MC006014
Resistor, Thin Film, 64K9, 0.1%, ±25ppm, 1/8W, 1206	MC005974	Resistor, Thin Film, 174K, 0.1%, ±25ppm, 1/8W, 1206	MC006015
Resistor, Thin Film, 66K5, 0.1%, ±25ppm, 1/8W, 1206	MC005975	Resistor, Thin Film, 178K, 0.1%, ±25ppm, 1/8W, 1206	MC006016
Resistor, Thin Film, 68K1, 0.1%, ±25ppm, 1/8W, 1206	MC005976	Resistor, Thin Film, 182K, 0.1%, ±25ppm, 1/8W, 1206	MC006017
Resistor, Thin Film, 69K8, 0.1%, ±25ppm, 1/8W, 1206	MC005977	Resistor, Thin Film, 187K, 0.1%, ±25ppm, 1/8W, 1206	MC006018
Resistor, Thin Film, 71K5, 0.1%, ±25ppm, 1/8W, 1206	MC005978	Resistor, Thin Film, 191K, 0.1%, ±25ppm, 1/8W, 1206	MC006019
Resistor, Thin Film, 73K2, 0.1%, ±25ppm, 1/8W, 1206	MC005979	Resistor, Thin Film, 196K, 0.1%, ±25ppm, 1/8W, 1206	MC006020
Resistor, Thin Film, 75K, 0.1%, ±25ppm, 1/8W, 1206	MC005980	Resistor, Thin Film, 200K, 0.1%, ±25ppm, 1/8W, 1206	MC006021
Resistor, Thin Film, 76K8, 0.1%, ±25ppm, 1/8W, 1206	MC005981	Resistor, Thin Film, 205K, 0.1%, ±25ppm, 1/8W, 1206	MC006022
Resistor, Thin Film, 78K7, 0.1%, ±25ppm, 1/8W, 1206	MC005982	Resistor, Thin Film, 210K, 0.1%, ±25ppm, 1/8W, 1206	MC006023
Resistor, Thin Film, 80K6, 0.1%, ±25ppm, 1/8W, 1206	MC005983	Resistor, Thin Film, 215K, 0.1%, ±25ppm, 1/8W, 1206	MC006024
Resistor, Thin Film, 82K5, 0.1%, ±25ppm, 1/8W, 1206	MC005984	Resistor, Thin Film, 221K, 0.1%, ±25ppm, 1/8W, 1206	MC006025
Resistor, Thin Film, 84K5, 0.1%, ±25ppm, 1/8W, 1206	MC005985	Resistor, Thin Film, 226K, 0.1%, ±25ppm, 1/8W, 1206	MC006026
Resistor, Thin Film, 86K6, 0.1%, ±25ppm, 1/8W, 1206	MC005986	Resistor, Thin Film, 232K, 0.1%, ±25ppm, 1/8W, 1206	MC006027
Resistor, Thin Film, 88K7, 0.1%, ±25ppm, 1/8W, 1206	MC005987	Resistor, Thin Film, 237K, 0.1%, ±25ppm, 1/8W, 1206	MC006028
Resistor, Thin Film, 90K9, 0.1%, ±25ppm, 1/8W, 1206	MC005988	Resistor, Thin Film, 243K, 0.1%, ±25ppm, 1/8W, 1206	MC006029
Resistor, Thin Film, 93K1, 0.1%, ±25ppm, 1/8W, 1206	MC005989	Resistor, Thin Film, 249K, 0.1%, ±25ppm, 1/8W, 1206	MC006030
Resistor, Thin Film, 95K3, 0.1%, ±25ppm, 1/8W, 1206	MC005990	Resistor, Thin Film, 255K, 0.1%, ±25ppm, 1/8W, 1206	MC006031
Resistor, Thin Film, 97K6, 0.1%, ±25ppm, 1/8W, 1206	MC005991	Resistor, Thin Film, 261K, 0.1%, ±25ppm, 1/8W, 1206	MC006032
Resistor, Thin Film, 100K, 0.1%, ±25ppm, 1/8W, 1206	MC005992	Resistor, Thin Film, 267K, 0.1%, ±25ppm, 1/8W, 1206	MC006033
Resistor, Thin Film, 102K, 0.1%, ±25ppm, 1/8W, 1206	MC005993	Resistor, Thin Film, 274K, 0.1%, ±25ppm, 1/8W, 1206	MC006034
Resistor, Thin Film, 105K, 0.1%, ±25ppm, 1/8W, 1206	MC005994	Resistor, Thin Film, 280K, 0.1%, ±25ppm, 1/8W, 1206	MC006035
Resistor, Thin Film, 107K, 0.1%, ±25ppm, 1/8W, 1206	MC005995	Resistor, Thin Film, 294K, 0.1%, ±25ppm, 1/8W, 1206	MC006036
Resistor, Thin Film, 110K, 0.1%, ±25ppm, 1/8W, 1206	MC005996	Resistor, Thin Film, 316K, 0.1%, ±25ppm, 1/8W, 1206	MC006037
Resistor, Thin Film, 113K, 0.1%, ±25ppm, 1/8W, 1206	MC005997	Resistor, Thin Film, 324K, 0.1%, ±25ppm, 1/8W, 1206	MC006038
Resistor, Thin Film, 115K, 0.1%, ±25ppm, 1/8W, 1206	MC005998	Resistor, Thin Film, 332K, 0.1%, ±25ppm, 1/8W, 1206	MC006039

www.element14.com
www.farnell.com
www.newark.com



Thin Film Precision Chip Resistor

Description	Part Number	Description	Part Number
Resistor, Thin Film, 340K, 0.1%, ±25ppm, 1/8W, 1206	MC006040	Resistor, Thin Film, 909K, 0.1%, ±25ppm, 1/8W, 1206	MC006081
Resistor, Thin Film, 348K, 0.1%, ±25ppm, 1/8W, 1206	MC006041	Resistor, Thin Film, 931K, 0.1%, ±25ppm, 1/8W, 1206	MC006082
Resistor, Thin Film, 357K, 0.1%, ±25ppm, 1/8W, 1206	MC006042	Resistor, Thin Film, 953K, 0.1%, ±25ppm, 1/8W, 1206	MC006083
Resistor, Thin Film, 365K, 0.1%, ±25ppm, 1/8W, 1206	MC006043	Resistor, Thin Film, 976K, 0.1%, ±25ppm, 1/8W, 1206	MC006084
Resistor, Thin Film, 374K, 0.1%, ±25ppm, 1/8W, 1206	MC006044	Resistor, Thin Film, 1M, 0.1%, ±25ppm, 1/8W, 1206	MC006085
Resistor, Thin Film, 383K, 0.1%, ±25ppm, 1/8W, 1206	MC006045	Resistor, Thin Film, 1M1, 0.1%, ±25ppm, 1/8W, 1206	MC006086
Resistor, Thin Film, 392K, 0.1%, ±25ppm, 1/8W, 1206	MC006046	Resistor, Thin Film, 1M2, 0.1%, ±25ppm, 1/8W, 1206	MC006087
Resistor, Thin Film, 402K, 0.1%, ±25ppm, 1/8W, 1206	MC006047	Resistor, Thin Film, 1M3, 0.1%, ±25ppm, 1/8W, 1206	MC006088
Resistor, Thin Film, 412K, 0.1%, ±25ppm, 1/8W, 1206	MC006048	Resistor, Thin Film, 1M5, 0.1%, ±25ppm, 1/8W, 1206	MC006089
Resistor, Thin Film, 422K, 0.1%, ±25ppm, 1/8W, 1206	MC006049	Resistor, Thin Film, 1M6, 0.1%, ±25ppm, 1/8W, 1206	MC006090
Resistor, Thin Film, 432K, 0.1%, ±25ppm, 1/8W, 1206	MC006050	Resistor, Thin Film, 1M8, 0.1%, ±25ppm, 1/8W, 1206	MC006091
Resistor, Thin Film, 442K, 0.1%, ±25ppm, 1/8W, 1206	MC006051	Resistor, Thin Film, 2M, 0.1%, ±25ppm, 1/8W, 1206	MC006092
Resistor, Thin Film, 453K, 0.1%, ±25ppm, 1/8W, 1206	MC006052	Resistor, Thin Film, 2M4, 0.1%, ±25ppm, 1/8W, 1206	MC006093
Resistor, Thin Film, 464K, 0.1%, ±25ppm, 1/8W, 1206	MC006053	Resistor, Thin Film, 2M49, 0.1%, ±25ppm, 1/8W, 1206	MC006094
Resistor, Thin Film, 475K, 0.1%, ±25ppm, 1/8W, 1206	MC006054	Resistor, Thin Film, 4R7, 0.1%, ±25ppm, 1/4W, 1210	MC006095
Resistor, Thin Film, 487K, 0.1%, ±25ppm, 1/8W, 1206	MC006055	Resistor, Thin Film, 5R1, 0.1%, ±25ppm, 1/4W, 1210	MC006096
Resistor, Thin Film, 499K, 0.1%, ±25ppm, 1/8W, 1206	MC006056	Resistor, Thin Film, 5R6, 0.1%, ±25ppm, 1/4W, 1210	MC006097
Resistor, Thin Film, 511K, 0.1%, ±25ppm, 1/8W, 1206	MC006057	Resistor, Thin Film, 6R2, 0.1%, ±25ppm, 1/4W, 1210	MC006098
Resistor, Thin Film, 523K, 0.1%, ±25ppm, 1/8W, 1206	MC006058	Resistor, Thin Film, 6R8, 0.1%, ±25ppm, 1/4W, 1210	MC006099
Resistor, Thin Film, 536K, 0.1%, ±25ppm, 1/8W, 1206	MC006059	Resistor, Thin Film, 7R5, 0.1%, ±25ppm, 1/4W, 1210	MC006100
Resistor, Thin Film, 549K, 0.1%, ±25ppm, 1/8W, 1206	MC006060	Resistor, Thin Film, 8R2, 0.1%, ±25ppm, 1/4W, 1210	MC006101
Resistor, Thin Film, 562K, 0.1%, ±25ppm, 1/8W, 1206	MC006061	Resistor, Thin Film, 9R1, 0.1%, ±25ppm, 1/4W, 1210	MC006102
Resistor, Thin Film, 576K, 0.1%, ±25ppm, 1/8W, 1206	MC006062	Resistor, Thin Film, 10R, 0.1%, ±25ppm, 1/4W, 1210	MC006103
Resistor, Thin Film, 590K, 0.1%, ±25ppm, 1/8W, 1206	MC006063	Resistor, Thin Film, 10R2, 0.1%, ±25ppm, 1/4W, 1210	MC006104
Resistor, Thin Film, 604K, 0.1%, ±25ppm, 1/8W, 1206	MC006064	Resistor, Thin Film, 10R5, 0.1%, ±25ppm, 1/4W, 1210	MC006105
Resistor, Thin Film, 619K, 0.1%, ±25ppm, 1/8W, 1206	MC006065	Resistor, Thin Film, 10R7, 0.1%, ±25ppm, 1/4W, 1210	MC006106
Resistor, Thin Film, 634K, 0.1%, ±25ppm, 1/8W, 1206	MC006066	Resistor, Thin Film, 11R, 0.1%, ±25ppm, 1/4W, 1210	MC006107
Resistor, Thin Film, 649K, 0.1%, ±25ppm, 1/8W, 1206	MC006067	Resistor, Thin Film, 11R3, 0.1%, ±25ppm, 1/4W, 1210	MC006108
Resistor, Thin Film, 665K, 0.1%, ±25ppm, 1/8W, 1206	MC006068	Resistor, Thin Film, 11R5, 0.1%, ±25ppm, 1/4W, 1210	MC006109
Resistor, Thin Film, 681K, 0.1%, ±25ppm, 1/8W, 1206	MC006069	Resistor, Thin Film, 11R8, 0.1%, ±25ppm, 1/4W, 1210	MC006110
Resistor, Thin Film, 698K, 0.1%, ±25ppm, 1/8W, 1206	MC006070	Resistor, Thin Film, 12R1, 0.1%, ±25ppm, 1/4W, 1210	MC006111
Resistor, Thin Film, 715K, 0.1%, ±25ppm, 1/8W, 1206	MC006071	Resistor, Thin Film, 12R4, 0.1%, ±25ppm, 1/4W, 1210	MC006112
Resistor, Thin Film, 732K, 0.1%, ±25ppm, 1/8W, 1206	MC006072	Resistor, Thin Film, 12R7, 0.1%, ±25ppm, 1/4W, 1210	MC006113
Resistor, Thin Film, 750K, 0.1%, ±25ppm, 1/8W, 1206	MC006073	Resistor, Thin Film, 13R, 0.1%, ±25ppm, 1/4W, 1210	MC006114
Resistor, Thin Film, 768K, 0.1%, ±25ppm, 1/8W, 1206	MC006074	Resistor, Thin Film, 13R3, 0.1%, ±25ppm, 1/4W, 1210	MC006115
Resistor, Thin Film, 787K, 0.1%, ±25ppm, 1/8W, 1206	MC006075	Resistor, Thin Film, 13R7, 0.1%, ±25ppm, 1/4W, 1210	MC006116
Resistor, Thin Film, 806K, 0.1%, ±25ppm, 1/8W, 1206	MC006076	Resistor, Thin Film, 14R, 0.1%, ±25ppm, 1/4W, 1210	MC006117
Resistor, Thin Film, 825K, 0.1%, ±25ppm, 1/8W, 1206	MC006077	Resistor, Thin Film, 14R3, 0.1%, ±25ppm, 1/4W, 1210	MC006118
Resistor, Thin Film, 845K, 0.1%, ±25ppm, 1/8W, 1206	MC006078	Resistor, Thin Film, 14R7, 0.1%, ±25ppm, 1/4W, 1210	MC006119
Resistor, Thin Film, 866K, 0.1%, ±25ppm, 1/8W, 1206	MC006079	Resistor, Thin Film, 15R, 0.1%, ±25ppm, 1/4W, 1210	MC006120
Resistor, Thin Film, 887K, 0.1%, ±25ppm, 1/8W, 1206	MC006080	Resistor, Thin Film, 15R4, 0.1%, ±25ppm, 1/4W, 1210	MC006121

www.element14.com
www.farnell.com
www.newark.com



Thin Film Precision Chip Resistor

Description	Part Number	Description	Part Number
Resistor, Thin Film, 15R8, 0.1%, ±25ppm, 1/4W, 1210	MC006122	Resistor, Thin Film, 45R3, 0.1%, ±25ppm, 1/4W, 1210	MC006163
Resistor, Thin Film, 16R2, 0.1%, ±25ppm, 1/4W, 1210	MC006123	Resistor, Thin Film, 46R4, 0.1%, ±25ppm, 1/4W, 1210	MC006164
Resistor, Thin Film, 16R5, 0.1%, ±25ppm, 1/4W, 1210	MC006124	Resistor, Thin Film, 47R5, 0.1%, ±25ppm, 1/4W, 1210	MC006165
Resistor, Thin Film, 16R9, 0.1%, ±25ppm, 1/4W, 1210	MC006125	Resistor, Thin Film, 48R7, 0.1%, ±25ppm, 1/4W, 1210	MC006166
Resistor, Thin Film, 17R4, 0.1%, ±25ppm, 1/4W, 1210	MC006126	Resistor, Thin Film, 49R9, 0.1%, ±25ppm, 1/4W, 1210	MC006167
Resistor, Thin Film, 17R8, 0.1%, ±25ppm, 1/4W, 1210	MC006127	Resistor, Thin Film, 51R1, 0.1%, ±25ppm, 1/4W, 1210	MC006168
Resistor, Thin Film, 18R2, 0.1%, ±25ppm, 1/4W, 1210	MC006128	Resistor, Thin Film, 52R3, 0.1%, ±25ppm, 1/4W, 1210	MC006169
Resistor, Thin Film, 18R7, 0.1%, ±25ppm, 1/4W, 1210	MC006129	Resistor, Thin Film, 53R6, 0.1%, ±25ppm, 1/4W, 1210	MC006170
Resistor, Thin Film, 19R1, 0.1%, ±25ppm, 1/4W, 1210	MC006130	Resistor, Thin Film, 54R9, 0.1%, ±25ppm, 1/4W, 1210	MC006171
Resistor, Thin Film, 19R6, 0.1%, ±25ppm, 1/4W, 1210	MC006131	Resistor, Thin Film, 56R2, 0.1%, ±25ppm, 1/4W, 1210	MC006172
Resistor, Thin Film, 20R, 0.1%, ±25ppm, 1/4W, 1210	MC006132	Resistor, Thin Film, 57R6, 0.1%, ±25ppm, 1/4W, 1210	MC006173
Resistor, Thin Film, 20R5, 0.1%, ±25ppm, 1/4W, 1210	MC006133	Resistor, Thin Film, 59R, 0.1%, ±25ppm, 1/4W, 1210	MC006174
Resistor, Thin Film, 21R, 0.1%, ±25ppm, 1/4W, 1210	MC006134	Resistor, Thin Film, 60R4, 0.1%, ±25ppm, 1/4W, 1210	MC006175
Resistor, Thin Film, 21R5, 0.1%, ±25ppm, 1/4W, 1210	MC006135	Resistor, Thin Film, 61R9, 0.1%, ±25ppm, 1/4W, 1210	MC006176
Resistor, Thin Film, 22R1, 0.1%, ±25ppm, 1/4W, 1210	MC006136	Resistor, Thin Film, 63R4, 0.1%, ±25ppm, 1/4W, 1210	MC006177
Resistor, Thin Film, 22R6, 0.1%, ±25ppm, 1/4W, 1210	MC006137	Resistor, Thin Film, 64R9, 0.1%, ±25ppm, 1/4W, 1210	MC006178
Resistor, Thin Film, 23R2, 0.1%, ±25ppm, 1/4W, 1210	MC006138	Resistor, Thin Film, 66R5, 0.1%, ±25ppm, 1/4W, 1210	MC006179
Resistor, Thin Film, 23R7, 0.1%, ±25ppm, 1/4W, 1210	MC006139	Resistor, Thin Film, 68R1, 0.1%, ±25ppm, 1/4W, 1210	MC006180
Resistor, Thin Film, 24R3, 0.1%, ±25ppm, 1/4W, 1210	MC006140	Resistor, Thin Film, 69R8, 0.1%, ±25ppm, 1/4W, 1210	MC006181
Resistor, Thin Film, 24R9, 0.1%, ±25ppm, 1/4W, 1210	MC006141	Resistor, Thin Film, 71R5, 0.1%, ±25ppm, 1/4W, 1210	MC006182
Resistor, Thin Film, 25R5, 0.1%, ±25ppm, 1/4W, 1210	MC006142	Resistor, Thin Film, 73R2, 0.1%, ±25ppm, 1/4W, 1210	MC006183
Resistor, Thin Film, 26R1, 0.1%, ±25ppm, 1/4W, 1210	MC006143	Resistor, Thin Film, 75R, 0.1%, ±25ppm, 1/4W, 1210	MC006184
Resistor, Thin Film, 26R7, 0.1%, ±25ppm, 1/4W, 1210	MC006144	Resistor, Thin Film, 76R8, 0.1%, ±25ppm, 1/4W, 1210	MC006185
Resistor, Thin Film, 27R4, 0.1%, ±25ppm, 1/4W, 1210	MC006145	Resistor, Thin Film, 78R7, 0.1%, ±25ppm, 1/4W, 1210	MC006186
Resistor, Thin Film, 28R, 0.1%, ±25ppm, 1/4W, 1210	MC006146	Resistor, Thin Film, 80R6, 0.1%, ±25ppm, 1/4W, 1210	MC006187
Resistor, Thin Film, 29R4, 0.1%, ±25ppm, 1/4W, 1210	MC006147	Resistor, Thin Film, 82R5, 0.1%, ±25ppm, 1/4W, 1210	MC006188
Resistor, Thin Film, 31R6, 0.1%, ±25ppm, 1/4W, 1210	MC006148	Resistor, Thin Film, 84R5, 0.1%, ±25ppm, 1/4W, 1210	MC006189
Resistor, Thin Film, 32R4, 0.1%, ±25ppm, 1/4W, 1210	MC006149	Resistor, Thin Film, 86R6, 0.1%, ±25ppm, 1/4W, 1210	MC006190
Resistor, Thin Film, 33R2, 0.1%, ±25ppm, 1/4W, 1210	MC006150	Resistor, Thin Film, 88R7, 0.1%, ±25ppm, 1/4W, 1210	MC006191
Resistor, Thin Film, 34R, 0.1%, ±25ppm, 1/4W, 1210	MC006151	Resistor, Thin Film, 90R9, 0.1%, ±25ppm, 1/4W, 1210	MC006192
Resistor, Thin Film, 34R8, 0.1%, ±25ppm, 1/4W, 1210	MC006152	Resistor, Thin Film, 93R1, 0.1%, ±25ppm, 1/4W, 1210	MC006193
Resistor, Thin Film, 35R7, 0.1%, ±25ppm, 1/4W, 1210	MC006153	Resistor, Thin Film, 95R3, 0.1%, ±25ppm, 1/4W, 1210	MC006194
Resistor, Thin Film, 36R5, 0.1%, ±25ppm, 1/4W, 1210	MC006154	Resistor, Thin Film, 97R6, 0.1%, ±25ppm, 1/4W, 1210	MC006195
Resistor, Thin Film, 37R4, 0.1%, ±25ppm, 1/4W, 1210	MC006155	Resistor, Thin Film, 100R, 0.1%, ±25ppm, 1/4W, 1210	MC006196
Resistor, Thin Film, 38R3, 0.1%, ±25ppm, 1/4W, 1210	MC006156	Resistor, Thin Film, 102R, 0.1%, ±25ppm, 1/4W, 1210	MC006197
Resistor, Thin Film, 39R2, 0.1%, ±25ppm, 1/4W, 1210	MC006157	Resistor, Thin Film, 105R, 0.1%, ±25ppm, 1/4W, 1210	MC006198
Resistor, Thin Film, 40R2, 0.1%, ±25ppm, 1/4W, 1210	MC006158	Resistor, Thin Film, 107R, 0.1%, ±25ppm, 1/4W, 1210	MC006199
Resistor, Thin Film, 41R2, 0.1%, ±25ppm, 1/4W, 1210	MC006159	Resistor, Thin Film, 110R, 0.1%, ±25ppm, 1/4W, 1210	MC006200
Resistor, Thin Film, 42R2, 0.1%, ±25ppm, 1/4W, 1210	MC006160	Resistor, Thin Film, 113R, 0.1%, ±25ppm, 1/4W, 1210	MC006201
Resistor, Thin Film, 43R2, 0.1%, ±25ppm, 1/4W, 1210	MC006161	Resistor, Thin Film, 115R, 0.1%, ±25ppm, 1/4W, 1210	MC006202
Resistor, Thin Film, 44R2, 0.1%, ±25ppm, 1/4W, 1210	MC006162	Resistor, Thin Film, 118R, 0.1%, ±25ppm, 1/4W, 1210	MC006203

www.element14.com
www.farnell.com
www.newark.com



Thin Film Precision Chip Resistor

Description	Part Number	Description	Part Number
Resistor, Thin Film, 931R, 0.1%, ±25ppm, 1/4W, 1210	MC006286	Resistor, Thin Film, 2K49, 0.1%, ±25ppm, 1/4W, 1210	MC006327
Resistor, Thin Film, 953R, 0.1%, ±25ppm, 1/4W, 1210	MC006287	Resistor, Thin Film, 2K55, 0.1%, ±25ppm, 1/4W, 1210	MC006328
Resistor, Thin Film, 976R, 0.1%, ±25ppm, 1/4W, 1210	MC006288	Resistor, Thin Film, 2K61, 0.1%, ±25ppm, 1/4W, 1210	MC006329
Resistor, Thin Film, 1K, 0.1%, ±25ppm, 1/4W, 1210	MC006289	Resistor, Thin Film, 2K67, 0.1%, ±25ppm, 1/4W, 1210	MC006330
Resistor, Thin Film, 1K02, 0.1%, ±25ppm, 1/4W, 1210	MC006290	Resistor, Thin Film, 2K74, 0.1%, ±25ppm, 1/4W, 1210	MC006331
Resistor, Thin Film, 1K05, 0.1%, ±25ppm, 1/4W, 1210	MC006291	Resistor, Thin Film, 2K8, 0.1%, ±25ppm, 1/4W, 1210	MC006332
Resistor, Thin Film, 1K07, 0.1%, ±25ppm, 1/4W, 1210	MC006292	Resistor, Thin Film, 2K94, 0.1%, ±25ppm, 1/4W, 1210	MC006333
Resistor, Thin Film, 1K1, 0.1%, ±25ppm, 1/4W, 1210	MC006293	Resistor, Thin Film, 3K16, 0.1%, ±25ppm, 1/4W, 1210	MC006334
Resistor, Thin Film, 1K13, 0.1%, ±25ppm, 1/4W, 1210	MC006294	Resistor, Thin Film, 3K24, 0.1%, ±25ppm, 1/4W, 1210	MC006335
Resistor, Thin Film, 1K15, 0.1%, ±25ppm, 1/4W, 1210	MC006295	Resistor, Thin Film, 3K32, 0.1%, ±25ppm, 1/4W, 1210	MC006336
Resistor, Thin Film, 1K18, 0.1%, ±25ppm, 1/4W, 1210	MC006296	Resistor, Thin Film, 3K4, 0.1%, ±25ppm, 1/4W, 1210	MC006337
Resistor, Thin Film, 1K21, 0.1%, ±25ppm, 1/4W, 1210	MC006297	Resistor, Thin Film, 3K48, 0.1%, ±25ppm, 1/4W, 1210	MC006338
Resistor, Thin Film, 1K24, 0.1%, ±25ppm, 1/4W, 1210	MC006298	Resistor, Thin Film, 3K57, 0.1%, ±25ppm, 1/4W, 1210	MC006339
Resistor, Thin Film, 1K27, 0.1%, ±25ppm, 1/4W, 1210	MC006299	Resistor, Thin Film, 3K65, 0.1%, ±25ppm, 1/4W, 1210	MC006340
Resistor, Thin Film, 1K3, 0.1%, ±25ppm, 1/4W, 1210	MC006300	Resistor, Thin Film, 3K74, 0.1%, ±25ppm, 1/4W, 1210	MC006341
Resistor, Thin Film, 1K33, 0.1%, ±25ppm, 1/4W, 1210	MC006301	Resistor, Thin Film, 3K83, 0.1%, ±25ppm, 1/4W, 1210	MC006342
Resistor, Thin Film, 1K37, 0.1%, ±25ppm, 1/4W, 1210	MC006302	Resistor, Thin Film, 3K92, 0.1%, ±25ppm, 1/4W, 1210	MC006343
Resistor, Thin Film, 1K4, 0.1%, ±25ppm, 1/4W, 1210	MC006303	Resistor, Thin Film, 4K02, 0.1%, ±25ppm, 1/4W, 1210	MC006344
Resistor, Thin Film, 1K43, 0.1%, ±25ppm, 1/4W, 1210	MC006304	Resistor, Thin Film, 4K12, 0.1%, ±25ppm, 1/4W, 1210	MC006345
Resistor, Thin Film, 1K47, 0.1%, ±25ppm, 1/4W, 1210	MC006305	Resistor, Thin Film, 4K22, 0.1%, ±25ppm, 1/4W, 1210	MC006346
Resistor, Thin Film, 1K5, 0.1%, ±25ppm, 1/4W, 1210	MC006306	Resistor, Thin Film, 4K32, 0.1%, ±25ppm, 1/4W, 1210	MC006347
Resistor, Thin Film, 1K54, 0.1%, ±25ppm, 1/4W, 1210	MC006307	Resistor, Thin Film, 4K42, 0.1%, ±25ppm, 1/4W, 1210	MC006348
Resistor, Thin Film, 1K58, 0.1%, ±25ppm, 1/4W, 1210	MC006308	Resistor, Thin Film, 4K53, 0.1%, ±25ppm, 1/4W, 1210	MC006349
Resistor, Thin Film, 1K62, 0.1%, ±25ppm, 1/4W, 1210	MC006309	Resistor, Thin Film, 4K64, 0.1%, ±25ppm, 1/4W, 1210	MC006350
Resistor, Thin Film, 1K65, 0.1%, ±25ppm, 1/4W, 1210	MC006310	Resistor, Thin Film, 4K75, 0.1%, ±25ppm, 1/4W, 1210	MC006351
Resistor, Thin Film, 1K69, 0.1%, ±25ppm, 1/4W, 1210	MC006311	Resistor, Thin Film, 4K87, 0.1%, ±25ppm, 1/4W, 1210	MC006352
Resistor, Thin Film, 1K74, 0.1%, ±25ppm, 1/4W, 1210	MC006312	Resistor, Thin Film, 4K99, 0.1%, ±25ppm, 1/4W, 1210	MC006353
Resistor, Thin Film, 1K78, 0.1%, ±25ppm, 1/4W, 1210	MC006313	Resistor, Thin Film, 5K11, 0.1%, ±25ppm, 1/4W, 1210	MC006354
Resistor, Thin Film, 1K82, 0.1%, ±25ppm, 1/4W, 1210	MC006314	Resistor, Thin Film, 5K23, 0.1%, ±25ppm, 1/4W, 1210	MC006355
Resistor, Thin Film, 1K87, 0.1%, ±25ppm, 1/4W, 1210	MC006315	Resistor, Thin Film, 5K36, 0.1%, ±25ppm, 1/4W, 1210	MC006356
Resistor, Thin Film, 1K91, 0.1%, ±25ppm, 1/4W, 1210	MC006316	Resistor, Thin Film, 5K49, 0.1%, ±25ppm, 1/4W, 1210	MC006357
Resistor, Thin Film, 1K96, 0.1%, ±25ppm, 1/4W, 1210	MC006317	Resistor, Thin Film, 5K62, 0.1%, ±25ppm, 1/4W, 1210	MC006358
Resistor, Thin Film, 2K, 0.1%, ±25ppm, 1/4W, 1210	MC006318	Resistor, Thin Film, 5K76, 0.1%, ±25ppm, 1/4W, 1210	MC006359
Resistor, Thin Film, 2K05, 0.1%, ±25ppm, 1/4W, 1210	MC006319	Resistor, Thin Film, 5K9, 0.1%, ±25ppm, 1/4W, 1210	MC006360
Resistor, Thin Film, 2K1, 0.1%, ±25ppm, 1/4W, 1210	MC006320	Resistor, Thin Film, 6K04, 0.1%, ±25ppm, 1/4W, 1210	MC006361
Resistor, Thin Film, 2K15, 0.1%, ±25ppm, 1/4W, 1210	MC006321	Resistor, Thin Film, 6K19, 0.1%, ±25ppm, 1/4W, 1210	MC006362
Resistor, Thin Film, 2K21, 0.1%, ±25ppm, 1/4W, 1210	MC006322	Resistor, Thin Film, 6K34, 0.1%, ±25ppm, 1/4W, 1210	MC006363
Resistor, Thin Film, 2K26, 0.1%, ±25ppm, 1/4W, 1210	MC006323	Resistor, Thin Film, 6K49, 0.1%, ±25ppm, 1/4W, 1210	MC006364
Resistor, Thin Film, 2K32, 0.1%, ±25ppm, 1/4W, 1210	MC006324	Resistor, Thin Film, 6K65, 0.1%, ±25ppm, 1/4W, 1210	MC006365
Resistor, Thin Film, 2K37, 0.1%, ±25ppm, 1/4W, 1210	MC006325	Resistor, Thin Film, 6K81, 0.1%, ±25ppm, 1/4W, 1210	MC006366
Resistor, Thin Film, 2K43, 0.1%, ±25ppm, 1/4W, 1210	MC006326	Resistor, Thin Film, 6K98, 0.1%, ±25ppm, 1/4W, 1210	MC006367

www.element14.com
www.farnell.com
www.newark.com



Thin Film Precision Chip Resistor

Description	Part Number	Description	Part Number
Resistor, Thin Film, 7K15, 0.1%, ±25ppm, 1/4W, 1210	MC006368	Resistor, Thin Film, 19K1, 0.1%, ±25ppm, 1/4W, 1210	MC006409
Resistor, Thin Film, 7K32, 0.1%, ±25ppm, 1/4W, 1210	MC006369	Resistor, Thin Film, 19K6, 0.1%, ±25ppm, 1/4W, 1210	MC006410
Resistor, Thin Film, 7K5, 0.1%, ±25ppm, 1/4W, 1210	MC006370	Resistor, Thin Film, 20K, 0.1%, ±25ppm, 1/4W, 1210	MC006411
Resistor, Thin Film, 7K68, 0.1%, ±25ppm, 1/4W, 1210	MC006371	Resistor, Thin Film, 20K5, 0.1%, ±25ppm, 1/4W, 1210	MC006412
Resistor, Thin Film, 7K87, 0.1%, ±25ppm, 1/4W, 1210	MC006372	Resistor, Thin Film, 21K, 0.1%, ±25ppm, 1/4W, 1210	MC006413
Resistor, Thin Film, 8K06, 0.1%, ±25ppm, 1/4W, 1210	MC006373	Resistor, Thin Film, 21K5, 0.1%, ±25ppm, 1/4W, 1210	MC006414
Resistor, Thin Film, 8K25, 0.1%, ±25ppm, 1/4W, 1210	MC006374	Resistor, Thin Film, 22K1, 0.1%, ±25ppm, 1/4W, 1210	MC006415
Resistor, Thin Film, 8K45, 0.1%, ±25ppm, 1/4W, 1210	MC006375	Resistor, Thin Film, 22K6, 0.1%, ±25ppm, 1/4W, 1210	MC006416
Resistor, Thin Film, 8K66, 0.1%, ±25ppm, 1/4W, 1210	MC006376	Resistor, Thin Film, 23K2, 0.1%, ±25ppm, 1/4W, 1210	MC006417
Resistor, Thin Film, 8K87, 0.1%, ±25ppm, 1/4W, 1210	MC006377	Resistor, Thin Film, 23K7, 0.1%, ±25ppm, 1/4W, 1210	MC006418
Resistor, Thin Film, 9K09, 0.1%, ±25ppm, 1/4W, 1210	MC006378	Resistor, Thin Film, 24K3, 0.1%, ±25ppm, 1/4W, 1210	MC006419
Resistor, Thin Film, 9K31, 0.1%, ±25ppm, 1/4W, 1210	MC006379	Resistor, Thin Film, 24K9, 0.1%, ±25ppm, 1/4W, 1210	MC006420
Resistor, Thin Film, 9K53, 0.1%, ±25ppm, 1/4W, 1210	MC006380	Resistor, Thin Film, 25K5, 0.1%, ±25ppm, 1/4W, 1210	MC006421
Resistor, Thin Film, 9K76, 0.1%, ±25ppm, 1/4W, 1210	MC006381	Resistor, Thin Film, 26K1, 0.1%, ±25ppm, 1/4W, 1210	MC006422
Resistor, Thin Film, 10K, 0.1%, ±25ppm, 1/4W, 1210	MC006382	Resistor, Thin Film, 26K7, 0.1%, ±25ppm, 1/4W, 1210	MC006423
Resistor, Thin Film, 10K2, 0.1%, ±25ppm, 1/4W, 1210	MC006383	Resistor, Thin Film, 27K4, 0.1%, ±25ppm, 1/4W, 1210	MC006424
Resistor, Thin Film, 10K5, 0.1%, ±25ppm, 1/4W, 1210	MC006384	Resistor, Thin Film, 28K, 0.1%, ±25ppm, 1/4W, 1210	MC006425
Resistor, Thin Film, 10K7, 0.1%, ±25ppm, 1/4W, 1210	MC006385	Resistor, Thin Film, 29K4, 0.1%, ±25ppm, 1/4W, 1210	MC006426
Resistor, Thin Film, 11K, 0.1%, ±25ppm, 1/4W, 1210	MC006386	Resistor, Thin Film, 31K6, 0.1%, ±25ppm, 1/4W, 1210	MC006427
Resistor, Thin Film, 11K3, 0.1%, ±25ppm, 1/4W, 1210	MC006387	Resistor, Thin Film, 32K4, 0.1%, ±25ppm, 1/4W, 1210	MC006428
Resistor, Thin Film, 11K5, 0.1%, ±25ppm, 1/4W, 1210	MC006388	Resistor, Thin Film, 33K2, 0.1%, ±25ppm, 1/4W, 1210	MC006429
Resistor, Thin Film, 11K8, 0.1%, ±25ppm, 1/4W, 1210	MC006389	Resistor, Thin Film, 34K, 0.1%, ±25ppm, 1/4W, 1210	MC006430
Resistor, Thin Film, 12K1, 0.1%, ±25ppm, 1/4W, 1210	MC006390	Resistor, Thin Film, 34K8, 0.1%, ±25ppm, 1/4W, 1210	MC006431
Resistor, Thin Film, 12K4, 0.1%, ±25ppm, 1/4W, 1210	MC006391	Resistor, Thin Film, 35K7, 0.1%, ±25ppm, 1/4W, 1210	MC006432
Resistor, Thin Film, 12K7, 0.1%, ±25ppm, 1/4W, 1210	MC006392	Resistor, Thin Film, 36K5, 0.1%, ±25ppm, 1/4W, 1210	MC006433
Resistor, Thin Film, 13K, 0.1%, ±25ppm, 1/4W, 1210	MC006393	Resistor, Thin Film, 37K4, 0.1%, ±25ppm, 1/4W, 1210	MC006434
Resistor, Thin Film, 13K3, 0.1%, ±25ppm, 1/4W, 1210	MC006394	Resistor, Thin Film, 38K3, 0.1%, ±25ppm, 1/4W, 1210	MC006435
Resistor, Thin Film, 13K7, 0.1%, ±25ppm, 1/4W, 1210	MC006395	Resistor, Thin Film, 39K2, 0.1%, ±25ppm, 1/4W, 1210	MC006436
Resistor, Thin Film, 14K, 0.1%, ±25ppm, 1/4W, 1210	MC006396	Resistor, Thin Film, 40K2, 0.1%, ±25ppm, 1/4W, 1210	MC006437
Resistor, Thin Film, 14K3, 0.1%, ±25ppm, 1/4W, 1210	MC006397	Resistor, Thin Film, 41K2, 0.1%, ±25ppm, 1/4W, 1210	MC006438
Resistor, Thin Film, 14K7, 0.1%, ±25ppm, 1/4W, 1210	MC006398	Resistor, Thin Film, 42K2, 0.1%, ±25ppm, 1/4W, 1210	MC006439
Resistor, Thin Film, 15K, 0.1%, ±25ppm, 1/4W, 1210	MC006399	Resistor, Thin Film, 43K2, 0.1%, ±25ppm, 1/4W, 1210	MC006440
Resistor, Thin Film, 15K4, 0.1%, ±25ppm, 1/4W, 1210	MC006400	Resistor, Thin Film, 44K2, 0.1%, ±25ppm, 1/4W, 1210	MC006441
Resistor, Thin Film, 15K8, 0.1%, ±25ppm, 1/4W, 1210	MC006401	Resistor, Thin Film, 45K3, 0.1%, ±25ppm, 1/4W, 1210	MC006442
Resistor, Thin Film, 16K2, 0.1%, ±25ppm, 1/4W, 1210	MC006402	Resistor, Thin Film, 46K4, 0.1%, ±25ppm, 1/4W, 1210	MC006443
Resistor, Thin Film, 16K5, 0.1%, ±25ppm, 1/4W, 1210	MC006403	Resistor, Thin Film, 47K5, 0.1%, ±25ppm, 1/4W, 1210	MC006444
Resistor, Thin Film, 16K9, 0.1%, ±25ppm, 1/4W, 1210	MC006404	Resistor, Thin Film, 48K7, 0.1%, ±25ppm, 1/4W, 1210	MC006445
Resistor, Thin Film, 17K4, 0.1%, ±25ppm, 1/4W, 1210	MC006405	Resistor, Thin Film, 49K9, 0.1%, ±25ppm, 1/4W, 1210	MC006446
Resistor, Thin Film, 17K8, 0.1%, ±25ppm, 1/4W, 1210	MC006406	Resistor, Thin Film, 51K1, 0.1%, ±25ppm, 1/4W, 1210	MC006447
Resistor, Thin Film, 18K2, 0.1%, ±25ppm, 1/4W, 1210	MC006407	Resistor, Thin Film, 52K3, 0.1%, ±25ppm, 1/4W, 1210	MC006448
Resistor, Thin Film, 18K7, 0.1%, ±25ppm, 1/4W, 1210	MC006408	Resistor, Thin Film, 53K6, 0.1%, ±25ppm, 1/4W, 1210	MC006449

www.element14.com
www.farnell.com
www.newark.com



Thin Film Precision Chip Resistor

Description	Part Number	Description	Part Number
Resistor, Thin Film, 54K9, 0.1%, ±25ppm, 1/4W, 1210	MC006450	Resistor, Thin Film, 147K, 0.1%, ±25ppm, 1/4W, 1210	MC006491
Resistor, Thin Film, 56K2, 0.1%, ±25ppm, 1/4W, 1210	MC006451	Resistor, Thin Film, 150K, 0.1%, ±25ppm, 1/4W, 1210	MC006492
Resistor, Thin Film, 57K6, 0.1%, ±25ppm, 1/4W, 1210	MC006452	Resistor, Thin Film, 154K, 0.1%, ±25ppm, 1/4W, 1210	MC006493
Resistor, Thin Film, 59K, 0.1%, ±25ppm, 1/4W, 1210	MC006453	Resistor, Thin Film, 158K, 0.1%, ±25ppm, 1/4W, 1210	MC006494
Resistor, Thin Film, 60K4, 0.1%, ±25ppm, 1/4W, 1210	MC006454	Resistor, Thin Film, 162K, 0.1%, ±25ppm, 1/4W, 1210	MC006495
Resistor, Thin Film, 61K9, 0.1%, ±25ppm, 1/4W, 1210	MC006455	Resistor, Thin Film, 165K, 0.1%, ±25ppm, 1/4W, 1210	MC006496
Resistor, Thin Film, 63K4, 0.1%, ±25ppm, 1/4W, 1210	MC006456	Resistor, Thin Film, 169K, 0.1%, ±25ppm, 1/4W, 1210	MC006497
Resistor, Thin Film, 64K9, 0.1%, ±25ppm, 1/4W, 1210	MC006457	Resistor, Thin Film, 174K, 0.1%, ±25ppm, 1/4W, 1210	MC006498
Resistor, Thin Film, 66K5, 0.1%, ±25ppm, 1/4W, 1210	MC006458	Resistor, Thin Film, 178K, 0.1%, ±25ppm, 1/4W, 1210	MC006499
Resistor, Thin Film, 68K1, 0.1%, ±25ppm, 1/4W, 1210	MC006459	Resistor, Thin Film, 182K, 0.1%, ±25ppm, 1/4W, 1210	MC006500
Resistor, Thin Film, 69K8, 0.1%, ±25ppm, 1/4W, 1210	MC006460	Resistor, Thin Film, 187K, 0.1%, ±25ppm, 1/4W, 1210	MC006501
Resistor, Thin Film, 71K5, 0.1%, ±25ppm, 1/4W, 1210	MC006461	Resistor, Thin Film, 191K, 0.1%, ±25ppm, 1/4W, 1210	MC006502
Resistor, Thin Film, 73K2, 0.1%, ±25ppm, 1/4W, 1210	MC006462	Resistor, Thin Film, 196K, 0.1%, ±25ppm, 1/4W, 1210	MC006503
Resistor, Thin Film, 75K, 0.1%, ±25ppm, 1/4W, 1210	MC006463	Resistor, Thin Film, 200K, 0.1%, ±25ppm, 1/4W, 1210	MC006504
Resistor, Thin Film, 76K8, 0.1%, ±25ppm, 1/4W, 1210	MC006464	Resistor, Thin Film, 205K, 0.1%, ±25ppm, 1/4W, 1210	MC006505
Resistor, Thin Film, 78K7, 0.1%, ±25ppm, 1/4W, 1210	MC006465	Resistor, Thin Film, 210K, 0.1%, ±25ppm, 1/4W, 1210	MC006506
Resistor, Thin Film, 80K6, 0.1%, ±25ppm, 1/4W, 1210	MC006466	Resistor, Thin Film, 215K, 0.1%, ±25ppm, 1/4W, 1210	MC006507
Resistor, Thin Film, 82K5, 0.1%, ±25ppm, 1/4W, 1210	MC006467	Resistor, Thin Film, 221K, 0.1%, ±25ppm, 1/4W, 1210	MC006508
Resistor, Thin Film, 84K5, 0.1%, ±25ppm, 1/4W, 1210	MC006468	Resistor, Thin Film, 226K, 0.1%, ±25ppm, 1/4W, 1210	MC006509
Resistor, Thin Film, 86K6, 0.1%, ±25ppm, 1/4W, 1210	MC006469	Resistor, Thin Film, 232K, 0.1%, ±25ppm, 1/4W, 1210	MC006510
Resistor, Thin Film, 88K7, 0.1%, ±25ppm, 1/4W, 1210	MC006470	Resistor, Thin Film, 237K, 0.1%, ±25ppm, 1/4W, 1210	MC006511
Resistor, Thin Film, 90K9, 0.1%, ±25ppm, 1/4W, 1210	MC006471	Resistor, Thin Film, 243K, 0.1%, ±25ppm, 1/4W, 1210	MC006512
Resistor, Thin Film, 93K1, 0.1%, ±25ppm, 1/4W, 1210	MC006472	Resistor, Thin Film, 249K, 0.1%, ±25ppm, 1/4W, 1210	MC006513
Resistor, Thin Film, 95K3, 0.1%, ±25ppm, 1/4W, 1210	MC006473	Resistor, Thin Film, 255K, 0.1%, ±25ppm, 1/4W, 1210	MC006514
Resistor, Thin Film, 97K6, 0.1%, ±25ppm, 1/4W, 1210	MC006474	Resistor, Thin Film, 261K, 0.1%, ±25ppm, 1/4W, 1210	MC006515
Resistor, Thin Film, 100K, 0.1%, ±25ppm, 1/4W, 1210	MC006475	Resistor, Thin Film, 267K, 0.1%, ±25ppm, 1/4W, 1210	MC006516
Resistor, Thin Film, 102K, 0.1%, ±25ppm, 1/4W, 1210	MC006476	Resistor, Thin Film, 274K, 0.1%, ±25ppm, 1/4W, 1210	MC006517
Resistor, Thin Film, 105K, 0.1%, ±25ppm, 1/4W, 1210	MC006477	Resistor, Thin Film, 280K, 0.1%, ±25ppm, 1/4W, 1210	MC006518
Resistor, Thin Film, 107K, 0.1%, ±25ppm, 1/4W, 1210	MC006478	Resistor, Thin Film, 294K, 0.1%, ±25ppm, 1/4W, 1210	MC006519
Resistor, Thin Film, 110K, 0.1%, ±25ppm, 1/4W, 1210	MC006479	Resistor, Thin Film, 316K, 0.1%, ±25ppm, 1/4W, 1210	MC006520
Resistor, Thin Film, 113K, 0.1%, ±25ppm, 1/4W, 1210	MC006480	Resistor, Thin Film, 324K, 0.1%, ±25ppm, 1/4W, 1210	MC006521
Resistor, Thin Film, 115K, 0.1%, ±25ppm, 1/4W, 1210	MC006481	Resistor, Thin Film, 332K, 0.1%, ±25ppm, 1/4W, 1210	MC006522
Resistor, Thin Film, 118K, 0.1%, ±25ppm, 1/4W, 1210	MC006482	Resistor, Thin Film, 340K, 0.1%, ±25ppm, 1/4W, 1210	MC006523
Resistor, Thin Film, 121K, 0.1%, ±25ppm, 1/4W, 1210	MC006483	Resistor, Thin Film, 348K, 0.1%, ±25ppm, 1/4W, 1210	MC006524
Resistor, Thin Film, 124K, 0.1%, ±25ppm, 1/4W, 1210	MC006484	Resistor, Thin Film, 357K, 0.1%, ±25ppm, 1/4W, 1210	MC006525
Resistor, Thin Film, 127K, 0.1%, ±25ppm, 1/4W, 1210	MC006485	Resistor, Thin Film, 365K, 0.1%, ±25ppm, 1/4W, 1210	MC006526
Resistor, Thin Film, 130K, 0.1%, ±25ppm, 1/4W, 1210	MC006486	Resistor, Thin Film, 374K, 0.1%, ±25ppm, 1/4W, 1210	MC006527
Resistor, Thin Film, 133K, 0.1%, ±25ppm, 1/4W, 1210	MC006487	Resistor, Thin Film, 383K, 0.1%, ±25ppm, 1/4W, 1210	MC006528
Resistor, Thin Film, 137K, 0.1%, ±25ppm, 1/4W, 1210	MC006488	Resistor, Thin Film, 392K, 0.1%, ±25ppm, 1/4W, 1210	MC006529
Resistor, Thin Film, 140K, 0.1%, ±25ppm, 1/4W, 1210	MC006489	Resistor, Thin Film, 402K, 0.1%, ±25ppm, 1/4W, 1210	MC006530
Resistor, Thin Film, 143K, 0.1%, ±25ppm, 1/4W, 1210	MC006490	Resistor, Thin Film, 412K, 0.1%, ±25ppm, 1/4W, 1210	MC006531

www.element14.com
www.farnell.com
www.newark.com



Thin Film Precision Chip Resistor

Description	Part Number	Description	Part Number
Resistor, Thin Film, 422K, 0.1%, ±25ppm, 1/4W, 1210	MC006532	Resistor, Thin Film, 1M6, 0.1%, ±25ppm, 1/4W, 1210	MC006573
Resistor, Thin Film, 432K, 0.1%, ±25ppm, 1/4W, 1210	MC006533	Resistor, Thin Film, 1M8, 0.1%, ±25ppm, 1/4W, 1210	MC006574
Resistor, Thin Film, 442K, 0.1%, ±25ppm, 1/4W, 1210	MC006534	Resistor, Thin Film, 2M, 0.1%, ±25ppm, 1/4W, 1210	MC006575
Resistor, Thin Film, 453K, 0.1%, ±25ppm, 1/4W, 1210	MC006535	Resistor, Thin Film, 2M4, 0.1%, ±25ppm, 1/4W, 1210	MC006576
Resistor, Thin Film, 464K, 0.1%, ±25ppm, 1/4W, 1210	MC006536	Resistor, Thin Film, 2M49, 0.1%, ±25ppm, 1/4W, 1210	MC006577
Resistor, Thin Film, 475K, 0.1%, ±25ppm, 1/4W, 1210	MC006537	Resistor, Thin Film, 4R7, 0.1%, ±25ppm, 1/4W, 2010	MC006578
Resistor, Thin Film, 487K, 0.1%, ±25ppm, 1/4W, 1210	MC006538	Resistor, Thin Film, 5R1, 0.1%, ±25ppm, 1/4W, 2010	MC006579
Resistor, Thin Film, 499K, 0.1%, ±25ppm, 1/4W, 1210	MC006539	Resistor, Thin Film, 5R6, 0.1%, ±25ppm, 1/4W, 2010	MC006580
Resistor, Thin Film, 511K, 0.1%, ±25ppm, 1/4W, 1210	MC006540	Resistor, Thin Film, 6R2, 0.1%, ±25ppm, 1/4W, 2010	MC006581
Resistor, Thin Film, 523K, 0.1%, ±25ppm, 1/4W, 1210	MC006541	Resistor, Thin Film, 6R8, 0.1%, ±25ppm, 1/4W, 2010	MC006582
Resistor, Thin Film, 536K, 0.1%, ±25ppm, 1/4W, 1210	MC006542	Resistor, Thin Film, 7R5, 0.1%, ±25ppm, 1/4W, 2010	MC006583
Resistor, Thin Film, 549K, 0.1%, ±25ppm, 1/4W, 1210	MC006543	Resistor, Thin Film, 8R2, 0.1%, ±25ppm, 1/4W, 2010	MC006584
Resistor, Thin Film, 562K, 0.1%, ±25ppm, 1/4W, 1210	MC006544	Resistor, Thin Film, 9R1, 0.1%, ±25ppm, 1/4W, 2010	MC006585
Resistor, Thin Film, 576K, 0.1%, ±25ppm, 1/4W, 1210	MC006545	Resistor, Thin Film, 10R, 0.1%, ±25ppm, 1/4W, 2010	MC006586
Resistor, Thin Film, 590K, 0.1%, ±25ppm, 1/4W, 1210	MC006546	Resistor, Thin Film, 10R2, 0.1%, ±25ppm, 1/4W, 2010	MC006587
Resistor, Thin Film, 604K, 0.1%, ±25ppm, 1/4W, 1210	MC006547	Resistor, Thin Film, 10R5, 0.1%, ±25ppm, 1/4W, 2010	MC006588
Resistor, Thin Film, 619K, 0.1%, ±25ppm, 1/4W, 1210	MC006548	Resistor, Thin Film, 10R7, 0.1%, ±25ppm, 1/4W, 2010	MC006589
Resistor, Thin Film, 634K, 0.1%, ±25ppm, 1/4W, 1210	MC006549	Resistor, Thin Film, 11R, 0.1%, ±25ppm, 1/4W, 2010	MC006590
Resistor, Thin Film, 649K, 0.1%, ±25ppm, 1/4W, 1210	MC006550	Resistor, Thin Film, 11R3, 0.1%, ±25ppm, 1/4W, 2010	MC006591
Resistor, Thin Film, 665K, 0.1%, ±25ppm, 1/4W, 1210	MC006551	Resistor, Thin Film, 11R5, 0.1%, ±25ppm, 1/4W, 2010	MC006592
Resistor, Thin Film, 681K, 0.1%, ±25ppm, 1/4W, 1210	MC006552	Resistor, Thin Film, 11R8, 0.1%, ±25ppm, 1/4W, 2010	MC006593
Resistor, Thin Film, 698K, 0.1%, ±25ppm, 1/4W, 1210	MC006553	Resistor, Thin Film, 12R1, 0.1%, ±25ppm, 1/4W, 2010	MC006594
Resistor, Thin Film, 715K, 0.1%, ±25ppm, 1/4W, 1210	MC006554	Resistor, Thin Film, 12R4, 0.1%, ±25ppm, 1/4W, 2010	MC006595
Resistor, Thin Film, 732K, 0.1%, ±25ppm, 1/4W, 1210	MC006555	Resistor, Thin Film, 12R7, 0.1%, ±25ppm, 1/4W, 2010	MC006596
Resistor, Thin Film, 750K, 0.1%, ±25ppm, 1/4W, 1210	MC006556	Resistor, Thin Film, 13R, 0.1%, ±25ppm, 1/4W, 2010	MC006597
Resistor, Thin Film, 768K, 0.1%, ±25ppm, 1/4W, 1210	MC006557	Resistor, Thin Film, 13R3, 0.1%, ±25ppm, 1/4W, 2010	MC006598
Resistor, Thin Film, 787K, 0.1%, ±25ppm, 1/4W, 1210	MC006558	Resistor, Thin Film, 13R7, 0.1%, ±25ppm, 1/4W, 2010	MC006599
Resistor, Thin Film, 806K, 0.1%, ±25ppm, 1/4W, 1210	MC006559	Resistor, Thin Film, 14R, 0.1%, ±25ppm, 1/4W, 2010	MC006600
Resistor, Thin Film, 825K, 0.1%, ±25ppm, 1/4W, 1210	MC006560	Resistor, Thin Film, 14R3, 0.1%, ±25ppm, 1/4W, 2010	MC006601
Resistor, Thin Film, 845K, 0.1%, ±25ppm, 1/4W, 1210	MC006561	Resistor, Thin Film, 14R7, 0.1%, ±25ppm, 1/4W, 2010	MC006602
Resistor, Thin Film, 866K, 0.1%, ±25ppm, 1/4W, 1210	MC006562	Resistor, Thin Film, 15R, 0.1%, ±25ppm, 1/4W, 2010	MC006603
Resistor, Thin Film, 887K, 0.1%, ±25ppm, 1/4W, 1210	MC006563	Resistor, Thin Film, 15R4, 0.1%, ±25ppm, 1/4W, 2010	MC006604
Resistor, Thin Film, 909K, 0.1%, ±25ppm, 1/4W, 1210	MC006564	Resistor, Thin Film, 15R8, 0.1%, ±25ppm, 1/4W, 2010	MC006605
Resistor, Thin Film, 931K, 0.1%, ±25ppm, 1/4W, 1210	MC006565	Resistor, Thin Film, 16R2, 0.1%, ±25ppm, 1/4W, 2010	MC006606
Resistor, Thin Film, 953K, 0.1%, ±25ppm, 1/4W, 1210	MC006566	Resistor, Thin Film, 16R5, 0.1%, ±25ppm, 1/4W, 2010	MC006607
Resistor, Thin Film, 976K, 0.1%, ±25ppm, 1/4W, 1210	MC006567	Resistor, Thin Film, 16R9, 0.1%, ±25ppm, 1/4W, 2010	MC006608
Resistor, Thin Film, 1M, 0.1%, ±25ppm, 1/4W, 1210	MC006568	Resistor, Thin Film, 17R4, 0.1%, ±25ppm, 1/4W, 2010	MC006609
Resistor, Thin Film, 1M1, 0.1%, ±25ppm, 1/4W, 1210	MC006569	Resistor, Thin Film, 17R8, 0.1%, ±25ppm, 1/4W, 2010	MC006610
Resistor, Thin Film, 1M2, 0.1%, ±25ppm, 1/4W, 1210	MC006570	Resistor, Thin Film, 18R2, 0.1%, ±25ppm, 1/4W, 2010	MC006611
Resistor, Thin Film, 1M3, 0.1%, ±25ppm, 1/4W, 1210	MC006571	Resistor, Thin Film, 18R7, 0.1%, ±25ppm, 1/4W, 2010	MC006612
Resistor, Thin Film, 1M5, 0.1%, ±25ppm, 1/4W, 1210	MC006572	Resistor, Thin Film, 19R1, 0.1%, ±25ppm, 1/4W, 2010	MC006613

www.element14.com
www.farnell.com
www.newark.com



Thin Film Precision Chip Resistor

Description	Part Number	Description	Part Number
Resistor, Thin Film, 19R6, 0.1%, ±25ppm, 1/4W, 2010	MC006614	Resistor, Thin Film, 56R2, 0.1%, ±25ppm, 1/4W, 2010	MC006655
Resistor, Thin Film, 20R, 0.1%, ±25ppm, 1/4W, 2010	MC006615	Resistor, Thin Film, 57R6, 0.1%, ±25ppm, 1/4W, 2010	MC006656
Resistor, Thin Film, 20R5, 0.1%, ±25ppm, 1/4W, 2010	MC006616	Resistor, Thin Film, 59R, 0.1%, ±25ppm, 1/4W, 2010	MC006657
Resistor, Thin Film, 21R, 0.1%, ±25ppm, 1/4W, 2010	MC006617	Resistor, Thin Film, 60R4, 0.1%, ±25ppm, 1/4W, 2010	MC006658
Resistor, Thin Film, 21R5, 0.1%, ±25ppm, 1/4W, 2010	MC006618	Resistor, Thin Film, 61R9, 0.1%, ±25ppm, 1/4W, 2010	MC006659
Resistor, Thin Film, 22R1, 0.1%, ±25ppm, 1/4W, 2010	MC006619	Resistor, Thin Film, 63R4, 0.1%, ±25ppm, 1/4W, 2010	MC006660
Resistor, Thin Film, 22R6, 0.1%, ±25ppm, 1/4W, 2010	MC006620	Resistor, Thin Film, 64R9, 0.1%, ±25ppm, 1/4W, 2010	MC006661
Resistor, Thin Film, 23R2, 0.1%, ±25ppm, 1/4W, 2010	MC006621	Resistor, Thin Film, 66R5, 0.1%, ±25ppm, 1/4W, 2010	MC006662
Resistor, Thin Film, 23R7, 0.1%, ±25ppm, 1/4W, 2010	MC006622	Resistor, Thin Film, 68R1, 0.1%, ±25ppm, 1/4W, 2010	MC006663
Resistor, Thin Film, 24R3, 0.1%, ±25ppm, 1/4W, 2010	MC006623	Resistor, Thin Film, 69R8, 0.1%, ±25ppm, 1/4W, 2010	MC006664
Resistor, Thin Film, 24R9, 0.1%, ±25ppm, 1/4W, 2010	MC006624	Resistor, Thin Film, 71R5, 0.1%, ±25ppm, 1/4W, 2010	MC006665
Resistor, Thin Film, 25R5, 0.1%, ±25ppm, 1/4W, 2010	MC006625	Resistor, Thin Film, 73R2, 0.1%, ±25ppm, 1/4W, 2010	MC006666
Resistor, Thin Film, 26R1, 0.1%, ±25ppm, 1/4W, 2010	MC006626	Resistor, Thin Film, 75R, 0.1%, ±25ppm, 1/4W, 2010	MC006667
Resistor, Thin Film, 26R7, 0.1%, ±25ppm, 1/4W, 2010	MC006627	Resistor, Thin Film, 76R8, 0.1%, ±25ppm, 1/4W, 2010	MC006668
Resistor, Thin Film, 27R4, 0.1%, ±25ppm, 1/4W, 2010	MC006628	Resistor, Thin Film, 78R7, 0.1%, ±25ppm, 1/4W, 2010	MC006669
Resistor, Thin Film, 28R, 0.1%, ±25ppm, 1/4W, 2010	MC006629	Resistor, Thin Film, 80R6, 0.1%, ±25ppm, 1/4W, 2010	MC006670
Resistor, Thin Film, 29R4, 0.1%, ±25ppm, 1/4W, 2010	MC006630	Resistor, Thin Film, 82R5, 0.1%, ±25ppm, 1/4W, 2010	MC006671
Resistor, Thin Film, 31R6, 0.1%, ±25ppm, 1/4W, 2010	MC006631	Resistor, Thin Film, 84R5, 0.1%, ±25ppm, 1/4W, 2010	MC006672
Resistor, Thin Film, 32R4, 0.1%, ±25ppm, 1/4W, 2010	MC006632	Resistor, Thin Film, 86R6, 0.1%, ±25ppm, 1/4W, 2010	MC006673
Resistor, Thin Film, 33R2, 0.1%, ±25ppm, 1/4W, 2010	MC006633	Resistor, Thin Film, 88R7, 0.1%, ±25ppm, 1/4W, 2010	MC006674
Resistor, Thin Film, 34R, 0.1%, ±25ppm, 1/4W, 2010	MC006634	Resistor, Thin Film, 90R9, 0.1%, ±25ppm, 1/4W, 2010	MC006675
Resistor, Thin Film, 34R8, 0.1%, ±25ppm, 1/4W, 2010	MC006635	Resistor, Thin Film, 93R1, 0.1%, ±25ppm, 1/4W, 2010	MC006676
Resistor, Thin Film, 35R7, 0.1%, ±25ppm, 1/4W, 2010	MC006636	Resistor, Thin Film, 95R3, 0.1%, ±25ppm, 1/4W, 2010	MC006677
Resistor, Thin Film, 36R5, 0.1%, ±25ppm, 1/4W, 2010	MC006637	Resistor, Thin Film, 97R6, 0.1%, ±25ppm, 1/4W, 2010	MC006678
Resistor, Thin Film, 37R4, 0.1%, ±25ppm, 1/4W, 2010	MC006638	Resistor, Thin Film, 100R, 0.1%, ±25ppm, 1/4W, 2010	MC006679
Resistor, Thin Film, 38R3, 0.1%, ±25ppm, 1/4W, 2010	MC006639	Resistor, Thin Film, 102R, 0.1%, ±25ppm, 1/4W, 2010	MC006680
Resistor, Thin Film, 39R2, 0.1%, ±25ppm, 1/4W, 2010	MC006640	Resistor, Thin Film, 105R, 0.1%, ±25ppm, 1/4W, 2010	MC006681
Resistor, Thin Film, 40R2, 0.1%, ±25ppm, 1/4W, 2010	MC006641	Resistor, Thin Film, 107R, 0.1%, ±25ppm, 1/4W, 2010	MC006682
Resistor, Thin Film, 41R2, 0.1%, ±25ppm, 1/4W, 2010	MC006642	Resistor, Thin Film, 110R, 0.1%, ±25ppm, 1/4W, 2010	MC006683
Resistor, Thin Film, 42R2, 0.1%, ±25ppm, 1/4W, 2010	MC006643	Resistor, Thin Film, 113R, 0.1%, ±25ppm, 1/4W, 2010	MC006684
Resistor, Thin Film, 43R2, 0.1%, ±25ppm, 1/4W, 2010	MC006644	Resistor, Thin Film, 115R, 0.1%, ±25ppm, 1/4W, 2010	MC006685
Resistor, Thin Film, 44R2, 0.1%, ±25ppm, 1/4W, 2010	MC006645	Resistor, Thin Film, 118R, 0.1%, ±25ppm, 1/4W, 2010	MC006686
Resistor, Thin Film, 45R3, 0.1%, ±25ppm, 1/4W, 2010	MC006646	Resistor, Thin Film, 121R, 0.1%, ±25ppm, 1/4W, 2010	MC006687
Resistor, Thin Film, 46R4, 0.1%, ±25ppm, 1/4W, 2010	MC006647	Resistor, Thin Film, 124R, 0.1%, ±25ppm, 1/4W, 2010	MC006688
Resistor, Thin Film, 47R5, 0.1%, ±25ppm, 1/4W, 2010	MC006648	Resistor, Thin Film, 127R, 0.1%, ±25ppm, 1/4W, 2010	MC006689
Resistor, Thin Film, 48R7, 0.1%, ±25ppm, 1/4W, 2010	MC006649	Resistor, Thin Film, 130R, 0.1%, ±25ppm, 1/4W, 2010	MC006690
Resistor, Thin Film, 49R9, 0.1%, ±25ppm, 1/4W, 2010	MC006650	Resistor, Thin Film, 133R, 0.1%, ±25ppm, 1/4W, 2010	MC006691
Resistor, Thin Film, 51R1, 0.1%, ±25ppm, 1/4W, 2010	MC006651	Resistor, Thin Film, 137R, 0.1%, ±25ppm, 1/4W, 2010	MC006692
Resistor, Thin Film, 52R3, 0.1%, ±25ppm, 1/4W, 2010	MC006652	Resistor, Thin Film, 140R, 0.1%, ±25ppm, 1/4W, 2010	MC006693
Resistor, Thin Film, 53R6, 0.1%, ±25ppm, 1/4W, 2010	MC006653	Resistor, Thin Film, 143R, 0.1%, ±25ppm, 1/4W, 2010	MC006694
Resistor, Thin Film, 54R9, 0.1%, ±25ppm, 1/4W, 2010	MC006654	Resistor, Thin Film, 147R, 0.1%, ±25ppm, 1/4W, 2010	MC006695

www.element14.com
www.farnell.com
www.newark.com



Thin Film Precision Chip Resistor

Description	Part Number	Description	Part Number
Resistor, Thin Film, 150R, 0.1%, ±25ppm, 1/4W, 2010	MC006696	Resistor, Thin Film, 432R, 0.1%, ±25ppm, 1/4W, 2010	MC006737
Resistor, Thin Film, 154R, 0.1%, ±25ppm, 1/4W, 2010	MC006697	Resistor, Thin Film, 442R, 0.1%, ±25ppm, 1/4W, 2010	MC006738
Resistor, Thin Film, 158R, 0.1%, ±25ppm, 1/4W, 2010	MC006698	Resistor, Thin Film, 453R, 0.1%, ±25ppm, 1/4W, 2010	MC006739
Resistor, Thin Film, 162R, 0.1%, ±25ppm, 1/4W, 2010	MC006699	Resistor, Thin Film, 464R, 0.1%, ±25ppm, 1/4W, 2010	MC006740
Resistor, Thin Film, 165R, 0.1%, ±25ppm, 1/4W, 2010	MC006700	Resistor, Thin Film, 475R, 0.1%, ±25ppm, 1/4W, 2010	MC006741
Resistor, Thin Film, 169R, 0.1%, ±25ppm, 1/4W, 2010	MC006701	Resistor, Thin Film, 487R, 0.1%, ±25ppm, 1/4W, 2010	MC006742
Resistor, Thin Film, 174R, 0.1%, ±25ppm, 1/4W, 2010	MC006702	Resistor, Thin Film, 499R, 0.1%, ±25ppm, 1/4W, 2010	MC006743
Resistor, Thin Film, 178R, 0.1%, ±25ppm, 1/4W, 2010	MC006703	Resistor, Thin Film, 511R, 0.1%, ±25ppm, 1/4W, 2010	MC006744
Resistor, Thin Film, 182R, 0.1%, ±25ppm, 1/4W, 2010	MC006704	Resistor, Thin Film, 523R, 0.1%, ±25ppm, 1/4W, 2010	MC006745
Resistor, Thin Film, 187R, 0.1%, ±25ppm, 1/4W, 2010	MC006705	Resistor, Thin Film, 536R, 0.1%, ±25ppm, 1/4W, 2010	MC006746
Resistor, Thin Film, 191R, 0.1%, ±25ppm, 1/4W, 2010	MC006706	Resistor, Thin Film, 549R, 0.1%, ±25ppm, 1/4W, 2010	MC006747
Resistor, Thin Film, 196R, 0.1%, ±25ppm, 1/4W, 2010	MC006707	Resistor, Thin Film, 562R, 0.1%, ±25ppm, 1/4W, 2010	MC006748
Resistor, Thin Film, 200R, 0.1%, ±25ppm, 1/4W, 2010	MC006708	Resistor, Thin Film, 576R, 0.1%, ±25ppm, 1/4W, 2010	MC006749
Resistor, Thin Film, 205R, 0.1%, ±25ppm, 1/4W, 2010	MC006709	Resistor, Thin Film, 590R, 0.1%, ±25ppm, 1/4W, 2010	MC006750
Resistor, Thin Film, 210R, 0.1%, ±25ppm, 1/4W, 2010	MC006710	Resistor, Thin Film, 604R, 0.1%, ±25ppm, 1/4W, 2010	MC006751
Resistor, Thin Film, 215R, 0.1%, ±25ppm, 1/4W, 2010	MC006711	Resistor, Thin Film, 619R, 0.1%, ±25ppm, 1/4W, 2010	MC006752
Resistor, Thin Film, 221R, 0.1%, ±25ppm, 1/4W, 2010	MC006712	Resistor, Thin Film, 634R, 0.1%, ±25ppm, 1/4W, 2010	MC006753
Resistor, Thin Film, 226R, 0.1%, ±25ppm, 1/4W, 2010	MC006713	Resistor, Thin Film, 649R, 0.1%, ±25ppm, 1/4W, 2010	MC006754
Resistor, Thin Film, 232R, 0.1%, ±25ppm, 1/4W, 2010	MC006714	Resistor, Thin Film, 665R, 0.1%, ±25ppm, 1/4W, 2010	MC006755
Resistor, Thin Film, 237R, 0.1%, ±25ppm, 1/4W, 2010	MC006715	Resistor, Thin Film, 681R, 0.1%, ±25ppm, 1/4W, 2010	MC006756
Resistor, Thin Film, 243R, 0.1%, ±25ppm, 1/4W, 2010	MC006716	Resistor, Thin Film, 698R, 0.1%, ±25ppm, 1/4W, 2010	MC006757
Resistor, Thin Film, 249R, 0.1%, ±25ppm, 1/4W, 2010	MC006717	Resistor, Thin Film, 715R, 0.1%, ±25ppm, 1/4W, 2010	MC006758
Resistor, Thin Film, 255R, 0.1%, ±25ppm, 1/4W, 2010	MC006718	Resistor, Thin Film, 732R, 0.1%, ±25ppm, 1/4W, 2010	MC006759
Resistor, Thin Film, 261R, 0.1%, ±25ppm, 1/4W, 2010	MC006719	Resistor, Thin Film, 750R, 0.1%, ±25ppm, 1/4W, 2010	MC006760
Resistor, Thin Film, 267R, 0.1%, ±25ppm, 1/4W, 2010	MC006720	Resistor, Thin Film, 768R, 0.1%, ±25ppm, 1/4W, 2010	MC006761
Resistor, Thin Film, 274R, 0.1%, ±25ppm, 1/4W, 2010	MC006721	Resistor, Thin Film, 787R, 0.1%, ±25ppm, 1/4W, 2010	MC006762
Resistor, Thin Film, 280R, 0.1%, ±25ppm, 1/4W, 2010	MC006722	Resistor, Thin Film, 806R, 0.1%, ±25ppm, 1/4W, 2010	MC006763
Resistor, Thin Film, 294R, 0.1%, ±25ppm, 1/4W, 2010	MC006723	Resistor, Thin Film, 825R, 0.1%, ±25ppm, 1/4W, 2010	MC006764
Resistor, Thin Film, 316R, 0.1%, ±25ppm, 1/4W, 2010	MC006724	Resistor, Thin Film, 845R, 0.1%, ±25ppm, 1/4W, 2010	MC006765
Resistor, Thin Film, 324R, 0.1%, ±25ppm, 1/4W, 2010	MC006725	Resistor, Thin Film, 866R, 0.1%, ±25ppm, 1/4W, 2010	MC006766
Resistor, Thin Film, 332R, 0.1%, ±25ppm, 1/4W, 2010	MC006726	Resistor, Thin Film, 887R, 0.1%, ±25ppm, 1/4W, 2010	MC006767
Resistor, Thin Film, 340R, 0.1%, ±25ppm, 1/4W, 2010	MC006727	Resistor, Thin Film, 909R, 0.1%, ±25ppm, 1/4W, 2010	MC006768
Resistor, Thin Film, 348R, 0.1%, ±25ppm, 1/4W, 2010	MC006728	Resistor, Thin Film, 931R, 0.1%, ±25ppm, 1/4W, 2010	MC006769
Resistor, Thin Film, 357R, 0.1%, ±25ppm, 1/4W, 2010	MC006729	Resistor, Thin Film, 953R, 0.1%, ±25ppm, 1/4W, 2010	MC006770
Resistor, Thin Film, 365R, 0.1%, ±25ppm, 1/4W, 2010	MC006730	Resistor, Thin Film, 976R, 0.1%, ±25ppm, 1/4W, 2010	MC006771
Resistor, Thin Film, 374R, 0.1%, ±25ppm, 1/4W, 2010	MC006731	Resistor, Thin Film, 1K, 0.1%, ±25ppm, 1/4W, 2010	MC006772
Resistor, Thin Film, 383R, 0.1%, ±25ppm, 1/4W, 2010	MC006732	Resistor, Thin Film, 1K02, 0.1%, ±25ppm, 1/4W, 2010	MC006773
Resistor, Thin Film, 392R, 0.1%, ±25ppm, 1/4W, 2010	MC006733	Resistor, Thin Film, 1K05, 0.1%, ±25ppm, 1/4W, 2010	MC006774
Resistor, Thin Film, 402R, 0.1%, ±25ppm, 1/4W, 2010	MC006734	Resistor, Thin Film, 1K07, 0.1%, ±25ppm, 1/4W, 2010	MC006775
Resistor, Thin Film, 412R, 0.1%, ±25ppm, 1/4W, 2010	MC006735	Resistor, Thin Film, 1K1, 0.1%, ±25ppm, 1/4W, 2010	MC006776
Resistor, Thin Film, 422R, 0.1%, ±25ppm, 1/4W, 2010	MC006736	Resistor, Thin Film, 1K13, 0.1%, ±25ppm, 1/4W, 2010	MC006777

Thin Film Precision Chip Resistor

Description	Part Number	Description	Part Number
Resistor, Thin Film, 1K15, 0.1%, ±25ppm, 1/4W, 2010	MC006778	Resistor, Thin Film, 3K32, 0.1%, ±25ppm, 1/4W, 2010	MC006819
Resistor, Thin Film, 1K18, 0.1%, ±25ppm, 1/4W, 2010	MC006779	Resistor, Thin Film, 3K4, 0.1%, ±25ppm, 1/4W, 2010	MC006820
Resistor, Thin Film, 1K21, 0.1%, ±25ppm, 1/4W, 2010	MC006780	Resistor, Thin Film, 3K48, 0.1%, ±25ppm, 1/4W, 2010	MC006821
Resistor, Thin Film, 1K24, 0.1%, ±25ppm, 1/4W, 2010	MC006781	Resistor, Thin Film, 3K57, 0.1%, ±25ppm, 1/4W, 2010	MC006822
Resistor, Thin Film, 1K27, 0.1%, ±25ppm, 1/4W, 2010	MC006782	Resistor, Thin Film, 3K65, 0.1%, ±25ppm, 1/4W, 2010	MC006823
Resistor, Thin Film, 1K3, 0.1%, ±25ppm, 1/4W, 2010	MC006783	Resistor, Thin Film, 3K74, 0.1%, ±25ppm, 1/4W, 2010	MC006824
Resistor, Thin Film, 1K33, 0.1%, ±25ppm, 1/4W, 2010	MC006784	Resistor, Thin Film, 3K83, 0.1%, ±25ppm, 1/4W, 2010	MC006825
Resistor, Thin Film, 1K37, 0.1%, ±25ppm, 1/4W, 2010	MC006785	Resistor, Thin Film, 3K92, 0.1%, ±25ppm, 1/4W, 2010	MC006826
Resistor, Thin Film, 1K4, 0.1%, ±25ppm, 1/4W, 2010	MC006786	Resistor, Thin Film, 4K02, 0.1%, ±25ppm, 1/4W, 2010	MC006827
Resistor, Thin Film, 1K43, 0.1%, ±25ppm, 1/4W, 2010	MC006787	Resistor, Thin Film, 4K12, 0.1%, ±25ppm, 1/4W, 2010	MC006828
Resistor, Thin Film, 1K47, 0.1%, ±25ppm, 1/4W, 2010	MC006788	Resistor, Thin Film, 4K22, 0.1%, ±25ppm, 1/4W, 2010	MC006829
Resistor, Thin Film, 1K5, 0.1%, ±25ppm, 1/4W, 2010	MC006789	Resistor, Thin Film, 4K32, 0.1%, ±25ppm, 1/4W, 2010	MC006830
Resistor, Thin Film, 1K54, 0.1%, ±25ppm, 1/4W, 2010	MC006790	Resistor, Thin Film, 4K42, 0.1%, ±25ppm, 1/4W, 2010	MC006831
Resistor, Thin Film, 1K58, 0.1%, ±25ppm, 1/4W, 2010	MC006791	Resistor, Thin Film, 4K53, 0.1%, ±25ppm, 1/4W, 2010	MC006832
Resistor, Thin Film, 1K62, 0.1%, ±25ppm, 1/4W, 2010	MC006792	Resistor, Thin Film, 4K64, 0.1%, ±25ppm, 1/4W, 2010	MC006833
Resistor, Thin Film, 1K65, 0.1%, ±25ppm, 1/4W, 2010	MC006793	Resistor, Thin Film, 4K75, 0.1%, ±25ppm, 1/4W, 2010	MC006834
Resistor, Thin Film, 1K69, 0.1%, ±25ppm, 1/4W, 2010	MC006794	Resistor, Thin Film, 4K87, 0.1%, ±25ppm, 1/4W, 2010	MC006835
Resistor, Thin Film, 1K74, 0.1%, ±25ppm, 1/4W, 2010	MC006795	Resistor, Thin Film, 4K99, 0.1%, ±25ppm, 1/4W, 2010	MC006836
Resistor, Thin Film, 1K78, 0.1%, ±25ppm, 1/4W, 2010	MC006796	Resistor, Thin Film, 5K11, 0.1%, ±25ppm, 1/4W, 2010	MC006837
Resistor, Thin Film, 1K82, 0.1%, ±25ppm, 1/4W, 2010	MC006797	Resistor, Thin Film, 5K23, 0.1%, ±25ppm, 1/4W, 2010	MC006838
Resistor, Thin Film, 1K87, 0.1%, ±25ppm, 1/4W, 2010	MC006798	Resistor, Thin Film, 5K36, 0.1%, ±25ppm, 1/4W, 2010	MC006839
Resistor, Thin Film, 1K91, 0.1%, ±25ppm, 1/4W, 2010	MC006799	Resistor, Thin Film, 5K49, 0.1%, ±25ppm, 1/4W, 2010	MC006840
Resistor, Thin Film, 1K96, 0.1%, ±25ppm, 1/4W, 2010	MC006800	Resistor, Thin Film, 5K62, 0.1%, ±25ppm, 1/4W, 2010	MC006841
Resistor, Thin Film, 2K, 0.1%, ±25ppm, 1/4W, 2010	MC006801	Resistor, Thin Film, 5K76, 0.1%, ±25ppm, 1/4W, 2010	MC006842
Resistor, Thin Film, 2K05, 0.1%, ±25ppm, 1/4W, 2010	MC006802	Resistor, Thin Film, 5K9, 0.1%, ±25ppm, 1/4W, 2010	MC006843
Resistor, Thin Film, 2K1, 0.1%, ±25ppm, 1/4W, 2010	MC006803	Resistor, Thin Film, 6K04, 0.1%, ±25ppm, 1/4W, 2010	MC006844
Resistor, Thin Film, 2K15, 0.1%, ±25ppm, 1/4W, 2010	MC006804	Resistor, Thin Film, 6K19, 0.1%, ±25ppm, 1/4W, 2010	MC006845
Resistor, Thin Film, 2K21, 0.1%, ±25ppm, 1/4W, 2010	MC006805	Resistor, Thin Film, 6K34, 0.1%, ±25ppm, 1/4W, 2010	MC006846
Resistor, Thin Film, 2K26, 0.1%, ±25ppm, 1/4W, 2010	MC006806	Resistor, Thin Film, 6K49, 0.1%, ±25ppm, 1/4W, 2010	MC006847
Resistor, Thin Film, 2K32, 0.1%, ±25ppm, 1/4W, 2010	MC006807	Resistor, Thin Film, 6K65, 0.1%, ±25ppm, 1/4W, 2010	MC006848
Resistor, Thin Film, 2K37, 0.1%, ±25ppm, 1/4W, 2010	MC006808	Resistor, Thin Film, 6K81, 0.1%, ±25ppm, 1/4W, 2010	MC006849
Resistor, Thin Film, 2K43, 0.1%, ±25ppm, 1/4W, 2010	MC006809	Resistor, Thin Film, 6K98, 0.1%, ±25ppm, 1/4W, 2010	MC006850
Resistor, Thin Film, 2K49, 0.1%, ±25ppm, 1/4W, 2010	MC006810	Resistor, Thin Film, 7K15, 0.1%, ±25ppm, 1/4W, 2010	MC006851
Resistor, Thin Film, 2K55, 0.1%, ±25ppm, 1/4W, 2010	MC006811	Resistor, Thin Film, 7K32, 0.1%, ±25ppm, 1/4W, 2010	MC006852
Resistor, Thin Film, 2K61, 0.1%, ±25ppm, 1/4W, 2010	MC006812	Resistor, Thin Film, 7K5, 0.1%, ±25ppm, 1/4W, 2010	MC006853
Resistor, Thin Film, 2K67, 0.1%, ±25ppm, 1/4W, 2010	MC006813	Resistor, Thin Film, 7K68, 0.1%, ±25ppm, 1/4W, 2010	MC006854
Resistor, Thin Film, 2K74, 0.1%, ±25ppm, 1/4W, 2010	MC006814	Resistor, Thin Film, 7K87, 0.1%, ±25ppm, 1/4W, 2010	MC006855
Resistor, Thin Film, 2K8, 0.1%, ±25ppm, 1/4W, 2010	MC006815	Resistor, Thin Film, 8K06, 0.1%, ±25ppm, 1/4W, 2010	MC006856
Resistor, Thin Film, 2K94, 0.1%, ±25ppm, 1/4W, 2010	MC006816	Resistor, Thin Film, 8K25, 0.1%, ±25ppm, 1/4W, 2010	MC006857
Resistor, Thin Film, 3K16, 0.1%, ±25ppm, 1/4W, 2010	MC006817	Resistor, Thin Film, 8K45, 0.1%, ±25ppm, 1/4W, 2010	MC006858
Resistor, Thin Film, 3K24, 0.1%, ±25ppm, 1/4W, 2010	MC006818	Resistor, Thin Film, 8K66, 0.1%, ±25ppm, 1/4W, 2010	MC006859

www.element14.com
www.farnell.com
www.newark.com



Thin Film Precision Chip Resistor

Description	Part Number	Description	Part Number
Resistor, Thin Film, 8K87, 0.1%, ±25ppm, 1/4W, 2010	MC006860	Resistor, Thin Film, 23K7, 0.1%, ±25ppm, 1/4W, 2010	MC006901
Resistor, Thin Film, 9K09, 0.1%, ±25ppm, 1/4W, 2010	MC006861	Resistor, Thin Film, 24K3, 0.1%, ±25ppm, 1/4W, 2010	MC006902
Resistor, Thin Film, 9K31, 0.1%, ±25ppm, 1/4W, 2010	MC006862	Resistor, Thin Film, 24K9, 0.1%, ±25ppm, 1/4W, 2010	MC006903
Resistor, Thin Film, 9K53, 0.1%, ±25ppm, 1/4W, 2010	MC006863	Resistor, Thin Film, 25K5, 0.1%, ±25ppm, 1/4W, 2010	MC006904
Resistor, Thin Film, 9K76, 0.1%, ±25ppm, 1/4W, 2010	MC006864	Resistor, Thin Film, 26K1, 0.1%, ±25ppm, 1/4W, 2010	MC006905
Resistor, Thin Film, 10K, 0.1%, ±25ppm, 1/4W, 2010	MC006865	Resistor, Thin Film, 26K7, 0.1%, ±25ppm, 1/4W, 2010	MC006906
Resistor, Thin Film, 10K2, 0.1%, ±25ppm, 1/4W, 2010	MC006866	Resistor, Thin Film, 27K4, 0.1%, ±25ppm, 1/4W, 2010	MC006907
Resistor, Thin Film, 10K5, 0.1%, ±25ppm, 1/4W, 2010	MC006867	Resistor, Thin Film, 28K, 0.1%, ±25ppm, 1/4W, 2010	MC006908
Resistor, Thin Film, 10K7, 0.1%, ±25ppm, 1/4W, 2010	MC006868	Resistor, Thin Film, 29K4, 0.1%, ±25ppm, 1/4W, 2010	MC006909
Resistor, Thin Film, 11K, 0.1%, ±25ppm, 1/4W, 2010	MC006869	Resistor, Thin Film, 31K6, 0.1%, ±25ppm, 1/4W, 2010	MC006910
Resistor, Thin Film, 11K3, 0.1%, ±25ppm, 1/4W, 2010	MC006870	Resistor, Thin Film, 32K4, 0.1%, ±25ppm, 1/4W, 2010	MC006911
Resistor, Thin Film, 11K5, 0.1%, ±25ppm, 1/4W, 2010	MC006871	Resistor, Thin Film, 33K2, 0.1%, ±25ppm, 1/4W, 2010	MC006912
Resistor, Thin Film, 11K8, 0.1%, ±25ppm, 1/4W, 2010	MC006872	Resistor, Thin Film, 34K, 0.1%, ±25ppm, 1/4W, 2010	MC006913
Resistor, Thin Film, 12K1, 0.1%, ±25ppm, 1/4W, 2010	MC006873	Resistor, Thin Film, 34K8, 0.1%, ±25ppm, 1/4W, 2010	MC006914
Resistor, Thin Film, 12K4, 0.1%, ±25ppm, 1/4W, 2010	MC006874	Resistor, Thin Film, 35K7, 0.1%, ±25ppm, 1/4W, 2010	MC006915
Resistor, Thin Film, 12K7, 0.1%, ±25ppm, 1/4W, 2010	MC006875	Resistor, Thin Film, 36K5, 0.1%, ±25ppm, 1/4W, 2010	MC006916
Resistor, Thin Film, 13K, 0.1%, ±25ppm, 1/4W, 2010	MC006876	Resistor, Thin Film, 37K4, 0.1%, ±25ppm, 1/4W, 2010	MC006917
Resistor, Thin Film, 13K3, 0.1%, ±25ppm, 1/4W, 2010	MC006877	Resistor, Thin Film, 38K3, 0.1%, ±25ppm, 1/4W, 2010	MC006918
Resistor, Thin Film, 13K7, 0.1%, ±25ppm, 1/4W, 2010	MC006878	Resistor, Thin Film, 39K2, 0.1%, ±25ppm, 1/4W, 2010	MC006919
Resistor, Thin Film, 14K, 0.1%, ±25ppm, 1/4W, 2010	MC006879	Resistor, Thin Film, 40K2, 0.1%, ±25ppm, 1/4W, 2010	MC006920
Resistor, Thin Film, 14K3, 0.1%, ±25ppm, 1/4W, 2010	MC006880	Resistor, Thin Film, 41K2, 0.1%, ±25ppm, 1/4W, 2010	MC006921
Resistor, Thin Film, 14K7, 0.1%, ±25ppm, 1/4W, 2010	MC006881	Resistor, Thin Film, 42K2, 0.1%, ±25ppm, 1/4W, 2010	MC006922
Resistor, Thin Film, 15K, 0.1%, ±25ppm, 1/4W, 2010	MC006882	Resistor, Thin Film, 43K2, 0.1%, ±25ppm, 1/4W, 2010	MC006923
Resistor, Thin Film, 15K4, 0.1%, ±25ppm, 1/4W, 2010	MC006883	Resistor, Thin Film, 44K2, 0.1%, ±25ppm, 1/4W, 2010	MC006924
Resistor, Thin Film, 15K8, 0.1%, ±25ppm, 1/4W, 2010	MC006884	Resistor, Thin Film, 45K3, 0.1%, ±25ppm, 1/4W, 2010	MC006925
Resistor, Thin Film, 16K2, 0.1%, ±25ppm, 1/4W, 2010	MC006885	Resistor, Thin Film, 46K4, 0.1%, ±25ppm, 1/4W, 2010	MC006926
Resistor, Thin Film, 16K5, 0.1%, ±25ppm, 1/4W, 2010	MC006886	Resistor, Thin Film, 47K5, 0.1%, ±25ppm, 1/4W, 2010	MC006927
Resistor, Thin Film, 16K9, 0.1%, ±25ppm, 1/4W, 2010	MC006887	Resistor, Thin Film, 48K7, 0.1%, ±25ppm, 1/4W, 2010	MC006928
Resistor, Thin Film, 17K4, 0.1%, ±25ppm, 1/4W, 2010	MC006888	Resistor, Thin Film, 49K9, 0.1%, ±25ppm, 1/4W, 2010	MC006929
Resistor, Thin Film, 17K8, 0.1%, ±25ppm, 1/4W, 2010	MC006889	Resistor, Thin Film, 51K1, 0.1%, ±25ppm, 1/4W, 2010	MC006930
Resistor, Thin Film, 18K2, 0.1%, ±25ppm, 1/4W, 2010	MC006890	Resistor, Thin Film, 52K3, 0.1%, ±25ppm, 1/4W, 2010	MC006931
Resistor, Thin Film, 18K7, 0.1%, ±25ppm, 1/4W, 2010	MC006891	Resistor, Thin Film, 53K6, 0.1%, ±25ppm, 1/4W, 2010	MC006932
Resistor, Thin Film, 19K1, 0.1%, ±25ppm, 1/4W, 2010	MC006892	Resistor, Thin Film, 54K9, 0.1%, ±25ppm, 1/4W, 2010	MC006933
Resistor, Thin Film, 19K6, 0.1%, ±25ppm, 1/4W, 2010	MC006893	Resistor, Thin Film, 56K2, 0.1%, ±25ppm, 1/4W, 2010	MC006934
Resistor, Thin Film, 20K, 0.1%, ±25ppm, 1/4W, 2010	MC006894	Resistor, Thin Film, 57K6, 0.1%, ±25ppm, 1/4W, 2010	MC006935
Resistor, Thin Film, 20K5, 0.1%, ±25ppm, 1/4W, 2010	MC006895	Resistor, Thin Film, 59K, 0.1%, ±25ppm, 1/4W, 2010	MC006936
Resistor, Thin Film, 21K, 0.1%, ±25ppm, 1/4W, 2010	MC006896	Resistor, Thin Film, 60K4, 0.1%, ±25ppm, 1/4W, 2010	MC006937
Resistor, Thin Film, 21K5, 0.1%, ±25ppm, 1/4W, 2010	MC006897	Resistor, Thin Film, 61K9, 0.1%, ±25ppm, 1/4W, 2010	MC006938
Resistor, Thin Film, 22K1, 0.1%, ±25ppm, 1/4W, 2010	MC006898	Resistor, Thin Film, 63K4, 0.1%, ±25ppm, 1/4W, 2010	MC006939
Resistor, Thin Film, 22K6, 0.1%, ±25ppm, 1/4W, 2010	MC006899	Resistor, Thin Film, 64K9, 0.1%, ±25ppm, 1/4W, 2010	MC006940
Resistor, Thin Film, 23K2, 0.1%, ±25ppm, 1/4W, 2010	MC006900	Resistor, Thin Film, 66K5, 0.1%, ±25ppm, 1/4W, 2010	MC006941

www.element14.com
www.farnell.com
www.newark.com



Thin Film Precision Chip Resistor

Description	Part Number	Description	Part Number
Resistor, Thin Film, 68K1, 0.1%, ±25ppm, 1/4W, 2010	MC006942	Resistor, Thin Film, 182K, 0.1%, ±25ppm, 1/4W, 2010	MC006983
Resistor, Thin Film, 69K8, 0.1%, ±25ppm, 1/4W, 2010	MC006943	Resistor, Thin Film, 187K, 0.1%, ±25ppm, 1/4W, 2010	MC006984
Resistor, Thin Film, 71K5, 0.1%, ±25ppm, 1/4W, 2010	MC006944	Resistor, Thin Film, 191K, 0.1%, ±25ppm, 1/4W, 2010	MC006985
Resistor, Thin Film, 73K2, 0.1%, ±25ppm, 1/4W, 2010	MC006945	Resistor, Thin Film, 196K, 0.1%, ±25ppm, 1/4W, 2010	MC006986
Resistor, Thin Film, 75K, 0.1%, ±25ppm, 1/4W, 2010	MC006946	Resistor, Thin Film, 200K, 0.1%, ±25ppm, 1/4W, 2010	MC006987
Resistor, Thin Film, 76K8, 0.1%, ±25ppm, 1/4W, 2010	MC006947	Resistor, Thin Film, 205K, 0.1%, ±25ppm, 1/4W, 2010	MC006988
Resistor, Thin Film, 78K7, 0.1%, ±25ppm, 1/4W, 2010	MC006948	Resistor, Thin Film, 210K, 0.1%, ±25ppm, 1/4W, 2010	MC006989
Resistor, Thin Film, 80K6, 0.1%, ±25ppm, 1/4W, 2010	MC006949	Resistor, Thin Film, 215K, 0.1%, ±25ppm, 1/4W, 2010	MC006990
Resistor, Thin Film, 82K5, 0.1%, ±25ppm, 1/4W, 2010	MC006950	Resistor, Thin Film, 221K, 0.1%, ±25ppm, 1/4W, 2010	MC006991
Resistor, Thin Film, 84K5, 0.1%, ±25ppm, 1/4W, 2010	MC006951	Resistor, Thin Film, 226K, 0.1%, ±25ppm, 1/4W, 2010	MC006992
Resistor, Thin Film, 86K6, 0.1%, ±25ppm, 1/4W, 2010	MC006952	Resistor, Thin Film, 232K, 0.1%, ±25ppm, 1/4W, 2010	MC006993
Resistor, Thin Film, 88K7, 0.1%, ±25ppm, 1/4W, 2010	MC006953	Resistor, Thin Film, 237K, 0.1%, ±25ppm, 1/4W, 2010	MC006994
Resistor, Thin Film, 90K9, 0.1%, ±25ppm, 1/4W, 2010	MC006954	Resistor, Thin Film, 243K, 0.1%, ±25ppm, 1/4W, 2010	MC006995
Resistor, Thin Film, 93K1, 0.1%, ±25ppm, 1/4W, 2010	MC006955	Resistor, Thin Film, 249K, 0.1%, ±25ppm, 1/4W, 2010	MC006996
Resistor, Thin Film, 95K3, 0.1%, ±25ppm, 1/4W, 2010	MC006956	Resistor, Thin Film, 255K, 0.1%, ±25ppm, 1/4W, 2010	MC006997
Resistor, Thin Film, 97K6, 0.1%, ±25ppm, 1/4W, 2010	MC006957	Resistor, Thin Film, 261K, 0.1%, ±25ppm, 1/4W, 2010	MC006998
Resistor, Thin Film, 100K, 0.1%, ±25ppm, 1/4W, 2010	MC006958	Resistor, Thin Film, 267K, 0.1%, ±25ppm, 1/4W, 2010	MC006999
Resistor, Thin Film, 102K, 0.1%, ±25ppm, 1/4W, 2010	MC006959	Resistor, Thin Film, 274K, 0.1%, ±25ppm, 1/4W, 2010	MC007000
Resistor, Thin Film, 105K, 0.1%, ±25ppm, 1/4W, 2010	MC006960	Resistor, Thin Film, 280K, 0.1%, ±25ppm, 1/4W, 2010	MC007001
Resistor, Thin Film, 107K, 0.1%, ±25ppm, 1/4W, 2010	MC006961	Resistor, Thin Film, 294K, 0.1%, ±25ppm, 1/4W, 2010	MC007002
Resistor, Thin Film, 110K, 0.1%, ±25ppm, 1/4W, 2010	MC006962	Resistor, Thin Film, 316K, 0.1%, ±25ppm, 1/4W, 2010	MC007003
Resistor, Thin Film, 113K, 0.1%, ±25ppm, 1/4W, 2010	MC006963	Resistor, Thin Film, 324K, 0.1%, ±25ppm, 1/4W, 2010	MC007004
Resistor, Thin Film, 115K, 0.1%, ±25ppm, 1/4W, 2010	MC006964	Resistor, Thin Film, 332K, 0.1%, ±25ppm, 1/4W, 2010	MC007005
Resistor, Thin Film, 118K, 0.1%, ±25ppm, 1/4W, 2010	MC006965	Resistor, Thin Film, 340K, 0.1%, ±25ppm, 1/4W, 2010	MC007006
Resistor, Thin Film, 121K, 0.1%, ±25ppm, 1/4W, 2010	MC006966	Resistor, Thin Film, 348K, 0.1%, ±25ppm, 1/4W, 2010	MC007007
Resistor, Thin Film, 124K, 0.1%, ±25ppm, 1/4W, 2010	MC006967	Resistor, Thin Film, 357K, 0.1%, ±25ppm, 1/4W, 2010	MC007008
Resistor, Thin Film, 127K, 0.1%, ±25ppm, 1/4W, 2010	MC006968	Resistor, Thin Film, 365K, 0.1%, ±25ppm, 1/4W, 2010	MC007009
Resistor, Thin Film, 130K, 0.1%, ±25ppm, 1/4W, 2010	MC006969	Resistor, Thin Film, 374K, 0.1%, ±25ppm, 1/4W, 2010	MC007010
Resistor, Thin Film, 133K, 0.1%, ±25ppm, 1/4W, 2010	MC006970	Resistor, Thin Film, 383K, 0.1%, ±25ppm, 1/4W, 2010	MC007011
Resistor, Thin Film, 137K, 0.1%, ±25ppm, 1/4W, 2010	MC006971	Resistor, Thin Film, 392K, 0.1%, ±25ppm, 1/4W, 2010	MC007012
Resistor, Thin Film, 140K, 0.1%, ±25ppm, 1/4W, 2010	MC006972	Resistor, Thin Film, 402K, 0.1%, ±25ppm, 1/4W, 2010	MC007013
Resistor, Thin Film, 143K, 0.1%, ±25ppm, 1/4W, 2010	MC006973	Resistor, Thin Film, 412K, 0.1%, ±25ppm, 1/4W, 2010	MC007014
Resistor, Thin Film, 147K, 0.1%, ±25ppm, 1/4W, 2010	MC006974	Resistor, Thin Film, 422K, 0.1%, ±25ppm, 1/4W, 2010	MC007015
Resistor, Thin Film, 150K, 0.1%, ±25ppm, 1/4W, 2010	MC006975	Resistor, Thin Film, 432K, 0.1%, ±25ppm, 1/4W, 2010	MC007016
Resistor, Thin Film, 154K, 0.1%, ±25ppm, 1/4W, 2010	MC006976	Resistor, Thin Film, 442K, 0.1%, ±25ppm, 1/4W, 2010	MC007017
Resistor, Thin Film, 158K, 0.1%, ±25ppm, 1/4W, 2010	MC006977	Resistor, Thin Film, 453K, 0.1%, ±25ppm, 1/4W, 2010	MC007018
Resistor, Thin Film, 162K, 0.1%, ±25ppm, 1/4W, 2010	MC006978	Resistor, Thin Film, 464K, 0.1%, ±25ppm, 1/4W, 2010	MC007019
Resistor, Thin Film, 165K, 0.1%, ±25ppm, 1/4W, 2010	MC006979	Resistor, Thin Film, 475K, 0.1%, ±25ppm, 1/4W, 2010	MC007020
Resistor, Thin Film, 169K, 0.1%, ±25ppm, 1/4W, 2010	MC006980	Resistor, Thin Film, 487K, 0.1%, ±25ppm, 1/4W, 2010	MC007021
Resistor, Thin Film, 174K, 0.1%, ±25ppm, 1/4W, 2010	MC006981	Resistor, Thin Film, 499K, 0.1%, ±25ppm, 1/4W, 2010	MC007022
Resistor, Thin Film, 178K, 0.1%, ±25ppm, 1/4W, 2010	MC006982	Resistor, Thin Film, 511K, 0.1%, ±25ppm, 1/4W, 2010	MC007023

www.element14.com
www.farnell.com
www.newark.com



Thin Film Precision Chip Resistor

Description	Part Number	Description	Part Number
Resistor, Thin Film, 523K, 0.1%, ±25ppm, 1/4W, 2010	MC007024	Resistor, Thin Film, 6R2, 0.1%, ±25ppm, 1/2W, 2512	MC007065
Resistor, Thin Film, 536K, 0.1%, ±25ppm, 1/4W, 2010	MC007025	Resistor, Thin Film, 6R8, 0.1%, ±25ppm, 1/2W, 2512	MC007066
Resistor, Thin Film, 549K, 0.1%, ±25ppm, 1/4W, 2010	MC007026	Resistor, Thin Film, 7R5, 0.1%, ±25ppm, 1/2W, 2512	MC007067
Resistor, Thin Film, 562K, 0.1%, ±25ppm, 1/4W, 2010	MC007027	Resistor, Thin Film, 8R2, 0.1%, ±25ppm, 1/2W, 2512	MC007068
Resistor, Thin Film, 576K, 0.1%, ±25ppm, 1/4W, 2010	MC007028	Resistor, Thin Film, 9R1, 0.1%, ±25ppm, 1/2W, 2512	MC007069
Resistor, Thin Film, 590K, 0.1%, ±25ppm, 1/4W, 2010	MC007029	Resistor, Thin Film, 10R, 0.1%, ±25ppm, 1/2W, 2512	MC007070
Resistor, Thin Film, 604K, 0.1%, ±25ppm, 1/4W, 2010	MC007030	Resistor, Thin Film, 10R2, 0.1%, ±25ppm, 1/2W, 2512	MC007071
Resistor, Thin Film, 619K, 0.1%, ±25ppm, 1/4W, 2010	MC007031	Resistor, Thin Film, 10R5, 0.1%, ±25ppm, 1/2W, 2512	MC007072
Resistor, Thin Film, 634K, 0.1%, ±25ppm, 1/4W, 2010	MC007032	Resistor, Thin Film, 10R7, 0.1%, ±25ppm, 1/2W, 2512	MC007073
Resistor, Thin Film, 649K, 0.1%, ±25ppm, 1/4W, 2010	MC007033	Resistor, Thin Film, 11R, 0.1%, ±25ppm, 1/2W, 2512	MC007074
Resistor, Thin Film, 665K, 0.1%, ±25ppm, 1/4W, 2010	MC007034	Resistor, Thin Film, 11R3, 0.1%, ±25ppm, 1/2W, 2512	MC007075
Resistor, Thin Film, 681K, 0.1%, ±25ppm, 1/4W, 2010	MC007035	Resistor, Thin Film, 11R5, 0.1%, ±25ppm, 1/2W, 2512	MC007076
Resistor, Thin Film, 698K, 0.1%, ±25ppm, 1/4W, 2010	MC007036	Resistor, Thin Film, 11R8, 0.1%, ±25ppm, 1/2W, 2512	MC007077
Resistor, Thin Film, 715K, 0.1%, ±25ppm, 1/4W, 2010	MC007037	Resistor, Thin Film, 12R1, 0.1%, ±25ppm, 1/2W, 2512	MC007078
Resistor, Thin Film, 732K, 0.1%, ±25ppm, 1/4W, 2010	MC007038	Resistor, Thin Film, 12R4, 0.1%, ±25ppm, 1/2W, 2512	MC007079
Resistor, Thin Film, 750K, 0.1%, ±25ppm, 1/4W, 2010	MC007039	Resistor, Thin Film, 12R7, 0.1%, ±25ppm, 1/2W, 2512	MC007080
Resistor, Thin Film, 768K, 0.1%, ±25ppm, 1/4W, 2010	MC007040	Resistor, Thin Film, 13R, 0.1%, ±25ppm, 1/2W, 2512	MC007081
Resistor, Thin Film, 787K, 0.1%, ±25ppm, 1/4W, 2010	MC007041	Resistor, Thin Film, 13R3, 0.1%, ±25ppm, 1/2W, 2512	MC007082
Resistor, Thin Film, 806K, 0.1%, ±25ppm, 1/4W, 2010	MC007042	Resistor, Thin Film, 13R7, 0.1%, ±25ppm, 1/2W, 2512	MC007083
Resistor, Thin Film, 825K, 0.1%, ±25ppm, 1/4W, 2010	MC007043	Resistor, Thin Film, 14R, 0.1%, ±25ppm, 1/2W, 2512	MC007084
Resistor, Thin Film, 845K, 0.1%, ±25ppm, 1/4W, 2010	MC007044	Resistor, Thin Film, 14R3, 0.1%, ±25ppm, 1/2W, 2512	MC007085
Resistor, Thin Film, 866K, 0.1%, ±25ppm, 1/4W, 2010	MC007045	Resistor, Thin Film, 14R7, 0.1%, ±25ppm, 1/2W, 2512	MC007086
Resistor, Thin Film, 887K, 0.1%, ±25ppm, 1/4W, 2010	MC007046	Resistor, Thin Film, 15R, 0.1%, ±25ppm, 1/2W, 2512	MC007087
Resistor, Thin Film, 909K, 0.1%, ±25ppm, 1/4W, 2010	MC007047	Resistor, Thin Film, 15R4, 0.1%, ±25ppm, 1/2W, 2512	MC007088
Resistor, Thin Film, 931K, 0.1%, ±25ppm, 1/4W, 2010	MC007048	Resistor, Thin Film, 15R8, 0.1%, ±25ppm, 1/2W, 2512	MC007089
Resistor, Thin Film, 953K, 0.1%, ±25ppm, 1/4W, 2010	MC007049	Resistor, Thin Film, 16R2, 0.1%, ±25ppm, 1/2W, 2512	MC007090
Resistor, Thin Film, 976K, 0.1%, ±25ppm, 1/4W, 2010	MC007050	Resistor, Thin Film, 16R5, 0.1%, ±25ppm, 1/2W, 2512	MC007091
Resistor, Thin Film, 1M, 0.1%, ±25ppm, 1/4W, 2010	MC007051	Resistor, Thin Film, 16R9, 0.1%, ±25ppm, 1/2W, 2512	MC007092
Resistor, Thin Film, 1M1, 0.1%, ±25ppm, 1/4W, 2010	MC007052	Resistor, Thin Film, 17R4, 0.1%, ±25ppm, 1/2W, 2512	MC007093
Resistor, Thin Film, 1M2, 0.1%, ±25ppm, 1/4W, 2010	MC007053	Resistor, Thin Film, 17R8, 0.1%, ±25ppm, 1/2W, 2512	MC007094
Resistor, Thin Film, 1M3, 0.1%, ±25ppm, 1/4W, 2010	MC007054	Resistor, Thin Film, 18R2, 0.1%, ±25ppm, 1/2W, 2512	MC007095
Resistor, Thin Film, 1M5, 0.1%, ±25ppm, 1/4W, 2010	MC007055	Resistor, Thin Film, 18R7, 0.1%, ±25ppm, 1/2W, 2512	MC007096
Resistor, Thin Film, 1M6, 0.1%, ±25ppm, 1/4W, 2010	MC007056	Resistor, Thin Film, 19R1, 0.1%, ±25ppm, 1/2W, 2512	MC007097
Resistor, Thin Film, 1M8, 0.1%, ±25ppm, 1/4W, 2010	MC007057	Resistor, Thin Film, 19R6, 0.1%, ±25ppm, 1/2W, 2512	MC007098
Resistor, Thin Film, 2M, 0.1%, ±25ppm, 1/4W, 2010	MC007058	Resistor, Thin Film, 20R, 0.1%, ±25ppm, 1/2W, 2512	MC007099
Resistor, Thin Film, 2M4, 0.1%, ±25ppm, 1/4W, 2010	MC007059	Resistor, Thin Film, 20R5, 0.1%, ±25ppm, 1/2W, 2512	MC007100
Resistor, Thin Film, 2M7, 0.1%, ±25ppm, 1/4W, 2010	MC007060	Resistor, Thin Film, 21R, 0.1%, ±25ppm, 1/2W, 2512	MC007101
Resistor, Thin Film, 3M, 0.1%, ±25ppm, 1/4W, 2010	MC007061	Resistor, Thin Film, 21R5, 0.1%, ±25ppm, 1/2W, 2512	MC007102
Resistor, Thin Film, 4R7, 0.1%, ±25ppm, 1/2W, 2512	MC007062	Resistor, Thin Film, 22R1, 0.1%, ±25ppm, 1/2W, 2512	MC007103
Resistor, Thin Film, 5R1, 0.1%, ±25ppm, 1/2W, 2512	MC007063	Resistor, Thin Film, 22R6, 0.1%, ±25ppm, 1/2W, 2512	MC007104
Resistor, Thin Film, 5R6, 0.1%, ±25ppm, 1/2W, 2512	MC007064	Resistor, Thin Film, 23R2, 0.1%, ±25ppm, 1/2W, 2512	MC007105

www.element14.com
www.farnell.com
www.newark.com



Thin Film Precision Chip Resistor

Description	Part Number	Description	Part Number
Resistor, Thin Film, 23R7, 0.1%, ±25ppm, 1/2W, 2512	MC007106	Resistor, Thin Film, 68R1, 0.1%, ±25ppm, 1/2W, 2512	MC007147
Resistor, Thin Film, 24R3, 0.1%, ±25ppm, 1/2W, 2512	MC007107	Resistor, Thin Film, 69R8, 0.1%, ±25ppm, 1/2W, 2512	MC007148
Resistor, Thin Film, 24R9, 0.1%, ±25ppm, 1/2W, 2512	MC007108	Resistor, Thin Film, 71R5, 0.1%, ±25ppm, 1/2W, 2512	MC007149
Resistor, Thin Film, 25R5, 0.1%, ±25ppm, 1/2W, 2512	MC007109	Resistor, Thin Film, 73R2, 0.1%, ±25ppm, 1/2W, 2512	MC007150
Resistor, Thin Film, 26R1, 0.1%, ±25ppm, 1/2W, 2512	MC007110	Resistor, Thin Film, 75R, 0.1%, ±25ppm, 1/2W, 2512	MC007151
Resistor, Thin Film, 26R7, 0.1%, ±25ppm, 1/2W, 2512	MC007111	Resistor, Thin Film, 76R8, 0.1%, ±25ppm, 1/2W, 2512	MC007152
Resistor, Thin Film, 27R4, 0.1%, ±25ppm, 1/2W, 2512	MC007112	Resistor, Thin Film, 78R7, 0.1%, ±25ppm, 1/2W, 2512	MC007153
Resistor, Thin Film, 28R, 0.1%, ±25ppm, 1/2W, 2512	MC007113	Resistor, Thin Film, 80R6, 0.1%, ±25ppm, 1/2W, 2512	MC007154
Resistor, Thin Film, 29R4, 0.1%, ±25ppm, 1/2W, 2512	MC007114	Resistor, Thin Film, 82R5, 0.1%, ±25ppm, 1/2W, 2512	MC007155
Resistor, Thin Film, 31R6, 0.1%, ±25ppm, 1/2W, 2512	MC007115	Resistor, Thin Film, 84R5, 0.1%, ±25ppm, 1/2W, 2512	MC007156
Resistor, Thin Film, 32R4, 0.1%, ±25ppm, 1/2W, 2512	MC007116	Resistor, Thin Film, 86R6, 0.1%, ±25ppm, 1/2W, 2512	MC007157
Resistor, Thin Film, 33R2, 0.1%, ±25ppm, 1/2W, 2512	MC007117	Resistor, Thin Film, 88R7, 0.1%, ±25ppm, 1/2W, 2512	MC007158
Resistor, Thin Film, 34R, 0.1%, ±25ppm, 1/2W, 2512	MC007118	Resistor, Thin Film, 90R9, 0.1%, ±25ppm, 1/2W, 2512	MC007159
Resistor, Thin Film, 34R8, 0.1%, ±25ppm, 1/2W, 2512	MC007119	Resistor, Thin Film, 93R1, 0.1%, ±25ppm, 1/2W, 2512	MC007160
Resistor, Thin Film, 35R7, 0.1%, ±25ppm, 1/2W, 2512	MC007120	Resistor, Thin Film, 95R3, 0.1%, ±25ppm, 1/2W, 2512	MC007161
Resistor, Thin Film, 36R5, 0.1%, ±25ppm, 1/2W, 2512	MC007121	Resistor, Thin Film, 97R6, 0.1%, ±25ppm, 1/2W, 2512	MC007162
Resistor, Thin Film, 37R4, 0.1%, ±25ppm, 1/2W, 2512	MC007122	Resistor, Thin Film, 100R, 0.1%, ±25ppm, 1/2W, 2512	MC007163
Resistor, Thin Film, 38R3, 0.1%, ±25ppm, 1/2W, 2512	MC007123	Resistor, Thin Film, 102R, 0.1%, ±25ppm, 1/2W, 2512	MC007164
Resistor, Thin Film, 39R2, 0.1%, ±25ppm, 1/2W, 2512	MC007124	Resistor, Thin Film, 105R, 0.1%, ±25ppm, 1/2W, 2512	MC007165
Resistor, Thin Film, 40R2, 0.1%, ±25ppm, 1/2W, 2512	MC007125	Resistor, Thin Film, 107R, 0.1%, ±25ppm, 1/2W, 2512	MC007166
Resistor, Thin Film, 41R2, 0.1%, ±25ppm, 1/2W, 2512	MC007126	Resistor, Thin Film, 110R, 0.1%, ±25ppm, 1/2W, 2512	MC007167
Resistor, Thin Film, 42R2, 0.1%, ±25ppm, 1/2W, 2512	MC007127	Resistor, Thin Film, 113R, 0.1%, ±25ppm, 1/2W, 2512	MC007168
Resistor, Thin Film, 43R2, 0.1%, ±25ppm, 1/2W, 2512	MC007128	Resistor, Thin Film, 115R, 0.1%, ±25ppm, 1/2W, 2512	MC007169
Resistor, Thin Film, 44R2, 0.1%, ±25ppm, 1/2W, 2512	MC007129	Resistor, Thin Film, 118R, 0.1%, ±25ppm, 1/2W, 2512	MC007170
Resistor, Thin Film, 45R3, 0.1%, ±25ppm, 1/2W, 2512	MC007130	Resistor, Thin Film, 121R, 0.1%, ±25ppm, 1/2W, 2512	MC007171
Resistor, Thin Film, 46R4, 0.1%, ±25ppm, 1/2W, 2512	MC007131	Resistor, Thin Film, 124R, 0.1%, ±25ppm, 1/2W, 2512	MC007172
Resistor, Thin Film, 47R5, 0.1%, ±25ppm, 1/2W, 2512	MC007132	Resistor, Thin Film, 127R, 0.1%, ±25ppm, 1/2W, 2512	MC007173
Resistor, Thin Film, 48R7, 0.1%, ±25ppm, 1/2W, 2512	MC007133	Resistor, Thin Film, 130R, 0.1%, ±25ppm, 1/2W, 2512	MC007174
Resistor, Thin Film, 49R9, 0.1%, ±25ppm, 1/2W, 2512	MC007134	Resistor, Thin Film, 133R, 0.1%, ±25ppm, 1/2W, 2512	MC007175
Resistor, Thin Film, 51R1, 0.1%, ±25ppm, 1/2W, 2512	MC007135	Resistor, Thin Film, 137R, 0.1%, ±25ppm, 1/2W, 2512	MC007176
Resistor, Thin Film, 52R3, 0.1%, ±25ppm, 1/2W, 2512	MC007136	Resistor, Thin Film, 140R, 0.1%, ±25ppm, 1/2W, 2512	MC007177
Resistor, Thin Film, 53R6, 0.1%, ±25ppm, 1/2W, 2512	MC007137	Resistor, Thin Film, 143R, 0.1%, ±25ppm, 1/2W, 2512	MC007178
Resistor, Thin Film, 54R9, 0.1%, ±25ppm, 1/2W, 2512	MC007138	Resistor, Thin Film, 147R, 0.1%, ±25ppm, 1/2W, 2512	MC007179
Resistor, Thin Film, 56R2, 0.1%, ±25ppm, 1/2W, 2512	MC007139	Resistor, Thin Film, 150R, 0.1%, ±25ppm, 1/2W, 2512	MC007180
Resistor, Thin Film, 57R6, 0.1%, ±25ppm, 1/2W, 2512	MC007140	Resistor, Thin Film, 154R, 0.1%, ±25ppm, 1/2W, 2512	MC007181
Resistor, Thin Film, 59R, 0.1%, ±25ppm, 1/2W, 2512	MC007141	Resistor, Thin Film, 158R, 0.1%, ±25ppm, 1/2W, 2512	MC007182
Resistor, Thin Film, 60R4, 0.1%, ±25ppm, 1/2W, 2512	MC007142	Resistor, Thin Film, 162R, 0.1%, ±25ppm, 1/2W, 2512	MC007183
Resistor, Thin Film, 61R9, 0.1%, ±25ppm, 1/2W, 2512	MC007143	Resistor, Thin Film, 165R, 0.1%, ±25ppm, 1/2W, 2512	MC007184
Resistor, Thin Film, 63R4, 0.1%, ±25ppm, 1/2W, 2512	MC007144	Resistor, Thin Film, 169R, 0.1%, ±25ppm, 1/2W, 2512	MC007185
Resistor, Thin Film, 64R9, 0.1%, ±25ppm, 1/2W, 2512	MC007145	Resistor, Thin Film, 174R, 0.1%, ±25ppm, 1/2W, 2512	MC007186
Resistor, Thin Film, 66R5, 0.1%, ±25ppm, 1/2W, 2512	MC007146	Resistor, Thin Film, 178R, 0.1%, ±25ppm, 1/2W, 2512	MC007187

www.element14.com
www.farnell.com
www.newark.com



Thin Film Precision Chip Resistor

Description	Part Number	Description	Part Number
Resistor, Thin Film, 182R, 0.1%, ±25ppm, 1/2W, 2512	MC007188	Resistor, Thin Film, 523R, 0.1%, ±25ppm, 1/2W, 2512	MC007229
Resistor, Thin Film, 187R, 0.1%, ±25ppm, 1/2W, 2512	MC007189	Resistor, Thin Film, 536R, 0.1%, ±25ppm, 1/2W, 2512	MC007230
Resistor, Thin Film, 191R, 0.1%, ±25ppm, 1/2W, 2512	MC007190	Resistor, Thin Film, 549R, 0.1%, ±25ppm, 1/2W, 2512	MC007231
Resistor, Thin Film, 196R, 0.1%, ±25ppm, 1/2W, 2512	MC007191	Resistor, Thin Film, 562R, 0.1%, ±25ppm, 1/2W, 2512	MC007232
Resistor, Thin Film, 200R, 0.1%, ±25ppm, 1/2W, 2512	MC007192	Resistor, Thin Film, 576R, 0.1%, ±25ppm, 1/2W, 2512	MC007233
Resistor, Thin Film, 205R, 0.1%, ±25ppm, 1/2W, 2512	MC007193	Resistor, Thin Film, 590R, 0.1%, ±25ppm, 1/2W, 2512	MC007234
Resistor, Thin Film, 210R, 0.1%, ±25ppm, 1/2W, 2512	MC007194	Resistor, Thin Film, 604R, 0.1%, ±25ppm, 1/2W, 2512	MC007235
Resistor, Thin Film, 215R, 0.1%, ±25ppm, 1/2W, 2512	MC007195	Resistor, Thin Film, 619R, 0.1%, ±25ppm, 1/2W, 2512	MC007236
Resistor, Thin Film, 221R, 0.1%, ±25ppm, 1/2W, 2512	MC007196	Resistor, Thin Film, 634R, 0.1%, ±25ppm, 1/2W, 2512	MC007237
Resistor, Thin Film, 226R, 0.1%, ±25ppm, 1/2W, 2512	MC007197	Resistor, Thin Film, 649R, 0.1%, ±25ppm, 1/2W, 2512	MC007238
Resistor, Thin Film, 232R, 0.1%, ±25ppm, 1/2W, 2512	MC007198	Resistor, Thin Film, 665R, 0.1%, ±25ppm, 1/2W, 2512	MC007239
Resistor, Thin Film, 237R, 0.1%, ±25ppm, 1/2W, 2512	MC007199	Resistor, Thin Film, 681R, 0.1%, ±25ppm, 1/2W, 2512	MC007240
Resistor, Thin Film, 243R, 0.1%, ±25ppm, 1/2W, 2512	MC007200	Resistor, Thin Film, 698R, 0.1%, ±25ppm, 1/2W, 2512	MC007241
Resistor, Thin Film, 249R, 0.1%, ±25ppm, 1/2W, 2512	MC007201	Resistor, Thin Film, 715R, 0.1%, ±25ppm, 1/2W, 2512	MC007242
Resistor, Thin Film, 255R, 0.1%, ±25ppm, 1/2W, 2512	MC007202	Resistor, Thin Film, 732R, 0.1%, ±25ppm, 1/2W, 2512	MC007243
Resistor, Thin Film, 261R, 0.1%, ±25ppm, 1/2W, 2512	MC007203	Resistor, Thin Film, 750R, 0.1%, ±25ppm, 1/2W, 2512	MC007244
Resistor, Thin Film, 267R, 0.1%, ±25ppm, 1/2W, 2512	MC007204	Resistor, Thin Film, 768R, 0.1%, ±25ppm, 1/2W, 2512	MC007245
Resistor, Thin Film, 274R, 0.1%, ±25ppm, 1/2W, 2512	MC007205	Resistor, Thin Film, 787R, 0.1%, ±25ppm, 1/2W, 2512	MC007246
Resistor, Thin Film, 280R, 0.1%, ±25ppm, 1/2W, 2512	MC007206	Resistor, Thin Film, 806R, 0.1%, ±25ppm, 1/2W, 2512	MC007247
Resistor, Thin Film, 294R, 0.1%, ±25ppm, 1/2W, 2512	MC007207	Resistor, Thin Film, 825R, 0.1%, ±25ppm, 1/2W, 2512	MC007248
Resistor, Thin Film, 316R, 0.1%, ±25ppm, 1/2W, 2512	MC007208	Resistor, Thin Film, 845R, 0.1%, ±25ppm, 1/2W, 2512	MC007249
Resistor, Thin Film, 324R, 0.1%, ±25ppm, 1/2W, 2512	MC007209	Resistor, Thin Film, 866R, 0.1%, ±25ppm, 1/2W, 2512	MC007250
Resistor, Thin Film, 332R, 0.1%, ±25ppm, 1/2W, 2512	MC007210	Resistor, Thin Film, 887R, 0.1%, ±25ppm, 1/2W, 2512	MC007251
Resistor, Thin Film, 340R, 0.1%, ±25ppm, 1/2W, 2512	MC007211	Resistor, Thin Film, 909R, 0.1%, ±25ppm, 1/2W, 2512	MC007252
Resistor, Thin Film, 348R, 0.1%, ±25ppm, 1/2W, 2512	MC007212	Resistor, Thin Film, 931R, 0.1%, ±25ppm, 1/2W, 2512	MC007253
Resistor, Thin Film, 357R, 0.1%, ±25ppm, 1/2W, 2512	MC007213	Resistor, Thin Film, 953R, 0.1%, ±25ppm, 1/2W, 2512	MC007254
Resistor, Thin Film, 365R, 0.1%, ±25ppm, 1/2W, 2512	MC007214	Resistor, Thin Film, 976R, 0.1%, ±25ppm, 1/2W, 2512	MC007255
Resistor, Thin Film, 374R, 0.1%, ±25ppm, 1/2W, 2512	MC007215	Resistor, Thin Film, 1K, 0.1%, ±25ppm, 1/2W, 2512	MC007256
Resistor, Thin Film, 383R, 0.1%, ±25ppm, 1/2W, 2512	MC007216	Resistor, Thin Film, 1K02, 0.1%, ±25ppm, 1/2W, 2512	MC007257
Resistor, Thin Film, 392R, 0.1%, ±25ppm, 1/2W, 2512	MC007217	Resistor, Thin Film, 1K05, 0.1%, ±25ppm, 1/2W, 2512	MC007258
Resistor, Thin Film, 402R, 0.1%, ±25ppm, 1/2W, 2512	MC007218	Resistor, Thin Film, 1K07, 0.1%, ±25ppm, 1/2W, 2512	MC007259
Resistor, Thin Film, 412R, 0.1%, ±25ppm, 1/2W, 2512	MC007219	Resistor, Thin Film, 1K1, 0.1%, ±25ppm, 1/2W, 2512	MC007260
Resistor, Thin Film, 422R, 0.1%, ±25ppm, 1/2W, 2512	MC007220	Resistor, Thin Film, 1K13, 0.1%, ±25ppm, 1/2W, 2512	MC007261
Resistor, Thin Film, 432R, 0.1%, ±25ppm, 1/2W, 2512	MC007221	Resistor, Thin Film, 1K15, 0.1%, ±25ppm, 1/2W, 2512	MC007262
Resistor, Thin Film, 442R, 0.1%, ±25ppm, 1/2W, 2512	MC007222	Resistor, Thin Film, 1K18, 0.1%, ±25ppm, 1/2W, 2512	MC007263
Resistor, Thin Film, 453R, 0.1%, ±25ppm, 1/2W, 2512	MC007223	Resistor, Thin Film, 1K21, 0.1%, ±25ppm, 1/2W, 2512	MC007264
Resistor, Thin Film, 464R, 0.1%, ±25ppm, 1/2W, 2512	MC007224	Resistor, Thin Film, 1K24, 0.1%, ±25ppm, 1/2W, 2512	MC007265
Resistor, Thin Film, 475R, 0.1%, ±25ppm, 1/2W, 2512	MC007225	Resistor, Thin Film, 1K27, 0.1%, ±25ppm, 1/2W, 2512	MC007266
Resistor, Thin Film, 487R, 0.1%, ±25ppm, 1/2W, 2512	MC007226	Resistor, Thin Film, 1K3, 0.1%, ±25ppm, 1/2W, 2512	MC007267
Resistor, Thin Film, 499R, 0.1%, ±25ppm, 1/2W, 2512	MC007227	Resistor, Thin Film, 1K33, 0.1%, ±25ppm, 1/2W, 2512	MC007268
Resistor, Thin Film, 511R, 0.1%, ±25ppm, 1/2W, 2512	MC007228	Resistor, Thin Film, 1K37, 0.1%, ±25ppm, 1/2W, 2512	MC007269

www.element14.com
www.farnell.com
www.newark.com



Thin Film Precision Chip Resistor

Description	Part Number	Description	Part Number
Resistor, Thin Film, 1K4, 0.1%, ±25ppm, 1/2W, 2512	MC007270	Resistor, Thin Film, 4K02, 0.1%, ±25ppm, 1/2W, 2512	MC007311
Resistor, Thin Film, 1K43, 0.1%, ±25ppm, 1/2W, 2512	MC007271	Resistor, Thin Film, 4K12, 0.1%, ±25ppm, 1/2W, 2512	MC007312
Resistor, Thin Film, 1K47, 0.1%, ±25ppm, 1/2W, 2512	MC007272	Resistor, Thin Film, 4K22, 0.1%, ±25ppm, 1/2W, 2512	MC007313
Resistor, Thin Film, 1K5, 0.1%, ±25ppm, 1/2W, 2512	MC007273	Resistor, Thin Film, 4K32, 0.1%, ±25ppm, 1/2W, 2512	MC007314
Resistor, Thin Film, 1K54, 0.1%, ±25ppm, 1/2W, 2512	MC007274	Resistor, Thin Film, 4K42, 0.1%, ±25ppm, 1/2W, 2512	MC007315
Resistor, Thin Film, 1K58, 0.1%, ±25ppm, 1/2W, 2512	MC007275	Resistor, Thin Film, 4K53, 0.1%, ±25ppm, 1/2W, 2512	MC007316
Resistor, Thin Film, 1K62, 0.1%, ±25ppm, 1/2W, 2512	MC007276	Resistor, Thin Film, 4K64, 0.1%, ±25ppm, 1/2W, 2512	MC007317
Resistor, Thin Film, 1K65, 0.1%, ±25ppm, 1/2W, 2512	MC007277	Resistor, Thin Film, 4K75, 0.1%, ±25ppm, 1/2W, 2512	MC007318
Resistor, Thin Film, 1K69, 0.1%, ±25ppm, 1/2W, 2512	MC007278	Resistor, Thin Film, 4K87, 0.1%, ±25ppm, 1/2W, 2512	MC007319
Resistor, Thin Film, 1K74, 0.1%, ±25ppm, 1/2W, 2512	MC007279	Resistor, Thin Film, 4K99, 0.1%, ±25ppm, 1/2W, 2512	MC007320
Resistor, Thin Film, 1K78, 0.1%, ±25ppm, 1/2W, 2512	MC007280	Resistor, Thin Film, 5K11, 0.1%, ±25ppm, 1/2W, 2512	MC007321
Resistor, Thin Film, 1K82, 0.1%, ±25ppm, 1/2W, 2512	MC007281	Resistor, Thin Film, 5K23, 0.1%, ±25ppm, 1/2W, 2512	MC007322
Resistor, Thin Film, 1K87, 0.1%, ±25ppm, 1/2W, 2512	MC007282	Resistor, Thin Film, 5K36, 0.1%, ±25ppm, 1/2W, 2512	MC007323
Resistor, Thin Film, 1K91, 0.1%, ±25ppm, 1/2W, 2512	MC007283	Resistor, Thin Film, 5K49, 0.1%, ±25ppm, 1/2W, 2512	MC007324
Resistor, Thin Film, 1K96, 0.1%, ±25ppm, 1/2W, 2512	MC007284	Resistor, Thin Film, 5K62, 0.1%, ±25ppm, 1/2W, 2512	MC007325
Resistor, Thin Film, 2K, 0.1%, ±25ppm, 1/2W, 2512	MC007285	Resistor, Thin Film, 5K76, 0.1%, ±25ppm, 1/2W, 2512	MC007326
Resistor, Thin Film, 2K05, 0.1%, ±25ppm, 1/2W, 2512	MC007286	Resistor, Thin Film, 5K9, 0.1%, ±25ppm, 1/2W, 2512	MC007327
Resistor, Thin Film, 2K1, 0.1%, ±25ppm, 1/2W, 2512	MC007287	Resistor, Thin Film, 6K04, 0.1%, ±25ppm, 1/2W, 2512	MC007328
Resistor, Thin Film, 2K15, 0.1%, ±25ppm, 1/2W, 2512	MC007288	Resistor, Thin Film, 6K19, 0.1%, ±25ppm, 1/2W, 2512	MC007329
Resistor, Thin Film, 2K21, 0.1%, ±25ppm, 1/2W, 2512	MC007289	Resistor, Thin Film, 6K34, 0.1%, ±25ppm, 1/2W, 2512	MC007330
Resistor, Thin Film, 2K26, 0.1%, ±25ppm, 1/2W, 2512	MC007290	Resistor, Thin Film, 6K49, 0.1%, ±25ppm, 1/2W, 2512	MC007331
Resistor, Thin Film, 2K32, 0.1%, ±25ppm, 1/2W, 2512	MC007291	Resistor, Thin Film, 6K65, 0.1%, ±25ppm, 1/2W, 2512	MC007332
Resistor, Thin Film, 2K37, 0.1%, ±25ppm, 1/2W, 2512	MC007292	Resistor, Thin Film, 6K81, 0.1%, ±25ppm, 1/2W, 2512	MC007333
Resistor, Thin Film, 2K43, 0.1%, ±25ppm, 1/2W, 2512	MC007293	Resistor, Thin Film, 6K98, 0.1%, ±25ppm, 1/2W, 2512	MC007334
Resistor, Thin Film, 2K49, 0.1%, ±25ppm, 1/2W, 2512	MC007294	Resistor, Thin Film, 7K15, 0.1%, ±25ppm, 1/2W, 2512	MC007335
Resistor, Thin Film, 2K55, 0.1%, ±25ppm, 1/2W, 2512	MC007295	Resistor, Thin Film, 7K32, 0.1%, ±25ppm, 1/2W, 2512	MC007336
Resistor, Thin Film, 2K61, 0.1%, ±25ppm, 1/2W, 2512	MC007296	Resistor, Thin Film, 7K5, 0.1%, ±25ppm, 1/2W, 2512	MC007337
Resistor, Thin Film, 2K67, 0.1%, ±25ppm, 1/2W, 2512	MC007297	Resistor, Thin Film, 7K68, 0.1%, ±25ppm, 1/2W, 2512	MC007338
Resistor, Thin Film, 2K74, 0.1%, ±25ppm, 1/2W, 2512	MC007298	Resistor, Thin Film, 7K87, 0.1%, ±25ppm, 1/2W, 2512	MC007339
Resistor, Thin Film, 2K8, 0.1%, ±25ppm, 1/2W, 2512	MC007299	Resistor, Thin Film, 8K06, 0.1%, ±25ppm, 1/2W, 2512	MC007340
Resistor, Thin Film, 2K94, 0.1%, ±25ppm, 1/2W, 2512	MC007300	Resistor, Thin Film, 8K25, 0.1%, ±25ppm, 1/2W, 2512	MC007341
Resistor, Thin Film, 3K16, 0.1%, ±25ppm, 1/2W, 2512	MC007301	Resistor, Thin Film, 8K45, 0.1%, ±25ppm, 1/2W, 2512	MC007342
Resistor, Thin Film, 3K24, 0.1%, ±25ppm, 1/2W, 2512	MC007302	Resistor, Thin Film, 8K66, 0.1%, ±25ppm, 1/2W, 2512	MC007343
Resistor, Thin Film, 3K32, 0.1%, ±25ppm, 1/2W, 2512	MC007303	Resistor, Thin Film, 8K87, 0.1%, ±25ppm, 1/2W, 2512	MC007344
Resistor, Thin Film, 3K4, 0.1%, ±25ppm, 1/2W, 2512	MC007304	Resistor, Thin Film, 9K09, 0.1%, ±25ppm, 1/2W, 2512	MC007345
Resistor, Thin Film, 3K48, 0.1%, ±25ppm, 1/2W, 2512	MC007305	Resistor, Thin Film, 9K31, 0.1%, ±25ppm, 1/2W, 2512	MC007346
Resistor, Thin Film, 3K57, 0.1%, ±25ppm, 1/2W, 2512	MC007306	Resistor, Thin Film, 9K53, 0.1%, ±25ppm, 1/2W, 2512	MC007347
Resistor, Thin Film, 3K65, 0.1%, ±25ppm, 1/2W, 2512	MC007307	Resistor, Thin Film, 9K76, 0.1%, ±25ppm, 1/2W, 2512	MC007348
Resistor, Thin Film, 3K74, 0.1%, ±25ppm, 1/2W, 2512	MC007308	Resistor, Thin Film, 10K, 0.1%, ±25ppm, 1/2W, 2512	MC007349
Resistor, Thin Film, 3K83, 0.1%, ±25ppm, 1/2W, 2512	MC007309	Resistor, Thin Film, 10K2, 0.1%, ±25ppm, 1/2W, 2512	MC007350
Resistor, Thin Film, 3K92, 0.1%, ±25ppm, 1/2W, 2512	MC007310	Resistor, Thin Film, 10K5, 0.1%, ±25ppm, 1/2W, 2512	MC007351

www.element14.com
www.farnell.com
www.newark.com



Thin Film Precision Chip Resistor

Description	Part Number	Description	Part Number
Resistor, Thin Film, 10K7, 0.1%, ±25ppm, 1/2W, 2512	MC007352	Resistor, Thin Film, 29K4, 0.1%, ±25ppm, 1/2W, 2512	MC007393
Resistor, Thin Film, 11K, 0.1%, ±25ppm, 1/2W, 2512	MC007353	Resistor, Thin Film, 31K6, 0.1%, ±25ppm, 1/2W, 2512	MC007394
Resistor, Thin Film, 11K3, 0.1%, ±25ppm, 1/2W, 2512	MC007354	Resistor, Thin Film, 32K4, 0.1%, ±25ppm, 1/2W, 2512	MC007395
Resistor, Thin Film, 11K5, 0.1%, ±25ppm, 1/2W, 2512	MC007355	Resistor, Thin Film, 33K2, 0.1%, ±25ppm, 1/2W, 2512	MC007396
Resistor, Thin Film, 11K8, 0.1%, ±25ppm, 1/2W, 2512	MC007356	Resistor, Thin Film, 34K, 0.1%, ±25ppm, 1/2W, 2512	MC007397
Resistor, Thin Film, 12K1, 0.1%, ±25ppm, 1/2W, 2512	MC007357	Resistor, Thin Film, 34K8, 0.1%, ±25ppm, 1/2W, 2512	MC007398
Resistor, Thin Film, 12K4, 0.1%, ±25ppm, 1/2W, 2512	MC007358	Resistor, Thin Film, 35K7, 0.1%, ±25ppm, 1/2W, 2512	MC007399
Resistor, Thin Film, 12K7, 0.1%, ±25ppm, 1/2W, 2512	MC007359	Resistor, Thin Film, 36K5, 0.1%, ±25ppm, 1/2W, 2512	MC007400
Resistor, Thin Film, 13K, 0.1%, ±25ppm, 1/2W, 2512	MC007360	Resistor, Thin Film, 37K4, 0.1%, ±25ppm, 1/2W, 2512	MC007401
Resistor, Thin Film, 13K3, 0.1%, ±25ppm, 1/2W, 2512	MC007361	Resistor, Thin Film, 38K3, 0.1%, ±25ppm, 1/2W, 2512	MC007402
Resistor, Thin Film, 13K7, 0.1%, ±25ppm, 1/2W, 2512	MC007362	Resistor, Thin Film, 39K2, 0.1%, ±25ppm, 1/2W, 2512	MC007403
Resistor, Thin Film, 14K, 0.1%, ±25ppm, 1/2W, 2512	MC007363	Resistor, Thin Film, 40K2, 0.1%, ±25ppm, 1/2W, 2512	MC007404
Resistor, Thin Film, 14K3, 0.1%, ±25ppm, 1/2W, 2512	MC007364	Resistor, Thin Film, 41K2, 0.1%, ±25ppm, 1/2W, 2512	MC007405
Resistor, Thin Film, 14K7, 0.1%, ±25ppm, 1/2W, 2512	MC007365	Resistor, Thin Film, 42K2, 0.1%, ±25ppm, 1/2W, 2512	MC007406
Resistor, Thin Film, 15K, 0.1%, ±25ppm, 1/2W, 2512	MC007366	Resistor, Thin Film, 43K2, 0.1%, ±25ppm, 1/2W, 2512	MC007407
Resistor, Thin Film, 15K4, 0.1%, ±25ppm, 1/2W, 2512	MC007367	Resistor, Thin Film, 44K2, 0.1%, ±25ppm, 1/2W, 2512	MC007408
Resistor, Thin Film, 15K8, 0.1%, ±25ppm, 1/2W, 2512	MC007368	Resistor, Thin Film, 45K3, 0.1%, ±25ppm, 1/2W, 2512	MC007409
Resistor, Thin Film, 16K2, 0.1%, ±25ppm, 1/2W, 2512	MC007369	Resistor, Thin Film, 46K4, 0.1%, ±25ppm, 1/2W, 2512	MC007410
Resistor, Thin Film, 16K5, 0.1%, ±25ppm, 1/2W, 2512	MC007370	Resistor, Thin Film, 47K5, 0.1%, ±25ppm, 1/2W, 2512	MC007411
Resistor, Thin Film, 16K9, 0.1%, ±25ppm, 1/2W, 2512	MC007371	Resistor, Thin Film, 48K7, 0.1%, ±25ppm, 1/2W, 2512	MC007412
Resistor, Thin Film, 17K4, 0.1%, ±25ppm, 1/2W, 2512	MC007372	Resistor, Thin Film, 49K9, 0.1%, ±25ppm, 1/2W, 2512	MC007413
Resistor, Thin Film, 17K8, 0.1%, ±25ppm, 1/2W, 2512	MC007373	Resistor, Thin Film, 51K1, 0.1%, ±25ppm, 1/2W, 2512	MC007414
Resistor, Thin Film, 18K2, 0.1%, ±25ppm, 1/2W, 2512	MC007374	Resistor, Thin Film, 52K3, 0.1%, ±25ppm, 1/2W, 2512	MC007415
Resistor, Thin Film, 18K7, 0.1%, ±25ppm, 1/2W, 2512	MC007375	Resistor, Thin Film, 53K6, 0.1%, ±25ppm, 1/2W, 2512	MC007416
Resistor, Thin Film, 19K1, 0.1%, ±25ppm, 1/2W, 2512	MC007376	Resistor, Thin Film, 54K9, 0.1%, ±25ppm, 1/2W, 2512	MC007417
Resistor, Thin Film, 19K6, 0.1%, ±25ppm, 1/2W, 2512	MC007377	Resistor, Thin Film, 56K2, 0.1%, ±25ppm, 1/2W, 2512	MC007418
Resistor, Thin Film, 20K, 0.1%, ±25ppm, 1/2W, 2512	MC007378	Resistor, Thin Film, 57K6, 0.1%, ±25ppm, 1/2W, 2512	MC007419
Resistor, Thin Film, 20K5, 0.1%, ±25ppm, 1/2W, 2512	MC007379	Resistor, Thin Film, 59K, 0.1%, ±25ppm, 1/2W, 2512	MC007420
Resistor, Thin Film, 21K, 0.1%, ±25ppm, 1/2W, 2512	MC007380	Resistor, Thin Film, 60K4, 0.1%, ±25ppm, 1/2W, 2512	MC007421
Resistor, Thin Film, 21K5, 0.1%, ±25ppm, 1/2W, 2512	MC007381	Resistor, Thin Film, 61K9, 0.1%, ±25ppm, 1/2W, 2512	MC007422
Resistor, Thin Film, 22K1, 0.1%, ±25ppm, 1/2W, 2512	MC007382	Resistor, Thin Film, 63K4, 0.1%, ±25ppm, 1/2W, 2512	MC007423
Resistor, Thin Film, 22K6, 0.1%, ±25ppm, 1/2W, 2512	MC007383	Resistor, Thin Film, 64K9, 0.1%, ±25ppm, 1/2W, 2512	MC007424
Resistor, Thin Film, 23K2, 0.1%, ±25ppm, 1/2W, 2512	MC007384	Resistor, Thin Film, 66K5, 0.1%, ±25ppm, 1/2W, 2512	MC007425
Resistor, Thin Film, 23K7, 0.1%, ±25ppm, 1/2W, 2512	MC007385	Resistor, Thin Film, 68K1, 0.1%, ±25ppm, 1/2W, 2512	MC007426
Resistor, Thin Film, 24K3, 0.1%, ±25ppm, 1/2W, 2512	MC007386	Resistor, Thin Film, 69K8, 0.1%, ±25ppm, 1/2W, 2512	MC007427
Resistor, Thin Film, 24K9, 0.1%, ±25ppm, 1/2W, 2512	MC007387	Resistor, Thin Film, 71K5, 0.1%, ±25ppm, 1/2W, 2512	MC007428
Resistor, Thin Film, 25K5, 0.1%, ±25ppm, 1/2W, 2512	MC007388	Resistor, Thin Film, 73K2, 0.1%, ±25ppm, 1/2W, 2512	MC007429
Resistor, Thin Film, 26K1, 0.1%, ±25ppm, 1/2W, 2512	MC007389	Resistor, Thin Film, 75K, 0.1%, ±25ppm, 1/2W, 2512	MC007430
Resistor, Thin Film, 26K7, 0.1%, ±25ppm, 1/2W, 2512	MC007390	Resistor, Thin Film, 76K8, 0.1%, ±25ppm, 1/2W, 2512	MC007431
Resistor, Thin Film, 27K4, 0.1%, ±25ppm, 1/2W, 2512	MC007391	Resistor, Thin Film, 78K7, 0.1%, ±25ppm, 1/2W, 2512	MC007432
Resistor, Thin Film, 28K, 0.1%, ±25ppm, 1/2W, 2512	MC007392	Resistor, Thin Film, 80K6, 0.1%, ±25ppm, 1/2W, 2512	MC007433

www.element14.com
www.farnell.com
www.newark.com



Thin Film Precision Chip Resistor

Description	Part Number	Description	Part Number
Resistor, Thin Film, 82K5, 0.1%, ±25ppm, 1/2W, 2512	MC007434	Resistor, Thin Film, 221K, 0.1%, ±25ppm, 1/2W, 2512	MC007475
Resistor, Thin Film, 84K5, 0.1%, ±25ppm, 1/2W, 2512	MC007435	Resistor, Thin Film, 226K, 0.1%, ±25ppm, 1/2W, 2512	MC007476
Resistor, Thin Film, 86K6, 0.1%, ±25ppm, 1/2W, 2512	MC007436	Resistor, Thin Film, 232K, 0.1%, ±25ppm, 1/2W, 2512	MC007477
Resistor, Thin Film, 88K7, 0.1%, ±25ppm, 1/2W, 2512	MC007437	Resistor, Thin Film, 237K, 0.1%, ±25ppm, 1/2W, 2512	MC007478
Resistor, Thin Film, 90K9, 0.1%, ±25ppm, 1/2W, 2512	MC007438	Resistor, Thin Film, 243K, 0.1%, ±25ppm, 1/2W, 2512	MC007479
Resistor, Thin Film, 93K1, 0.1%, ±25ppm, 1/2W, 2512	MC007439	Resistor, Thin Film, 249K, 0.1%, ±25ppm, 1/2W, 2512	MC007480
Resistor, Thin Film, 95K3, 0.1%, ±25ppm, 1/2W, 2512	MC007440	Resistor, Thin Film, 255K, 0.1%, ±25ppm, 1/2W, 2512	MC007481
Resistor, Thin Film, 97K6, 0.1%, ±25ppm, 1/2W, 2512	MC007441	Resistor, Thin Film, 261K, 0.1%, ±25ppm, 1/2W, 2512	MC007482
Resistor, Thin Film, 100K, 0.1%, ±25ppm, 1/2W, 2512	MC007442	Resistor, Thin Film, 267K, 0.1%, ±25ppm, 1/2W, 2512	MC007483
Resistor, Thin Film, 102K, 0.1%, ±25ppm, 1/2W, 2512	MC007443	Resistor, Thin Film, 274K, 0.1%, ±25ppm, 1/2W, 2512	MC007484
Resistor, Thin Film, 105K, 0.1%, ±25ppm, 1/2W, 2512	MC007444	Resistor, Thin Film, 280K, 0.1%, ±25ppm, 1/2W, 2512	MC007485
Resistor, Thin Film, 107K, 0.1%, ±25ppm, 1/2W, 2512	MC007445	Resistor, Thin Film, 294K, 0.1%, ±25ppm, 1/2W, 2512	MC007486
Resistor, Thin Film, 110K, 0.1%, ±25ppm, 1/2W, 2512	MC007446	Resistor, Thin Film, 316K, 0.1%, ±25ppm, 1/2W, 2512	MC007487
Resistor, Thin Film, 113K, 0.1%, ±25ppm, 1/2W, 2512	MC007447	Resistor, Thin Film, 324K, 0.1%, ±25ppm, 1/2W, 2512	MC007488
Resistor, Thin Film, 115K, 0.1%, ±25ppm, 1/2W, 2512	MC007448	Resistor, Thin Film, 332K, 0.1%, ±25ppm, 1/2W, 2512	MC007489
Resistor, Thin Film, 118K, 0.1%, ±25ppm, 1/2W, 2512	MC007449	Resistor, Thin Film, 340K, 0.1%, ±25ppm, 1/2W, 2512	MC007490
Resistor, Thin Film, 121K, 0.1%, ±25ppm, 1/2W, 2512	MC007450	Resistor, Thin Film, 348K, 0.1%, ±25ppm, 1/2W, 2512	MC007491
Resistor, Thin Film, 124K, 0.1%, ±25ppm, 1/2W, 2512	MC007451	Resistor, Thin Film, 357K, 0.1%, ±25ppm, 1/2W, 2512	MC007492
Resistor, Thin Film, 127K, 0.1%, ±25ppm, 1/2W, 2512	MC007452	Resistor, Thin Film, 365K, 0.1%, ±25ppm, 1/2W, 2512	MC007493
Resistor, Thin Film, 130K, 0.1%, ±25ppm, 1/2W, 2512	MC007453	Resistor, Thin Film, 374K, 0.1%, ±25ppm, 1/2W, 2512	MC007494
Resistor, Thin Film, 133K, 0.1%, ±25ppm, 1/2W, 2512	MC007454	Resistor, Thin Film, 383K, 0.1%, ±25ppm, 1/2W, 2512	MC007495
Resistor, Thin Film, 137K, 0.1%, ±25ppm, 1/2W, 2512	MC007455	Resistor, Thin Film, 392K, 0.1%, ±25ppm, 1/2W, 2512	MC007496
Resistor, Thin Film, 140K, 0.1%, ±25ppm, 1/2W, 2512	MC007456	Resistor, Thin Film, 402K, 0.1%, ±25ppm, 1/2W, 2512	MC007497
Resistor, Thin Film, 143K, 0.1%, ±25ppm, 1/2W, 2512	MC007457	Resistor, Thin Film, 412K, 0.1%, ±25ppm, 1/2W, 2512	MC007498
Resistor, Thin Film, 147K, 0.1%, ±25ppm, 1/2W, 2512	MC007458	Resistor, Thin Film, 422K, 0.1%, ±25ppm, 1/2W, 2512	MC007499
Resistor, Thin Film, 150K, 0.1%, ±25ppm, 1/2W, 2512	MC007459	Resistor, Thin Film, 432K, 0.1%, ±25ppm, 1/2W, 2512	MC007500
Resistor, Thin Film, 154K, 0.1%, ±25ppm, 1/2W, 2512	MC007460	Resistor, Thin Film, 442K, 0.1%, ±25ppm, 1/2W, 2512	MC007501
Resistor, Thin Film, 158K, 0.1%, ±25ppm, 1/2W, 2512	MC007461	Resistor, Thin Film, 453K, 0.1%, ±25ppm, 1/2W, 2512	MC007502
Resistor, Thin Film, 162K, 0.1%, ±25ppm, 1/2W, 2512	MC007462	Resistor, Thin Film, 464K, 0.1%, ±25ppm, 1/2W, 2512	MC007503
Resistor, Thin Film, 165K, 0.1%, ±25ppm, 1/2W, 2512	MC007463	Resistor, Thin Film, 475K, 0.1%, ±25ppm, 1/2W, 2512	MC007504
Resistor, Thin Film, 169K, 0.1%, ±25ppm, 1/2W, 2512	MC007464	Resistor, Thin Film, 487K, 0.1%, ±25ppm, 1/2W, 2512	MC007505
Resistor, Thin Film, 174K, 0.1%, ±25ppm, 1/2W, 2512	MC007465	Resistor, Thin Film, 499K, 0.1%, ±25ppm, 1/2W, 2512	MC007506
Resistor, Thin Film, 178K, 0.1%, ±25ppm, 1/2W, 2512	MC007466	Resistor, Thin Film, 511K, 0.1%, ±25ppm, 1/2W, 2512	MC007507
Resistor, Thin Film, 182K, 0.1%, ±25ppm, 1/2W, 2512	MC007467	Resistor, Thin Film, 523K, 0.1%, ±25ppm, 1/2W, 2512	MC007508
Resistor, Thin Film, 187K, 0.1%, ±25ppm, 1/2W, 2512	MC007468	Resistor, Thin Film, 536K, 0.1%, ±25ppm, 1/2W, 2512	MC007509
Resistor, Thin Film, 191K, 0.1%, ±25ppm, 1/2W, 2512	MC007469	Resistor, Thin Film, 549K, 0.1%, ±25ppm, 1/2W, 2512	MC007510
Resistor, Thin Film, 196K, 0.1%, ±25ppm, 1/2W, 2512	MC007470	Resistor, Thin Film, 562K, 0.1%, ±25ppm, 1/2W, 2512	MC007511
Resistor, Thin Film, 200K, 0.1%, ±25ppm, 1/2W, 2512	MC007471	Resistor, Thin Film, 576K, 0.1%, ±25ppm, 1/2W, 2512	MC007512
Resistor, Thin Film, 205K, 0.1%, ±25ppm, 1/2W, 2512	MC007472	Resistor, Thin Film, 590K, 0.1%, ±25ppm, 1/2W, 2512	MC007513
Resistor, Thin Film, 210K, 0.1%, ±25ppm, 1/2W, 2512	MC007473	Resistor, Thin Film, 604K, 0.1%, ±25ppm, 1/2W, 2512	MC007514
Resistor, Thin Film, 215K, 0.1%, ±25ppm, 1/2W, 2512	MC007474	Resistor, Thin Film, 619K, 0.1%, ±25ppm, 1/2W, 2512	MC007515

www.element14.com
www.farnell.com
www.newark.com



Thin Film Precision Chip Resistor

Description	Part Number	Description	Part Number
Resistor, Thin Film, 634K, 0.1%, ±25ppm, 1/2W, 2512	MC007516	Resistor, Thin Film, 13R, 0.1%, ±25ppm, 1/16W, 0402	MC007557
Resistor, Thin Film, 649K, 0.1%, ±25ppm, 1/2W, 2512	MC007517	Resistor, Thin Film, 13R3, 0.1%, ±25ppm, 1/16W, 0402	MC007558
Resistor, Thin Film, 665K, 0.1%, ±25ppm, 1/2W, 2512	MC007518	Resistor, Thin Film, 13R7, 0.1%, ±25ppm, 1/16W, 0402	MC007559
Resistor, Thin Film, 681K, 0.1%, ±25ppm, 1/2W, 2512	MC007519	Resistor, Thin Film, 14R, 0.1%, ±25ppm, 1/16W, 0402	MC007560
Resistor, Thin Film, 698K, 0.1%, ±25ppm, 1/2W, 2512	MC007520	Resistor, Thin Film, 14R3, 0.1%, ±25ppm, 1/16W, 0402	MC007561
Resistor, Thin Film, 715K, 0.1%, ±25ppm, 1/2W, 2512	MC007521	Resistor, Thin Film, 14R7, 0.1%, ±25ppm, 1/16W, 0402	MC007562
Resistor, Thin Film, 732K, 0.1%, ±25ppm, 1/2W, 2512	MC007522	Resistor, Thin Film, 15R, 0.1%, ±25ppm, 1/16W, 0402	MC007563
Resistor, Thin Film, 750K, 0.1%, ±25ppm, 1/2W, 2512	MC007523	Resistor, Thin Film, 15R4, 0.1%, ±25ppm, 1/16W, 0402	MC007564
Resistor, Thin Film, 768K, 0.1%, ±25ppm, 1/2W, 2512	MC007524	Resistor, Thin Film, 15R8, 0.1%, ±25ppm, 1/16W, 0402	MC007565
Resistor, Thin Film, 787K, 0.1%, ±25ppm, 1/2W, 2512	MC007525	Resistor, Thin Film, 16R2, 0.1%, ±25ppm, 1/16W, 0402	MC007566
Resistor, Thin Film, 806K, 0.1%, ±25ppm, 1/2W, 2512	MC007526	Resistor, Thin Film, 16R5, 0.1%, ±25ppm, 1/16W, 0402	MC007567
Resistor, Thin Film, 825K, 0.1%, ±25ppm, 1/2W, 2512	MC007527	Resistor, Thin Film, 16R9, 0.1%, ±25ppm, 1/16W, 0402	MC007568
Resistor, Thin Film, 845K, 0.1%, ±25ppm, 1/2W, 2512	MC007528	Resistor, Thin Film, 17R4, 0.1%, ±25ppm, 1/16W, 0402	MC007569
Resistor, Thin Film, 866K, 0.1%, ±25ppm, 1/2W, 2512	MC007529	Resistor, Thin Film, 17R8, 0.1%, ±25ppm, 1/16W, 0402	MC007570
Resistor, Thin Film, 887K, 0.1%, ±25ppm, 1/2W, 2512	MC007530	Resistor, Thin Film, 18R2, 0.1%, ±25ppm, 1/16W, 0402	MC007571
Resistor, Thin Film, 909K, 0.1%, ±25ppm, 1/2W, 2512	MC007531	Resistor, Thin Film, 18R7, 0.1%, ±25ppm, 1/16W, 0402	MC007572
Resistor, Thin Film, 931K, 0.1%, ±25ppm, 1/2W, 2512	MC007532	Resistor, Thin Film, 19R1, 0.1%, ±25ppm, 1/16W, 0402	MC007573
Resistor, Thin Film, 953K, 0.1%, ±25ppm, 1/2W, 2512	MC007533	Resistor, Thin Film, 19R6, 0.1%, ±25ppm, 1/16W, 0402	MC007574
Resistor, Thin Film, 976K, 0.1%, ±25ppm, 1/2W, 2512	MC007534	Resistor, Thin Film, 20R, 0.1%, ±25ppm, 1/16W, 0402	MC007575
Resistor, Thin Film, 1M, 0.1%, ±25ppm, 1/2W, 2512	MC007535	Resistor, Thin Film, 20R5, 0.1%, ±25ppm, 1/16W, 0402	MC007576
Resistor, Thin Film, 1M1, 0.1%, ±25ppm, 1/2W, 2512	MC007536	Resistor, Thin Film, 21R, 0.1%, ±25ppm, 1/16W, 0402	MC007577
Resistor, Thin Film, 1M2, 0.1%, ±25ppm, 1/2W, 2512	MC007537	Resistor, Thin Film, 21R5, 0.1%, ±25ppm, 1/16W, 0402	MC007578
Resistor, Thin Film, 1M3, 0.1%, ±25ppm, 1/2W, 2512	MC007538	Resistor, Thin Film, 22R1, 0.1%, ±25ppm, 1/16W, 0402	MC007579
Resistor, Thin Film, 1M5, 0.1%, ±25ppm, 1/2W, 2512	MC007539	Resistor, Thin Film, 22R6, 0.1%, ±25ppm, 1/16W, 0402	MC007580
Resistor, Thin Film, 1M6, 0.1%, ±25ppm, 1/2W, 2512	MC007540	Resistor, Thin Film, 23R2, 0.1%, ±25ppm, 1/16W, 0402	MC007581
Resistor, Thin Film, 1M8, 0.1%, ±25ppm, 1/2W, 2512	MC007541	Resistor, Thin Film, 23R7, 0.1%, ±25ppm, 1/16W, 0402	MC007582
Resistor, Thin Film, 2M, 0.1%, ±25ppm, 1/2W, 2512	MC007542	Resistor, Thin Film, 24R3, 0.1%, ±25ppm, 1/16W, 0402	MC007583
Resistor, Thin Film, 2M4, 0.1%, ±25ppm, 1/2W, 2512	MC007543	Resistor, Thin Film, 24R9, 0.1%, ±25ppm, 1/16W, 0402	MC007584
Resistor, Thin Film, 2M7, 0.1%, ±25ppm, 1/2W, 2512	MC007544	Resistor, Thin Film, 25R5, 0.1%, ±25ppm, 1/16W, 0402	MC007585
Resistor, Thin Film, 3M, 0.1%, ±25ppm, 1/2W, 2512	MC007545	Resistor, Thin Film, 26R1, 0.1%, ±25ppm, 1/16W, 0402	MC007586
Resistor, Thin Film, 10R, 0.1%, ±25ppm, 1/16W, 0402	MC007546	Resistor, Thin Film, 26R7, 0.1%, ±25ppm, 1/16W, 0402	MC007587
Resistor, Thin Film, 10R2, 0.1%, ±25ppm, 1/16W, 0402	MC007547	Resistor, Thin Film, 27R4, 0.1%, ±25ppm, 1/16W, 0402	MC007588
Resistor, Thin Film, 10R5, 0.1%, ±25ppm, 1/16W, 0402	MC007548	Resistor, Thin Film, 28R, 0.1%, ±25ppm, 1/16W, 0402	MC007589
Resistor, Thin Film, 10R7, 0.1%, ±25ppm, 1/16W, 0402	MC007549	Resistor, Thin Film, 29R4, 0.1%, ±25ppm, 1/16W, 0402	MC007590
Resistor, Thin Film, 11R, 0.1%, ±25ppm, 1/16W, 0402	MC007550	Resistor, Thin Film, 31R6, 0.1%, ±25ppm, 1/16W, 0402	MC007591
Resistor, Thin Film, 11R3, 0.1%, ±25ppm, 1/16W, 0402	MC007551	Resistor, Thin Film, 32R4, 0.1%, ±25ppm, 1/16W, 0402	MC007592
Resistor, Thin Film, 11R5, 0.1%, ±25ppm, 1/16W, 0402	MC007552	Resistor, Thin Film, 33R2, 0.1%, ±25ppm, 1/16W, 0402	MC007593
Resistor, Thin Film, 11R8, 0.1%, ±25ppm, 1/16W, 0402	MC007553	Resistor, Thin Film, 34R, 0.1%, ±25ppm, 1/16W, 0402	MC007594
Resistor, Thin Film, 12R1, 0.1%, ±25ppm, 1/16W, 0402	MC007554	Resistor, Thin Film, 34R8, 0.1%, ±25ppm, 1/16W, 0402	MC007595
Resistor, Thin Film, 12R4, 0.1%, ±25ppm, 1/16W, 0402	MC007555	Resistor, Thin Film, 35R7, 0.1%, ±25ppm, 1/16W, 0402	MC007596
Resistor, Thin Film, 12R7, 0.1%, ±25ppm, 1/16W, 0402	MC007556	Resistor, Thin Film, 36R5, 0.1%, ±25ppm, 1/16W, 0402	MC007597

www.element14.com
www.farnell.com
www.newark.com



Thin Film Precision Chip Resistor

Description	Part Number	Description	Part Number
Resistor, Thin Film, 37R4, 0.1%, ±25ppm, 1/16W, 0402	MC007598	Resistor, Thin Film, 100R, 0.1%, ±25ppm, 1/16W, 0402	MC007639
Resistor, Thin Film, 38R3, 0.1%, ±25ppm, 1/16W, 0402	MC007599	Resistor, Thin Film, 102R, 0.1%, ±25ppm, 1/16W, 0402	MC007640
Resistor, Thin Film, 39R2, 0.1%, ±25ppm, 1/16W, 0402	MC007600	Resistor, Thin Film, 105R, 0.1%, ±25ppm, 1/16W, 0402	MC007641
Resistor, Thin Film, 40R2, 0.1%, ±25ppm, 1/16W, 0402	MC007601	Resistor, Thin Film, 107R, 0.1%, ±25ppm, 1/16W, 0402	MC007642
Resistor, Thin Film, 41R2, 0.1%, ±25ppm, 1/16W, 0402	MC007602	Resistor, Thin Film, 110R, 0.1%, ±25ppm, 1/16W, 0402	MC007643
Resistor, Thin Film, 42R2, 0.1%, ±25ppm, 1/16W, 0402	MC007603	Resistor, Thin Film, 113R, 0.1%, ±25ppm, 1/16W, 0402	MC007644
Resistor, Thin Film, 43R2, 0.1%, ±25ppm, 1/16W, 0402	MC007604	Resistor, Thin Film, 115R, 0.1%, ±25ppm, 1/16W, 0402	MC007645
Resistor, Thin Film, 44R2, 0.1%, ±25ppm, 1/16W, 0402	MC007605	Resistor, Thin Film, 118R, 0.1%, ±25ppm, 1/16W, 0402	MC007646
Resistor, Thin Film, 45R3, 0.1%, ±25ppm, 1/16W, 0402	MC007606	Resistor, Thin Film, 121R, 0.1%, ±25ppm, 1/16W, 0402	MC007647
Resistor, Thin Film, 46R4, 0.1%, ±25ppm, 1/16W, 0402	MC007607	Resistor, Thin Film, 124R, 0.1%, ±25ppm, 1/16W, 0402	MC007648
Resistor, Thin Film, 47R5, 0.1%, ±25ppm, 1/16W, 0402	MC007608	Resistor, Thin Film, 127R, 0.1%, ±25ppm, 1/16W, 0402	MC007649
Resistor, Thin Film, 48R7, 0.1%, ±25ppm, 1/16W, 0402	MC007609	Resistor, Thin Film, 130R, 0.1%, ±25ppm, 1/16W, 0402	MC007650
Resistor, Thin Film, 49R9, 0.1%, ±25ppm, 1/16W, 0402	MC007610	Resistor, Thin Film, 133R, 0.1%, ±25ppm, 1/16W, 0402	MC007651
Resistor, Thin Film, 51R1, 0.1%, ±25ppm, 1/16W, 0402	MC007611	Resistor, Thin Film, 137R, 0.1%, ±25ppm, 1/16W, 0402	MC007652
Resistor, Thin Film, 52R3, 0.1%, ±25ppm, 1/16W, 0402	MC007612	Resistor, Thin Film, 140R, 0.1%, ±25ppm, 1/16W, 0402	MC007653
Resistor, Thin Film, 53R6, 0.1%, ±25ppm, 1/16W, 0402	MC007613	Resistor, Thin Film, 143R, 0.1%, ±25ppm, 1/16W, 0402	MC007654
Resistor, Thin Film, 54R9, 0.1%, ±25ppm, 1/16W, 0402	MC007614	Resistor, Thin Film, 147R, 0.1%, ±25ppm, 1/16W, 0402	MC007655
Resistor, Thin Film, 56R2, 0.1%, ±25ppm, 1/16W, 0402	MC007615	Resistor, Thin Film, 150R, 0.1%, ±25ppm, 1/16W, 0402	MC007656
Resistor, Thin Film, 57R6, 0.1%, ±25ppm, 1/16W, 0402	MC007616	Resistor, Thin Film, 154R, 0.1%, ±25ppm, 1/16W, 0402	MC007657
Resistor, Thin Film, 59R, 0.1%, ±25ppm, 1/16W, 0402	MC007617	Resistor, Thin Film, 158R, 0.1%, ±25ppm, 1/16W, 0402	MC007658
Resistor, Thin Film, 60R4, 0.1%, ±25ppm, 1/16W, 0402	MC007618	Resistor, Thin Film, 162R, 0.1%, ±25ppm, 1/16W, 0402	MC007659
Resistor, Thin Film, 61R9, 0.1%, ±25ppm, 1/16W, 0402	MC007619	Resistor, Thin Film, 165R, 0.1%, ±25ppm, 1/16W, 0402	MC007660
Resistor, Thin Film, 63R4, 0.1%, ±25ppm, 1/16W, 0402	MC007620	Resistor, Thin Film, 169R, 0.1%, ±25ppm, 1/16W, 0402	MC007661
Resistor, Thin Film, 64R9, 0.1%, ±25ppm, 1/16W, 0402	MC007621	Resistor, Thin Film, 174R, 0.1%, ±25ppm, 1/16W, 0402	MC007662
Resistor, Thin Film, 66R5, 0.1%, ±25ppm, 1/16W, 0402	MC007622	Resistor, Thin Film, 178R, 0.1%, ±25ppm, 1/16W, 0402	MC007663
Resistor, Thin Film, 68R1, 0.1%, ±25ppm, 1/16W, 0402	MC007623	Resistor, Thin Film, 182R, 0.1%, ±25ppm, 1/16W, 0402	MC007664
Resistor, Thin Film, 69R8, 0.1%, ±25ppm, 1/16W, 0402	MC007624	Resistor, Thin Film, 187R, 0.1%, ±25ppm, 1/16W, 0402	MC007665
Resistor, Thin Film, 71R5, 0.1%, ±25ppm, 1/16W, 0402	MC007625	Resistor, Thin Film, 191R, 0.1%, ±25ppm, 1/16W, 0402	MC007666
Resistor, Thin Film, 73R2, 0.1%, ±25ppm, 1/16W, 0402	MC007626	Resistor, Thin Film, 196R, 0.1%, ±25ppm, 1/16W, 0402	MC007667
Resistor, Thin Film, 75R, 0.1%, ±25ppm, 1/16W, 0402	MC007627	Resistor, Thin Film, 200R, 0.1%, ±25ppm, 1/16W, 0402	MC007668
Resistor, Thin Film, 76R8, 0.1%, ±25ppm, 1/16W, 0402	MC007628	Resistor, Thin Film, 205R, 0.1%, ±25ppm, 1/16W, 0402	MC007669
Resistor, Thin Film, 78R7, 0.1%, ±25ppm, 1/16W, 0402	MC007629	Resistor, Thin Film, 210R, 0.1%, ±25ppm, 1/16W, 0402	MC007670
Resistor, Thin Film, 80R6, 0.1%, ±25ppm, 1/16W, 0402	MC007630	Resistor, Thin Film, 215R, 0.1%, ±25ppm, 1/16W, 0402	MC007671
Resistor, Thin Film, 82R5, 0.1%, ±25ppm, 1/16W, 0402	MC007631	Resistor, Thin Film, 221R, 0.1%, ±25ppm, 1/16W, 0402	MC007672
Resistor, Thin Film, 84R5, 0.1%, ±25ppm, 1/16W, 0402	MC007632	Resistor, Thin Film, 226R, 0.1%, ±25ppm, 1/16W, 0402	MC007673
Resistor, Thin Film, 86R6, 0.1%, ±25ppm, 1/16W, 0402	MC007633	Resistor, Thin Film, 232R, 0.1%, ±25ppm, 1/16W, 0402	MC007674
Resistor, Thin Film, 88R7, 0.1%, ±25ppm, 1/16W, 0402	MC007634	Resistor, Thin Film, 237R, 0.1%, ±25ppm, 1/16W, 0402	MC007675
Resistor, Thin Film, 90R9, 0.1%, ±25ppm, 1/16W, 0402	MC007635	Resistor, Thin Film, 243R, 0.1%, ±25ppm, 1/16W, 0402	MC007676
Resistor, Thin Film, 93R1, 0.1%, ±25ppm, 1/16W, 0402	MC007636	Resistor, Thin Film, 249R, 0.1%, ±25ppm, 1/16W, 0402	MC007677
Resistor, Thin Film, 95R3, 0.1%, ±25ppm, 1/16W, 0402	MC007637	Resistor, Thin Film, 255R, 0.1%, ±25ppm, 1/16W, 0402	MC007678
Resistor, Thin Film, 97R6, 0.1%, ±25ppm, 1/16W, 0402	MC007638	Resistor, Thin Film, 261R, 0.1%, ±25ppm, 1/16W, 0402	MC007679

www.element14.com
www.farnell.com
www.newark.com



Thin Film Precision Chip Resistor

Description	Part Number	Description	Part Number
Resistor, Thin Film, 267R, 0.1%, ±25ppm, 1/16W, 0402	MC007680	Resistor, Thin Film, 768R, 0.1%, ±25ppm, 1/16W, 0402	MC007721
Resistor, Thin Film, 274R, 0.1%, ±25ppm, 1/16W, 0402	MC007681	Resistor, Thin Film, 787R, 0.1%, ±25ppm, 1/16W, 0402	MC007722
Resistor, Thin Film, 280R, 0.1%, ±25ppm, 1/16W, 0402	MC007682	Resistor, Thin Film, 806R, 0.1%, ±25ppm, 1/16W, 0402	MC007723
Resistor, Thin Film, 294R, 0.1%, ±25ppm, 1/16W, 0402	MC007683	Resistor, Thin Film, 825R, 0.1%, ±25ppm, 1/16W, 0402	MC007724
Resistor, Thin Film, 316R, 0.1%, ±25ppm, 1/16W, 0402	MC007684	Resistor, Thin Film, 845R, 0.1%, ±25ppm, 1/16W, 0402	MC007725
Resistor, Thin Film, 324R, 0.1%, ±25ppm, 1/16W, 0402	MC007685	Resistor, Thin Film, 866R, 0.1%, ±25ppm, 1/16W, 0402	MC007726
Resistor, Thin Film, 332R, 0.1%, ±25ppm, 1/16W, 0402	MC007686	Resistor, Thin Film, 887R, 0.1%, ±25ppm, 1/16W, 0402	MC007727
Resistor, Thin Film, 340R, 0.1%, ±25ppm, 1/16W, 0402	MC007687	Resistor, Thin Film, 909R, 0.1%, ±25ppm, 1/16W, 0402	MC007728
Resistor, Thin Film, 348R, 0.1%, ±25ppm, 1/16W, 0402	MC007688	Resistor, Thin Film, 931R, 0.1%, ±25ppm, 1/16W, 0402	MC007729
Resistor, Thin Film, 357R, 0.1%, ±25ppm, 1/16W, 0402	MC007689	Resistor, Thin Film, 953R, 0.1%, ±25ppm, 1/16W, 0402	MC007730
Resistor, Thin Film, 365R, 0.1%, ±25ppm, 1/16W, 0402	MC007690	Resistor, Thin Film, 976R, 0.1%, ±25ppm, 1/16W, 0402	MC007731
Resistor, Thin Film, 374R, 0.1%, ±25ppm, 1/16W, 0402	MC007691	Resistor, Thin Film, 1K, 0.1%, ±25ppm, 1/16W, 0402	MC007732
Resistor, Thin Film, 383R, 0.1%, ±25ppm, 1/16W, 0402	MC007692	Resistor, Thin Film, 1K02, 0.1%, ±25ppm, 1/16W, 0402	MC007733
Resistor, Thin Film, 392R, 0.1%, ±25ppm, 1/16W, 0402	MC007693	Resistor, Thin Film, 1K05, 0.1%, ±25ppm, 1/16W, 0402	MC007734
Resistor, Thin Film, 402R, 0.1%, ±25ppm, 1/16W, 0402	MC007694	Resistor, Thin Film, 1K07, 0.1%, ±25ppm, 1/16W, 0402	MC007735
Resistor, Thin Film, 412R, 0.1%, ±25ppm, 1/16W, 0402	MC007695	Resistor, Thin Film, 1K1, 0.1%, ±25ppm, 1/16W, 0402	MC007736
Resistor, Thin Film, 422R, 0.1%, ±25ppm, 1/16W, 0402	MC007696	Resistor, Thin Film, 1K13, 0.1%, ±25ppm, 1/16W, 0402	MC007737
Resistor, Thin Film, 432R, 0.1%, ±25ppm, 1/16W, 0402	MC007697	Resistor, Thin Film, 1K15, 0.1%, ±25ppm, 1/16W, 0402	MC007738
Resistor, Thin Film, 442R, 0.1%, ±25ppm, 1/16W, 0402	MC007698	Resistor, Thin Film, 1K18, 0.1%, ±25ppm, 1/16W, 0402	MC007739
Resistor, Thin Film, 453R, 0.1%, ±25ppm, 1/16W, 0402	MC007699	Resistor, Thin Film, 1K21, 0.1%, ±25ppm, 1/16W, 0402	MC007740
Resistor, Thin Film, 464R, 0.1%, ±25ppm, 1/16W, 0402	MC007700	Resistor, Thin Film, 1K24, 0.1%, ±25ppm, 1/16W, 0402	MC007741
Resistor, Thin Film, 475R, 0.1%, ±25ppm, 1/16W, 0402	MC007701	Resistor, Thin Film, 1K27, 0.1%, ±25ppm, 1/16W, 0402	MC007742
Resistor, Thin Film, 487R, 0.1%, ±25ppm, 1/16W, 0402	MC007702	Resistor, Thin Film, 1K3, 0.1%, ±25ppm, 1/16W, 0402	MC007743
Resistor, Thin Film, 499R, 0.1%, ±25ppm, 1/16W, 0402	MC007703	Resistor, Thin Film, 1K33, 0.1%, ±25ppm, 1/16W, 0402	MC007744
Resistor, Thin Film, 511R, 0.1%, ±25ppm, 1/16W, 0402	MC007704	Resistor, Thin Film, 1K37, 0.1%, ±25ppm, 1/16W, 0402	MC007745
Resistor, Thin Film, 523R, 0.1%, ±25ppm, 1/16W, 0402	MC007705	Resistor, Thin Film, 1K4, 0.1%, ±25ppm, 1/16W, 0402	MC007746
Resistor, Thin Film, 536R, 0.1%, ±25ppm, 1/16W, 0402	MC007706	Resistor, Thin Film, 1K43, 0.1%, ±25ppm, 1/16W, 0402	MC007747
Resistor, Thin Film, 549R, 0.1%, ±25ppm, 1/16W, 0402	MC007707	Resistor, Thin Film, 1K47, 0.1%, ±25ppm, 1/16W, 0402	MC007748
Resistor, Thin Film, 562R, 0.1%, ±25ppm, 1/16W, 0402	MC007708	Resistor, Thin Film, 1K5, 0.1%, ±25ppm, 1/16W, 0402	MC007749
Resistor, Thin Film, 576R, 0.1%, ±25ppm, 1/16W, 0402	MC007709	Resistor, Thin Film, 1K54, 0.1%, ±25ppm, 1/16W, 0402	MC007750
Resistor, Thin Film, 590R, 0.1%, ±25ppm, 1/16W, 0402	MC007710	Resistor, Thin Film, 1K58, 0.1%, ±25ppm, 1/16W, 0402	MC007751
Resistor, Thin Film, 604R, 0.1%, ±25ppm, 1/16W, 0402	MC007711	Resistor, Thin Film, 1K62, 0.1%, ±25ppm, 1/16W, 0402	MC007752
Resistor, Thin Film, 619R, 0.1%, ±25ppm, 1/16W, 0402	MC007712	Resistor, Thin Film, 1K65, 0.1%, ±25ppm, 1/16W, 0402	MC007753
Resistor, Thin Film, 634R, 0.1%, ±25ppm, 1/16W, 0402	MC007713	Resistor, Thin Film, 1K69, 0.1%, ±25ppm, 1/16W, 0402	MC007754
Resistor, Thin Film, 649R, 0.1%, ±25ppm, 1/16W, 0402	MC007714	Resistor, Thin Film, 1K74, 0.1%, ±25ppm, 1/16W, 0402	MC007755
Resistor, Thin Film, 665R, 0.1%, ±25ppm, 1/16W, 0402	MC007715	Resistor, Thin Film, 1K78, 0.1%, ±25ppm, 1/16W, 0402	MC007756
Resistor, Thin Film, 681R, 0.1%, ±25ppm, 1/16W, 0402	MC007716	Resistor, Thin Film, 1K82, 0.1%, ±25ppm, 1/16W, 0402	MC007757
Resistor, Thin Film, 698R, 0.1%, ±25ppm, 1/16W, 0402	MC007717	Resistor, Thin Film, 1K87, 0.1%, ±25ppm, 1/16W, 0402	MC007758
Resistor, Thin Film, 715R, 0.1%, ±25ppm, 1/16W, 0402	MC007718	Resistor, Thin Film, 1K91, 0.1%, ±25ppm, 1/16W, 0402	MC007759
Resistor, Thin Film, 732R, 0.1%, ±25ppm, 1/16W, 0402	MC007719	Resistor, Thin Film, 1K96, 0.1%, ±25ppm, 1/16W, 0402	MC007760
Resistor, Thin Film, 750R, 0.1%, ±25ppm, 1/16W, 0402	MC007720	Resistor, Thin Film, 2K, 0.1%, ±25ppm, 1/16W, 0402	MC007761

Thin Film Precision Chip Resistor

Description	Part Number	Description	Part Number
Resistor, Thin Film, 2K05, 0.1%, ±25ppm, 1/16W, 0402	MC007762	Resistor, Thin Film, 5K9, 0.1%, ±25ppm, 1/16W, 0402	MC007803
Resistor, Thin Film, 2K1, 0.1%, ±25ppm, 1/16W, 0402	MC007763	Resistor, Thin Film, 6K04, 0.1%, ±25ppm, 1/16W, 0402	MC007804
Resistor, Thin Film, 2K15, 0.1%, ±25ppm, 1/16W, 0402	MC007764	Resistor, Thin Film, 6K19, 0.1%, ±25ppm, 1/16W, 0402	MC007805
Resistor, Thin Film, 2K21, 0.1%, ±25ppm, 1/16W, 0402	MC007765	Resistor, Thin Film, 6K34, 0.1%, ±25ppm, 1/16W, 0402	MC007806
Resistor, Thin Film, 2K26, 0.1%, ±25ppm, 1/16W, 0402	MC007766	Resistor, Thin Film, 6K49, 0.1%, ±25ppm, 1/16W, 0402	MC007807
Resistor, Thin Film, 2K32, 0.1%, ±25ppm, 1/16W, 0402	MC007767	Resistor, Thin Film, 6K65, 0.1%, ±25ppm, 1/16W, 0402	MC007808
Resistor, Thin Film, 2K37, 0.1%, ±25ppm, 1/16W, 0402	MC007768	Resistor, Thin Film, 6K81, 0.1%, ±25ppm, 1/16W, 0402	MC007809
Resistor, Thin Film, 2K43, 0.1%, ±25ppm, 1/16W, 0402	MC007769	Resistor, Thin Film, 6K98, 0.1%, ±25ppm, 1/16W, 0402	MC007810
Resistor, Thin Film, 2K49, 0.1%, ±25ppm, 1/16W, 0402	MC007770	Resistor, Thin Film, 7K15, 0.1%, ±25ppm, 1/16W, 0402	MC007811
Resistor, Thin Film, 2K55, 0.1%, ±25ppm, 1/16W, 0402	MC007771	Resistor, Thin Film, 7K32, 0.1%, ±25ppm, 1/16W, 0402	MC007812
Resistor, Thin Film, 2K61, 0.1%, ±25ppm, 1/16W, 0402	MC007772	Resistor, Thin Film, 7K5, 0.1%, ±25ppm, 1/16W, 0402	MC007813
Resistor, Thin Film, 2K67, 0.1%, ±25ppm, 1/16W, 0402	MC007773	Resistor, Thin Film, 7K68, 0.1%, ±25ppm, 1/16W, 0402	MC007814
Resistor, Thin Film, 2K74, 0.1%, ±25ppm, 1/16W, 0402	MC007774	Resistor, Thin Film, 7K87, 0.1%, ±25ppm, 1/16W, 0402	MC007815
Resistor, Thin Film, 2K8, 0.1%, ±25ppm, 1/16W, 0402	MC007775	Resistor, Thin Film, 8K06, 0.1%, ±25ppm, 1/16W, 0402	MC007816
Resistor, Thin Film, 2K94, 0.1%, ±25ppm, 1/16W, 0402	MC007776	Resistor, Thin Film, 8K25, 0.1%, ±25ppm, 1/16W, 0402	MC007817
Resistor, Thin Film, 3K16, 0.1%, ±25ppm, 1/16W, 0402	MC007777	Resistor, Thin Film, 8K45, 0.1%, ±25ppm, 1/16W, 0402	MC007818
Resistor, Thin Film, 3K24, 0.1%, ±25ppm, 1/16W, 0402	MC007778	Resistor, Thin Film, 8K66, 0.1%, ±25ppm, 1/16W, 0402	MC007819
Resistor, Thin Film, 3K32, 0.1%, ±25ppm, 1/16W, 0402	MC007779	Resistor, Thin Film, 8K87, 0.1%, ±25ppm, 1/16W, 0402	MC007820
Resistor, Thin Film, 3K4, 0.1%, ±25ppm, 1/16W, 0402	MC007780	Resistor, Thin Film, 9K09, 0.1%, ±25ppm, 1/16W, 0402	MC007821
Resistor, Thin Film, 3K48, 0.1%, ±25ppm, 1/16W, 0402	MC007781	Resistor, Thin Film, 9K31, 0.1%, ±25ppm, 1/16W, 0402	MC007822
Resistor, Thin Film, 3K57, 0.1%, ±25ppm, 1/16W, 0402	MC007782	Resistor, Thin Film, 9K53, 0.1%, ±25ppm, 1/16W, 0402	MC007823
Resistor, Thin Film, 3K65, 0.1%, ±25ppm, 1/16W, 0402	MC007783	Resistor, Thin Film, 9K76, 0.1%, ±25ppm, 1/16W, 0402	MC007824
Resistor, Thin Film, 3K74, 0.1%, ±25ppm, 1/16W, 0402	MC007784	Resistor, Thin Film, 10K, 0.1%, ±25ppm, 1/16W, 0402	MC007825
Resistor, Thin Film, 3K83, 0.1%, ±25ppm, 1/16W, 0402	MC007785	Resistor, Thin Film, 10K2, 0.1%, ±25ppm, 1/16W, 0402	MC007826
Resistor, Thin Film, 3K92, 0.1%, ±25ppm, 1/16W, 0402	MC007786	Resistor, Thin Film, 10K5, 0.1%, ±25ppm, 1/16W, 0402	MC007827
Resistor, Thin Film, 4K02, 0.1%, ±25ppm, 1/16W, 0402	MC007787	Resistor, Thin Film, 10K7, 0.1%, ±25ppm, 1/16W, 0402	MC007828
Resistor, Thin Film, 4K12, 0.1%, ±25ppm, 1/16W, 0402	MC007788	Resistor, Thin Film, 11K, 0.1%, ±25ppm, 1/16W, 0402	MC007829
Resistor, Thin Film, 4K22, 0.1%, ±25ppm, 1/16W, 0402	MC007789	Resistor, Thin Film, 11K3, 0.1%, ±25ppm, 1/16W, 0402	MC007830
Resistor, Thin Film, 4K32, 0.1%, ±25ppm, 1/16W, 0402	MC007790	Resistor, Thin Film, 11K5, 0.1%, ±25ppm, 1/16W, 0402	MC007831
Resistor, Thin Film, 4K42, 0.1%, ±25ppm, 1/16W, 0402	MC007791	Resistor, Thin Film, 11K8, 0.1%, ±25ppm, 1/16W, 0402	MC007832
Resistor, Thin Film, 4K53, 0.1%, ±25ppm, 1/16W, 0402	MC007792	Resistor, Thin Film, 12K1, 0.1%, ±25ppm, 1/16W, 0402	MC007833
Resistor, Thin Film, 4K64, 0.1%, ±25ppm, 1/16W, 0402	MC007793	Resistor, Thin Film, 12K4, 0.1%, ±25ppm, 1/16W, 0402	MC007834
Resistor, Thin Film, 4K75, 0.1%, ±25ppm, 1/16W, 0402	MC007794	Resistor, Thin Film, 12K7, 0.1%, ±25ppm, 1/16W, 0402	MC007835
Resistor, Thin Film, 4K87, 0.1%, ±25ppm, 1/16W, 0402	MC007795	Resistor, Thin Film, 13K, 0.1%, ±25ppm, 1/16W, 0402	MC007836
Resistor, Thin Film, 4K99, 0.1%, ±25ppm, 1/16W, 0402	MC007796	Resistor, Thin Film, 13K3, 0.1%, ±25ppm, 1/16W, 0402	MC007837
Resistor, Thin Film, 5K11, 0.1%, ±25ppm, 1/16W, 0402	MC007797	Resistor, Thin Film, 13K7, 0.1%, ±25ppm, 1/16W, 0402	MC007838
Resistor, Thin Film, 5K23, 0.1%, ±25ppm, 1/16W, 0402	MC007798	Resistor, Thin Film, 14K, 0.1%, ±25ppm, 1/16W, 0402	MC007839
Resistor, Thin Film, 5K36, 0.1%, ±25ppm, 1/16W, 0402	MC007799	Resistor, Thin Film, 14K3, 0.1%, ±25ppm, 1/16W, 0402	MC007840
Resistor, Thin Film, 5K49, 0.1%, ±25ppm, 1/16W, 0402	MC007800	Resistor, Thin Film, 14K7, 0.1%, ±25ppm, 1/16W, 0402	MC007841
Resistor, Thin Film, 5K62, 0.1%, ±25ppm, 1/16W, 0402	MC007801	Resistor, Thin Film, 15K, 0.1%, ±25ppm, 1/16W, 0402	MC007842
Resistor, Thin Film, 5K76, 0.1%, ±25ppm, 1/16W, 0402	MC007802	Resistor, Thin Film, 15K4, 0.1%, ±25ppm, 1/16W, 0402	MC007843

www.element14.com
www.farnell.com
www.newark.com



Thin Film Precision Chip Resistor

Description	Part Number	Description	Part Number
Resistor, Thin Film, 15K8, 0.1%, ±25ppm, 1/16W, 0402	MC007844	Resistor, Thin Film, 45K3, 0.1%, ±25ppm, 1/16W, 0402	MC007885
Resistor, Thin Film, 16K2, 0.1%, ±25ppm, 1/16W, 0402	MC007845	Resistor, Thin Film, 46K4, 0.1%, ±25ppm, 1/16W, 0402	MC007886
Resistor, Thin Film, 16K5, 0.1%, ±25ppm, 1/16W, 0402	MC007846	Resistor, Thin Film, 47K5, 0.1%, ±25ppm, 1/16W, 0402	MC007887
Resistor, Thin Film, 16K9, 0.1%, ±25ppm, 1/16W, 0402	MC007847	Resistor, Thin Film, 48K7, 0.1%, ±25ppm, 1/16W, 0402	MC007888
Resistor, Thin Film, 17K4, 0.1%, ±25ppm, 1/16W, 0402	MC007848	Resistor, Thin Film, 49K9, 0.1%, ±25ppm, 1/16W, 0402	MC007889
Resistor, Thin Film, 17K8, 0.1%, ±25ppm, 1/16W, 0402	MC007849	Resistor, Thin Film, 51K1, 0.1%, ±25ppm, 1/16W, 0402	MC007890
Resistor, Thin Film, 18K2, 0.1%, ±25ppm, 1/16W, 0402	MC007850	Resistor, Thin Film, 52K3, 0.1%, ±25ppm, 1/16W, 0402	MC007891
Resistor, Thin Film, 18K7, 0.1%, ±25ppm, 1/16W, 0402	MC007851	Resistor, Thin Film, 53K6, 0.1%, ±25ppm, 1/16W, 0402	MC007892
Resistor, Thin Film, 19K1, 0.1%, ±25ppm, 1/16W, 0402	MC007852	Resistor, Thin Film, 54K9, 0.1%, ±25ppm, 1/16W, 0402	MC007893
Resistor, Thin Film, 19K6, 0.1%, ±25ppm, 1/16W, 0402	MC007853	Resistor, Thin Film, 56K2, 0.1%, ±25ppm, 1/16W, 0402	MC007894
Resistor, Thin Film, 20K, 0.1%, ±25ppm, 1/16W, 0402	MC007854	Resistor, Thin Film, 57K6, 0.1%, ±25ppm, 1/16W, 0402	MC007895
Resistor, Thin Film, 20K5, 0.1%, ±25ppm, 1/16W, 0402	MC007855	Resistor, Thin Film, 59K, 0.1%, ±25ppm, 1/16W, 0402	MC007896
Resistor, Thin Film, 21K, 0.1%, ±25ppm, 1/16W, 0402	MC007856	Resistor, Thin Film, 60K4, 0.1%, ±25ppm, 1/16W, 0402	MC007897
Resistor, Thin Film, 21K5, 0.1%, ±25ppm, 1/16W, 0402	MC007857	Resistor, Thin Film, 61K9, 0.1%, ±25ppm, 1/16W, 0402	MC007898
Resistor, Thin Film, 22K1, 0.1%, ±25ppm, 1/16W, 0402	MC007858	Resistor, Thin Film, 63K4, 0.1%, ±25ppm, 1/16W, 0402	MC007899
Resistor, Thin Film, 22K6, 0.1%, ±25ppm, 1/16W, 0402	MC007859	Resistor, Thin Film, 64K9, 0.1%, ±25ppm, 1/16W, 0402	MC007900
Resistor, Thin Film, 23K2, 0.1%, ±25ppm, 1/16W, 0402	MC007860	Resistor, Thin Film, 66K5, 0.1%, ±25ppm, 1/16W, 0402	MC007901
Resistor, Thin Film, 23K7, 0.1%, ±25ppm, 1/16W, 0402	MC007861	Resistor, Thin Film, 68K1, 0.1%, ±25ppm, 1/16W, 0402	MC007902
Resistor, Thin Film, 24K3, 0.1%, ±25ppm, 1/16W, 0402	MC007862	Resistor, Thin Film, 69K8, 0.1%, ±25ppm, 1/16W, 0402	MC007903
Resistor, Thin Film, 24K9, 0.1%, ±25ppm, 1/16W, 0402	MC007863	Resistor, Thin Film, 71K5, 0.1%, ±25ppm, 1/16W, 0402	MC007904
Resistor, Thin Film, 25K5, 0.1%, ±25ppm, 1/16W, 0402	MC007864	Resistor, Thin Film, 73K2, 0.1%, ±25ppm, 1/16W, 0402	MC007905
Resistor, Thin Film, 26K1, 0.1%, ±25ppm, 1/16W, 0402	MC007865	Resistor, Thin Film, 75K, 0.1%, ±25ppm, 1/16W, 0402	MC007906
Resistor, Thin Film, 26K7, 0.1%, ±25ppm, 1/16W, 0402	MC007866	Resistor, Thin Film, 76K8, 0.1%, ±25ppm, 1/16W, 0402	MC007907
Resistor, Thin Film, 27K4, 0.1%, ±25ppm, 1/16W, 0402	MC007867	Resistor, Thin Film, 78K7, 0.1%, ±25ppm, 1/16W, 0402	MC007908
Resistor, Thin Film, 28K, 0.1%, ±25ppm, 1/16W, 0402	MC007868	Resistor, Thin Film, 80K6, 0.1%, ±25ppm, 1/16W, 0402	MC007909
Resistor, Thin Film, 29K4, 0.1%, ±25ppm, 1/16W, 0402	MC007869	Resistor, Thin Film, 82K5, 0.1%, ±25ppm, 1/16W, 0402	MC007910
Resistor, Thin Film, 31K6, 0.1%, ±25ppm, 1/16W, 0402	MC007870	Resistor, Thin Film, 84K5, 0.1%, ±25ppm, 1/16W, 0402	MC007911
Resistor, Thin Film, 32K4, 0.1%, ±25ppm, 1/16W, 0402	MC007871	Resistor, Thin Film, 86K6, 0.1%, ±25ppm, 1/16W, 0402	MC007912
Resistor, Thin Film, 33K2, 0.1%, ±25ppm, 1/16W, 0402	MC007872	Resistor, Thin Film, 88K7, 0.1%, ±25ppm, 1/16W, 0402	MC007913
Resistor, Thin Film, 34K, 0.1%, ±25ppm, 1/16W, 0402	MC007873	Resistor, Thin Film, 90K9, 0.1%, ±25ppm, 1/16W, 0402	MC007914
Resistor, Thin Film, 34K8, 0.1%, ±25ppm, 1/16W, 0402	MC007874	Resistor, Thin Film, 93K1, 0.1%, ±25ppm, 1/16W, 0402	MC007915
Resistor, Thin Film, 35K7, 0.1%, ±25ppm, 1/16W, 0402	MC007875	Resistor, Thin Film, 95K3, 0.1%, ±25ppm, 1/16W, 0402	MC007916
Resistor, Thin Film, 36K5, 0.1%, ±25ppm, 1/16W, 0402	MC007876	Resistor, Thin Film, 97K6, 0.1%, ±25ppm, 1/16W, 0402	MC007917
Resistor, Thin Film, 37K4, 0.1%, ±25ppm, 1/16W, 0402	MC007877	Resistor, Thin Film, 100K, 0.1%, ±25ppm, 1/16W, 0402	MC007918
Resistor, Thin Film, 38K3, 0.1%, ±25ppm, 1/16W, 0402	MC007878	Resistor, Thin Film, 102K, 0.1%, ±25ppm, 1/16W, 0402	MC007919
Resistor, Thin Film, 39K2, 0.1%, ±25ppm, 1/16W, 0402	MC007879	Resistor, Thin Film, 105K, 0.1%, ±25ppm, 1/16W, 0402	MC007920
Resistor, Thin Film, 40K2, 0.1%, ±25ppm, 1/16W, 0402	MC007880	Resistor, Thin Film, 107K, 0.1%, ±25ppm, 1/16W, 0402	MC007921
Resistor, Thin Film, 41K2, 0.1%, ±25ppm, 1/16W, 0402	MC007881	Resistor, Thin Film, 110K, 0.1%, ±25ppm, 1/16W, 0402	MC007922
Resistor, Thin Film, 42K2, 0.1%, ±25ppm, 1/16W, 0402	MC007882	Resistor, Thin Film, 113K, 0.1%, ±25ppm, 1/16W, 0402	MC007923
Resistor, Thin Film, 43K2, 0.1%, ±25ppm, 1/16W, 0402	MC007883	Resistor, Thin Film, 115K, 0.1%, ±25ppm, 1/16W, 0402	MC007924
Resistor, Thin Film, 44K2, 0.1%, ±25ppm, 1/16W, 0402	MC007884	Resistor, Thin Film, 118K, 0.1%, ±25ppm, 1/16W, 0402	MC007925

www.element14.com
www.farnell.com
www.newark.com



Thin Film Precision Chip Resistor

Description	Part Number	Description	Part Number
Resistor, Thin Film, 121K, 0.1%, ±25ppm, 1/16W, 0402	MC007926	Resistor, Thin Film, 348K, 0.1%, ±25ppm, 1/16W, 0402	MC007967
Resistor, Thin Film, 124K, 0.1%, ±25ppm, 1/16W, 0402	MC007927	Resistor, Thin Film, 357K, 0.1%, ±25ppm, 1/16W, 0402	MC007968
Resistor, Thin Film, 127K, 0.1%, ±25ppm, 1/16W, 0402	MC007928	Resistor, Thin Film, 365K, 0.1%, ±25ppm, 1/16W, 0402	MC007969
Resistor, Thin Film, 130K, 0.1%, ±25ppm, 1/16W, 0402	MC007929	Resistor, Thin Film, 374K, 0.1%, ±25ppm, 1/16W, 0402	MC007970
Resistor, Thin Film, 133K, 0.1%, ±25ppm, 1/16W, 0402	MC007930	Resistor, Thin Film, 383K, 0.1%, ±25ppm, 1/16W, 0402	MC007971
Resistor, Thin Film, 137K, 0.1%, ±25ppm, 1/16W, 0402	MC007931	Resistor, Thin Film, 392K, 0.1%, ±25ppm, 1/16W, 0402	MC007972
Resistor, Thin Film, 140K, 0.1%, ±25ppm, 1/16W, 0402	MC007932	Resistor, Thin Film, 402K, 0.1%, ±25ppm, 1/16W, 0402	MC007973
Resistor, Thin Film, 143K, 0.1%, ±25ppm, 1/16W, 0402	MC007933	Resistor, Thin Film, 412K, 0.1%, ±25ppm, 1/16W, 0402	MC007974
Resistor, Thin Film, 147K, 0.1%, ±25ppm, 1/16W, 0402	MC007934	Resistor, Thin Film, 422K, 0.1%, ±25ppm, 1/16W, 0402	MC007975
Resistor, Thin Film, 150K, 0.1%, ±25ppm, 1/16W, 0402	MC007935	Resistor, Thin Film, 432K, 0.1%, ±25ppm, 1/16W, 0402	MC007976
Resistor, Thin Film, 154K, 0.1%, ±25ppm, 1/16W, 0402	MC007936	Resistor, Thin Film, 442K, 0.1%, ±25ppm, 1/16W, 0402	MC007977
Resistor, Thin Film, 158K, 0.1%, ±25ppm, 1/16W, 0402	MC007937	Resistor, Thin Film, 453K, 0.1%, ±25ppm, 1/16W, 0402	MC007978
Resistor, Thin Film, 162K, 0.1%, ±25ppm, 1/16W, 0402	MC007938	Resistor, Thin Film, 464K, 0.1%, ±25ppm, 1/16W, 0402	MC007979
Resistor, Thin Film, 165K, 0.1%, ±25ppm, 1/16W, 0402	MC007939	Resistor, Thin Film, 475K, 0.1%, ±25ppm, 1/16W, 0402	MC007980
Resistor, Thin Film, 169K, 0.1%, ±25ppm, 1/16W, 0402	MC007940	Resistor, Thin Film, 487K, 0.1%, ±25ppm, 1/16W, 0402	MC007981
Resistor, Thin Film, 174K, 0.1%, ±25ppm, 1/16W, 0402	MC007941	Resistor, Thin Film, 499K, 0.1%, ±25ppm, 1/16W, 0402	MC007982
Resistor, Thin Film, 178K, 0.1%, ±25ppm, 1/16W, 0402	MC007942	Resistor, Thin Film, 511K, 0.1%, ±25ppm, 1/16W, 0402	MC007983
Resistor, Thin Film, 182K, 0.1%, ±25ppm, 1/16W, 0402	MC007943	Resistor, Thin Film, 4R7, 0.1%, ±25ppm, 1/16W, 0603	MC007984
Resistor, Thin Film, 187K, 0.1%, ±25ppm, 1/16W, 0402	MC007944	Resistor, Thin Film, 5R1, 0.1%, ±25ppm, 1/16W, 0603	MC007985
Resistor, Thin Film, 191K, 0.1%, ±25ppm, 1/16W, 0402	MC007945	Resistor, Thin Film, 5R6, 0.1%, ±25ppm, 1/16W, 0603	MC007986
Resistor, Thin Film, 196K, 0.1%, ±25ppm, 1/16W, 0402	MC007946	Resistor, Thin Film, 6R2, 0.1%, ±25ppm, 1/16W, 0603	MC007987
Resistor, Thin Film, 200K, 0.1%, ±25ppm, 1/16W, 0402	MC007947	Resistor, Thin Film, 6R8, 0.1%, ±25ppm, 1/16W, 0603	MC007988
Resistor, Thin Film, 205K, 0.1%, ±25ppm, 1/16W, 0402	MC007948	Resistor, Thin Film, 7R5, 0.1%, ±25ppm, 1/16W, 0603	MC007989
Resistor, Thin Film, 210K, 0.1%, ±25ppm, 1/16W, 0402	MC007949	Resistor, Thin Film, 8R2, 0.1%, ±25ppm, 1/16W, 0603	MC007990
Resistor, Thin Film, 215K, 0.1%, ±25ppm, 1/16W, 0402	MC007950	Resistor, Thin Film, 9R1, 0.1%, ±25ppm, 1/16W, 0603	MC007991
Resistor, Thin Film, 221K, 0.1%, ±25ppm, 1/16W, 0402	MC007951	Resistor, Thin Film, 10R, 0.1%, ±25ppm, 1/16W, 0603	MC007992
Resistor, Thin Film, 226K, 0.1%, ±25ppm, 1/16W, 0402	MC007952	Resistor, Thin Film, 10R2, 0.1%, ±25ppm, 1/16W, 0603	MC007993
Resistor, Thin Film, 232K, 0.1%, ±25ppm, 1/16W, 0402	MC007953	Resistor, Thin Film, 10R5, 0.1%, ±25ppm, 1/16W, 0603	MC007994
Resistor, Thin Film, 237K, 0.1%, ±25ppm, 1/16W, 0402	MC007954	Resistor, Thin Film, 10R7, 0.1%, ±25ppm, 1/16W, 0603	MC007995
Resistor, Thin Film, 243K, 0.1%, ±25ppm, 1/16W, 0402	MC007955	Resistor, Thin Film, 11R, 0.1%, ±25ppm, 1/16W, 0603	MC007996
Resistor, Thin Film, 249K, 0.1%, ±25ppm, 1/16W, 0402	MC007956	Resistor, Thin Film, 11R3, 0.1%, ±25ppm, 1/16W, 0603	MC007997
Resistor, Thin Film, 255K, 0.1%, ±25ppm, 1/16W, 0402	MC007957	Resistor, Thin Film, 11R5, 0.1%, ±25ppm, 1/16W, 0603	MC007998
Resistor, Thin Film, 261K, 0.1%, ±25ppm, 1/16W, 0402	MC007958	Resistor, Thin Film, 11R8, 0.1%, ±25ppm, 1/16W, 0603	MC007999
Resistor, Thin Film, 267K, 0.1%, ±25ppm, 1/16W, 0402	MC007959	Resistor, Thin Film, 12R1, 0.1%, ±25ppm, 1/16W, 0603	MC008000
Resistor, Thin Film, 274K, 0.1%, ±25ppm, 1/16W, 0402	MC007960	Resistor, Thin Film, 12R4, 0.1%, ±25ppm, 1/16W, 0603	MC008001
Resistor, Thin Film, 280K, 0.1%, ±25ppm, 1/16W, 0402	MC007961	Resistor, Thin Film, 12R7, 0.1%, ±25ppm, 1/16W, 0603	MC008002
Resistor, Thin Film, 294K, 0.1%, ±25ppm, 1/16W, 0402	MC007962	Resistor, Thin Film, 13R, 0.1%, ±25ppm, 1/16W, 0603	MC008003
Resistor, Thin Film, 316K, 0.1%, ±25ppm, 1/16W, 0402	MC007963	Resistor, Thin Film, 13R3, 0.1%, ±25ppm, 1/16W, 0603	MC008004
Resistor, Thin Film, 324K, 0.1%, ±25ppm, 1/16W, 0402	MC007964	Resistor, Thin Film, 13R7, 0.1%, ±25ppm, 1/16W, 0603	MC008005
Resistor, Thin Film, 332K, 0.1%, ±25ppm, 1/16W, 0402	MC007965	Resistor, Thin Film, 14R, 0.1%, ±25ppm, 1/16W, 0603	MC008006
Resistor, Thin Film, 340K, 0.1%, ±25ppm, 1/16W, 0402	MC007966	Resistor, Thin Film, 14R3, 0.1%, ±25ppm, 1/16W, 0603	MC008007

www.element14.com
www.farnell.com
www.newark.com



Thin Film Precision Chip Resistor

Description	Part Number	Description	Part Number
Resistor, Thin Film, 14R7, 0.1%, ±25ppm, 1/16W, 0603	MC008008	Resistor, Thin Film, 42R2, 0.1%, ±25ppm, 1/16W, 0603	MC008049
Resistor, Thin Film, 15R, 0.1%, ±25ppm, 1/16W, 0603	MC008009	Resistor, Thin Film, 43R2, 0.1%, ±25ppm, 1/16W, 0603	MC008050
Resistor, Thin Film, 15R4, 0.1%, ±25ppm, 1/16W, 0603	MC008010	Resistor, Thin Film, 44R2, 0.1%, ±25ppm, 1/16W, 0603	MC008051
Resistor, Thin Film, 15R8, 0.1%, ±25ppm, 1/16W, 0603	MC008011	Resistor, Thin Film, 45R3, 0.1%, ±25ppm, 1/16W, 0603	MC008052
Resistor, Thin Film, 16R2, 0.1%, ±25ppm, 1/16W, 0603	MC008012	Resistor, Thin Film, 46R4, 0.1%, ±25ppm, 1/16W, 0603	MC008053
Resistor, Thin Film, 16R5, 0.1%, ±25ppm, 1/16W, 0603	MC008013	Resistor, Thin Film, 47R5, 0.1%, ±25ppm, 1/16W, 0603	MC008054
Resistor, Thin Film, 16R9, 0.1%, ±25ppm, 1/16W, 0603	MC008014	Resistor, Thin Film, 48R7, 0.1%, ±25ppm, 1/16W, 0603	MC008055
Resistor, Thin Film, 17R4, 0.1%, ±25ppm, 1/16W, 0603	MC008015	Resistor, Thin Film, 49R9, 0.1%, ±25ppm, 1/16W, 0603	MC008056
Resistor, Thin Film, 17R8, 0.1%, ±25ppm, 1/16W, 0603	MC008016	Resistor, Thin Film, 51R1, 0.1%, ±25ppm, 1/16W, 0603	MC008057
Resistor, Thin Film, 18R2, 0.1%, ±25ppm, 1/16W, 0603	MC008017	Resistor, Thin Film, 52R3, 0.1%, ±25ppm, 1/16W, 0603	MC008058
Resistor, Thin Film, 18R7, 0.1%, ±25ppm, 1/16W, 0603	MC008018	Resistor, Thin Film, 53R6, 0.1%, ±25ppm, 1/16W, 0603	MC008059
Resistor, Thin Film, 19R1, 0.1%, ±25ppm, 1/16W, 0603	MC008019	Resistor, Thin Film, 54R9, 0.1%, ±25ppm, 1/16W, 0603	MC008060
Resistor, Thin Film, 19R6, 0.1%, ±25ppm, 1/16W, 0603	MC008020	Resistor, Thin Film, 56R2, 0.1%, ±25ppm, 1/16W, 0603	MC008061
Resistor, Thin Film, 20R, 0.1%, ±25ppm, 1/16W, 0603	MC008021	Resistor, Thin Film, 57R6, 0.1%, ±25ppm, 1/16W, 0603	MC008062
Resistor, Thin Film, 20R5, 0.1%, ±25ppm, 1/16W, 0603	MC008022	Resistor, Thin Film, 59R, 0.1%, ±25ppm, 1/16W, 0603	MC008063
Resistor, Thin Film, 21R, 0.1%, ±25ppm, 1/16W, 0603	MC008023	Resistor, Thin Film, 60R4, 0.1%, ±25ppm, 1/16W, 0603	MC008064
Resistor, Thin Film, 21R5, 0.1%, ±25ppm, 1/16W, 0603	MC008024	Resistor, Thin Film, 61R9, 0.1%, ±25ppm, 1/16W, 0603	MC008065
Resistor, Thin Film, 22R1, 0.1%, ±25ppm, 1/16W, 0603	MC008025	Resistor, Thin Film, 63R4, 0.1%, ±25ppm, 1/16W, 0603	MC008066
Resistor, Thin Film, 22R6, 0.1%, ±25ppm, 1/16W, 0603	MC008026	Resistor, Thin Film, 64R9, 0.1%, ±25ppm, 1/16W, 0603	MC008067
Resistor, Thin Film, 23R2, 0.1%, ±25ppm, 1/16W, 0603	MC008027	Resistor, Thin Film, 66R5, 0.1%, ±25ppm, 1/16W, 0603	MC008068
Resistor, Thin Film, 23R7, 0.1%, ±25ppm, 1/16W, 0603	MC008028	Resistor, Thin Film, 68R1, 0.1%, ±25ppm, 1/16W, 0603	MC008069
Resistor, Thin Film, 24R3, 0.1%, ±25ppm, 1/16W, 0603	MC008029	Resistor, Thin Film, 69R8, 0.1%, ±25ppm, 1/16W, 0603	MC008070
Resistor, Thin Film, 24R9, 0.1%, ±25ppm, 1/16W, 0603	MC008030	Resistor, Thin Film, 71R5, 0.1%, ±25ppm, 1/16W, 0603	MC008071
Resistor, Thin Film, 25R5, 0.1%, ±25ppm, 1/16W, 0603	MC008031	Resistor, Thin Film, 73R2, 0.1%, ±25ppm, 1/16W, 0603	MC008072
Resistor, Thin Film, 26R1, 0.1%, ±25ppm, 1/16W, 0603	MC008032	Resistor, Thin Film, 75R, 0.1%, ±25ppm, 1/16W, 0603	MC008073
Resistor, Thin Film, 26R7, 0.1%, ±25ppm, 1/16W, 0603	MC008033	Resistor, Thin Film, 76R8, 0.1%, ±25ppm, 1/16W, 0603	MC008074
Resistor, Thin Film, 27R4, 0.1%, ±25ppm, 1/16W, 0603	MC008034	Resistor, Thin Film, 78R7, 0.1%, ±25ppm, 1/16W, 0603	MC008075
Resistor, Thin Film, 28R, 0.1%, ±25ppm, 1/16W, 0603	MC008035	Resistor, Thin Film, 80R6, 0.1%, ±25ppm, 1/16W, 0603	MC008076
Resistor, Thin Film, 29R4, 0.1%, ±25ppm, 1/16W, 0603	MC008036	Resistor, Thin Film, 82R5, 0.1%, ±25ppm, 1/16W, 0603	MC008077
Resistor, Thin Film, 31R6, 0.1%, ±25ppm, 1/16W, 0603	MC008037	Resistor, Thin Film, 84R5, 0.1%, ±25ppm, 1/16W, 0603	MC008078
Resistor, Thin Film, 32R4, 0.1%, ±25ppm, 1/16W, 0603	MC008038	Resistor, Thin Film, 86R6, 0.1%, ±25ppm, 1/16W, 0603	MC008079
Resistor, Thin Film, 33R2, 0.1%, ±25ppm, 1/16W, 0603	MC008039	Resistor, Thin Film, 88R7, 0.1%, ±25ppm, 1/16W, 0603	MC008080
Resistor, Thin Film, 34R, 0.1%, ±25ppm, 1/16W, 0603	MC008040	Resistor, Thin Film, 90R9, 0.1%, ±25ppm, 1/16W, 0603	MC008081
Resistor, Thin Film, 34R8, 0.1%, ±25ppm, 1/16W, 0603	MC008041	Resistor, Thin Film, 93R1, 0.1%, ±25ppm, 1/16W, 0603	MC008082
Resistor, Thin Film, 35R7, 0.1%, ±25ppm, 1/16W, 0603	MC008042	Resistor, Thin Film, 95R3, 0.1%, ±25ppm, 1/16W, 0603	MC008083
Resistor, Thin Film, 36R5, 0.1%, ±25ppm, 1/16W, 0603	MC008043	Resistor, Thin Film, 97R6, 0.1%, ±25ppm, 1/16W, 0603	MC008084
Resistor, Thin Film, 37R4, 0.1%, ±25ppm, 1/16W, 0603	MC008044	Resistor, Thin Film, 102R, 0.1%, ±25ppm, 1/16W, 0603	MC008086
Resistor, Thin Film, 38R3, 0.1%, ±25ppm, 1/16W, 0603	MC008045	Resistor, Thin Film, 105R, 0.1%, ±25ppm, 1/16W, 0603	MC008087
Resistor, Thin Film, 39R2, 0.1%, ±25ppm, 1/16W, 0603	MC008046	Resistor, Thin Film, 107R, 0.1%, ±25ppm, 1/16W, 0603	MC008088
Resistor, Thin Film, 40R2, 0.1%, ±25ppm, 1/16W, 0603	MC008047	Resistor, Thin Film, 110R, 0.1%, ±25ppm, 1/16W, 0603	MC008089
Resistor, Thin Film, 41R2, 0.1%, ±25ppm, 1/16W, 0603	MC008048	Resistor, Thin Film, 113R, 0.1%, ±25ppm, 1/16W, 0603	MC008090

Thin Film Precision Chip Resistor

Description	Part Number	Description	Part Number
Resistor, Thin Film, 887R, 0.1%, ±25ppm, 1/16W, 0603	MC008173	Resistor, Thin Film, 2K43, 0.1%, ±25ppm, 1/16W, 0603	MC008215
Resistor, Thin Film, 909R, 0.1%, ±25ppm, 1/16W, 0603	MC008174	Resistor, Thin Film, 2K49, 0.1%, ±25ppm, 1/16W, 0603	MC008216
Resistor, Thin Film, 931R, 0.1%, ±25ppm, 1/16W, 0603	MC008175	Resistor, Thin Film, 2K55, 0.1%, ±25ppm, 1/16W, 0603	MC008217
Resistor, Thin Film, 953R, 0.1%, ±25ppm, 1/16W, 0603	MC008176	Resistor, Thin Film, 2K61, 0.1%, ±25ppm, 1/16W, 0603	MC008218
Resistor, Thin Film, 976R, 0.1%, ±25ppm, 1/16W, 0603	MC008177	Resistor, Thin Film, 2K67, 0.1%, ±25ppm, 1/16W, 0603	MC008219
Resistor, Thin Film, 1K02, 0.1%, ±25ppm, 1/16W, 0603	MC008179	Resistor, Thin Film, 2K74, 0.1%, ±25ppm, 1/16W, 0603	MC008220
Resistor, Thin Film, 1K05, 0.1%, ±25ppm, 1/16W, 0603	MC008180	Resistor, Thin Film, 2K8, 0.1%, ±25ppm, 1/16W, 0603	MC008221
Resistor, Thin Film, 1K07, 0.1%, ±25ppm, 1/16W, 0603	MC008181	Resistor, Thin Film, 2K94, 0.1%, ±25ppm, 1/16W, 0603	MC008222
Resistor, Thin Film, 1K1, 0.1%, ±25ppm, 1/16W, 0603	MC008182	Resistor, Thin Film, 3K16, 0.1%, ±25ppm, 1/16W, 0603	MC008223
Resistor, Thin Film, 1K13, 0.1%, ±25ppm, 1/16W, 0603	MC008183	Resistor, Thin Film, 3K24, 0.1%, ±25ppm, 1/16W, 0603	MC008224
Resistor, Thin Film, 1K15, 0.1%, ±25ppm, 1/16W, 0603	MC008184	Resistor, Thin Film, 3K32, 0.1%, ±25ppm, 1/16W, 0603	MC008225
Resistor, Thin Film, 1K18, 0.1%, ±25ppm, 1/16W, 0603	MC008185	Resistor, Thin Film, 3K4, 0.1%, ±25ppm, 1/16W, 0603	MC008226
Resistor, Thin Film, 1K21, 0.1%, ±25ppm, 1/16W, 0603	MC008186	Resistor, Thin Film, 3K48, 0.1%, ±25ppm, 1/16W, 0603	MC008227
Resistor, Thin Film, 1K24, 0.1%, ±25ppm, 1/16W, 0603	MC008187	Resistor, Thin Film, 3K57, 0.1%, ±25ppm, 1/16W, 0603	MC008228
Resistor, Thin Film, 1K27, 0.1%, ±25ppm, 1/16W, 0603	MC008188	Resistor, Thin Film, 3K65, 0.1%, ±25ppm, 1/16W, 0603	MC008229
Resistor, Thin Film, 1K3, 0.1%, ±25ppm, 1/16W, 0603	MC008189	Resistor, Thin Film, 3K74, 0.1%, ±25ppm, 1/16W, 0603	MC008230
Resistor, Thin Film, 1K33, 0.1%, ±25ppm, 1/16W, 0603	MC008190	Resistor, Thin Film, 3K83, 0.1%, ±25ppm, 1/16W, 0603	MC008231
Resistor, Thin Film, 1K37, 0.1%, ±25ppm, 1/16W, 0603	MC008191	Resistor, Thin Film, 3K92, 0.1%, ±25ppm, 1/16W, 0603	MC008232
Resistor, Thin Film, 1K4, 0.1%, ±25ppm, 1/16W, 0603	MC008192	Resistor, Thin Film, 4K02, 0.1%, ±25ppm, 1/16W, 0603	MC008233
Resistor, Thin Film, 1K43, 0.1%, ±25ppm, 1/16W, 0603	MC008193	Resistor, Thin Film, 4K12, 0.1%, ±25ppm, 1/16W, 0603	MC008234
Resistor, Thin Film, 1K47, 0.1%, ±25ppm, 1/16W, 0603	MC008194	Resistor, Thin Film, 4K22, 0.1%, ±25ppm, 1/16W, 0603	MC008235
Resistor, Thin Film, 1K5, 0.1%, ±25ppm, 1/16W, 0603	MC008195	Resistor, Thin Film, 4K32, 0.1%, ±25ppm, 1/16W, 0603	MC008236
Resistor, Thin Film, 1K54, 0.1%, ±25ppm, 1/16W, 0603	MC008196	Resistor, Thin Film, 4K42, 0.1%, ±25ppm, 1/16W, 0603	MC008237
Resistor, Thin Film, 1K58, 0.1%, ±25ppm, 1/16W, 0603	MC008197	Resistor, Thin Film, 4K53, 0.1%, ±25ppm, 1/16W, 0603	MC008238
Resistor, Thin Film, 1K62, 0.1%, ±25ppm, 1/16W, 0603	MC008198	Resistor, Thin Film, 4K64, 0.1%, ±25ppm, 1/16W, 0603	MC008239
Resistor, Thin Film, 1K65, 0.1%, ±25ppm, 1/16W, 0603	MC008199	Resistor, Thin Film, 4K75, 0.1%, ±25ppm, 1/16W, 0603	MC008240
Resistor, Thin Film, 1K69, 0.1%, ±25ppm, 1/16W, 0603	MC008200	Resistor, Thin Film, 4K87, 0.1%, ±25ppm, 1/16W, 0603	MC008241
Resistor, Thin Film, 1K74, 0.1%, ±25ppm, 1/16W, 0603	MC008201	Resistor, Thin Film, 4K99, 0.1%, ±25ppm, 1/16W, 0603	MC008242
Resistor, Thin Film, 1K78, 0.1%, ±25ppm, 1/16W, 0603	MC008202	Resistor, Thin Film, 5K11, 0.1%, ±25ppm, 1/16W, 0603	MC008243
Resistor, Thin Film, 1K82, 0.1%, ±25ppm, 1/16W, 0603	MC008203	Resistor, Thin Film, 5K23, 0.1%, ±25ppm, 1/16W, 0603	MC008244
Resistor, Thin Film, 1K87, 0.1%, ±25ppm, 1/16W, 0603	MC008204	Resistor, Thin Film, 5K36, 0.1%, ±25ppm, 1/16W, 0603	MC008245
Resistor, Thin Film, 1K91, 0.1%, ±25ppm, 1/16W, 0603	MC008205	Resistor, Thin Film, 5K49, 0.1%, ±25ppm, 1/16W, 0603	MC008246
Resistor, Thin Film, 1K96, 0.1%, ±25ppm, 1/16W, 0603	MC008206	Resistor, Thin Film, 5K62, 0.1%, ±25ppm, 1/16W, 0603	MC008247
Resistor, Thin Film, 2K, 0.1%, ±25ppm, 1/16W, 0603	MC008207	Resistor, Thin Film, 5K76, 0.1%, ±25ppm, 1/16W, 0603	MC008248
Resistor, Thin Film, 2K05, 0.1%, ±25ppm, 1/16W, 0603	MC008208	Resistor, Thin Film, 5K9, 0.1%, ±25ppm, 1/16W, 0603	MC008249
Resistor, Thin Film, 2K1, 0.1%, ±25ppm, 1/16W, 0603	MC008209	Resistor, Thin Film, 6K04, 0.1%, ±25ppm, 1/16W, 0603	MC008250
Resistor, Thin Film, 2K15, 0.1%, ±25ppm, 1/16W, 0603	MC008210	Resistor, Thin Film, 6K19, 0.1%, ±25ppm, 1/16W, 0603	MC008251
Resistor, Thin Film, 2K21, 0.1%, ±25ppm, 1/16W, 0603	MC008211	Resistor, Thin Film, 6K34, 0.1%, ±25ppm, 1/16W, 0603	MC008252
Resistor, Thin Film, 2K26, 0.1%, ±25ppm, 1/16W, 0603	MC008212	Resistor, Thin Film, 6K49, 0.1%, ±25ppm, 1/16W, 0603	MC008253
Resistor, Thin Film, 2K32, 0.1%, ±25ppm, 1/16W, 0603	MC008213	Resistor, Thin Film, 6K65, 0.1%, ±25ppm, 1/16W, 0603	MC008254
Resistor, Thin Film, 2K37, 0.1%, ±25ppm, 1/16W, 0603	MC008214	Resistor, Thin Film, 6K81, 0.1%, ±25ppm, 1/16W, 0603	MC008255

www.element14.com
www.farnell.com
www.newark.com



Thin Film Precision Chip Resistor

Description	Part Number	Description	Part Number
Resistor, Thin Film, 6K98, 0.1%, ±25ppm, 1/16W, 0603	MC008256	Resistor, Thin Film, 19K6, 0.1%, ±25ppm, 1/16W, 0603	MC008299
Resistor, Thin Film, 7K15, 0.1%, ±25ppm, 1/16W, 0603	MC008257	Resistor, Thin Film, 20K, 0.1%, ±25ppm, 1/16W, 0603	MC008300
Resistor, Thin Film, 7K32, 0.1%, ±25ppm, 1/16W, 0603	MC008258	Resistor, Thin Film, 20K5, 0.1%, ±25ppm, 1/16W, 0603	MC008301
Resistor, Thin Film, 7K5, 0.1%, ±25ppm, 1/16W, 0603	MC008259	Resistor, Thin Film, 21K, 0.1%, ±25ppm, 1/16W, 0603	MC008302
Resistor, Thin Film, 7K68, 0.1%, ±25ppm, 1/16W, 0603	MC008260	Resistor, Thin Film, 21K5, 0.1%, ±25ppm, 1/16W, 0603	MC008303
Resistor, Thin Film, 7K87, 0.1%, ±25ppm, 1/16W, 0603	MC008261	Resistor, Thin Film, 22K1, 0.1%, ±25ppm, 1/16W, 0603	MC008304
Resistor, Thin Film, 8K06, 0.1%, ±25ppm, 1/16W, 0603	MC008262	Resistor, Thin Film, 22K6, 0.1%, ±25ppm, 1/16W, 0603	MC008305
Resistor, Thin Film, 8K25, 0.1%, ±25ppm, 1/16W, 0603	MC008263	Resistor, Thin Film, 23K2, 0.1%, ±25ppm, 1/16W, 0603	MC008306
Resistor, Thin Film, 8K45, 0.1%, ±25ppm, 1/16W, 0603	MC008264	Resistor, Thin Film, 23K7, 0.1%, ±25ppm, 1/16W, 0603	MC008307
Resistor, Thin Film, 8K66, 0.1%, ±25ppm, 1/16W, 0603	MC008265	Resistor, Thin Film, 24K3, 0.1%, ±25ppm, 1/16W, 0603	MC008308
Resistor, Thin Film, 8K87, 0.1%, ±25ppm, 1/16W, 0603	MC008266	Resistor, Thin Film, 24K9, 0.1%, ±25ppm, 1/16W, 0603	MC008309
Resistor, Thin Film, 9K09, 0.1%, ±25ppm, 1/16W, 0603	MC008267	Resistor, Thin Film, 25K5, 0.1%, ±25ppm, 1/16W, 0603	MC008310
Resistor, Thin Film, 9K31, 0.1%, ±25ppm, 1/16W, 0603	MC008268	Resistor, Thin Film, 26K1, 0.1%, ±25ppm, 1/16W, 0603	MC008311
Resistor, Thin Film, 9K53, 0.1%, ±25ppm, 1/16W, 0603	MC008269	Resistor, Thin Film, 26K7, 0.1%, ±25ppm, 1/16W, 0603	MC008312
Resistor, Thin Film, 9K76, 0.1%, ±25ppm, 1/16W, 0603	MC008270	Resistor, Thin Film, 27K4, 0.1%, ±25ppm, 1/16W, 0603	MC008313
Resistor, Thin Film, 10K2, 0.1%, ±25ppm, 1/16W, 0603	MC008272	Resistor, Thin Film, 28K, 0.1%, ±25ppm, 1/16W, 0603	MC008314
Resistor, Thin Film, 10K5, 0.1%, ±25ppm, 1/16W, 0603	MC008273	Resistor, Thin Film, 29K4, 0.1%, ±25ppm, 1/16W, 0603	MC008315
Resistor, Thin Film, 10K7, 0.1%, ±25ppm, 1/16W, 0603	MC008274	Resistor, Thin Film, 31K6, 0.1%, ±25ppm, 1/16W, 0603	MC008316
Resistor, Thin Film, 11K, 0.1%, ±25ppm, 1/16W, 0603	MC008275	Resistor, Thin Film, 32K4, 0.1%, ±25ppm, 1/16W, 0603	MC008317
Resistor, Thin Film, 11K3, 0.1%, ±25ppm, 1/16W, 0603	MC008276	Resistor, Thin Film, 33K2, 0.1%, ±25ppm, 1/16W, 0603	MC008318
Resistor, Thin Film, 11K5, 0.1%, ±25ppm, 1/16W, 0603	MC008277	Resistor, Thin Film, 34K, 0.1%, ±25ppm, 1/16W, 0603	MC008319
Resistor, Thin Film, 11K8, 0.1%, ±25ppm, 1/16W, 0603	MC008278	Resistor, Thin Film, 34K8, 0.1%, ±25ppm, 1/16W, 0603	MC008320
Resistor, Thin Film, 12K1, 0.1%, ±25ppm, 1/16W, 0603	MC008279	Resistor, Thin Film, 35K7, 0.1%, ±25ppm, 1/16W, 0603	MC008321
Resistor, Thin Film, 12K4, 0.1%, ±25ppm, 1/16W, 0603	MC008280	Resistor, Thin Film, 36K5, 0.1%, ±25ppm, 1/16W, 0603	MC008322
Resistor, Thin Film, 12K7, 0.1%, ±25ppm, 1/16W, 0603	MC008281	Resistor, Thin Film, 37K4, 0.1%, ±25ppm, 1/16W, 0603	MC008323
Resistor, Thin Film, 13K, 0.1%, ±25ppm, 1/16W, 0603	MC008282	Resistor, Thin Film, 38K3, 0.1%, ±25ppm, 1/16W, 0603	MC008324
Resistor, Thin Film, 13K3, 0.1%, ±25ppm, 1/16W, 0603	MC008283	Resistor, Thin Film, 39K2, 0.1%, ±25ppm, 1/16W, 0603	MC008325
Resistor, Thin Film, 13K7, 0.1%, ±25ppm, 1/16W, 0603	MC008284	Resistor, Thin Film, 40K2, 0.1%, ±25ppm, 1/16W, 0603	MC008326
Resistor, Thin Film, 14K, 0.1%, ±25ppm, 1/16W, 0603	MC008285	Resistor, Thin Film, 41K2, 0.1%, ±25ppm, 1/16W, 0603	MC008327
Resistor, Thin Film, 14K3, 0.1%, ±25ppm, 1/16W, 0603	MC008286	Resistor, Thin Film, 42K2, 0.1%, ±25ppm, 1/16W, 0603	MC008328
Resistor, Thin Film, 14K7, 0.1%, ±25ppm, 1/16W, 0603	MC008287	Resistor, Thin Film, 43K2, 0.1%, ±25ppm, 1/16W, 0603	MC008329
Resistor, Thin Film, 15K4, 0.1%, ±25ppm, 1/16W, 0603	MC008289	Resistor, Thin Film, 44K2, 0.1%, ±25ppm, 1/16W, 0603	MC008330
Resistor, Thin Film, 15K8, 0.1%, ±25ppm, 1/16W, 0603	MC008290	Resistor, Thin Film, 45K3, 0.1%, ±25ppm, 1/16W, 0603	MC008331
Resistor, Thin Film, 16K2, 0.1%, ±25ppm, 1/16W, 0603	MC008291	Resistor, Thin Film, 46K4, 0.1%, ±25ppm, 1/16W, 0603	MC008332
Resistor, Thin Film, 16K5, 0.1%, ±25ppm, 1/16W, 0603	MC008292	Resistor, Thin Film, 47K5, 0.1%, ±25ppm, 1/16W, 0603	MC008333
Resistor, Thin Film, 16K9, 0.1%, ±25ppm, 1/16W, 0603	MC008293	Resistor, Thin Film, 48K7, 0.1%, ±25ppm, 1/16W, 0603	MC008334
Resistor, Thin Film, 17K4, 0.1%, ±25ppm, 1/16W, 0603	MC008294	Resistor, Thin Film, 49K9, 0.1%, ±25ppm, 1/16W, 0603	MC008335
Resistor, Thin Film, 17K8, 0.1%, ±25ppm, 1/16W, 0603	MC008295	Resistor, Thin Film, 51K1, 0.1%, ±25ppm, 1/16W, 0603	MC008336
Resistor, Thin Film, 18K2, 0.1%, ±25ppm, 1/16W, 0603	MC008296	Resistor, Thin Film, 52K3, 0.1%, ±25ppm, 1/16W, 0603	MC008337
Resistor, Thin Film, 18K7, 0.1%, ±25ppm, 1/16W, 0603	MC008297	Resistor, Thin Film, 53K6, 0.1%, ±25ppm, 1/16W, 0603	MC008338
Resistor, Thin Film, 19K1, 0.1%, ±25ppm, 1/16W, 0603	MC008298	Resistor, Thin Film, 54K9, 0.1%, ±25ppm, 1/16W, 0603	MC008339

Thin Film Precision Chip Resistor

Description	Part Number	Description	Part Number
Resistor, Thin Film, 442K, 0.1%, ±25ppm, 1/16W, 0603	MC008423	Resistor, Thin Film, 8R2, 0.1%, ±25ppm, 1/10W, 0805	MC008464
Resistor, Thin Film, 453K, 0.1%, ±25ppm, 1/16W, 0603	MC008424	Resistor, Thin Film, 9R1, 0.1%, ±25ppm, 1/10W, 0805	MC008465
Resistor, Thin Film, 464K, 0.1%, ±25ppm, 1/16W, 0603	MC008425	Resistor, Thin Film, 10R, 0.1%, ±25ppm, 1/10W, 0805	MC008466
Resistor, Thin Film, 475K, 0.1%, ±25ppm, 1/16W, 0603	MC008426	Resistor, Thin Film, 10R2, 0.1%, ±25ppm, 1/10W, 0805	MC008467
Resistor, Thin Film, 487K, 0.1%, ±25ppm, 1/16W, 0603	MC008427	Resistor, Thin Film, 10R5, 0.1%, ±25ppm, 1/10W, 0805	MC008468
Resistor, Thin Film, 499K, 0.1%, ±25ppm, 1/16W, 0603	MC008428	Resistor, Thin Film, 10R7, 0.1%, ±25ppm, 1/10W, 0805	MC008469
Resistor, Thin Film, 511K, 0.1%, ±25ppm, 1/16W, 0603	MC008429	Resistor, Thin Film, 11R, 0.1%, ±25ppm, 1/10W, 0805	MC008470
Resistor, Thin Film, 523K, 0.1%, ±25ppm, 1/16W, 0603	MC008430	Resistor, Thin Film, 11R3, 0.1%, ±25ppm, 1/10W, 0805	MC008471
Resistor, Thin Film, 536K, 0.1%, ±25ppm, 1/16W, 0603	MC008431	Resistor, Thin Film, 11R5, 0.1%, ±25ppm, 1/10W, 0805	MC008472
Resistor, Thin Film, 549K, 0.1%, ±25ppm, 1/16W, 0603	MC008432	Resistor, Thin Film, 11R8, 0.1%, ±25ppm, 1/10W, 0805	MC008473
Resistor, Thin Film, 562K, 0.1%, ±25ppm, 1/16W, 0603	MC008433	Resistor, Thin Film, 12R1, 0.1%, ±25ppm, 1/10W, 0805	MC008474
Resistor, Thin Film, 576K, 0.1%, ±25ppm, 1/16W, 0603	MC008434	Resistor, Thin Film, 12R4, 0.1%, ±25ppm, 1/10W, 0805	MC008475
Resistor, Thin Film, 590K, 0.1%, ±25ppm, 1/16W, 0603	MC008435	Resistor, Thin Film, 12R7, 0.1%, ±25ppm, 1/10W, 0805	MC008476
Resistor, Thin Film, 604K, 0.1%, ±25ppm, 1/16W, 0603	MC008436	Resistor, Thin Film, 13R, 0.1%, ±25ppm, 1/10W, 0805	MC008477
Resistor, Thin Film, 619K, 0.1%, ±25ppm, 1/16W, 0603	MC008437	Resistor, Thin Film, 13R3, 0.1%, ±25ppm, 1/10W, 0805	MC008478
Resistor, Thin Film, 634K, 0.1%, ±25ppm, 1/16W, 0603	MC008438	Resistor, Thin Film, 13R7, 0.1%, ±25ppm, 1/10W, 0805	MC008479
Resistor, Thin Film, 649K, 0.1%, ±25ppm, 1/16W, 0603	MC008439	Resistor, Thin Film, 14R, 0.1%, ±25ppm, 1/10W, 0805	MC008480
Resistor, Thin Film, 665K, 0.1%, ±25ppm, 1/16W, 0603	MC008440	Resistor, Thin Film, 14R3, 0.1%, ±25ppm, 1/10W, 0805	MC008481
Resistor, Thin Film, 681K, 0.1%, ±25ppm, 1/16W, 0603	MC008441	Resistor, Thin Film, 14R7, 0.1%, ±25ppm, 1/10W, 0805	MC008482
Resistor, Thin Film, 698K, 0.1%, ±25ppm, 1/16W, 0603	MC008442	Resistor, Thin Film, 15R, 0.1%, ±25ppm, 1/10W, 0805	MC008483
Resistor, Thin Film, 715K, 0.1%, ±25ppm, 1/16W, 0603	MC008443	Resistor, Thin Film, 15R4, 0.1%, ±25ppm, 1/10W, 0805	MC008484
Resistor, Thin Film, 732K, 0.1%, ±25ppm, 1/16W, 0603	MC008444	Resistor, Thin Film, 15R8, 0.1%, ±25ppm, 1/10W, 0805	MC008485
Resistor, Thin Film, 750K, 0.1%, ±25ppm, 1/16W, 0603	MC008445	Resistor, Thin Film, 16R2, 0.1%, ±25ppm, 1/10W, 0805	MC008486
Resistor, Thin Film, 768K, 0.1%, ±25ppm, 1/16W, 0603	MC008446	Resistor, Thin Film, 16R5, 0.1%, ±25ppm, 1/10W, 0805	MC008487
Resistor, Thin Film, 787K, 0.1%, ±25ppm, 1/16W, 0603	MC008447	Resistor, Thin Film, 16R9, 0.1%, ±25ppm, 1/10W, 0805	MC008488
Resistor, Thin Film, 806K, 0.1%, ±25ppm, 1/16W, 0603	MC008448	Resistor, Thin Film, 17R4, 0.1%, ±25ppm, 1/10W, 0805	MC008489
Resistor, Thin Film, 825K, 0.1%, ±25ppm, 1/16W, 0603	MC008449	Resistor, Thin Film, 17R8, 0.1%, ±25ppm, 1/10W, 0805	MC008490
Resistor, Thin Film, 845K, 0.1%, ±25ppm, 1/16W, 0603	MC008450	Resistor, Thin Film, 18R2, 0.1%, ±25ppm, 1/10W, 0805	MC008491
Resistor, Thin Film, 866K, 0.1%, ±25ppm, 1/16W, 0603	MC008451	Resistor, Thin Film, 18R7, 0.1%, ±25ppm, 1/10W, 0805	MC008492
Resistor, Thin Film, 887K, 0.1%, ±25ppm, 1/16W, 0603	MC008452	Resistor, Thin Film, 19R1, 0.1%, ±25ppm, 1/10W, 0805	MC008493
Resistor, Thin Film, 909K, 0.1%, ±25ppm, 1/16W, 0603	MC008453	Resistor, Thin Film, 19R6, 0.1%, ±25ppm, 1/10W, 0805	MC008494
Resistor, Thin Film, 931K, 0.1%, ±25ppm, 1/16W, 0603	MC008454	Resistor, Thin Film, 20R, 0.1%, ±25ppm, 1/10W, 0805	MC008495
Resistor, Thin Film, 953K, 0.1%, ±25ppm, 1/16W, 0603	MC008455	Resistor, Thin Film, 20R5, 0.1%, ±25ppm, 1/10W, 0805	MC008496
Resistor, Thin Film, 976K, 0.1%, ±25ppm, 1/16W, 0603	MC008456	Resistor, Thin Film, 21R, 0.1%, ±25ppm, 1/10W, 0805	MC008497
Resistor, Thin Film, 1M, 0.1%, ±25ppm, 1/16W, 0603	MC008457	Resistor, Thin Film, 21R5, 0.1%, ±25ppm, 1/10W, 0805	MC008498
Resistor, Thin Film, 4R7, 0.1%, ±25ppm, 1/10W, 0805	MC008458	Resistor, Thin Film, 22R1, 0.1%, ±25ppm, 1/10W, 0805	MC008499
Resistor, Thin Film, 5R1, 0.1%, ±25ppm, 1/10W, 0805	MC008459	Resistor, Thin Film, 22R6, 0.1%, ±25ppm, 1/10W, 0805	MC008500
Resistor, Thin Film, 5R6, 0.1%, ±25ppm, 1/10W, 0805	MC008460	Resistor, Thin Film, 23R2, 0.1%, ±25ppm, 1/10W, 0805	MC008501
Resistor, Thin Film, 6R2, 0.1%, ±25ppm, 1/10W, 0805	MC008461	Resistor, Thin Film, 23R7, 0.1%, ±25ppm, 1/10W, 0805	MC008502
Resistor, Thin Film, 6R8, 0.1%, ±25ppm, 1/10W, 0805	MC008462	Resistor, Thin Film, 24R3, 0.1%, ±25ppm, 1/10W, 0805	MC008503
Resistor, Thin Film, 7R5, 0.1%, ±25ppm, 1/10W, 0805	MC008463	Resistor, Thin Film, 24R9, 0.1%, ±25ppm, 1/10W, 0805	MC008504

www.element14.com
www.farnell.com
www.newark.com



Thin Film Precision Chip Resistor

Description	Part Number	Description	Part Number
Resistor, Thin Film, 25R5, 0.1%, ±25ppm, 1/10W, 0805	MC008505	Resistor, Thin Film, 73R2, 0.1%, ±25ppm, 1/10W, 0805	MC008546
Resistor, Thin Film, 26R1, 0.1%, ±25ppm, 1/10W, 0805	MC008506	Resistor, Thin Film, 75R, 0.1%, ±25ppm, 1/10W, 0805	MC008547
Resistor, Thin Film, 26R7, 0.1%, ±25ppm, 1/10W, 0805	MC008507	Resistor, Thin Film, 76R8, 0.1%, ±25ppm, 1/10W, 0805	MC008548
Resistor, Thin Film, 27R4, 0.1%, ±25ppm, 1/10W, 0805	MC008508	Resistor, Thin Film, 78R7, 0.1%, ±25ppm, 1/10W, 0805	MC008549
Resistor, Thin Film, 28R, 0.1%, ±25ppm, 1/10W, 0805	MC008509	Resistor, Thin Film, 80R6, 0.1%, ±25ppm, 1/10W, 0805	MC008550
Resistor, Thin Film, 29R4, 0.1%, ±25ppm, 1/10W, 0805	MC008510	Resistor, Thin Film, 82R5, 0.1%, ±25ppm, 1/10W, 0805	MC008551
Resistor, Thin Film, 31R6, 0.1%, ±25ppm, 1/10W, 0805	MC008511	Resistor, Thin Film, 84R5, 0.1%, ±25ppm, 1/10W, 0805	MC008552
Resistor, Thin Film, 32R4, 0.1%, ±25ppm, 1/10W, 0805	MC008512	Resistor, Thin Film, 86R6, 0.1%, ±25ppm, 1/10W, 0805	MC008553
Resistor, Thin Film, 33R2, 0.1%, ±25ppm, 1/10W, 0805	MC008513	Resistor, Thin Film, 88R7, 0.1%, ±25ppm, 1/10W, 0805	MC008554
Resistor, Thin Film, 34R, 0.1%, ±25ppm, 1/10W, 0805	MC008514	Resistor, Thin Film, 90R9, 0.1%, ±25ppm, 1/10W, 0805	MC008555
Resistor, Thin Film, 34R8, 0.1%, ±25ppm, 1/10W, 0805	MC008515	Resistor, Thin Film, 93R1, 0.1%, ±25ppm, 1/10W, 0805	MC008556
Resistor, Thin Film, 35R7, 0.1%, ±25ppm, 1/10W, 0805	MC008516	Resistor, Thin Film, 95R3, 0.1%, ±25ppm, 1/10W, 0805	MC008557
Resistor, Thin Film, 36R5, 0.1%, ±25ppm, 1/10W, 0805	MC008517	Resistor, Thin Film, 97R6, 0.1%, ±25ppm, 1/10W, 0805	MC008558
Resistor, Thin Film, 37R4, 0.1%, ±25ppm, 1/10W, 0805	MC008518	Resistor, Thin Film, 102R, 0.1%, ±25ppm, 1/10W, 0805	MC008560
Resistor, Thin Film, 38R3, 0.1%, ±25ppm, 1/10W, 0805	MC008519	Resistor, Thin Film, 105R, 0.1%, ±25ppm, 1/10W, 0805	MC008561
Resistor, Thin Film, 39R2, 0.1%, ±25ppm, 1/10W, 0805	MC008520	Resistor, Thin Film, 107R, 0.1%, ±25ppm, 1/10W, 0805	MC008562
Resistor, Thin Film, 40R2, 0.1%, ±25ppm, 1/10W, 0805	MC008521	Resistor, Thin Film, 110R, 0.1%, ±25ppm, 1/10W, 0805	MC008563
Resistor, Thin Film, 41R2, 0.1%, ±25ppm, 1/10W, 0805	MC008522	Resistor, Thin Film, 113R, 0.1%, ±25ppm, 1/10W, 0805	MC008564
Resistor, Thin Film, 42R2, 0.1%, ±25ppm, 1/10W, 0805	MC008523	Resistor, Thin Film, 115R, 0.1%, ±25ppm, 1/10W, 0805	MC008565
Resistor, Thin Film, 43R2, 0.1%, ±25ppm, 1/10W, 0805	MC008524	Resistor, Thin Film, 118R, 0.1%, ±25ppm, 1/10W, 0805	MC008566
Resistor, Thin Film, 44R2, 0.1%, ±25ppm, 1/10W, 0805	MC008525	Resistor, Thin Film, 121R, 0.1%, ±25ppm, 1/10W, 0805	MC008567
Resistor, Thin Film, 45R3, 0.1%, ±25ppm, 1/10W, 0805	MC008526	Resistor, Thin Film, 124R, 0.1%, ±25ppm, 1/10W, 0805	MC008568
Resistor, Thin Film, 46R4, 0.1%, ±25ppm, 1/10W, 0805	MC008527	Resistor, Thin Film, 127R, 0.1%, ±25ppm, 1/10W, 0805	MC008569
Resistor, Thin Film, 47R5, 0.1%, ±25ppm, 1/10W, 0805	MC008528	Resistor, Thin Film, 130R, 0.1%, ±25ppm, 1/10W, 0805	MC008570
Resistor, Thin Film, 48R7, 0.1%, ±25ppm, 1/10W, 0805	MC008529	Resistor, Thin Film, 133R, 0.1%, ±25ppm, 1/10W, 0805	MC008571
Resistor, Thin Film, 49R9, 0.1%, ±25ppm, 1/10W, 0805	MC008530	Resistor, Thin Film, 137R, 0.1%, ±25ppm, 1/10W, 0805	MC008572
Resistor, Thin Film, 51R1, 0.1%, ±25ppm, 1/10W, 0805	MC008531	Resistor, Thin Film, 140R, 0.1%, ±25ppm, 1/10W, 0805	MC008573
Resistor, Thin Film, 52R3, 0.1%, ±25ppm, 1/10W, 0805	MC008532	Resistor, Thin Film, 143R, 0.1%, ±25ppm, 1/10W, 0805	MC008574
Resistor, Thin Film, 53R6, 0.1%, ±25ppm, 1/10W, 0805	MC008533	Resistor, Thin Film, 147R, 0.1%, ±25ppm, 1/10W, 0805	MC008575
Resistor, Thin Film, 54R9, 0.1%, ±25ppm, 1/10W, 0805	MC008534	Resistor, Thin Film, 150R, 0.1%, ±25ppm, 1/10W, 0805	MC008576
Resistor, Thin Film, 56R2, 0.1%, ±25ppm, 1/10W, 0805	MC008535	Resistor, Thin Film, 154R, 0.1%, ±25ppm, 1/10W, 0805	MC008577
Resistor, Thin Film, 57R6, 0.1%, ±25ppm, 1/10W, 0805	MC008536	Resistor, Thin Film, 158R, 0.1%, ±25ppm, 1/10W, 0805	MC008578
Resistor, Thin Film, 59R, 0.1%, ±25ppm, 1/10W, 0805	MC008537	Resistor, Thin Film, 162R, 0.1%, ±25ppm, 1/10W, 0805	MC008579
Resistor, Thin Film, 60R4, 0.1%, ±25ppm, 1/10W, 0805	MC008538	Resistor, Thin Film, 165R, 0.1%, ±25ppm, 1/10W, 0805	MC008580
Resistor, Thin Film, 61R9, 0.1%, ±25ppm, 1/10W, 0805	MC008539	Resistor, Thin Film, 169R, 0.1%, ±25ppm, 1/10W, 0805	MC008581
Resistor, Thin Film, 63R4, 0.1%, ±25ppm, 1/10W, 0805	MC008540	Resistor, Thin Film, 174R, 0.1%, ±25ppm, 1/10W, 0805	MC008582
Resistor, Thin Film, 64R9, 0.1%, ±25ppm, 1/10W, 0805	MC008541	Resistor, Thin Film, 178R, 0.1%, ±25ppm, 1/10W, 0805	MC008583
Resistor, Thin Film, 66R5, 0.1%, ±25ppm, 1/10W, 0805	MC008542	Resistor, Thin Film, 182R, 0.1%, ±25ppm, 1/10W, 0805	MC008584
Resistor, Thin Film, 68R1, 0.1%, ±25ppm, 1/10W, 0805	MC008543	Resistor, Thin Film, 187R, 0.1%, ±25ppm, 1/10W, 0805	MC008585
Resistor, Thin Film, 69R8, 0.1%, ±25ppm, 1/10W, 0805	MC008544	Resistor, Thin Film, 191R, 0.1%, ±25ppm, 1/10W, 0805	MC008586
Resistor, Thin Film, 71R5, 0.1%, ±25ppm, 1/10W, 0805	MC008545	Resistor, Thin Film, 196R, 0.1%, ±25ppm, 1/10W, 0805	MC008587

www.element14.com
www.farnell.com
www.newark.com



Thin Film Precision Chip Resistor

Description	Part Number	Description	Part Number
Resistor, Thin Film, 200R, 0.1%, ±25ppm, 1/10W, 0805	MC008588	Resistor, Thin Film, 576R, 0.1%, ±25ppm, 1/10W, 0805	MC008629
Resistor, Thin Film, 205R, 0.1%, ±25ppm, 1/10W, 0805	MC008589	Resistor, Thin Film, 590R, 0.1%, ±25ppm, 1/10W, 0805	MC008630
Resistor, Thin Film, 210R, 0.1%, ±25ppm, 1/10W, 0805	MC008590	Resistor, Thin Film, 604R, 0.1%, ±25ppm, 1/10W, 0805	MC008631
Resistor, Thin Film, 215R, 0.1%, ±25ppm, 1/10W, 0805	MC008591	Resistor, Thin Film, 619R, 0.1%, ±25ppm, 1/10W, 0805	MC008632
Resistor, Thin Film, 221R, 0.1%, ±25ppm, 1/10W, 0805	MC008592	Resistor, Thin Film, 634R, 0.1%, ±25ppm, 1/10W, 0805	MC008633
Resistor, Thin Film, 226R, 0.1%, ±25ppm, 1/10W, 0805	MC008593	Resistor, Thin Film, 649R, 0.1%, ±25ppm, 1/10W, 0805	MC008634
Resistor, Thin Film, 232R, 0.1%, ±25ppm, 1/10W, 0805	MC008594	Resistor, Thin Film, 665R, 0.1%, ±25ppm, 1/10W, 0805	MC008635
Resistor, Thin Film, 237R, 0.1%, ±25ppm, 1/10W, 0805	MC008595	Resistor, Thin Film, 681R, 0.1%, ±25ppm, 1/10W, 0805	MC008636
Resistor, Thin Film, 243R, 0.1%, ±25ppm, 1/10W, 0805	MC008596	Resistor, Thin Film, 698R, 0.1%, ±25ppm, 1/10W, 0805	MC008637
Resistor, Thin Film, 249R, 0.1%, ±25ppm, 1/10W, 0805	MC008597	Resistor, Thin Film, 715R, 0.1%, ±25ppm, 1/10W, 0805	MC008638
Resistor, Thin Film, 255R, 0.1%, ±25ppm, 1/10W, 0805	MC008598	Resistor, Thin Film, 732R, 0.1%, ±25ppm, 1/10W, 0805	MC008639
Resistor, Thin Film, 261R, 0.1%, ±25ppm, 1/10W, 0805	MC008599	Resistor, Thin Film, 750R, 0.1%, ±25ppm, 1/10W, 0805	MC008640
Resistor, Thin Film, 267R, 0.1%, ±25ppm, 1/10W, 0805	MC008600	Resistor, Thin Film, 768R, 0.1%, ±25ppm, 1/10W, 0805	MC008641
Resistor, Thin Film, 274R, 0.1%, ±25ppm, 1/10W, 0805	MC008601	Resistor, Thin Film, 787R, 0.1%, ±25ppm, 1/10W, 0805	MC008642
Resistor, Thin Film, 280R, 0.1%, ±25ppm, 1/10W, 0805	MC008602	Resistor, Thin Film, 806R, 0.1%, ±25ppm, 1/10W, 0805	MC008643
Resistor, Thin Film, 294R, 0.1%, ±25ppm, 1/10W, 0805	MC008603	Resistor, Thin Film, 825R, 0.1%, ±25ppm, 1/10W, 0805	MC008644
Resistor, Thin Film, 316R, 0.1%, ±25ppm, 1/10W, 0805	MC008604	Resistor, Thin Film, 845R, 0.1%, ±25ppm, 1/10W, 0805	MC008645
Resistor, Thin Film, 324R, 0.1%, ±25ppm, 1/10W, 0805	MC008605	Resistor, Thin Film, 866R, 0.1%, ±25ppm, 1/10W, 0805	MC008646
Resistor, Thin Film, 332R, 0.1%, ±25ppm, 1/10W, 0805	MC008606	Resistor, Thin Film, 887R, 0.1%, ±25ppm, 1/10W, 0805	MC008647
Resistor, Thin Film, 340R, 0.1%, ±25ppm, 1/10W, 0805	MC008607	Resistor, Thin Film, 909R, 0.1%, ±25ppm, 1/10W, 0805	MC008648
Resistor, Thin Film, 348R, 0.1%, ±25ppm, 1/10W, 0805	MC008608	Resistor, Thin Film, 931R, 0.1%, ±25ppm, 1/10W, 0805	MC008649
Resistor, Thin Film, 357R, 0.1%, ±25ppm, 1/10W, 0805	MC008609	Resistor, Thin Film, 953R, 0.1%, ±25ppm, 1/10W, 0805	MC008650
Resistor, Thin Film, 365R, 0.1%, ±25ppm, 1/10W, 0805	MC008610	Resistor, Thin Film, 976R, 0.1%, ±25ppm, 1/10W, 0805	MC008651
Resistor, Thin Film, 374R, 0.1%, ±25ppm, 1/10W, 0805	MC008611	Resistor, Thin Film, 1K02, 0.1%, ±25ppm, 1/10W, 0805	MC008653
Resistor, Thin Film, 383R, 0.1%, ±25ppm, 1/10W, 0805	MC008612	Resistor, Thin Film, 1K05, 0.1%, ±25ppm, 1/10W, 0805	MC008654
Resistor, Thin Film, 392R, 0.1%, ±25ppm, 1/10W, 0805	MC008613	Resistor, Thin Film, 1K07, 0.1%, ±25ppm, 1/10W, 0805	MC008655
Resistor, Thin Film, 402R, 0.1%, ±25ppm, 1/10W, 0805	MC008614	Resistor, Thin Film, 1K1, 0.1%, ±25ppm, 1/10W, 0805	MC008656
Resistor, Thin Film, 412R, 0.1%, ±25ppm, 1/10W, 0805	MC008615	Resistor, Thin Film, 1K13, 0.1%, ±25ppm, 1/10W, 0805	MC008657
Resistor, Thin Film, 422R, 0.1%, ±25ppm, 1/10W, 0805	MC008616	Resistor, Thin Film, 1K15, 0.1%, ±25ppm, 1/10W, 0805	MC008658
Resistor, Thin Film, 432R, 0.1%, ±25ppm, 1/10W, 0805	MC008617	Resistor, Thin Film, 1K18, 0.1%, ±25ppm, 1/10W, 0805	MC008659
Resistor, Thin Film, 442R, 0.1%, ±25ppm, 1/10W, 0805	MC008618	Resistor, Thin Film, 1K21, 0.1%, ±25ppm, 1/10W, 0805	MC008660
Resistor, Thin Film, 453R, 0.1%, ±25ppm, 1/10W, 0805	MC008619	Resistor, Thin Film, 1K24, 0.1%, ±25ppm, 1/10W, 0805	MC008661
Resistor, Thin Film, 464R, 0.1%, ±25ppm, 1/10W, 0805	MC008620	Resistor, Thin Film, 1K27, 0.1%, ±25ppm, 1/10W, 0805	MC008662
Resistor, Thin Film, 475R, 0.1%, ±25ppm, 1/10W, 0805	MC008621	Resistor, Thin Film, 1K3, 0.1%, ±25ppm, 1/10W, 0805	MC008663
Resistor, Thin Film, 487R, 0.1%, ±25ppm, 1/10W, 0805	MC008622	Resistor, Thin Film, 1K33, 0.1%, ±25ppm, 1/10W, 0805	MC008664
Resistor, Thin Film, 499R, 0.1%, ±25ppm, 1/10W, 0805	MC008623	Resistor, Thin Film, 1K37, 0.1%, ±25ppm, 1/10W, 0805	MC008665
Resistor, Thin Film, 511R, 0.1%, ±25ppm, 1/10W, 0805	MC008624	Resistor, Thin Film, 1K4, 0.1%, ±25ppm, 1/10W, 0805	MC008666
Resistor, Thin Film, 523R, 0.1%, ±25ppm, 1/10W, 0805	MC008625	Resistor, Thin Film, 1K43, 0.1%, ±25ppm, 1/10W, 0805	MC008667
Resistor, Thin Film, 536R, 0.1%, ±25ppm, 1/10W, 0805	MC008626	Resistor, Thin Film, 1K47, 0.1%, ±25ppm, 1/10W, 0805	MC008668
Resistor, Thin Film, 549R, 0.1%, ±25ppm, 1/10W, 0805	MC008627	Resistor, Thin Film, 1K54, 0.1%, ±25ppm, 1/10W, 0805	MC008670
Resistor, Thin Film, 562R, 0.1%, ±25ppm, 1/10W, 0805	MC008628	Resistor, Thin Film, 1K58, 0.1%, ±25ppm, 1/10W, 0805	MC008671

www.element14.com
www.farnell.com
www.newark.com



Thin Film Precision Chip Resistor

Description	Part Number	Description	Part Number
Resistor, Thin Film, 909K, 0.1%, ±25ppm, 1/10W, 0805	MC008927	Resistor, Thin Film, 16R9, 0.1%, ±25ppm, 1/8W, 1206	MC008969
Resistor, Thin Film, 931K, 0.1%, ±25ppm, 1/10W, 0805	MC008928	Resistor, Thin Film, 17R4, 0.1%, ±25ppm, 1/8W, 1206	MC008970
Resistor, Thin Film, 953K, 0.1%, ±25ppm, 1/10W, 0805	MC008929	Resistor, Thin Film, 17R8, 0.1%, ±25ppm, 1/8W, 1206	MC008971
Resistor, Thin Film, 976K, 0.1%, ±25ppm, 1/10W, 0805	MC008930	Resistor, Thin Film, 18R2, 0.1%, ±25ppm, 1/8W, 1206	MC008972
Resistor, Thin Film, 1M1, 0.1%, ±25ppm, 1/10W, 0805	MC008932	Resistor, Thin Film, 18R7, 0.1%, ±25ppm, 1/8W, 1206	MC008973
Resistor, Thin Film, 1M2, 0.1%, ±25ppm, 1/10W, 0805	MC008933	Resistor, Thin Film, 19R1, 0.1%, ±25ppm, 1/8W, 1206	MC008974
Resistor, Thin Film, 1M3, 0.1%, ±25ppm, 1/10W, 0805	MC008934	Resistor, Thin Film, 19R6, 0.1%, ±25ppm, 1/8W, 1206	MC008975
Resistor, Thin Film, 1M5, 0.1%, ±25ppm, 1/10W, 0805	MC008935	Resistor, Thin Film, 20R, 0.1%, ±25ppm, 1/8W, 1206	MC008976
Resistor, Thin Film, 1M6, 0.1%, ±25ppm, 1/10W, 0805	MC008936	Resistor, Thin Film, 20R5, 0.1%, ±25ppm, 1/8W, 1206	MC008977
Resistor, Thin Film, 1M8, 0.1%, ±25ppm, 1/10W, 0805	MC008937	Resistor, Thin Film, 21R, 0.1%, ±25ppm, 1/8W, 1206	MC008978
Resistor, Thin Film, 2M, 0.1%, ±25ppm, 1/10W, 0805	MC008938	Resistor, Thin Film, 21R5, 0.1%, ±25ppm, 1/8W, 1206	MC008979
Resistor, Thin Film, 4R7, 0.1%, ±25ppm, 1/8W, 1206	MC008939	Resistor, Thin Film, 22R1, 0.1%, ±25ppm, 1/8W, 1206	MC008980
Resistor, Thin Film, 5R1, 0.1%, ±25ppm, 1/8W, 1206	MC008940	Resistor, Thin Film, 22R6, 0.1%, ±25ppm, 1/8W, 1206	MC008981
Resistor, Thin Film, 5R6, 0.1%, ±25ppm, 1/8W, 1206	MC008941	Resistor, Thin Film, 23R2, 0.1%, ±25ppm, 1/8W, 1206	MC008982
Resistor, Thin Film, 6R2, 0.1%, ±25ppm, 1/8W, 1206	MC008942	Resistor, Thin Film, 23R7, 0.1%, ±25ppm, 1/8W, 1206	MC008983
Resistor, Thin Film, 6R8, 0.1%, ±25ppm, 1/8W, 1206	MC008943	Resistor, Thin Film, 24R3, 0.1%, ±25ppm, 1/8W, 1206	MC008984
Resistor, Thin Film, 7R5, 0.1%, ±25ppm, 1/8W, 1206	MC008944	Resistor, Thin Film, 24R9, 0.1%, ±25ppm, 1/8W, 1206	MC008985
Resistor, Thin Film, 8R2, 0.1%, ±25ppm, 1/8W, 1206	MC008945	Resistor, Thin Film, 25R5, 0.1%, ±25ppm, 1/8W, 1206	MC008986
Resistor, Thin Film, 9R1, 0.1%, ±25ppm, 1/8W, 1206	MC008946	Resistor, Thin Film, 26R1, 0.1%, ±25ppm, 1/8W, 1206	MC008987
Resistor, Thin Film, 10R, 0.1%, ±25ppm, 1/8W, 1206	MC008947	Resistor, Thin Film, 26R7, 0.1%, ±25ppm, 1/8W, 1206	MC008988
Resistor, Thin Film, 10R2, 0.1%, ±25ppm, 1/8W, 1206	MC008948	Resistor, Thin Film, 27R4, 0.1%, ±25ppm, 1/8W, 1206	MC008989
Resistor, Thin Film, 10R5, 0.1%, ±25ppm, 1/8W, 1206	MC008949	Resistor, Thin Film, 28R, 0.1%, ±25ppm, 1/8W, 1206	MC008990
Resistor, Thin Film, 10R7, 0.1%, ±25ppm, 1/8W, 1206	MC008950	Resistor, Thin Film, 29R4, 0.1%, ±25ppm, 1/8W, 1206	MC008991
Resistor, Thin Film, 11R, 0.1%, ±25ppm, 1/8W, 1206	MC008951	Resistor, Thin Film, 31R6, 0.1%, ±25ppm, 1/8W, 1206	MC008992
Resistor, Thin Film, 11R3, 0.1%, ±25ppm, 1/8W, 1206	MC008952	Resistor, Thin Film, 32R4, 0.1%, ±25ppm, 1/8W, 1206	MC008993
Resistor, Thin Film, 11R5, 0.1%, ±25ppm, 1/8W, 1206	MC008953	Resistor, Thin Film, 33R2, 0.1%, ±25ppm, 1/8W, 1206	MC008994
Resistor, Thin Film, 11R8, 0.1%, ±25ppm, 1/8W, 1206	MC008954	Resistor, Thin Film, 34R, 0.1%, ±25ppm, 1/8W, 1206	MC008995
Resistor, Thin Film, 12R1, 0.1%, ±25ppm, 1/8W, 1206	MC008955	Resistor, Thin Film, 34R8, 0.1%, ±25ppm, 1/8W, 1206	MC008996
Resistor, Thin Film, 12R4, 0.1%, ±25ppm, 1/8W, 1206	MC008956	Resistor, Thin Film, 35R7, 0.1%, ±25ppm, 1/8W, 1206	MC008997
Resistor, Thin Film, 12R7, 0.1%, ±25ppm, 1/8W, 1206	MC008957	Resistor, Thin Film, 36R5, 0.1%, ±25ppm, 1/8W, 1206	MC008998
Resistor, Thin Film, 13R, 0.1%, ±25ppm, 1/8W, 1206	MC008958	Resistor, Thin Film, 37R4, 0.1%, ±25ppm, 1/8W, 1206	MC008999
Resistor, Thin Film, 13R3, 0.1%, ±25ppm, 1/8W, 1206	MC008959	Resistor, Thin Film, 38R3, 0.1%, ±25ppm, 1/8W, 1206	MC009000
Resistor, Thin Film, 13R7, 0.1%, ±25ppm, 1/8W, 1206	MC008960	Resistor, Thin Film, 39R2, 0.1%, ±25ppm, 1/8W, 1206	MC009001
Resistor, Thin Film, 14R, 0.1%, ±25ppm, 1/8W, 1206	MC008961	Resistor, Thin Film, 40R2, 0.1%, ±25ppm, 1/8W, 1206	MC009002
Resistor, Thin Film, 14R3, 0.1%, ±25ppm, 1/8W, 1206	MC008962	Resistor, Thin Film, 41R2, 0.1%, ±25ppm, 1/8W, 1206	MC009003
Resistor, Thin Film, 14R7, 0.1%, ±25ppm, 1/8W, 1206	MC008963	Resistor, Thin Film, 42R2, 0.1%, ±25ppm, 1/8W, 1206	MC009004
Resistor, Thin Film, 15R, 0.1%, ±25ppm, 1/8W, 1206	MC008964	Resistor, Thin Film, 43R2, 0.1%, ±25ppm, 1/8W, 1206	MC009005
Resistor, Thin Film, 15R4, 0.1%, ±25ppm, 1/8W, 1206	MC008965	Resistor, Thin Film, 44R2, 0.1%, ±25ppm, 1/8W, 1206	MC009006
Resistor, Thin Film, 15R8, 0.1%, ±25ppm, 1/8W, 1206	MC008966	Resistor, Thin Film, 45R3, 0.1%, ±25ppm, 1/8W, 1206	MC009007
Resistor, Thin Film, 16R2, 0.1%, ±25ppm, 1/8W, 1206	MC008967	Resistor, Thin Film, 46R4, 0.1%, ±25ppm, 1/8W, 1206	MC009008
Resistor, Thin Film, 16R5, 0.1%, ±25ppm, 1/8W, 1206	MC008968	Resistor, Thin Film, 47R5, 0.1%, ±25ppm, 1/8W, 1206	MC009009

www.element14.com
www.farnell.com
www.newark.com



Thin Film Precision Chip Resistor

Description	Part Number	Description	Part Number
Resistor, Thin Film, 48R7, 0.1%, ±25ppm, 1/8W, 1206	MC009010	Resistor, Thin Film, 130R, 0.1%, ±25ppm, 1/8W, 1206	MC009051
Resistor, Thin Film, 49R9, 0.1%, ±25ppm, 1/8W, 1206	MC009011	Resistor, Thin Film, 133R, 0.1%, ±25ppm, 1/8W, 1206	MC009052
Resistor, Thin Film, 51R1, 0.1%, ±25ppm, 1/8W, 1206	MC009012	Resistor, Thin Film, 137R, 0.1%, ±25ppm, 1/8W, 1206	MC009053
Resistor, Thin Film, 52R3, 0.1%, ±25ppm, 1/8W, 1206	MC009013	Resistor, Thin Film, 140R, 0.1%, ±25ppm, 1/8W, 1206	MC009054
Resistor, Thin Film, 53R6, 0.1%, ±25ppm, 1/8W, 1206	MC009014	Resistor, Thin Film, 143R, 0.1%, ±25ppm, 1/8W, 1206	MC009055
Resistor, Thin Film, 54R9, 0.1%, ±25ppm, 1/8W, 1206	MC009015	Resistor, Thin Film, 147R, 0.1%, ±25ppm, 1/8W, 1206	MC009056
Resistor, Thin Film, 56R2, 0.1%, ±25ppm, 1/8W, 1206	MC009016	Resistor, Thin Film, 150R, 0.1%, ±25ppm, 1/8W, 1206	MC009057
Resistor, Thin Film, 57R6, 0.1%, ±25ppm, 1/8W, 1206	MC009017	Resistor, Thin Film, 154R, 0.1%, ±25ppm, 1/8W, 1206	MC009058
Resistor, Thin Film, 59R, 0.1%, ±25ppm, 1/8W, 1206	MC009018	Resistor, Thin Film, 158R, 0.1%, ±25ppm, 1/8W, 1206	MC009059
Resistor, Thin Film, 60R4, 0.1%, ±25ppm, 1/8W, 1206	MC009019	Resistor, Thin Film, 162R, 0.1%, ±25ppm, 1/8W, 1206	MC009060
Resistor, Thin Film, 61R9, 0.1%, ±25ppm, 1/8W, 1206	MC009020	Resistor, Thin Film, 165R, 0.1%, ±25ppm, 1/8W, 1206	MC009061
Resistor, Thin Film, 63R4, 0.1%, ±25ppm, 1/8W, 1206	MC009021	Resistor, Thin Film, 169R, 0.1%, ±25ppm, 1/8W, 1206	MC009062
Resistor, Thin Film, 64R9, 0.1%, ±25ppm, 1/8W, 1206	MC009022	Resistor, Thin Film, 174R, 0.1%, ±25ppm, 1/8W, 1206	MC009063
Resistor, Thin Film, 66R5, 0.1%, ±25ppm, 1/8W, 1206	MC009023	Resistor, Thin Film, 178R, 0.1%, ±25ppm, 1/8W, 1206	MC009064
Resistor, Thin Film, 68R1, 0.1%, ±25ppm, 1/8W, 1206	MC009024	Resistor, Thin Film, 182R, 0.1%, ±25ppm, 1/8W, 1206	MC009065
Resistor, Thin Film, 69R8, 0.1%, ±25ppm, 1/8W, 1206	MC009025	Resistor, Thin Film, 187R, 0.1%, ±25ppm, 1/8W, 1206	MC009066
Resistor, Thin Film, 71R5, 0.1%, ±25ppm, 1/8W, 1206	MC009026	Resistor, Thin Film, 191R, 0.1%, ±25ppm, 1/8W, 1206	MC009067
Resistor, Thin Film, 73R2, 0.1%, ±25ppm, 1/8W, 1206	MC009027	Resistor, Thin Film, 196R, 0.1%, ±25ppm, 1/8W, 1206	MC009068
Resistor, Thin Film, 75R, 0.1%, ±25ppm, 1/8W, 1206	MC009028	Resistor, Thin Film, 200R, 0.1%, ±25ppm, 1/8W, 1206	MC009069
Resistor, Thin Film, 76R8, 0.1%, ±25ppm, 1/8W, 1206	MC009029	Resistor, Thin Film, 205R, 0.1%, ±25ppm, 1/8W, 1206	MC009070
Resistor, Thin Film, 78R7, 0.1%, ±25ppm, 1/8W, 1206	MC009030	Resistor, Thin Film, 210R, 0.1%, ±25ppm, 1/8W, 1206	MC009071
Resistor, Thin Film, 80R6, 0.1%, ±25ppm, 1/8W, 1206	MC009031	Resistor, Thin Film, 215R, 0.1%, ±25ppm, 1/8W, 1206	MC009072
Resistor, Thin Film, 82R5, 0.1%, ±25ppm, 1/8W, 1206	MC009032	Resistor, Thin Film, 221R, 0.1%, ±25ppm, 1/8W, 1206	MC009073
Resistor, Thin Film, 84R5, 0.1%, ±25ppm, 1/8W, 1206	MC009033	Resistor, Thin Film, 226R, 0.1%, ±25ppm, 1/8W, 1206	MC009074
Resistor, Thin Film, 86R6, 0.1%, ±25ppm, 1/8W, 1206	MC009034	Resistor, Thin Film, 232R, 0.1%, ±25ppm, 1/8W, 1206	MC009075
Resistor, Thin Film, 88R7, 0.1%, ±25ppm, 1/8W, 1206	MC009035	Resistor, Thin Film, 237R, 0.1%, ±25ppm, 1/8W, 1206	MC009076
Resistor, Thin Film, 90R9, 0.1%, ±25ppm, 1/8W, 1206	MC009036	Resistor, Thin Film, 243R, 0.1%, ±25ppm, 1/8W, 1206	MC009077
Resistor, Thin Film, 93R1, 0.1%, ±25ppm, 1/8W, 1206	MC009037	Resistor, Thin Film, 249R, 0.1%, ±25ppm, 1/8W, 1206	MC009078
Resistor, Thin Film, 95R3, 0.1%, ±25ppm, 1/8W, 1206	MC009038	Resistor, Thin Film, 255R, 0.1%, ±25ppm, 1/8W, 1206	MC009079
Resistor, Thin Film, 97R6, 0.1%, ±25ppm, 1/8W, 1206	MC009039	Resistor, Thin Film, 261R, 0.1%, ±25ppm, 1/8W, 1206	MC009080
Resistor, Thin Film, 100R, 0.1%, ±25ppm, 1/8W, 1206	MC009040	Resistor, Thin Film, 267R, 0.1%, ±25ppm, 1/8W, 1206	MC009081
Resistor, Thin Film, 102R, 0.1%, ±25ppm, 1/8W, 1206	MC009041	Resistor, Thin Film, 274R, 0.1%, ±25ppm, 1/8W, 1206	MC009082
Resistor, Thin Film, 105R, 0.1%, ±25ppm, 1/8W, 1206	MC009042	Resistor, Thin Film, 280R, 0.1%, ±25ppm, 1/8W, 1206	MC009083
Resistor, Thin Film, 107R, 0.1%, ±25ppm, 1/8W, 1206	MC009043	Resistor, Thin Film, 294R, 0.1%, ±25ppm, 1/8W, 1206	MC009084
Resistor, Thin Film, 110R, 0.1%, ±25ppm, 1/8W, 1206	MC009044	Resistor, Thin Film, 316R, 0.1%, ±25ppm, 1/8W, 1206	MC009085
Resistor, Thin Film, 113R, 0.1%, ±25ppm, 1/8W, 1206	MC009045	Resistor, Thin Film, 324R, 0.1%, ±25ppm, 1/8W, 1206	MC009086
Resistor, Thin Film, 115R, 0.1%, ±25ppm, 1/8W, 1206	MC009046	Resistor, Thin Film, 332R, 0.1%, ±25ppm, 1/8W, 1206	MC009087
Resistor, Thin Film, 118R, 0.1%, ±25ppm, 1/8W, 1206	MC009047	Resistor, Thin Film, 340R, 0.1%, ±25ppm, 1/8W, 1206	MC009088
Resistor, Thin Film, 121R, 0.1%, ±25ppm, 1/8W, 1206	MC009048	Resistor, Thin Film, 348R, 0.1%, ±25ppm, 1/8W, 1206	MC009089
Resistor, Thin Film, 124R, 0.1%, ±25ppm, 1/8W, 1206	MC009049	Resistor, Thin Film, 357R, 0.1%, ±25ppm, 1/8W, 1206	MC009090
Resistor, Thin Film, 127R, 0.1%, ±25ppm, 1/8W, 1206	MC009050	Resistor, Thin Film, 365R, 0.1%, ±25ppm, 1/8W, 1206	MC009091

www.element14.com
www.farnell.com
www.newark.com



Thin Film Precision Chip Resistor

Description	Part Number	Description	Part Number
Resistor, Thin Film, 374R, 0.1%, ±25ppm, 1/8W, 1206	MC009092	Resistor, Thin Film, 1K, 0.1%, ±25ppm, 1/8W, 1206	MC009133
Resistor, Thin Film, 383R, 0.1%, ±25ppm, 1/8W, 1206	MC009093	Resistor, Thin Film, 1K02, 0.1%, ±25ppm, 1/8W, 1206	MC009134
Resistor, Thin Film, 392R, 0.1%, ±25ppm, 1/8W, 1206	MC009094	Resistor, Thin Film, 1K05, 0.1%, ±25ppm, 1/8W, 1206	MC009135
Resistor, Thin Film, 402R, 0.1%, ±25ppm, 1/8W, 1206	MC009095	Resistor, Thin Film, 1K07, 0.1%, ±25ppm, 1/8W, 1206	MC009136
Resistor, Thin Film, 412R, 0.1%, ±25ppm, 1/8W, 1206	MC009096	Resistor, Thin Film, 1K1, 0.1%, ±25ppm, 1/8W, 1206	MC009137
Resistor, Thin Film, 422R, 0.1%, ±25ppm, 1/8W, 1206	MC009097	Resistor, Thin Film, 1K13, 0.1%, ±25ppm, 1/8W, 1206	MC009138
Resistor, Thin Film, 432R, 0.1%, ±25ppm, 1/8W, 1206	MC009098	Resistor, Thin Film, 1K15, 0.1%, ±25ppm, 1/8W, 1206	MC009139
Resistor, Thin Film, 442R, 0.1%, ±25ppm, 1/8W, 1206	MC009099	Resistor, Thin Film, 1K18, 0.1%, ±25ppm, 1/8W, 1206	MC009140
Resistor, Thin Film, 453R, 0.1%, ±25ppm, 1/8W, 1206	MC009100	Resistor, Thin Film, 1K21, 0.1%, ±25ppm, 1/8W, 1206	MC009141
Resistor, Thin Film, 464R, 0.1%, ±25ppm, 1/8W, 1206	MC009101	Resistor, Thin Film, 1K24, 0.1%, ±25ppm, 1/8W, 1206	MC009142
Resistor, Thin Film, 475R, 0.1%, ±25ppm, 1/8W, 1206	MC009102	Resistor, Thin Film, 1K27, 0.1%, ±25ppm, 1/8W, 1206	MC009143
Resistor, Thin Film, 487R, 0.1%, ±25ppm, 1/8W, 1206	MC009103	Resistor, Thin Film, 1K3, 0.1%, ±25ppm, 1/8W, 1206	MC009144
Resistor, Thin Film, 499R, 0.1%, ±25ppm, 1/8W, 1206	MC009104	Resistor, Thin Film, 1K33, 0.1%, ±25ppm, 1/8W, 1206	MC009145
Resistor, Thin Film, 511R, 0.1%, ±25ppm, 1/8W, 1206	MC009105	Resistor, Thin Film, 1K37, 0.1%, ±25ppm, 1/8W, 1206	MC009146
Resistor, Thin Film, 523R, 0.1%, ±25ppm, 1/8W, 1206	MC009106	Resistor, Thin Film, 1K4, 0.1%, ±25ppm, 1/8W, 1206	MC009147
Resistor, Thin Film, 536R, 0.1%, ±25ppm, 1/8W, 1206	MC009107	Resistor, Thin Film, 1K43, 0.1%, ±25ppm, 1/8W, 1206	MC009148
Resistor, Thin Film, 549R, 0.1%, ±25ppm, 1/8W, 1206	MC009108	Resistor, Thin Film, 1K47, 0.1%, ±25ppm, 1/8W, 1206	MC009149
Resistor, Thin Film, 562R, 0.1%, ±25ppm, 1/8W, 1206	MC009109	Resistor, Thin Film, 1K5, 0.1%, ±25ppm, 1/8W, 1206	MC009150
Resistor, Thin Film, 576R, 0.1%, ±25ppm, 1/8W, 1206	MC009110	Resistor, Thin Film, 1K54, 0.1%, ±25ppm, 1/8W, 1206	MC009151
Resistor, Thin Film, 590R, 0.1%, ±25ppm, 1/8W, 1206	MC009111	Resistor, Thin Film, 1K58, 0.1%, ±25ppm, 1/8W, 1206	MC009152
Resistor, Thin Film, 604R, 0.1%, ±25ppm, 1/8W, 1206	MC009112	Resistor, Thin Film, 1K62, 0.1%, ±25ppm, 1/8W, 1206	MC009153
Resistor, Thin Film, 619R, 0.1%, ±25ppm, 1/8W, 1206	MC009113	Resistor, Thin Film, 1K65, 0.1%, ±25ppm, 1/8W, 1206	MC009154
Resistor, Thin Film, 634R, 0.1%, ±25ppm, 1/8W, 1206	MC009114	Resistor, Thin Film, 1K69, 0.1%, ±25ppm, 1/8W, 1206	MC009155
Resistor, Thin Film, 649R, 0.1%, ±25ppm, 1/8W, 1206	MC009115	Resistor, Thin Film, 1K74, 0.1%, ±25ppm, 1/8W, 1206	MC009156
Resistor, Thin Film, 665R, 0.1%, ±25ppm, 1/8W, 1206	MC009116	Resistor, Thin Film, 1K78, 0.1%, ±25ppm, 1/8W, 1206	MC009157
Resistor, Thin Film, 681R, 0.1%, ±25ppm, 1/8W, 1206	MC009117	Resistor, Thin Film, 1K82, 0.1%, ±25ppm, 1/8W, 1206	MC009158
Resistor, Thin Film, 698R, 0.1%, ±25ppm, 1/8W, 1206	MC009118	Resistor, Thin Film, 1K87, 0.1%, ±25ppm, 1/8W, 1206	MC009159
Resistor, Thin Film, 715R, 0.1%, ±25ppm, 1/8W, 1206	MC009119	Resistor, Thin Film, 1K91, 0.1%, ±25ppm, 1/8W, 1206	MC009160
Resistor, Thin Film, 732R, 0.1%, ±25ppm, 1/8W, 1206	MC009120	Resistor, Thin Film, 1K96, 0.1%, ±25ppm, 1/8W, 1206	MC009161
Resistor, Thin Film, 750R, 0.1%, ±25ppm, 1/8W, 1206	MC009121	Resistor, Thin Film, 2K, 0.1%, ±25ppm, 1/8W, 1206	MC009162
Resistor, Thin Film, 768R, 0.1%, ±25ppm, 1/8W, 1206	MC009122	Resistor, Thin Film, 2K05, 0.1%, ±25ppm, 1/8W, 1206	MC009163
Resistor, Thin Film, 787R, 0.1%, ±25ppm, 1/8W, 1206	MC009123	Resistor, Thin Film, 2K1, 0.1%, ±25ppm, 1/8W, 1206	MC009164
Resistor, Thin Film, 806R, 0.1%, ±25ppm, 1/8W, 1206	MC009124	Resistor, Thin Film, 2K15, 0.1%, ±25ppm, 1/8W, 1206	MC009165
Resistor, Thin Film, 825R, 0.1%, ±25ppm, 1/8W, 1206	MC009125	Resistor, Thin Film, 2K21, 0.1%, ±25ppm, 1/8W, 1206	MC009166
Resistor, Thin Film, 845R, 0.1%, ±25ppm, 1/8W, 1206	MC009126	Resistor, Thin Film, 2K26, 0.1%, ±25ppm, 1/8W, 1206	MC009167
Resistor, Thin Film, 866R, 0.1%, ±25ppm, 1/8W, 1206	MC009127	Resistor, Thin Film, 2K32, 0.1%, ±25ppm, 1/8W, 1206	MC009168
Resistor, Thin Film, 887R, 0.1%, ±25ppm, 1/8W, 1206	MC009128	Resistor, Thin Film, 2K37, 0.1%, ±25ppm, 1/8W, 1206	MC009169
Resistor, Thin Film, 909R, 0.1%, ±25ppm, 1/8W, 1206	MC009129	Resistor, Thin Film, 2K43, 0.1%, ±25ppm, 1/8W, 1206	MC009170
Resistor, Thin Film, 931R, 0.1%, ±25ppm, 1/8W, 1206	MC009130	Resistor, Thin Film, 2K49, 0.1%, ±25ppm, 1/8W, 1206	MC009171
Resistor, Thin Film, 953R, 0.1%, ±25ppm, 1/8W, 1206	MC009131	Resistor, Thin Film, 2K55, 0.1%, ±25ppm, 1/8W, 1206	MC009172
Resistor, Thin Film, 976R, 0.1%, ±25ppm, 1/8W, 1206	MC009132	Resistor, Thin Film, 2K61, 0.1%, ±25ppm, 1/8W, 1206	MC009173

www.element14.com
www.farnell.com
www.newark.com



Thin Film Precision Chip Resistor

Description	Part Number	Description	Part Number
Resistor, Thin Film, 2K67, 0.1%, ±25ppm, 1/8W, 1206	MC009174	Resistor, Thin Film, 7K68, 0.1%, ±25ppm, 1/8W, 1206	MC009215
Resistor, Thin Film, 2K74, 0.1%, ±25ppm, 1/8W, 1206	MC009175	Resistor, Thin Film, 7K87, 0.1%, ±25ppm, 1/8W, 1206	MC009216
Resistor, Thin Film, 2K8, 0.1%, ±25ppm, 1/8W, 1206	MC009176	Resistor, Thin Film, 8K06, 0.1%, ±25ppm, 1/8W, 1206	MC009217
Resistor, Thin Film, 2K94, 0.1%, ±25ppm, 1/8W, 1206	MC009177	Resistor, Thin Film, 8K25, 0.1%, ±25ppm, 1/8W, 1206	MC009218
Resistor, Thin Film, 3K16, 0.1%, ±25ppm, 1/8W, 1206	MC009178	Resistor, Thin Film, 8K45, 0.1%, ±25ppm, 1/8W, 1206	MC009219
Resistor, Thin Film, 3K24, 0.1%, ±25ppm, 1/8W, 1206	MC009179	Resistor, Thin Film, 8K66, 0.1%, ±25ppm, 1/8W, 1206	MC009220
Resistor, Thin Film, 3K32, 0.1%, ±25ppm, 1/8W, 1206	MC009180	Resistor, Thin Film, 8K87, 0.1%, ±25ppm, 1/8W, 1206	MC009221
Resistor, Thin Film, 3K4, 0.1%, ±25ppm, 1/8W, 1206	MC009181	Resistor, Thin Film, 9K09, 0.1%, ±25ppm, 1/8W, 1206	MC009222
Resistor, Thin Film, 3K48, 0.1%, ±25ppm, 1/8W, 1206	MC009182	Resistor, Thin Film, 9K31, 0.1%, ±25ppm, 1/8W, 1206	MC009223
Resistor, Thin Film, 3K57, 0.1%, ±25ppm, 1/8W, 1206	MC009183	Resistor, Thin Film, 9K53, 0.1%, ±25ppm, 1/8W, 1206	MC009224
Resistor, Thin Film, 3K65, 0.1%, ±25ppm, 1/8W, 1206	MC009184	Resistor, Thin Film, 9K76, 0.1%, ±25ppm, 1/8W, 1206	MC009225
Resistor, Thin Film, 3K74, 0.1%, ±25ppm, 1/8W, 1206	MC009185	Resistor, Thin Film, 10K, 0.1%, ±25ppm, 1/8W, 1206	MC009226
Resistor, Thin Film, 3K83, 0.1%, ±25ppm, 1/8W, 1206	MC009186	Resistor, Thin Film, 10K2, 0.1%, ±25ppm, 1/8W, 1206	MC009227
Resistor, Thin Film, 3K92, 0.1%, ±25ppm, 1/8W, 1206	MC009187	Resistor, Thin Film, 10K5, 0.1%, ±25ppm, 1/8W, 1206	MC009228
Resistor, Thin Film, 4K02, 0.1%, ±25ppm, 1/8W, 1206	MC009188	Resistor, Thin Film, 10K7, 0.1%, ±25ppm, 1/8W, 1206	MC009229
Resistor, Thin Film, 4K12, 0.1%, ±25ppm, 1/8W, 1206	MC009189	Resistor, Thin Film, 11K, 0.1%, ±25ppm, 1/8W, 1206	MC009230
Resistor, Thin Film, 4K22, 0.1%, ±25ppm, 1/8W, 1206	MC009190	Resistor, Thin Film, 11K3, 0.1%, ±25ppm, 1/8W, 1206	MC009231
Resistor, Thin Film, 4K32, 0.1%, ±25ppm, 1/8W, 1206	MC009191	Resistor, Thin Film, 11K5, 0.1%, ±25ppm, 1/8W, 1206	MC009232
Resistor, Thin Film, 4K42, 0.1%, ±25ppm, 1/8W, 1206	MC009192	Resistor, Thin Film, 11K8, 0.1%, ±25ppm, 1/8W, 1206	MC009233
Resistor, Thin Film, 4K53, 0.1%, ±25ppm, 1/8W, 1206	MC009193	Resistor, Thin Film, 12K1, 0.1%, ±25ppm, 1/8W, 1206	MC009234
Resistor, Thin Film, 4K64, 0.1%, ±25ppm, 1/8W, 1206	MC009194	Resistor, Thin Film, 12K4, 0.1%, ±25ppm, 1/8W, 1206	MC009235
Resistor, Thin Film, 4K75, 0.1%, ±25ppm, 1/8W, 1206	MC009195	Resistor, Thin Film, 12K7, 0.1%, ±25ppm, 1/8W, 1206	MC009236
Resistor, Thin Film, 4K87, 0.1%, ±25ppm, 1/8W, 1206	MC009196	Resistor, Thin Film, 13K, 0.1%, ±25ppm, 1/8W, 1206	MC009237
Resistor, Thin Film, 4K99, 0.1%, ±25ppm, 1/8W, 1206	MC009197	Resistor, Thin Film, 13K3, 0.1%, ±25ppm, 1/8W, 1206	MC009238
Resistor, Thin Film, 5K11, 0.1%, ±25ppm, 1/8W, 1206	MC009198	Resistor, Thin Film, 13K7, 0.1%, ±25ppm, 1/8W, 1206	MC009239
Resistor, Thin Film, 5K23, 0.1%, ±25ppm, 1/8W, 1206	MC009199	Resistor, Thin Film, 14K, 0.1%, ±25ppm, 1/8W, 1206	MC009240
Resistor, Thin Film, 5K36, 0.1%, ±25ppm, 1/8W, 1206	MC009200	Resistor, Thin Film, 14K3, 0.1%, ±25ppm, 1/8W, 1206	MC009241
Resistor, Thin Film, 5K49, 0.1%, ±25ppm, 1/8W, 1206	MC009201	Resistor, Thin Film, 14K7, 0.1%, ±25ppm, 1/8W, 1206	MC009242
Resistor, Thin Film, 5K62, 0.1%, ±25ppm, 1/8W, 1206	MC009202	Resistor, Thin Film, 15K, 0.1%, ±25ppm, 1/8W, 1206	MC009243
Resistor, Thin Film, 5K76, 0.1%, ±25ppm, 1/8W, 1206	MC009203	Resistor, Thin Film, 15K4, 0.1%, ±25ppm, 1/8W, 1206	MC009244
Resistor, Thin Film, 5K9, 0.1%, ±25ppm, 1/8W, 1206	MC009204	Resistor, Thin Film, 15K8, 0.1%, ±25ppm, 1/8W, 1206	MC009245
Resistor, Thin Film, 6K04, 0.1%, ±25ppm, 1/8W, 1206	MC009205	Resistor, Thin Film, 16K2, 0.1%, ±25ppm, 1/8W, 1206	MC009246
Resistor, Thin Film, 6K19, 0.1%, ±25ppm, 1/8W, 1206	MC009206	Resistor, Thin Film, 16K5, 0.1%, ±25ppm, 1/8W, 1206	MC009247
Resistor, Thin Film, 6K34, 0.1%, ±25ppm, 1/8W, 1206	MC009207	Resistor, Thin Film, 16K9, 0.1%, ±25ppm, 1/8W, 1206	MC009248
Resistor, Thin Film, 6K49, 0.1%, ±25ppm, 1/8W, 1206	MC009208	Resistor, Thin Film, 17K4, 0.1%, ±25ppm, 1/8W, 1206	MC009249
Resistor, Thin Film, 6K65, 0.1%, ±25ppm, 1/8W, 1206	MC009209	Resistor, Thin Film, 17K8, 0.1%, ±25ppm, 1/8W, 1206	MC009250
Resistor, Thin Film, 6K81, 0.1%, ±25ppm, 1/8W, 1206	MC009210	Resistor, Thin Film, 18K2, 0.1%, ±25ppm, 1/8W, 1206	MC009251
Resistor, Thin Film, 6K98, 0.1%, ±25ppm, 1/8W, 1206	MC009211	Resistor, Thin Film, 18K7, 0.1%, ±25ppm, 1/8W, 1206	MC009252
Resistor, Thin Film, 7K15, 0.1%, ±25ppm, 1/8W, 1206	MC009212	Resistor, Thin Film, 19K1, 0.1%, ±25ppm, 1/8W, 1206	MC009253
Resistor, Thin Film, 7K32, 0.1%, ±25ppm, 1/8W, 1206	MC009213	Resistor, Thin Film, 19K6, 0.1%, ±25ppm, 1/8W, 1206	MC009254
Resistor, Thin Film, 7K5, 0.1%, ±25ppm, 1/8W, 1206	MC009214	Resistor, Thin Film, 20K, 0.1%, ±25ppm, 1/8W, 1206	MC009255

Thin Film Precision Chip Resistor

Description	Part Number	Description	Part Number
Resistor, Thin Film, 20K5, 0.1%, ±25ppm, 1/8W, 1206	MC009256	Resistor, Thin Film, 59K, 0.1%, ±25ppm, 1/8W, 1206	MC009297
Resistor, Thin Film, 21K, 0.1%, ±25ppm, 1/8W, 1206	MC009257	Resistor, Thin Film, 60K4, 0.1%, ±25ppm, 1/8W, 1206	MC009298
Resistor, Thin Film, 21K5, 0.1%, ±25ppm, 1/8W, 1206	MC009258	Resistor, Thin Film, 61K9, 0.1%, ±25ppm, 1/8W, 1206	MC009299
Resistor, Thin Film, 22K1, 0.1%, ±25ppm, 1/8W, 1206	MC009259	Resistor, Thin Film, 63K4, 0.1%, ±25ppm, 1/8W, 1206	MC009300
Resistor, Thin Film, 22K6, 0.1%, ±25ppm, 1/8W, 1206	MC009260	Resistor, Thin Film, 64K9, 0.1%, ±25ppm, 1/8W, 1206	MC009301
Resistor, Thin Film, 23K2, 0.1%, ±25ppm, 1/8W, 1206	MC009261	Resistor, Thin Film, 66K5, 0.1%, ±25ppm, 1/8W, 1206	MC009302
Resistor, Thin Film, 23K7, 0.1%, ±25ppm, 1/8W, 1206	MC009262	Resistor, Thin Film, 68K1, 0.1%, ±25ppm, 1/8W, 1206	MC009303
Resistor, Thin Film, 24K3, 0.1%, ±25ppm, 1/8W, 1206	MC009263	Resistor, Thin Film, 69K8, 0.1%, ±25ppm, 1/8W, 1206	MC009304
Resistor, Thin Film, 24K9, 0.1%, ±25ppm, 1/8W, 1206	MC009264	Resistor, Thin Film, 71K5, 0.1%, ±25ppm, 1/8W, 1206	MC009305
Resistor, Thin Film, 25K5, 0.1%, ±25ppm, 1/8W, 1206	MC009265	Resistor, Thin Film, 73K2, 0.1%, ±25ppm, 1/8W, 1206	MC009306
Resistor, Thin Film, 26K1, 0.1%, ±25ppm, 1/8W, 1206	MC009266	Resistor, Thin Film, 75K, 0.1%, ±25ppm, 1/8W, 1206	MC009307
Resistor, Thin Film, 26K7, 0.1%, ±25ppm, 1/8W, 1206	MC009267	Resistor, Thin Film, 76K8, 0.1%, ±25ppm, 1/8W, 1206	MC009308
Resistor, Thin Film, 27K4, 0.1%, ±25ppm, 1/8W, 1206	MC009268	Resistor, Thin Film, 78K7, 0.1%, ±25ppm, 1/8W, 1206	MC009309
Resistor, Thin Film, 28K, 0.1%, ±25ppm, 1/8W, 1206	MC009269	Resistor, Thin Film, 80K6, 0.1%, ±25ppm, 1/8W, 1206	MC009310
Resistor, Thin Film, 29K4, 0.1%, ±25ppm, 1/8W, 1206	MC009270	Resistor, Thin Film, 82K5, 0.1%, ±25ppm, 1/8W, 1206	MC009311
Resistor, Thin Film, 31K6, 0.1%, ±25ppm, 1/8W, 1206	MC009271	Resistor, Thin Film, 84K5, 0.1%, ±25ppm, 1/8W, 1206	MC009312
Resistor, Thin Film, 32K4, 0.1%, ±25ppm, 1/8W, 1206	MC009272	Resistor, Thin Film, 86K6, 0.1%, ±25ppm, 1/8W, 1206	MC009313
Resistor, Thin Film, 33K2, 0.1%, ±25ppm, 1/8W, 1206	MC009273	Resistor, Thin Film, 88K7, 0.1%, ±25ppm, 1/8W, 1206	MC009314
Resistor, Thin Film, 34K, 0.1%, ±25ppm, 1/8W, 1206	MC009274	Resistor, Thin Film, 90K9, 0.1%, ±25ppm, 1/8W, 1206	MC009315
Resistor, Thin Film, 34K8, 0.1%, ±25ppm, 1/8W, 1206	MC009275	Resistor, Thin Film, 93K1, 0.1%, ±25ppm, 1/8W, 1206	MC009316
Resistor, Thin Film, 35K7, 0.1%, ±25ppm, 1/8W, 1206	MC009276	Resistor, Thin Film, 95K3, 0.1%, ±25ppm, 1/8W, 1206	MC009317
Resistor, Thin Film, 36K5, 0.1%, ±25ppm, 1/8W, 1206	MC009277	Resistor, Thin Film, 97K6, 0.1%, ±25ppm, 1/8W, 1206	MC009318
Resistor, Thin Film, 37K4, 0.1%, ±25ppm, 1/8W, 1206	MC009278	Resistor, Thin Film, 100K, 0.1%, ±25ppm, 1/8W, 1206	MC009319
Resistor, Thin Film, 38K3, 0.1%, ±25ppm, 1/8W, 1206	MC009279	Resistor, Thin Film, 102K, 0.1%, ±25ppm, 1/8W, 1206	MC009320
Resistor, Thin Film, 39K2, 0.1%, ±25ppm, 1/8W, 1206	MC009280	Resistor, Thin Film, 105K, 0.1%, ±25ppm, 1/8W, 1206	MC009321
Resistor, Thin Film, 40K2, 0.1%, ±25ppm, 1/8W, 1206	MC009281	Resistor, Thin Film, 107K, 0.1%, ±25ppm, 1/8W, 1206	MC009322
Resistor, Thin Film, 41K2, 0.1%, ±25ppm, 1/8W, 1206	MC009282	Resistor, Thin Film, 110K, 0.1%, ±25ppm, 1/8W, 1206	MC009323
Resistor, Thin Film, 42K2, 0.1%, ±25ppm, 1/8W, 1206	MC009283	Resistor, Thin Film, 113K, 0.1%, ±25ppm, 1/8W, 1206	MC009324
Resistor, Thin Film, 43K2, 0.1%, ±25ppm, 1/8W, 1206	MC009284	Resistor, Thin Film, 115K, 0.1%, ±25ppm, 1/8W, 1206	MC009325
Resistor, Thin Film, 44K2, 0.1%, ±25ppm, 1/8W, 1206	MC009285	Resistor, Thin Film, 118K, 0.1%, ±25ppm, 1/8W, 1206	MC009326
Resistor, Thin Film, 45K3, 0.1%, ±25ppm, 1/8W, 1206	MC009286	Resistor, Thin Film, 121K, 0.1%, ±25ppm, 1/8W, 1206	MC009327
Resistor, Thin Film, 46K4, 0.1%, ±25ppm, 1/8W, 1206	MC009287	Resistor, Thin Film, 124K, 0.1%, ±25ppm, 1/8W, 1206	MC009328
Resistor, Thin Film, 47K5, 0.1%, ±25ppm, 1/8W, 1206	MC009288	Resistor, Thin Film, 127K, 0.1%, ±25ppm, 1/8W, 1206	MC009329
Resistor, Thin Film, 48K7, 0.1%, ±25ppm, 1/8W, 1206	MC009289	Resistor, Thin Film, 130K, 0.1%, ±25ppm, 1/8W, 1206	MC009330
Resistor, Thin Film, 49K9, 0.1%, ±25ppm, 1/8W, 1206	MC009290	Resistor, Thin Film, 133K, 0.1%, ±25ppm, 1/8W, 1206	MC009331
Resistor, Thin Film, 51K1, 0.1%, ±25ppm, 1/8W, 1206	MC009291	Resistor, Thin Film, 137K, 0.1%, ±25ppm, 1/8W, 1206	MC009332
Resistor, Thin Film, 52K3, 0.1%, ±25ppm, 1/8W, 1206	MC009292	Resistor, Thin Film, 140K, 0.1%, ±25ppm, 1/8W, 1206	MC009333
Resistor, Thin Film, 53K6, 0.1%, ±25ppm, 1/8W, 1206	MC009293	Resistor, Thin Film, 143K, 0.1%, ±25ppm, 1/8W, 1206	MC009334
Resistor, Thin Film, 54K9, 0.1%, ±25ppm, 1/8W, 1206	MC009294	Resistor, Thin Film, 147K, 0.1%, ±25ppm, 1/8W, 1206	MC009335
Resistor, Thin Film, 56K2, 0.1%, ±25ppm, 1/8W, 1206	MC009295	Resistor, Thin Film, 150K, 0.1%, ±25ppm, 1/8W, 1206	MC009336
Resistor, Thin Film, 57K6, 0.1%, ±25ppm, 1/8W, 1206	MC009296	Resistor, Thin Film, 154K, 0.1%, ±25ppm, 1/8W, 1206	MC009337

www.element14.com
www.farnell.com
www.newark.com



Thin Film Precision Chip Resistor

Description	Part Number	Description	Part Number
Resistor, Thin Film, 158K, 0.1%, ±25ppm, 1/8W, 1206	MC009338	Resistor, Thin Film, 453K, 0.1%, ±25ppm, 1/8W, 1206	MC009379
Resistor, Thin Film, 162K, 0.1%, ±25ppm, 1/8W, 1206	MC009339	Resistor, Thin Film, 464K, 0.1%, ±25ppm, 1/8W, 1206	MC009380
Resistor, Thin Film, 165K, 0.1%, ±25ppm, 1/8W, 1206	MC009340	Resistor, Thin Film, 475K, 0.1%, ±25ppm, 1/8W, 1206	MC009381
Resistor, Thin Film, 169K, 0.1%, ±25ppm, 1/8W, 1206	MC009341	Resistor, Thin Film, 487K, 0.1%, ±25ppm, 1/8W, 1206	MC009382
Resistor, Thin Film, 174K, 0.1%, ±25ppm, 1/8W, 1206	MC009342	Resistor, Thin Film, 499K, 0.1%, ±25ppm, 1/8W, 1206	MC009383
Resistor, Thin Film, 178K, 0.1%, ±25ppm, 1/8W, 1206	MC009343	Resistor, Thin Film, 511K, 0.1%, ±25ppm, 1/8W, 1206	MC009384
Resistor, Thin Film, 182K, 0.1%, ±25ppm, 1/8W, 1206	MC009344	Resistor, Thin Film, 523K, 0.1%, ±25ppm, 1/8W, 1206	MC009385
Resistor, Thin Film, 187K, 0.1%, ±25ppm, 1/8W, 1206	MC009345	Resistor, Thin Film, 536K, 0.1%, ±25ppm, 1/8W, 1206	MC009386
Resistor, Thin Film, 191K, 0.1%, ±25ppm, 1/8W, 1206	MC009346	Resistor, Thin Film, 549K, 0.1%, ±25ppm, 1/8W, 1206	MC009387
Resistor, Thin Film, 196K, 0.1%, ±25ppm, 1/8W, 1206	MC009347	Resistor, Thin Film, 562K, 0.1%, ±25ppm, 1/8W, 1206	MC009388
Resistor, Thin Film, 200K, 0.1%, ±25ppm, 1/8W, 1206	MC009348	Resistor, Thin Film, 576K, 0.1%, ±25ppm, 1/8W, 1206	MC009389
Resistor, Thin Film, 205K, 0.1%, ±25ppm, 1/8W, 1206	MC009349	Resistor, Thin Film, 590K, 0.1%, ±25ppm, 1/8W, 1206	MC009390
Resistor, Thin Film, 210K, 0.1%, ±25ppm, 1/8W, 1206	MC009350	Resistor, Thin Film, 604K, 0.1%, ±25ppm, 1/8W, 1206	MC009391
Resistor, Thin Film, 215K, 0.1%, ±25ppm, 1/8W, 1206	MC009351	Resistor, Thin Film, 619K, 0.1%, ±25ppm, 1/8W, 1206	MC009392
Resistor, Thin Film, 221K, 0.1%, ±25ppm, 1/8W, 1206	MC009352	Resistor, Thin Film, 634K, 0.1%, ±25ppm, 1/8W, 1206	MC009393
Resistor, Thin Film, 226K, 0.1%, ±25ppm, 1/8W, 1206	MC009353	Resistor, Thin Film, 649K, 0.1%, ±25ppm, 1/8W, 1206	MC009394
Resistor, Thin Film, 232K, 0.1%, ±25ppm, 1/8W, 1206	MC009354	Resistor, Thin Film, 665K, 0.1%, ±25ppm, 1/8W, 1206	MC009395
Resistor, Thin Film, 237K, 0.1%, ±25ppm, 1/8W, 1206	MC009355	Resistor, Thin Film, 681K, 0.1%, ±25ppm, 1/8W, 1206	MC009396
Resistor, Thin Film, 243K, 0.1%, ±25ppm, 1/8W, 1206	MC009356	Resistor, Thin Film, 698K, 0.1%, ±25ppm, 1/8W, 1206	MC009397
Resistor, Thin Film, 249K, 0.1%, ±25ppm, 1/8W, 1206	MC009357	Resistor, Thin Film, 715K, 0.1%, ±25ppm, 1/8W, 1206	MC009398
Resistor, Thin Film, 255K, 0.1%, ±25ppm, 1/8W, 1206	MC009358	Resistor, Thin Film, 732K, 0.1%, ±25ppm, 1/8W, 1206	MC009399
Resistor, Thin Film, 261K, 0.1%, ±25ppm, 1/8W, 1206	MC009359	Resistor, Thin Film, 750K, 0.1%, ±25ppm, 1/8W, 1206	MC009400
Resistor, Thin Film, 267K, 0.1%, ±25ppm, 1/8W, 1206	MC009360	Resistor, Thin Film, 768K, 0.1%, ±25ppm, 1/8W, 1206	MC009401
Resistor, Thin Film, 274K, 0.1%, ±25ppm, 1/8W, 1206	MC009361	Resistor, Thin Film, 787K, 0.1%, ±25ppm, 1/8W, 1206	MC009402
Resistor, Thin Film, 280K, 0.1%, ±25ppm, 1/8W, 1206	MC009362	Resistor, Thin Film, 806K, 0.1%, ±25ppm, 1/8W, 1206	MC009403
Resistor, Thin Film, 294K, 0.1%, ±25ppm, 1/8W, 1206	MC009363	Resistor, Thin Film, 825K, 0.1%, ±25ppm, 1/8W, 1206	MC009404
Resistor, Thin Film, 316K, 0.1%, ±25ppm, 1/8W, 1206	MC009364	Resistor, Thin Film, 845K, 0.1%, ±25ppm, 1/8W, 1206	MC009405
Resistor, Thin Film, 324K, 0.1%, ±25ppm, 1/8W, 1206	MC009365	Resistor, Thin Film, 866K, 0.1%, ±25ppm, 1/8W, 1206	MC009406
Resistor, Thin Film, 332K, 0.1%, ±25ppm, 1/8W, 1206	MC009366	Resistor, Thin Film, 887K, 0.1%, ±25ppm, 1/8W, 1206	MC009407
Resistor, Thin Film, 340K, 0.1%, ±25ppm, 1/8W, 1206	MC009367	Resistor, Thin Film, 909K, 0.1%, ±25ppm, 1/8W, 1206	MC009408
Resistor, Thin Film, 348K, 0.1%, ±25ppm, 1/8W, 1206	MC009368	Resistor, Thin Film, 931K, 0.1%, ±25ppm, 1/8W, 1206	MC009409
Resistor, Thin Film, 357K, 0.1%, ±25ppm, 1/8W, 1206	MC009369	Resistor, Thin Film, 953K, 0.1%, ±25ppm, 1/8W, 1206	MC009410
Resistor, Thin Film, 365K, 0.1%, ±25ppm, 1/8W, 1206	MC009370	Resistor, Thin Film, 976K, 0.1%, ±25ppm, 1/8W, 1206	MC009411
Resistor, Thin Film, 374K, 0.1%, ±25ppm, 1/8W, 1206	MC009371	Resistor, Thin Film, 1M, 0.1%, ±25ppm, 1/8W, 1206	MC009412
Resistor, Thin Film, 383K, 0.1%, ±25ppm, 1/8W, 1206	MC009372	Resistor, Thin Film, 1M1, 0.1%, ±25ppm, 1/8W, 1206	MC009413
Resistor, Thin Film, 392K, 0.1%, ±25ppm, 1/8W, 1206	MC009373	Resistor, Thin Film, 1M2, 0.1%, ±25ppm, 1/8W, 1206	MC009414
Resistor, Thin Film, 402K, 0.1%, ±25ppm, 1/8W, 1206	MC009374	Resistor, Thin Film, 1M3, 0.1%, ±25ppm, 1/8W, 1206	MC009415
Resistor, Thin Film, 412K, 0.1%, ±25ppm, 1/8W, 1206	MC009375	Resistor, Thin Film, 1M5, 0.1%, ±25ppm, 1/8W, 1206	MC009416
Resistor, Thin Film, 422K, 0.1%, ±25ppm, 1/8W, 1206	MC009376	Resistor, Thin Film, 1M6, 0.1%, ±25ppm, 1/8W, 1206	MC009417
Resistor, Thin Film, 432K, 0.1%, ±25ppm, 1/8W, 1206	MC009377	Resistor, Thin Film, 1M8, 0.1%, ±25ppm, 1/8W, 1206	MC009418
Resistor, Thin Film, 442K, 0.1%, ±25ppm, 1/8W, 1206	MC009378	Resistor, Thin Film, 2M, 0.1%, ±25ppm, 1/8W, 1206	MC009419

www.element14.com
www.farnell.com
www.newark.com



Thin Film Precision Chip Resistor

Description	Part Number	Description	Part Number
Resistor, Thin Film, 2M4, 0.1%, ±25ppm, 1/8W, 1206	MC009420	Resistor, Thin Film, 21R, 0.1%, ±25ppm, 1/4W, 1210	MC009461
Resistor, Thin Film, 2M49, 0.1%, ±25ppm, 1/8W, 1206	MC009421	Resistor, Thin Film, 21R5, 0.1%, ±25ppm, 1/4W, 1210	MC009462
Resistor, Thin Film, 4R7, 0.1%, ±25ppm, 1/4W, 1210	MC009422	Resistor, Thin Film, 22R1, 0.1%, ±25ppm, 1/4W, 1210	MC009463
Resistor, Thin Film, 5R1, 0.1%, ±25ppm, 1/4W, 1210	MC009423	Resistor, Thin Film, 22R6, 0.1%, ±25ppm, 1/4W, 1210	MC009464
Resistor, Thin Film, 5R6, 0.1%, ±25ppm, 1/4W, 1210	MC009424	Resistor, Thin Film, 23R2, 0.1%, ±25ppm, 1/4W, 1210	MC009465
Resistor, Thin Film, 6R2, 0.1%, ±25ppm, 1/4W, 1210	MC009425	Resistor, Thin Film, 23R7, 0.1%, ±25ppm, 1/4W, 1210	MC009466
Resistor, Thin Film, 6R8, 0.1%, ±25ppm, 1/4W, 1210	MC009426	Resistor, Thin Film, 24R3, 0.1%, ±25ppm, 1/4W, 1210	MC009467
Resistor, Thin Film, 7R5, 0.1%, ±25ppm, 1/4W, 1210	MC009427	Resistor, Thin Film, 24R9, 0.1%, ±25ppm, 1/4W, 1210	MC009468
Resistor, Thin Film, 8R2, 0.1%, ±25ppm, 1/4W, 1210	MC009428	Resistor, Thin Film, 25R5, 0.1%, ±25ppm, 1/4W, 1210	MC009469
Resistor, Thin Film, 9R1, 0.1%, ±25ppm, 1/4W, 1210	MC009429	Resistor, Thin Film, 26R1, 0.1%, ±25ppm, 1/4W, 1210	MC009470
Resistor, Thin Film, 10R, 0.1%, ±25ppm, 1/4W, 1210	MC009430	Resistor, Thin Film, 26R7, 0.1%, ±25ppm, 1/4W, 1210	MC009471
Resistor, Thin Film, 10R2, 0.1%, ±25ppm, 1/4W, 1210	MC009431	Resistor, Thin Film, 27R4, 0.1%, ±25ppm, 1/4W, 1210	MC009472
Resistor, Thin Film, 10R5, 0.1%, ±25ppm, 1/4W, 1210	MC009432	Resistor, Thin Film, 28R, 0.1%, ±25ppm, 1/4W, 1210	MC009473
Resistor, Thin Film, 10R7, 0.1%, ±25ppm, 1/4W, 1210	MC009433	Resistor, Thin Film, 29R4, 0.1%, ±25ppm, 1/4W, 1210	MC009474
Resistor, Thin Film, 11R, 0.1%, ±25ppm, 1/4W, 1210	MC009434	Resistor, Thin Film, 31R6, 0.1%, ±25ppm, 1/4W, 1210	MC009475
Resistor, Thin Film, 11R3, 0.1%, ±25ppm, 1/4W, 1210	MC009435	Resistor, Thin Film, 32R4, 0.1%, ±25ppm, 1/4W, 1210	MC009476
Resistor, Thin Film, 11R5, 0.1%, ±25ppm, 1/4W, 1210	MC009436	Resistor, Thin Film, 33R2, 0.1%, ±25ppm, 1/4W, 1210	MC009477
Resistor, Thin Film, 11R8, 0.1%, ±25ppm, 1/4W, 1210	MC009437	Resistor, Thin Film, 34R, 0.1%, ±25ppm, 1/4W, 1210	MC009478
Resistor, Thin Film, 12R1, 0.1%, ±25ppm, 1/4W, 1210	MC009438	Resistor, Thin Film, 34R8, 0.1%, ±25ppm, 1/4W, 1210	MC009479
Resistor, Thin Film, 12R4, 0.1%, ±25ppm, 1/4W, 1210	MC009439	Resistor, Thin Film, 35R7, 0.1%, ±25ppm, 1/4W, 1210	MC009480
Resistor, Thin Film, 12R7, 0.1%, ±25ppm, 1/4W, 1210	MC009440	Resistor, Thin Film, 36R5, 0.1%, ±25ppm, 1/4W, 1210	MC009481
Resistor, Thin Film, 13R, 0.1%, ±25ppm, 1/4W, 1210	MC009441	Resistor, Thin Film, 37R4, 0.1%, ±25ppm, 1/4W, 1210	MC009482
Resistor, Thin Film, 13R3, 0.1%, ±25ppm, 1/4W, 1210	MC009442	Resistor, Thin Film, 38R3, 0.1%, ±25ppm, 1/4W, 1210	MC009483
Resistor, Thin Film, 13R7, 0.1%, ±25ppm, 1/4W, 1210	MC009443	Resistor, Thin Film, 39R2, 0.1%, ±25ppm, 1/4W, 1210	MC009484
Resistor, Thin Film, 14R, 0.1%, ±25ppm, 1/4W, 1210	MC009444	Resistor, Thin Film, 40R2, 0.1%, ±25ppm, 1/4W, 1210	MC009485
Resistor, Thin Film, 14R3, 0.1%, ±25ppm, 1/4W, 1210	MC009445	Resistor, Thin Film, 41R2, 0.1%, ±25ppm, 1/4W, 1210	MC009486
Resistor, Thin Film, 14R7, 0.1%, ±25ppm, 1/4W, 1210	MC009446	Resistor, Thin Film, 42R2, 0.1%, ±25ppm, 1/4W, 1210	MC009487
Resistor, Thin Film, 15R, 0.1%, ±25ppm, 1/4W, 1210	MC009447	Resistor, Thin Film, 43R2, 0.1%, ±25ppm, 1/4W, 1210	MC009488
Resistor, Thin Film, 15R4, 0.1%, ±25ppm, 1/4W, 1210	MC009448	Resistor, Thin Film, 44R2, 0.1%, ±25ppm, 1/4W, 1210	MC009489
Resistor, Thin Film, 15R8, 0.1%, ±25ppm, 1/4W, 1210	MC009449	Resistor, Thin Film, 45R3, 0.1%, ±25ppm, 1/4W, 1210	MC009490
Resistor, Thin Film, 16R2, 0.1%, ±25ppm, 1/4W, 1210	MC009450	Resistor, Thin Film, 46R4, 0.1%, ±25ppm, 1/4W, 1210	MC009491
Resistor, Thin Film, 16R5, 0.1%, ±25ppm, 1/4W, 1210	MC009451	Resistor, Thin Film, 47R5, 0.1%, ±25ppm, 1/4W, 1210	MC009492
Resistor, Thin Film, 16R9, 0.1%, ±25ppm, 1/4W, 1210	MC009452	Resistor, Thin Film, 48R7, 0.1%, ±25ppm, 1/4W, 1210	MC009493
Resistor, Thin Film, 17R4, 0.1%, ±25ppm, 1/4W, 1210	MC009453	Resistor, Thin Film, 49R9, 0.1%, ±25ppm, 1/4W, 1210	MC009494
Resistor, Thin Film, 17R8, 0.1%, ±25ppm, 1/4W, 1210	MC009454	Resistor, Thin Film, 51R1, 0.1%, ±25ppm, 1/4W, 1210	MC009495
Resistor, Thin Film, 18R2, 0.1%, ±25ppm, 1/4W, 1210	MC009455	Resistor, Thin Film, 52R3, 0.1%, ±25ppm, 1/4W, 1210	MC009496
Resistor, Thin Film, 18R7, 0.1%, ±25ppm, 1/4W, 1210	MC009456	Resistor, Thin Film, 53R6, 0.1%, ±25ppm, 1/4W, 1210	MC009497
Resistor, Thin Film, 19R1, 0.1%, ±25ppm, 1/4W, 1210	MC009457	Resistor, Thin Film, 54R9, 0.1%, ±25ppm, 1/4W, 1210	MC009498
Resistor, Thin Film, 19R6, 0.1%, ±25ppm, 1/4W, 1210	MC009458	Resistor, Thin Film, 56R2, 0.1%, ±25ppm, 1/4W, 1210	MC009499
Resistor, Thin Film, 20R, 0.1%, ±25ppm, 1/4W, 1210	MC009459	Resistor, Thin Film, 57R6, 0.1%, ±25ppm, 1/4W, 1210	MC009500
Resistor, Thin Film, 20R5, 0.1%, ±25ppm, 1/4W, 1210	MC009460	Resistor, Thin Film, 59R, 0.1%, ±25ppm, 1/4W, 1210	MC009501

www.element14.com
www.farnell.com
www.newark.com



Thin Film Precision Chip Resistor

Description	Part Number	Description	Part Number
Resistor, Thin Film, 60R4, 0.1%, ±25ppm, 1/4W, 1210	MC009502	Resistor, Thin Film, 162R, 0.1%, ±25ppm, 1/4W, 1210	MC009543
Resistor, Thin Film, 61R9, 0.1%, ±25ppm, 1/4W, 1210	MC009503	Resistor, Thin Film, 165R, 0.1%, ±25ppm, 1/4W, 1210	MC009544
Resistor, Thin Film, 63R4, 0.1%, ±25ppm, 1/4W, 1210	MC009504	Resistor, Thin Film, 169R, 0.1%, ±25ppm, 1/4W, 1210	MC009545
Resistor, Thin Film, 64R9, 0.1%, ±25ppm, 1/4W, 1210	MC009505	Resistor, Thin Film, 174R, 0.1%, ±25ppm, 1/4W, 1210	MC009546
Resistor, Thin Film, 66R5, 0.1%, ±25ppm, 1/4W, 1210	MC009506	Resistor, Thin Film, 178R, 0.1%, ±25ppm, 1/4W, 1210	MC009547
Resistor, Thin Film, 68R1, 0.1%, ±25ppm, 1/4W, 1210	MC009507	Resistor, Thin Film, 182R, 0.1%, ±25ppm, 1/4W, 1210	MC009548
Resistor, Thin Film, 69R8, 0.1%, ±25ppm, 1/4W, 1210	MC009508	Resistor, Thin Film, 187R, 0.1%, ±25ppm, 1/4W, 1210	MC009549
Resistor, Thin Film, 71R5, 0.1%, ±25ppm, 1/4W, 1210	MC009509	Resistor, Thin Film, 191R, 0.1%, ±25ppm, 1/4W, 1210	MC009550
Resistor, Thin Film, 73R2, 0.1%, ±25ppm, 1/4W, 1210	MC009510	Resistor, Thin Film, 196R, 0.1%, ±25ppm, 1/4W, 1210	MC009551
Resistor, Thin Film, 75R, 0.1%, ±25ppm, 1/4W, 1210	MC009511	Resistor, Thin Film, 200R, 0.1%, ±25ppm, 1/4W, 1210	MC009552
Resistor, Thin Film, 76R8, 0.1%, ±25ppm, 1/4W, 1210	MC009512	Resistor, Thin Film, 205R, 0.1%, ±25ppm, 1/4W, 1210	MC009553
Resistor, Thin Film, 78R7, 0.1%, ±25ppm, 1/4W, 1210	MC009513	Resistor, Thin Film, 210R, 0.1%, ±25ppm, 1/4W, 1210	MC009554
Resistor, Thin Film, 80R6, 0.1%, ±25ppm, 1/4W, 1210	MC009514	Resistor, Thin Film, 215R, 0.1%, ±25ppm, 1/4W, 1210	MC009555
Resistor, Thin Film, 82R5, 0.1%, ±25ppm, 1/4W, 1210	MC009515	Resistor, Thin Film, 221R, 0.1%, ±25ppm, 1/4W, 1210	MC009556
Resistor, Thin Film, 84R5, 0.1%, ±25ppm, 1/4W, 1210	MC009516	Resistor, Thin Film, 226R, 0.1%, ±25ppm, 1/4W, 1210	MC009557
Resistor, Thin Film, 86R6, 0.1%, ±25ppm, 1/4W, 1210	MC009517	Resistor, Thin Film, 232R, 0.1%, ±25ppm, 1/4W, 1210	MC009558
Resistor, Thin Film, 88R7, 0.1%, ±25ppm, 1/4W, 1210	MC009518	Resistor, Thin Film, 237R, 0.1%, ±25ppm, 1/4W, 1210	MC009559
Resistor, Thin Film, 90R9, 0.1%, ±25ppm, 1/4W, 1210	MC009519	Resistor, Thin Film, 243R, 0.1%, ±25ppm, 1/4W, 1210	MC009560
Resistor, Thin Film, 93R1, 0.1%, ±25ppm, 1/4W, 1210	MC009520	Resistor, Thin Film, 249R, 0.1%, ±25ppm, 1/4W, 1210	MC009561
Resistor, Thin Film, 95R3, 0.1%, ±25ppm, 1/4W, 1210	MC009521	Resistor, Thin Film, 255R, 0.1%, ±25ppm, 1/4W, 1210	MC009562
Resistor, Thin Film, 97R6, 0.1%, ±25ppm, 1/4W, 1210	MC009522	Resistor, Thin Film, 261R, 0.1%, ±25ppm, 1/4W, 1210	MC009563
Resistor, Thin Film, 100R, 0.1%, ±25ppm, 1/4W, 1210	MC009523	Resistor, Thin Film, 267R, 0.1%, ±25ppm, 1/4W, 1210	MC009564
Resistor, Thin Film, 102R, 0.1%, ±25ppm, 1/4W, 1210	MC009524	Resistor, Thin Film, 274R, 0.1%, ±25ppm, 1/4W, 1210	MC009565
Resistor, Thin Film, 105R, 0.1%, ±25ppm, 1/4W, 1210	MC009525	Resistor, Thin Film, 280R, 0.1%, ±25ppm, 1/4W, 1210	MC009566
Resistor, Thin Film, 107R, 0.1%, ±25ppm, 1/4W, 1210	MC009526	Resistor, Thin Film, 294R, 0.1%, ±25ppm, 1/4W, 1210	MC009567
Resistor, Thin Film, 110R, 0.1%, ±25ppm, 1/4W, 1210	MC009527	Resistor, Thin Film, 316R, 0.1%, ±25ppm, 1/4W, 1210	MC009568
Resistor, Thin Film, 113R, 0.1%, ±25ppm, 1/4W, 1210	MC009528	Resistor, Thin Film, 324R, 0.1%, ±25ppm, 1/4W, 1210	MC009569
Resistor, Thin Film, 115R, 0.1%, ±25ppm, 1/4W, 1210	MC009529	Resistor, Thin Film, 332R, 0.1%, ±25ppm, 1/4W, 1210	MC009570
Resistor, Thin Film, 118R, 0.1%, ±25ppm, 1/4W, 1210	MC009530	Resistor, Thin Film, 340R, 0.1%, ±25ppm, 1/4W, 1210	MC009571
Resistor, Thin Film, 121R, 0.1%, ±25ppm, 1/4W, 1210	MC009531	Resistor, Thin Film, 348R, 0.1%, ±25ppm, 1/4W, 1210	MC009572
Resistor, Thin Film, 124R, 0.1%, ±25ppm, 1/4W, 1210	MC009532	Resistor, Thin Film, 357R, 0.1%, ±25ppm, 1/4W, 1210	MC009573
Resistor, Thin Film, 127R, 0.1%, ±25ppm, 1/4W, 1210	MC009533	Resistor, Thin Film, 365R, 0.1%, ±25ppm, 1/4W, 1210	MC009574
Resistor, Thin Film, 130R, 0.1%, ±25ppm, 1/4W, 1210	MC009534	Resistor, Thin Film, 374R, 0.1%, ±25ppm, 1/4W, 1210	MC009575
Resistor, Thin Film, 133R, 0.1%, ±25ppm, 1/4W, 1210	MC009535	Resistor, Thin Film, 383R, 0.1%, ±25ppm, 1/4W, 1210	MC009576
Resistor, Thin Film, 137R, 0.1%, ±25ppm, 1/4W, 1210	MC009536	Resistor, Thin Film, 392R, 0.1%, ±25ppm, 1/4W, 1210	MC009577
Resistor, Thin Film, 140R, 0.1%, ±25ppm, 1/4W, 1210	MC009537	Resistor, Thin Film, 402R, 0.1%, ±25ppm, 1/4W, 1210	MC009578
Resistor, Thin Film, 143R, 0.1%, ±25ppm, 1/4W, 1210	MC009538	Resistor, Thin Film, 412R, 0.1%, ±25ppm, 1/4W, 1210	MC009579
Resistor, Thin Film, 147R, 0.1%, ±25ppm, 1/4W, 1210	MC009539	Resistor, Thin Film, 422R, 0.1%, ±25ppm, 1/4W, 1210	MC009580
Resistor, Thin Film, 150R, 0.1%, ±25ppm, 1/4W, 1210	MC009540	Resistor, Thin Film, 432R, 0.1%, ±25ppm, 1/4W, 1210	MC009581
Resistor, Thin Film, 154R, 0.1%, ±25ppm, 1/4W, 1210	MC009541	Resistor, Thin Film, 442R, 0.1%, ±25ppm, 1/4W, 1210	MC009582
Resistor, Thin Film, 158R, 0.1%, ±25ppm, 1/4W, 1210	MC009542	Resistor, Thin Film, 453R, 0.1%, ±25ppm, 1/4W, 1210	MC009583

www.element14.com
www.farnell.com
www.newark.com



Thin Film Precision Chip Resistor

Description	Part Number	Description	Part Number
Resistor, Thin Film, 464R, 0.1%, ±25ppm, 1/4W, 1210	MC009584	Resistor, Thin Film, 1K24, 0.1%, ±25ppm, 1/4W, 1210	MC009625
Resistor, Thin Film, 475R, 0.1%, ±25ppm, 1/4W, 1210	MC009585	Resistor, Thin Film, 1K27, 0.1%, ±25ppm, 1/4W, 1210	MC009626
Resistor, Thin Film, 487R, 0.1%, ±25ppm, 1/4W, 1210	MC009586	Resistor, Thin Film, 1K3, 0.1%, ±25ppm, 1/4W, 1210	MC009627
Resistor, Thin Film, 499R, 0.1%, ±25ppm, 1/4W, 1210	MC009587	Resistor, Thin Film, 1K33, 0.1%, ±25ppm, 1/4W, 1210	MC009628
Resistor, Thin Film, 511R, 0.1%, ±25ppm, 1/4W, 1210	MC009588	Resistor, Thin Film, 1K37, 0.1%, ±25ppm, 1/4W, 1210	MC009629
Resistor, Thin Film, 523R, 0.1%, ±25ppm, 1/4W, 1210	MC009589	Resistor, Thin Film, 1K4, 0.1%, ±25ppm, 1/4W, 1210	MC009630
Resistor, Thin Film, 536R, 0.1%, ±25ppm, 1/4W, 1210	MC009590	Resistor, Thin Film, 1K43, 0.1%, ±25ppm, 1/4W, 1210	MC009631
Resistor, Thin Film, 549R, 0.1%, ±25ppm, 1/4W, 1210	MC009591	Resistor, Thin Film, 1K47, 0.1%, ±25ppm, 1/4W, 1210	MC009632
Resistor, Thin Film, 562R, 0.1%, ±25ppm, 1/4W, 1210	MC009592	Resistor, Thin Film, 1K5, 0.1%, ±25ppm, 1/4W, 1210	MC009633
Resistor, Thin Film, 576R, 0.1%, ±25ppm, 1/4W, 1210	MC009593	Resistor, Thin Film, 1K54, 0.1%, ±25ppm, 1/4W, 1210	MC009634
Resistor, Thin Film, 590R, 0.1%, ±25ppm, 1/4W, 1210	MC009594	Resistor, Thin Film, 1K58, 0.1%, ±25ppm, 1/4W, 1210	MC009635
Resistor, Thin Film, 604R, 0.1%, ±25ppm, 1/4W, 1210	MC009595	Resistor, Thin Film, 1K62, 0.1%, ±25ppm, 1/4W, 1210	MC009636
Resistor, Thin Film, 619R, 0.1%, ±25ppm, 1/4W, 1210	MC009596	Resistor, Thin Film, 1K65, 0.1%, ±25ppm, 1/4W, 1210	MC009637
Resistor, Thin Film, 634R, 0.1%, ±25ppm, 1/4W, 1210	MC009597	Resistor, Thin Film, 1K69, 0.1%, ±25ppm, 1/4W, 1210	MC009638
Resistor, Thin Film, 649R, 0.1%, ±25ppm, 1/4W, 1210	MC009598	Resistor, Thin Film, 1K74, 0.1%, ±25ppm, 1/4W, 1210	MC009639
Resistor, Thin Film, 665R, 0.1%, ±25ppm, 1/4W, 1210	MC009599	Resistor, Thin Film, 1K78, 0.1%, ±25ppm, 1/4W, 1210	MC009640
Resistor, Thin Film, 681R, 0.1%, ±25ppm, 1/4W, 1210	MC009600	Resistor, Thin Film, 1K82, 0.1%, ±25ppm, 1/4W, 1210	MC009641
Resistor, Thin Film, 698R, 0.1%, ±25ppm, 1/4W, 1210	MC009601	Resistor, Thin Film, 1K87, 0.1%, ±25ppm, 1/4W, 1210	MC009642
Resistor, Thin Film, 715R, 0.1%, ±25ppm, 1/4W, 1210	MC009602	Resistor, Thin Film, 1K91, 0.1%, ±25ppm, 1/4W, 1210	MC009643
Resistor, Thin Film, 732R, 0.1%, ±25ppm, 1/4W, 1210	MC009603	Resistor, Thin Film, 1K96, 0.1%, ±25ppm, 1/4W, 1210	MC009644
Resistor, Thin Film, 750R, 0.1%, ±25ppm, 1/4W, 1210	MC009604	Resistor, Thin Film, 2K, 0.1%, ±25ppm, 1/4W, 1210	MC009645
Resistor, Thin Film, 768R, 0.1%, ±25ppm, 1/4W, 1210	MC009605	Resistor, Thin Film, 2K05, 0.1%, ±25ppm, 1/4W, 1210	MC009646
Resistor, Thin Film, 787R, 0.1%, ±25ppm, 1/4W, 1210	MC009606	Resistor, Thin Film, 2K1, 0.1%, ±25ppm, 1/4W, 1210	MC009647
Resistor, Thin Film, 806R, 0.1%, ±25ppm, 1/4W, 1210	MC009607	Resistor, Thin Film, 2K15, 0.1%, ±25ppm, 1/4W, 1210	MC009648
Resistor, Thin Film, 825R, 0.1%, ±25ppm, 1/4W, 1210	MC009608	Resistor, Thin Film, 2K21, 0.1%, ±25ppm, 1/4W, 1210	MC009649
Resistor, Thin Film, 845R, 0.1%, ±25ppm, 1/4W, 1210	MC009609	Resistor, Thin Film, 2K26, 0.1%, ±25ppm, 1/4W, 1210	MC009650
Resistor, Thin Film, 866R, 0.1%, ±25ppm, 1/4W, 1210	MC009610	Resistor, Thin Film, 2K32, 0.1%, ±25ppm, 1/4W, 1210	MC009651
Resistor, Thin Film, 887R, 0.1%, ±25ppm, 1/4W, 1210	MC009611	Resistor, Thin Film, 2K37, 0.1%, ±25ppm, 1/4W, 1210	MC009652
Resistor, Thin Film, 909R, 0.1%, ±25ppm, 1/4W, 1210	MC009612	Resistor, Thin Film, 2K43, 0.1%, ±25ppm, 1/4W, 1210	MC009653
Resistor, Thin Film, 931R, 0.1%, ±25ppm, 1/4W, 1210	MC009613	Resistor, Thin Film, 2K49, 0.1%, ±25ppm, 1/4W, 1210	MC009654
Resistor, Thin Film, 953R, 0.1%, ±25ppm, 1/4W, 1210	MC009614	Resistor, Thin Film, 2K55, 0.1%, ±25ppm, 1/4W, 1210	MC009655
Resistor, Thin Film, 976R, 0.1%, ±25ppm, 1/4W, 1210	MC009615	Resistor, Thin Film, 2K61, 0.1%, ±25ppm, 1/4W, 1210	MC009656
Resistor, Thin Film, 1K, 0.1%, ±25ppm, 1/4W, 1210	MC009616	Resistor, Thin Film, 2K67, 0.1%, ±25ppm, 1/4W, 1210	MC009657
Resistor, Thin Film, 1K02, 0.1%, ±25ppm, 1/4W, 1210	MC009617	Resistor, Thin Film, 2K74, 0.1%, ±25ppm, 1/4W, 1210	MC009658
Resistor, Thin Film, 1K05, 0.1%, ±25ppm, 1/4W, 1210	MC009618	Resistor, Thin Film, 2K8, 0.1%, ±25ppm, 1/4W, 1210	MC009659
Resistor, Thin Film, 1K07, 0.1%, ±25ppm, 1/4W, 1210	MC009619	Resistor, Thin Film, 2K94, 0.1%, ±25ppm, 1/4W, 1210	MC009660
Resistor, Thin Film, 1K1, 0.1%, ±25ppm, 1/4W, 1210	MC009620	Resistor, Thin Film, 3K16, 0.1%, ±25ppm, 1/4W, 1210	MC009661
Resistor, Thin Film, 1K13, 0.1%, ±25ppm, 1/4W, 1210	MC009621	Resistor, Thin Film, 3K24, 0.1%, ±25ppm, 1/4W, 1210	MC009662
Resistor, Thin Film, 1K15, 0.1%, ±25ppm, 1/4W, 1210	MC009622	Resistor, Thin Film, 3K32, 0.1%, ±25ppm, 1/4W, 1210	MC009663
Resistor, Thin Film, 1K18, 0.1%, ±25ppm, 1/4W, 1210	MC009623	Resistor, Thin Film, 3K4, 0.1%, ±25ppm, 1/4W, 1210	MC009664
Resistor, Thin Film, 1K21, 0.1%, ±25ppm, 1/4W, 1210	MC009624	Resistor, Thin Film, 3K48, 0.1%, ±25ppm, 1/4W, 1210	MC009665

www.element14.com
www.farnell.com
www.newark.com



Thin Film Precision Chip Resistor

Description	Part Number	Description	Part Number
Resistor, Thin Film, 3K57, 0.1%, ±25ppm, 1/4W, 1210	MC009666	Resistor, Thin Film, 9K53, 0.1%, ±25ppm, 1/4W, 1210	MC009707
Resistor, Thin Film, 3K65, 0.1%, ±25ppm, 1/4W, 1210	MC009667	Resistor, Thin Film, 9K76, 0.1%, ±25ppm, 1/4W, 1210	MC009708
Resistor, Thin Film, 3K74, 0.1%, ±25ppm, 1/4W, 1210	MC009668	Resistor, Thin Film, 10K, 0.1%, ±25ppm, 1/4W, 1210	MC009709
Resistor, Thin Film, 3K83, 0.1%, ±25ppm, 1/4W, 1210	MC009669	Resistor, Thin Film, 10K2, 0.1%, ±25ppm, 1/4W, 1210	MC009710
Resistor, Thin Film, 3K92, 0.1%, ±25ppm, 1/4W, 1210	MC009670	Resistor, Thin Film, 10K5, 0.1%, ±25ppm, 1/4W, 1210	MC009711
Resistor, Thin Film, 4K02, 0.1%, ±25ppm, 1/4W, 1210	MC009671	Resistor, Thin Film, 10K7, 0.1%, ±25ppm, 1/4W, 1210	MC009712
Resistor, Thin Film, 4K12, 0.1%, ±25ppm, 1/4W, 1210	MC009672	Resistor, Thin Film, 11K, 0.1%, ±25ppm, 1/4W, 1210	MC009713
Resistor, Thin Film, 4K22, 0.1%, ±25ppm, 1/4W, 1210	MC009673	Resistor, Thin Film, 11K3, 0.1%, ±25ppm, 1/4W, 1210	MC009714
Resistor, Thin Film, 4K32, 0.1%, ±25ppm, 1/4W, 1210	MC009674	Resistor, Thin Film, 11K5, 0.1%, ±25ppm, 1/4W, 1210	MC009715
Resistor, Thin Film, 4K42, 0.1%, ±25ppm, 1/4W, 1210	MC009675	Resistor, Thin Film, 11K8, 0.1%, ±25ppm, 1/4W, 1210	MC009716
Resistor, Thin Film, 4K53, 0.1%, ±25ppm, 1/4W, 1210	MC009676	Resistor, Thin Film, 12K1, 0.1%, ±25ppm, 1/4W, 1210	MC009717
Resistor, Thin Film, 4K64, 0.1%, ±25ppm, 1/4W, 1210	MC009677	Resistor, Thin Film, 12K4, 0.1%, ±25ppm, 1/4W, 1210	MC009718
Resistor, Thin Film, 4K75, 0.1%, ±25ppm, 1/4W, 1210	MC009678	Resistor, Thin Film, 12K7, 0.1%, ±25ppm, 1/4W, 1210	MC009719
Resistor, Thin Film, 4K87, 0.1%, ±25ppm, 1/4W, 1210	MC009679	Resistor, Thin Film, 13K, 0.1%, ±25ppm, 1/4W, 1210	MC009720
Resistor, Thin Film, 4K99, 0.1%, ±25ppm, 1/4W, 1210	MC009680	Resistor, Thin Film, 13K3, 0.1%, ±25ppm, 1/4W, 1210	MC009721
Resistor, Thin Film, 5K11, 0.1%, ±25ppm, 1/4W, 1210	MC009681	Resistor, Thin Film, 13K7, 0.1%, ±25ppm, 1/4W, 1210	MC009722
Resistor, Thin Film, 5K23, 0.1%, ±25ppm, 1/4W, 1210	MC009682	Resistor, Thin Film, 14K, 0.1%, ±25ppm, 1/4W, 1210	MC009723
Resistor, Thin Film, 5K36, 0.1%, ±25ppm, 1/4W, 1210	MC009683	Resistor, Thin Film, 14K3, 0.1%, ±25ppm, 1/4W, 1210	MC009724
Resistor, Thin Film, 5K49, 0.1%, ±25ppm, 1/4W, 1210	MC009684	Resistor, Thin Film, 14K7, 0.1%, ±25ppm, 1/4W, 1210	MC009725
Resistor, Thin Film, 5K62, 0.1%, ±25ppm, 1/4W, 1210	MC009685	Resistor, Thin Film, 15K, 0.1%, ±25ppm, 1/4W, 1210	MC009726
Resistor, Thin Film, 5K76, 0.1%, ±25ppm, 1/4W, 1210	MC009686	Resistor, Thin Film, 15K4, 0.1%, ±25ppm, 1/4W, 1210	MC009727
Resistor, Thin Film, 5K9, 0.1%, ±25ppm, 1/4W, 1210	MC009687	Resistor, Thin Film, 15K8, 0.1%, ±25ppm, 1/4W, 1210	MC009728
Resistor, Thin Film, 6K04, 0.1%, ±25ppm, 1/4W, 1210	MC009688	Resistor, Thin Film, 16K2, 0.1%, ±25ppm, 1/4W, 1210	MC009729
Resistor, Thin Film, 6K19, 0.1%, ±25ppm, 1/4W, 1210	MC009689	Resistor, Thin Film, 16K5, 0.1%, ±25ppm, 1/4W, 1210	MC009730
Resistor, Thin Film, 6K34, 0.1%, ±25ppm, 1/4W, 1210	MC009690	Resistor, Thin Film, 16K9, 0.1%, ±25ppm, 1/4W, 1210	MC009731
Resistor, Thin Film, 6K49, 0.1%, ±25ppm, 1/4W, 1210	MC009691	Resistor, Thin Film, 17K4, 0.1%, ±25ppm, 1/4W, 1210	MC009732
Resistor, Thin Film, 6K65, 0.1%, ±25ppm, 1/4W, 1210	MC009692	Resistor, Thin Film, 17K8, 0.1%, ±25ppm, 1/4W, 1210	MC009733
Resistor, Thin Film, 6K81, 0.1%, ±25ppm, 1/4W, 1210	MC009693	Resistor, Thin Film, 18K2, 0.1%, ±25ppm, 1/4W, 1210	MC009734
Resistor, Thin Film, 6K98, 0.1%, ±25ppm, 1/4W, 1210	MC009694	Resistor, Thin Film, 18K7, 0.1%, ±25ppm, 1/4W, 1210	MC009735
Resistor, Thin Film, 7K15, 0.1%, ±25ppm, 1/4W, 1210	MC009695	Resistor, Thin Film, 19K1, 0.1%, ±25ppm, 1/4W, 1210	MC009736
Resistor, Thin Film, 7K32, 0.1%, ±25ppm, 1/4W, 1210	MC009696	Resistor, Thin Film, 19K6, 0.1%, ±25ppm, 1/4W, 1210	MC009737
Resistor, Thin Film, 7K5, 0.1%, ±25ppm, 1/4W, 1210	MC009697	Resistor, Thin Film, 20K, 0.1%, ±25ppm, 1/4W, 1210	MC009738
Resistor, Thin Film, 7K68, 0.1%, ±25ppm, 1/4W, 1210	MC009698	Resistor, Thin Film, 20K5, 0.1%, ±25ppm, 1/4W, 1210	MC009739
Resistor, Thin Film, 7K87, 0.1%, ±25ppm, 1/4W, 1210	MC009699	Resistor, Thin Film, 21K, 0.1%, ±25ppm, 1/4W, 1210	MC009740
Resistor, Thin Film, 8K06, 0.1%, ±25ppm, 1/4W, 1210	MC009700	Resistor, Thin Film, 21K5, 0.1%, ±25ppm, 1/4W, 1210	MC009741
Resistor, Thin Film, 8K25, 0.1%, ±25ppm, 1/4W, 1210	MC009701	Resistor, Thin Film, 22K1, 0.1%, ±25ppm, 1/4W, 1210	MC009742
Resistor, Thin Film, 8K45, 0.1%, ±25ppm, 1/4W, 1210	MC009702	Resistor, Thin Film, 22K6, 0.1%, ±25ppm, 1/4W, 1210	MC009743
Resistor, Thin Film, 8K66, 0.1%, ±25ppm, 1/4W, 1210	MC009703	Resistor, Thin Film, 23K2, 0.1%, ±25ppm, 1/4W, 1210	MC009744
Resistor, Thin Film, 8K87, 0.1%, ±25ppm, 1/4W, 1210	MC009704	Resistor, Thin Film, 23K7, 0.1%, ±25ppm, 1/4W, 1210	MC009745
Resistor, Thin Film, 9K09, 0.1%, ±25ppm, 1/4W, 1210	MC009705	Resistor, Thin Film, 24K3, 0.1%, ±25ppm, 1/4W, 1210	MC009746
Resistor, Thin Film, 9K31, 0.1%, ±25ppm, 1/4W, 1210	MC009706	Resistor, Thin Film, 24K9, 0.1%, ±25ppm, 1/4W, 1210	MC009747

www.element14.com
www.farnell.com
www.newark.com



Thin Film Precision Chip Resistor

Description	Part Number	Description	Part Number
Resistor, Thin Film, 25K5, 0.1%, ±25ppm, 1/4W, 1210	MC009748	Resistor, Thin Film, 73K2, 0.1%, ±25ppm, 1/4W, 1210	MC009789
Resistor, Thin Film, 26K1, 0.1%, ±25ppm, 1/4W, 1210	MC009749	Resistor, Thin Film, 75K, 0.1%, ±25ppm, 1/4W, 1210	MC009790
Resistor, Thin Film, 26K7, 0.1%, ±25ppm, 1/4W, 1210	MC009750	Resistor, Thin Film, 76K8, 0.1%, ±25ppm, 1/4W, 1210	MC009791
Resistor, Thin Film, 27K4, 0.1%, ±25ppm, 1/4W, 1210	MC009751	Resistor, Thin Film, 78K7, 0.1%, ±25ppm, 1/4W, 1210	MC009792
Resistor, Thin Film, 28K, 0.1%, ±25ppm, 1/4W, 1210	MC009752	Resistor, Thin Film, 80K6, 0.1%, ±25ppm, 1/4W, 1210	MC009793
Resistor, Thin Film, 29K4, 0.1%, ±25ppm, 1/4W, 1210	MC009753	Resistor, Thin Film, 82K5, 0.1%, ±25ppm, 1/4W, 1210	MC009794
Resistor, Thin Film, 31K6, 0.1%, ±25ppm, 1/4W, 1210	MC009754	Resistor, Thin Film, 84K5, 0.1%, ±25ppm, 1/4W, 1210	MC009795
Resistor, Thin Film, 32K4, 0.1%, ±25ppm, 1/4W, 1210	MC009755	Resistor, Thin Film, 86K6, 0.1%, ±25ppm, 1/4W, 1210	MC009796
Resistor, Thin Film, 33K2, 0.1%, ±25ppm, 1/4W, 1210	MC009756	Resistor, Thin Film, 88K7, 0.1%, ±25ppm, 1/4W, 1210	MC009797
Resistor, Thin Film, 34K, 0.1%, ±25ppm, 1/4W, 1210	MC009757	Resistor, Thin Film, 90K9, 0.1%, ±25ppm, 1/4W, 1210	MC009798
Resistor, Thin Film, 34K8, 0.1%, ±25ppm, 1/4W, 1210	MC009758	Resistor, Thin Film, 93K1, 0.1%, ±25ppm, 1/4W, 1210	MC009799
Resistor, Thin Film, 35K7, 0.1%, ±25ppm, 1/4W, 1210	MC009759	Resistor, Thin Film, 95K3, 0.1%, ±25ppm, 1/4W, 1210	MC009800
Resistor, Thin Film, 36K5, 0.1%, ±25ppm, 1/4W, 1210	MC009760	Resistor, Thin Film, 97K6, 0.1%, ±25ppm, 1/4W, 1210	MC009801
Resistor, Thin Film, 37K4, 0.1%, ±25ppm, 1/4W, 1210	MC009761	Resistor, Thin Film, 100K, 0.1%, ±25ppm, 1/4W, 1210	MC009802
Resistor, Thin Film, 38K3, 0.1%, ±25ppm, 1/4W, 1210	MC009762	Resistor, Thin Film, 102K, 0.1%, ±25ppm, 1/4W, 1210	MC009803
Resistor, Thin Film, 39K2, 0.1%, ±25ppm, 1/4W, 1210	MC009763	Resistor, Thin Film, 105K, 0.1%, ±25ppm, 1/4W, 1210	MC009804
Resistor, Thin Film, 40K2, 0.1%, ±25ppm, 1/4W, 1210	MC009764	Resistor, Thin Film, 107K, 0.1%, ±25ppm, 1/4W, 1210	MC009805
Resistor, Thin Film, 41K2, 0.1%, ±25ppm, 1/4W, 1210	MC009765	Resistor, Thin Film, 110K, 0.1%, ±25ppm, 1/4W, 1210	MC009806
Resistor, Thin Film, 42K2, 0.1%, ±25ppm, 1/4W, 1210	MC009766	Resistor, Thin Film, 113K, 0.1%, ±25ppm, 1/4W, 1210	MC009807
Resistor, Thin Film, 43K2, 0.1%, ±25ppm, 1/4W, 1210	MC009767	Resistor, Thin Film, 115K, 0.1%, ±25ppm, 1/4W, 1210	MC009808
Resistor, Thin Film, 44K2, 0.1%, ±25ppm, 1/4W, 1210	MC009768	Resistor, Thin Film, 118K, 0.1%, ±25ppm, 1/4W, 1210	MC009809
Resistor, Thin Film, 45K3, 0.1%, ±25ppm, 1/4W, 1210	MC009769	Resistor, Thin Film, 121K, 0.1%, ±25ppm, 1/4W, 1210	MC009810
Resistor, Thin Film, 46K4, 0.1%, ±25ppm, 1/4W, 1210	MC009770	Resistor, Thin Film, 124K, 0.1%, ±25ppm, 1/4W, 1210	MC009811
Resistor, Thin Film, 47K5, 0.1%, ±25ppm, 1/4W, 1210	MC009771	Resistor, Thin Film, 127K, 0.1%, ±25ppm, 1/4W, 1210	MC009812
Resistor, Thin Film, 48K7, 0.1%, ±25ppm, 1/4W, 1210	MC009772	Resistor, Thin Film, 130K, 0.1%, ±25ppm, 1/4W, 1210	MC009813
Resistor, Thin Film, 49K9, 0.1%, ±25ppm, 1/4W, 1210	MC009773	Resistor, Thin Film, 133K, 0.1%, ±25ppm, 1/4W, 1210	MC009814
Resistor, Thin Film, 51K1, 0.1%, ±25ppm, 1/4W, 1210	MC009774	Resistor, Thin Film, 137K, 0.1%, ±25ppm, 1/4W, 1210	MC009815
Resistor, Thin Film, 52K3, 0.1%, ±25ppm, 1/4W, 1210	MC009775	Resistor, Thin Film, 140K, 0.1%, ±25ppm, 1/4W, 1210	MC009816
Resistor, Thin Film, 53K6, 0.1%, ±25ppm, 1/4W, 1210	MC009776	Resistor, Thin Film, 143K, 0.1%, ±25ppm, 1/4W, 1210	MC009817
Resistor, Thin Film, 54K9, 0.1%, ±25ppm, 1/4W, 1210	MC009777	Resistor, Thin Film, 147K, 0.1%, ±25ppm, 1/4W, 1210	MC009818
Resistor, Thin Film, 56K2, 0.1%, ±25ppm, 1/4W, 1210	MC009778	Resistor, Thin Film, 150K, 0.1%, ±25ppm, 1/4W, 1210	MC009819
Resistor, Thin Film, 57K6, 0.1%, ±25ppm, 1/4W, 1210	MC009779	Resistor, Thin Film, 154K, 0.1%, ±25ppm, 1/4W, 1210	MC009820
Resistor, Thin Film, 59K, 0.1%, ±25ppm, 1/4W, 1210	MC009780	Resistor, Thin Film, 158K, 0.1%, ±25ppm, 1/4W, 1210	MC009821
Resistor, Thin Film, 60K4, 0.1%, ±25ppm, 1/4W, 1210	MC009781	Resistor, Thin Film, 162K, 0.1%, ±25ppm, 1/4W, 1210	MC009822
Resistor, Thin Film, 61K9, 0.1%, ±25ppm, 1/4W, 1210	MC009782	Resistor, Thin Film, 165K, 0.1%, ±25ppm, 1/4W, 1210	MC009823
Resistor, Thin Film, 63K4, 0.1%, ±25ppm, 1/4W, 1210	MC009783	Resistor, Thin Film, 169K, 0.1%, ±25ppm, 1/4W, 1210	MC009824
Resistor, Thin Film, 64K9, 0.1%, ±25ppm, 1/4W, 1210	MC009784	Resistor, Thin Film, 174K, 0.1%, ±25ppm, 1/4W, 1210	MC009825
Resistor, Thin Film, 66K5, 0.1%, ±25ppm, 1/4W, 1210	MC009785	Resistor, Thin Film, 178K, 0.1%, ±25ppm, 1/4W, 1210	MC009826
Resistor, Thin Film, 68K1, 0.1%, ±25ppm, 1/4W, 1210	MC009786	Resistor, Thin Film, 182K, 0.1%, ±25ppm, 1/4W, 1210	MC009827
Resistor, Thin Film, 69K8, 0.1%, ±25ppm, 1/4W, 1210	MC009787	Resistor, Thin Film, 187K, 0.1%, ±25ppm, 1/4W, 1210	MC009828
Resistor, Thin Film, 71K5, 0.1%, ±25ppm, 1/4W, 1210	MC009788	Resistor, Thin Film, 191K, 0.1%, ±25ppm, 1/4W, 1210	MC009829

www.element14.com
www.farnell.com
www.newark.com



Thin Film Precision Chip Resistor

Description	Part Number	Description	Part Number
Resistor, Thin Film, 196K, 0.1%, ±25ppm, 1/4W, 1210	MC009830	Resistor, Thin Film, 562K, 0.1%, ±25ppm, 1/4W, 1210	MC009871
Resistor, Thin Film, 200K, 0.1%, ±25ppm, 1/4W, 1210	MC009831	Resistor, Thin Film, 576K, 0.1%, ±25ppm, 1/4W, 1210	MC009872
Resistor, Thin Film, 205K, 0.1%, ±25ppm, 1/4W, 1210	MC009832	Resistor, Thin Film, 590K, 0.1%, ±25ppm, 1/4W, 1210	MC009873
Resistor, Thin Film, 210K, 0.1%, ±25ppm, 1/4W, 1210	MC009833	Resistor, Thin Film, 604K, 0.1%, ±25ppm, 1/4W, 1210	MC009874
Resistor, Thin Film, 215K, 0.1%, ±25ppm, 1/4W, 1210	MC009834	Resistor, Thin Film, 619K, 0.1%, ±25ppm, 1/4W, 1210	MC009875
Resistor, Thin Film, 221K, 0.1%, ±25ppm, 1/4W, 1210	MC009835	Resistor, Thin Film, 634K, 0.1%, ±25ppm, 1/4W, 1210	MC009876
Resistor, Thin Film, 226K, 0.1%, ±25ppm, 1/4W, 1210	MC009836	Resistor, Thin Film, 649K, 0.1%, ±25ppm, 1/4W, 1210	MC009877
Resistor, Thin Film, 232K, 0.1%, ±25ppm, 1/4W, 1210	MC009837	Resistor, Thin Film, 665K, 0.1%, ±25ppm, 1/4W, 1210	MC009878
Resistor, Thin Film, 237K, 0.1%, ±25ppm, 1/4W, 1210	MC009838	Resistor, Thin Film, 681K, 0.1%, ±25ppm, 1/4W, 1210	MC009879
Resistor, Thin Film, 243K, 0.1%, ±25ppm, 1/4W, 1210	MC009839	Resistor, Thin Film, 698K, 0.1%, ±25ppm, 1/4W, 1210	MC009880
Resistor, Thin Film, 249K, 0.1%, ±25ppm, 1/4W, 1210	MC009840	Resistor, Thin Film, 715K, 0.1%, ±25ppm, 1/4W, 1210	MC009881
Resistor, Thin Film, 255K, 0.1%, ±25ppm, 1/4W, 1210	MC009841	Resistor, Thin Film, 732K, 0.1%, ±25ppm, 1/4W, 1210	MC009882
Resistor, Thin Film, 261K, 0.1%, ±25ppm, 1/4W, 1210	MC009842	Resistor, Thin Film, 750K, 0.1%, ±25ppm, 1/4W, 1210	MC009883
Resistor, Thin Film, 267K, 0.1%, ±25ppm, 1/4W, 1210	MC009843	Resistor, Thin Film, 768K, 0.1%, ±25ppm, 1/4W, 1210	MC009884
Resistor, Thin Film, 274K, 0.1%, ±25ppm, 1/4W, 1210	MC009844	Resistor, Thin Film, 787K, 0.1%, ±25ppm, 1/4W, 1210	MC009885
Resistor, Thin Film, 280K, 0.1%, ±25ppm, 1/4W, 1210	MC009845	Resistor, Thin Film, 806K, 0.1%, ±25ppm, 1/4W, 1210	MC009886
Resistor, Thin Film, 294K, 0.1%, ±25ppm, 1/4W, 1210	MC009846	Resistor, Thin Film, 825K, 0.1%, ±25ppm, 1/4W, 1210	MC009887
Resistor, Thin Film, 316K, 0.1%, ±25ppm, 1/4W, 1210	MC009847	Resistor, Thin Film, 845K, 0.1%, ±25ppm, 1/4W, 1210	MC009888
Resistor, Thin Film, 324K, 0.1%, ±25ppm, 1/4W, 1210	MC009848	Resistor, Thin Film, 866K, 0.1%, ±25ppm, 1/4W, 1210	MC009889
Resistor, Thin Film, 332K, 0.1%, ±25ppm, 1/4W, 1210	MC009849	Resistor, Thin Film, 887K, 0.1%, ±25ppm, 1/4W, 1210	MC009890
Resistor, Thin Film, 340K, 0.1%, ±25ppm, 1/4W, 1210	MC009850	Resistor, Thin Film, 909K, 0.1%, ±25ppm, 1/4W, 1210	MC009891
Resistor, Thin Film, 348K, 0.1%, ±25ppm, 1/4W, 1210	MC009851	Resistor, Thin Film, 931K, 0.1%, ±25ppm, 1/4W, 1210	MC009892
Resistor, Thin Film, 357K, 0.1%, ±25ppm, 1/4W, 1210	MC009852	Resistor, Thin Film, 953K, 0.1%, ±25ppm, 1/4W, 1210	MC009893
Resistor, Thin Film, 365K, 0.1%, ±25ppm, 1/4W, 1210	MC009853	Resistor, Thin Film, 976K, 0.1%, ±25ppm, 1/4W, 1210	MC009894
Resistor, Thin Film, 374K, 0.1%, ±25ppm, 1/4W, 1210	MC009854	Resistor, Thin Film, 1M, 0.1%, ±25ppm, 1/4W, 1210	MC009895
Resistor, Thin Film, 383K, 0.1%, ±25ppm, 1/4W, 1210	MC009855	Resistor, Thin Film, 1M1, 0.1%, ±25ppm, 1/4W, 1210	MC009896
Resistor, Thin Film, 392K, 0.1%, ±25ppm, 1/4W, 1210	MC009856	Resistor, Thin Film, 1M2, 0.1%, ±25ppm, 1/4W, 1210	MC009897
Resistor, Thin Film, 402K, 0.1%, ±25ppm, 1/4W, 1210	MC009857	Resistor, Thin Film, 1M3, 0.1%, ±25ppm, 1/4W, 1210	MC009898
Resistor, Thin Film, 412K, 0.1%, ±25ppm, 1/4W, 1210	MC009858	Resistor, Thin Film, 1M5, 0.1%, ±25ppm, 1/4W, 1210	MC009899
Resistor, Thin Film, 422K, 0.1%, ±25ppm, 1/4W, 1210	MC009859	Resistor, Thin Film, 1M6, 0.1%, ±25ppm, 1/4W, 1210	MC009900
Resistor, Thin Film, 432K, 0.1%, ±25ppm, 1/4W, 1210	MC009860	Resistor, Thin Film, 1M8, 0.1%, ±25ppm, 1/4W, 1210	MC009901
Resistor, Thin Film, 442K, 0.1%, ±25ppm, 1/4W, 1210	MC009861	Resistor, Thin Film, 2M, 0.1%, ±25ppm, 1/4W, 1210	MC009902
Resistor, Thin Film, 453K, 0.1%, ±25ppm, 1/4W, 1210	MC009862	Resistor, Thin Film, 2M4, 0.1%, ±25ppm, 1/4W, 1210	MC009903
Resistor, Thin Film, 464K, 0.1%, ±25ppm, 1/4W, 1210	MC009863	Resistor, Thin Film, 2M49, 0.1%, ±25ppm, 1/4W, 1210	MC009904
Resistor, Thin Film, 475K, 0.1%, ±25ppm, 1/4W, 1210	MC009864	Resistor, Thin Film, 4R7, 0.1%, ±25ppm, 1/4W, 2010	MC009905
Resistor, Thin Film, 487K, 0.1%, ±25ppm, 1/4W, 1210	MC009865	Resistor, Thin Film, 5R1, 0.1%, ±25ppm, 1/4W, 2010	MC009906
Resistor, Thin Film, 499K, 0.1%, ±25ppm, 1/4W, 1210	MC009866	Resistor, Thin Film, 5R6, 0.1%, ±25ppm, 1/4W, 2010	MC009907
Resistor, Thin Film, 511K, 0.1%, ±25ppm, 1/4W, 1210	MC009867	Resistor, Thin Film, 6R2, 0.1%, ±25ppm, 1/4W, 2010	MC009908
Resistor, Thin Film, 523K, 0.1%, ±25ppm, 1/4W, 1210	MC009868	Resistor, Thin Film, 6R8, 0.1%, ±25ppm, 1/4W, 2010	MC009909
Resistor, Thin Film, 536K, 0.1%, ±25ppm, 1/4W, 1210	MC009869	Resistor, Thin Film, 7R5, 0.1%, ±25ppm, 1/4W, 2010	MC009910
Resistor, Thin Film, 549K, 0.1%, ±25ppm, 1/4W, 1210	MC009870	Resistor, Thin Film, 8R2, 0.1%, ±25ppm, 1/4W, 2010	MC009911

www.element14.com
www.farnell.com
www.newark.com



Thin Film Precision Chip Resistor

Description	Part Number	Description	Part Number
Resistor, Thin Film, 9R1, 0.1%, ±25ppm, 1/4W, 2010	MC009912	Resistor, Thin Film, 26R1, 0.1%, ±25ppm, 1/4W, 2010	MC009953
Resistor, Thin Film, 10R, 0.1%, ±25ppm, 1/4W, 2010	MC009913	Resistor, Thin Film, 26R7, 0.1%, ±25ppm, 1/4W, 2010	MC009954
Resistor, Thin Film, 10R2, 0.1%, ±25ppm, 1/4W, 2010	MC009914	Resistor, Thin Film, 27R4, 0.1%, ±25ppm, 1/4W, 2010	MC009955
Resistor, Thin Film, 10R5, 0.1%, ±25ppm, 1/4W, 2010	MC009915	Resistor, Thin Film, 28R, 0.1%, ±25ppm, 1/4W, 2010	MC009956
Resistor, Thin Film, 10R7, 0.1%, ±25ppm, 1/4W, 2010	MC009916	Resistor, Thin Film, 29R4, 0.1%, ±25ppm, 1/4W, 2010	MC009957
Resistor, Thin Film, 11R, 0.1%, ±25ppm, 1/4W, 2010	MC009917	Resistor, Thin Film, 31R6, 0.1%, ±25ppm, 1/4W, 2010	MC009958
Resistor, Thin Film, 11R3, 0.1%, ±25ppm, 1/4W, 2010	MC009918	Resistor, Thin Film, 32R4, 0.1%, ±25ppm, 1/4W, 2010	MC009959
Resistor, Thin Film, 11R5, 0.1%, ±25ppm, 1/4W, 2010	MC009919	Resistor, Thin Film, 33R2, 0.1%, ±25ppm, 1/4W, 2010	MC009960
Resistor, Thin Film, 11R8, 0.1%, ±25ppm, 1/4W, 2010	MC009920	Resistor, Thin Film, 34R, 0.1%, ±25ppm, 1/4W, 2010	MC009961
Resistor, Thin Film, 12R1, 0.1%, ±25ppm, 1/4W, 2010	MC009921	Resistor, Thin Film, 34R8, 0.1%, ±25ppm, 1/4W, 2010	MC009962
Resistor, Thin Film, 12R4, 0.1%, ±25ppm, 1/4W, 2010	MC009922	Resistor, Thin Film, 35R7, 0.1%, ±25ppm, 1/4W, 2010	MC009963
Resistor, Thin Film, 12R7, 0.1%, ±25ppm, 1/4W, 2010	MC009923	Resistor, Thin Film, 36R5, 0.1%, ±25ppm, 1/4W, 2010	MC009964
Resistor, Thin Film, 13R, 0.1%, ±25ppm, 1/4W, 2010	MC009924	Resistor, Thin Film, 37R4, 0.1%, ±25ppm, 1/4W, 2010	MC009965
Resistor, Thin Film, 13R3, 0.1%, ±25ppm, 1/4W, 2010	MC009925	Resistor, Thin Film, 38R3, 0.1%, ±25ppm, 1/4W, 2010	MC009966
Resistor, Thin Film, 13R7, 0.1%, ±25ppm, 1/4W, 2010	MC009926	Resistor, Thin Film, 39R2, 0.1%, ±25ppm, 1/4W, 2010	MC009967
Resistor, Thin Film, 14R, 0.1%, ±25ppm, 1/4W, 2010	MC009927	Resistor, Thin Film, 40R2, 0.1%, ±25ppm, 1/4W, 2010	MC009968
Resistor, Thin Film, 14R3, 0.1%, ±25ppm, 1/4W, 2010	MC009928	Resistor, Thin Film, 41R2, 0.1%, ±25ppm, 1/4W, 2010	MC009969
Resistor, Thin Film, 14R7, 0.1%, ±25ppm, 1/4W, 2010	MC009929	Resistor, Thin Film, 42R2, 0.1%, ±25ppm, 1/4W, 2010	MC009970
Resistor, Thin Film, 15R, 0.1%, ±25ppm, 1/4W, 2010	MC009930	Resistor, Thin Film, 43R2, 0.1%, ±25ppm, 1/4W, 2010	MC009971
Resistor, Thin Film, 15R4, 0.1%, ±25ppm, 1/4W, 2010	MC009931	Resistor, Thin Film, 44R2, 0.1%, ±25ppm, 1/4W, 2010	MC009972
Resistor, Thin Film, 15R8, 0.1%, ±25ppm, 1/4W, 2010	MC009932	Resistor, Thin Film, 45R3, 0.1%, ±25ppm, 1/4W, 2010	MC009973
Resistor, Thin Film, 16R2, 0.1%, ±25ppm, 1/4W, 2010	MC009933	Resistor, Thin Film, 46R4, 0.1%, ±25ppm, 1/4W, 2010	MC009974
Resistor, Thin Film, 16R5, 0.1%, ±25ppm, 1/4W, 2010	MC009934	Resistor, Thin Film, 47R5, 0.1%, ±25ppm, 1/4W, 2010	MC009975
Resistor, Thin Film, 16R9, 0.1%, ±25ppm, 1/4W, 2010	MC009935	Resistor, Thin Film, 48R7, 0.1%, ±25ppm, 1/4W, 2010	MC009976
Resistor, Thin Film, 17R4, 0.1%, ±25ppm, 1/4W, 2010	MC009936	Resistor, Thin Film, 49R9, 0.1%, ±25ppm, 1/4W, 2010	MC009977
Resistor, Thin Film, 17R8, 0.1%, ±25ppm, 1/4W, 2010	MC009937	Resistor, Thin Film, 51R1, 0.1%, ±25ppm, 1/4W, 2010	MC009978
Resistor, Thin Film, 18R2, 0.1%, ±25ppm, 1/4W, 2010	MC009938	Resistor, Thin Film, 52R3, 0.1%, ±25ppm, 1/4W, 2010	MC009979
Resistor, Thin Film, 18R7, 0.1%, ±25ppm, 1/4W, 2010	MC009939	Resistor, Thin Film, 53R6, 0.1%, ±25ppm, 1/4W, 2010	MC009980
Resistor, Thin Film, 19R1, 0.1%, ±25ppm, 1/4W, 2010	MC009940	Resistor, Thin Film, 54R9, 0.1%, ±25ppm, 1/4W, 2010	MC009981
Resistor, Thin Film, 19R6, 0.1%, ±25ppm, 1/4W, 2010	MC009941	Resistor, Thin Film, 56R2, 0.1%, ±25ppm, 1/4W, 2010	MC009982
Resistor, Thin Film, 20R, 0.1%, ±25ppm, 1/4W, 2010	MC009942	Resistor, Thin Film, 57R6, 0.1%, ±25ppm, 1/4W, 2010	MC009983
Resistor, Thin Film, 20R5, 0.1%, ±25ppm, 1/4W, 2010	MC009943	Resistor, Thin Film, 59R, 0.1%, ±25ppm, 1/4W, 2010	MC009984
Resistor, Thin Film, 21R, 0.1%, ±25ppm, 1/4W, 2010	MC009944	Resistor, Thin Film, 60R4, 0.1%, ±25ppm, 1/4W, 2010	MC009985
Resistor, Thin Film, 21R5, 0.1%, ±25ppm, 1/4W, 2010	MC009945	Resistor, Thin Film, 61R9, 0.1%, ±25ppm, 1/4W, 2010	MC009986
Resistor, Thin Film, 22R1, 0.1%, ±25ppm, 1/4W, 2010	MC009946	Resistor, Thin Film, 63R4, 0.1%, ±25ppm, 1/4W, 2010	MC009987
Resistor, Thin Film, 22R6, 0.1%, ±25ppm, 1/4W, 2010	MC009947	Resistor, Thin Film, 64R9, 0.1%, ±25ppm, 1/4W, 2010	MC009988
Resistor, Thin Film, 23R2, 0.1%, ±25ppm, 1/4W, 2010	MC009948	Resistor, Thin Film, 66R5, 0.1%, ±25ppm, 1/4W, 2010	MC009989
Resistor, Thin Film, 23R7, 0.1%, ±25ppm, 1/4W, 2010	MC009949	Resistor, Thin Film, 68R1, 0.1%, ±25ppm, 1/4W, 2010	MC009990
Resistor, Thin Film, 24R3, 0.1%, ±25ppm, 1/4W, 2010	MC009950	Resistor, Thin Film, 69R8, 0.1%, ±25ppm, 1/4W, 2010	MC009991
Resistor, Thin Film, 24R9, 0.1%, ±25ppm, 1/4W, 2010	MC009951	Resistor, Thin Film, 71R5, 0.1%, ±25ppm, 1/4W, 2010	MC009992
Resistor, Thin Film, 25R5, 0.1%, ±25ppm, 1/4W, 2010	MC009952	Resistor, Thin Film, 73R2, 0.1%, ±25ppm, 1/4W, 2010	MC009993

www.element14.com
www.farnell.com
www.newark.com



Thin Film Precision Chip Resistor

Description	Part Number	Description	Part Number
Resistor, Thin Film, 75R, 0.1%, ±25ppm, 1/4W, 2010	MC009994	Resistor, Thin Film, 200R, 0.1%, ±25ppm, 1/4W, 2010	MC010035
Resistor, Thin Film, 76R8, 0.1%, ±25ppm, 1/4W, 2010	MC009995	Resistor, Thin Film, 205R, 0.1%, ±25ppm, 1/4W, 2010	MC010036
Resistor, Thin Film, 78R7, 0.1%, ±25ppm, 1/4W, 2010	MC009996	Resistor, Thin Film, 210R, 0.1%, ±25ppm, 1/4W, 2010	MC010037
Resistor, Thin Film, 80R6, 0.1%, ±25ppm, 1/4W, 2010	MC009997	Resistor, Thin Film, 215R, 0.1%, ±25ppm, 1/4W, 2010	MC010038
Resistor, Thin Film, 82R5, 0.1%, ±25ppm, 1/4W, 2010	MC009998	Resistor, Thin Film, 221R, 0.1%, ±25ppm, 1/4W, 2010	MC010039
Resistor, Thin Film, 84R5, 0.1%, ±25ppm, 1/4W, 2010	MC009999	Resistor, Thin Film, 226R, 0.1%, ±25ppm, 1/4W, 2010	MC010040
Resistor, Thin Film, 86R6, 0.1%, ±25ppm, 1/4W, 2010	MC010000	Resistor, Thin Film, 232R, 0.1%, ±25ppm, 1/4W, 2010	MC010041
Resistor, Thin Film, 88R7, 0.1%, ±25ppm, 1/4W, 2010	MC010001	Resistor, Thin Film, 237R, 0.1%, ±25ppm, 1/4W, 2010	MC010042
Resistor, Thin Film, 90R9, 0.1%, ±25ppm, 1/4W, 2010	MC010002	Resistor, Thin Film, 243R, 0.1%, ±25ppm, 1/4W, 2010	MC010043
Resistor, Thin Film, 93R1, 0.1%, ±25ppm, 1/4W, 2010	MC010003	Resistor, Thin Film, 249R, 0.1%, ±25ppm, 1/4W, 2010	MC010044
Resistor, Thin Film, 95R3, 0.1%, ±25ppm, 1/4W, 2010	MC010004	Resistor, Thin Film, 255R, 0.1%, ±25ppm, 1/4W, 2010	MC010045
Resistor, Thin Film, 97R6, 0.1%, ±25ppm, 1/4W, 2010	MC010005	Resistor, Thin Film, 261R, 0.1%, ±25ppm, 1/4W, 2010	MC010046
Resistor, Thin Film, 100R, 0.1%, ±25ppm, 1/4W, 2010	MC010006	Resistor, Thin Film, 267R, 0.1%, ±25ppm, 1/4W, 2010	MC010047
Resistor, Thin Film, 102R, 0.1%, ±25ppm, 1/4W, 2010	MC010007	Resistor, Thin Film, 274R, 0.1%, ±25ppm, 1/4W, 2010	MC010048
Resistor, Thin Film, 105R, 0.1%, ±25ppm, 1/4W, 2010	MC010008	Resistor, Thin Film, 280R, 0.1%, ±25ppm, 1/4W, 2010	MC010049
Resistor, Thin Film, 107R, 0.1%, ±25ppm, 1/4W, 2010	MC010009	Resistor, Thin Film, 294R, 0.1%, ±25ppm, 1/4W, 2010	MC010050
Resistor, Thin Film, 110R, 0.1%, ±25ppm, 1/4W, 2010	MC010010	Resistor, Thin Film, 316R, 0.1%, ±25ppm, 1/4W, 2010	MC010051
Resistor, Thin Film, 113R, 0.1%, ±25ppm, 1/4W, 2010	MC010011	Resistor, Thin Film, 324R, 0.1%, ±25ppm, 1/4W, 2010	MC010052
Resistor, Thin Film, 115R, 0.1%, ±25ppm, 1/4W, 2010	MC010012	Resistor, Thin Film, 332R, 0.1%, ±25ppm, 1/4W, 2010	MC010053
Resistor, Thin Film, 118R, 0.1%, ±25ppm, 1/4W, 2010	MC010013	Resistor, Thin Film, 340R, 0.1%, ±25ppm, 1/4W, 2010	MC010054
Resistor, Thin Film, 121R, 0.1%, ±25ppm, 1/4W, 2010	MC010014	Resistor, Thin Film, 348R, 0.1%, ±25ppm, 1/4W, 2010	MC010055
Resistor, Thin Film, 124R, 0.1%, ±25ppm, 1/4W, 2010	MC010015	Resistor, Thin Film, 357R, 0.1%, ±25ppm, 1/4W, 2010	MC010056
Resistor, Thin Film, 127R, 0.1%, ±25ppm, 1/4W, 2010	MC010016	Resistor, Thin Film, 365R, 0.1%, ±25ppm, 1/4W, 2010	MC010057
Resistor, Thin Film, 130R, 0.1%, ±25ppm, 1/4W, 2010	MC010017	Resistor, Thin Film, 374R, 0.1%, ±25ppm, 1/4W, 2010	MC010058
Resistor, Thin Film, 133R, 0.1%, ±25ppm, 1/4W, 2010	MC010018	Resistor, Thin Film, 383R, 0.1%, ±25ppm, 1/4W, 2010	MC010059
Resistor, Thin Film, 137R, 0.1%, ±25ppm, 1/4W, 2010	MC010019	Resistor, Thin Film, 392R, 0.1%, ±25ppm, 1/4W, 2010	MC010060
Resistor, Thin Film, 140R, 0.1%, ±25ppm, 1/4W, 2010	MC010020	Resistor, Thin Film, 402R, 0.1%, ±25ppm, 1/4W, 2010	MC010061
Resistor, Thin Film, 143R, 0.1%, ±25ppm, 1/4W, 2010	MC010021	Resistor, Thin Film, 412R, 0.1%, ±25ppm, 1/4W, 2010	MC010062
Resistor, Thin Film, 147R, 0.1%, ±25ppm, 1/4W, 2010	MC010022	Resistor, Thin Film, 422R, 0.1%, ±25ppm, 1/4W, 2010	MC010063
Resistor, Thin Film, 150R, 0.1%, ±25ppm, 1/4W, 2010	MC010023	Resistor, Thin Film, 432R, 0.1%, ±25ppm, 1/4W, 2010	MC010064
Resistor, Thin Film, 154R, 0.1%, ±25ppm, 1/4W, 2010	MC010024	Resistor, Thin Film, 442R, 0.1%, ±25ppm, 1/4W, 2010	MC010065
Resistor, Thin Film, 158R, 0.1%, ±25ppm, 1/4W, 2010	MC010025	Resistor, Thin Film, 453R, 0.1%, ±25ppm, 1/4W, 2010	MC010066
Resistor, Thin Film, 162R, 0.1%, ±25ppm, 1/4W, 2010	MC010026	Resistor, Thin Film, 464R, 0.1%, ±25ppm, 1/4W, 2010	MC010067
Resistor, Thin Film, 165R, 0.1%, ±25ppm, 1/4W, 2010	MC010027	Resistor, Thin Film, 475R, 0.1%, ±25ppm, 1/4W, 2010	MC010068
Resistor, Thin Film, 169R, 0.1%, ±25ppm, 1/4W, 2010	MC010028	Resistor, Thin Film, 487R, 0.1%, ±25ppm, 1/4W, 2010	MC010069
Resistor, Thin Film, 174R, 0.1%, ±25ppm, 1/4W, 2010	MC010029	Resistor, Thin Film, 499R, 0.1%, ±25ppm, 1/4W, 2010	MC010070
Resistor, Thin Film, 178R, 0.1%, ±25ppm, 1/4W, 2010	MC010030	Resistor, Thin Film, 511R, 0.1%, ±25ppm, 1/4W, 2010	MC010071
Resistor, Thin Film, 182R, 0.1%, ±25ppm, 1/4W, 2010	MC010031	Resistor, Thin Film, 523R, 0.1%, ±25ppm, 1/4W, 2010	MC010072
Resistor, Thin Film, 187R, 0.1%, ±25ppm, 1/4W, 2010	MC010032	Resistor, Thin Film, 536R, 0.1%, ±25ppm, 1/4W, 2010	MC010073
Resistor, Thin Film, 191R, 0.1%, ±25ppm, 1/4W, 2010	MC010033	Resistor, Thin Film, 549R, 0.1%, ±25ppm, 1/4W, 2010	MC010074
Resistor, Thin Film, 196R, 0.1%, ±25ppm, 1/4W, 2010	MC010034	Resistor, Thin Film, 562R, 0.1%, ±25ppm, 1/4W, 2010	MC010075

www.element14.com
www.farnell.com
www.newark.com



Thin Film Precision Chip Resistor

Description	Part Number	Description	Part Number
Resistor, Thin Film, 576R, 0.1%, ±25ppm, 1/4W, 2010	MC010076	Resistor, Thin Film, 1K54, 0.1%, ±25ppm, 1/4W, 2010	MC010117
Resistor, Thin Film, 590R, 0.1%, ±25ppm, 1/4W, 2010	MC010077	Resistor, Thin Film, 1K58, 0.1%, ±25ppm, 1/4W, 2010	MC010118
Resistor, Thin Film, 604R, 0.1%, ±25ppm, 1/4W, 2010	MC010078	Resistor, Thin Film, 1K62, 0.1%, ±25ppm, 1/4W, 2010	MC010119
Resistor, Thin Film, 619R, 0.1%, ±25ppm, 1/4W, 2010	MC010079	Resistor, Thin Film, 1K65, 0.1%, ±25ppm, 1/4W, 2010	MC010120
Resistor, Thin Film, 634R, 0.1%, ±25ppm, 1/4W, 2010	MC010080	Resistor, Thin Film, 1K69, 0.1%, ±25ppm, 1/4W, 2010	MC010121
Resistor, Thin Film, 649R, 0.1%, ±25ppm, 1/4W, 2010	MC010081	Resistor, Thin Film, 1K74, 0.1%, ±25ppm, 1/4W, 2010	MC010122
Resistor, Thin Film, 665R, 0.1%, ±25ppm, 1/4W, 2010	MC010082	Resistor, Thin Film, 1K78, 0.1%, ±25ppm, 1/4W, 2010	MC010123
Resistor, Thin Film, 681R, 0.1%, ±25ppm, 1/4W, 2010	MC010083	Resistor, Thin Film, 1K82, 0.1%, ±25ppm, 1/4W, 2010	MC010124
Resistor, Thin Film, 698R, 0.1%, ±25ppm, 1/4W, 2010	MC010084	Resistor, Thin Film, 1K87, 0.1%, ±25ppm, 1/4W, 2010	MC010125
Resistor, Thin Film, 715R, 0.1%, ±25ppm, 1/4W, 2010	MC010085	Resistor, Thin Film, 1K91, 0.1%, ±25ppm, 1/4W, 2010	MC010126
Resistor, Thin Film, 732R, 0.1%, ±25ppm, 1/4W, 2010	MC010086	Resistor, Thin Film, 1K96, 0.1%, ±25ppm, 1/4W, 2010	MC010127
Resistor, Thin Film, 750R, 0.1%, ±25ppm, 1/4W, 2010	MC010087	Resistor, Thin Film, 2K, 0.1%, ±25ppm, 1/4W, 2010	MC010128
Resistor, Thin Film, 768R, 0.1%, ±25ppm, 1/4W, 2010	MC010088	Resistor, Thin Film, 2K05, 0.1%, ±25ppm, 1/4W, 2010	MC010129
Resistor, Thin Film, 787R, 0.1%, ±25ppm, 1/4W, 2010	MC010089	Resistor, Thin Film, 2K1, 0.1%, ±25ppm, 1/4W, 2010	MC010130
Resistor, Thin Film, 806R, 0.1%, ±25ppm, 1/4W, 2010	MC010090	Resistor, Thin Film, 2K15, 0.1%, ±25ppm, 1/4W, 2010	MC010131
Resistor, Thin Film, 825R, 0.1%, ±25ppm, 1/4W, 2010	MC010091	Resistor, Thin Film, 2K21, 0.1%, ±25ppm, 1/4W, 2010	MC010132
Resistor, Thin Film, 845R, 0.1%, ±25ppm, 1/4W, 2010	MC010092	Resistor, Thin Film, 2K26, 0.1%, ±25ppm, 1/4W, 2010	MC010133
Resistor, Thin Film, 866R, 0.1%, ±25ppm, 1/4W, 2010	MC010093	Resistor, Thin Film, 2K32, 0.1%, ±25ppm, 1/4W, 2010	MC010134
Resistor, Thin Film, 887R, 0.1%, ±25ppm, 1/4W, 2010	MC010094	Resistor, Thin Film, 2K37, 0.1%, ±25ppm, 1/4W, 2010	MC010135
Resistor, Thin Film, 909R, 0.1%, ±25ppm, 1/4W, 2010	MC010095	Resistor, Thin Film, 2K43, 0.1%, ±25ppm, 1/4W, 2010	MC010136
Resistor, Thin Film, 931R, 0.1%, ±25ppm, 1/4W, 2010	MC010096	Resistor, Thin Film, 2K49, 0.1%, ±25ppm, 1/4W, 2010	MC010137
Resistor, Thin Film, 953R, 0.1%, ±25ppm, 1/4W, 2010	MC010097	Resistor, Thin Film, 2K55, 0.1%, ±25ppm, 1/4W, 2010	MC010138
Resistor, Thin Film, 976R, 0.1%, ±25ppm, 1/4W, 2010	MC010098	Resistor, Thin Film, 2K61, 0.1%, ±25ppm, 1/4W, 2010	MC010139
Resistor, Thin Film, 1K, 0.1%, ±25ppm, 1/4W, 2010	MC010099	Resistor, Thin Film, 2K67, 0.1%, ±25ppm, 1/4W, 2010	MC010140
Resistor, Thin Film, 1K02, 0.1%, ±25ppm, 1/4W, 2010	MC010100	Resistor, Thin Film, 2K74, 0.1%, ±25ppm, 1/4W, 2010	MC010141
Resistor, Thin Film, 1K05, 0.1%, ±25ppm, 1/4W, 2010	MC010101	Resistor, Thin Film, 2K8, 0.1%, ±25ppm, 1/4W, 2010	MC010142
Resistor, Thin Film, 1K07, 0.1%, ±25ppm, 1/4W, 2010	MC010102	Resistor, Thin Film, 2K94, 0.1%, ±25ppm, 1/4W, 2010	MC010143
Resistor, Thin Film, 1K1, 0.1%, ±25ppm, 1/4W, 2010	MC010103	Resistor, Thin Film, 3K16, 0.1%, ±25ppm, 1/4W, 2010	MC010144
Resistor, Thin Film, 1K13, 0.1%, ±25ppm, 1/4W, 2010	MC010104	Resistor, Thin Film, 3K24, 0.1%, ±25ppm, 1/4W, 2010	MC010145
Resistor, Thin Film, 1K15, 0.1%, ±25ppm, 1/4W, 2010	MC010105	Resistor, Thin Film, 3K32, 0.1%, ±25ppm, 1/4W, 2010	MC010146
Resistor, Thin Film, 1K18, 0.1%, ±25ppm, 1/4W, 2010	MC010106	Resistor, Thin Film, 3K4, 0.1%, ±25ppm, 1/4W, 2010	MC010147
Resistor, Thin Film, 1K21, 0.1%, ±25ppm, 1/4W, 2010	MC010107	Resistor, Thin Film, 3K48, 0.1%, ±25ppm, 1/4W, 2010	MC010148
Resistor, Thin Film, 1K24, 0.1%, ±25ppm, 1/4W, 2010	MC010108	Resistor, Thin Film, 3K57, 0.1%, ±25ppm, 1/4W, 2010	MC010149
Resistor, Thin Film, 1K27, 0.1%, ±25ppm, 1/4W, 2010	MC010109	Resistor, Thin Film, 3K65, 0.1%, ±25ppm, 1/4W, 2010	MC010150
Resistor, Thin Film, 1K3, 0.1%, ±25ppm, 1/4W, 2010	MC010110	Resistor, Thin Film, 3K74, 0.1%, ±25ppm, 1/4W, 2010	MC010151
Resistor, Thin Film, 1K33, 0.1%, ±25ppm, 1/4W, 2010	MC010111	Resistor, Thin Film, 3K83, 0.1%, ±25ppm, 1/4W, 2010	MC010152
Resistor, Thin Film, 1K37, 0.1%, ±25ppm, 1/4W, 2010	MC010112	Resistor, Thin Film, 3K92, 0.1%, ±25ppm, 1/4W, 2010	MC010153
Resistor, Thin Film, 1K4, 0.1%, ±25ppm, 1/4W, 2010	MC010113	Resistor, Thin Film, 4K02, 0.1%, ±25ppm, 1/4W, 2010	MC010154
Resistor, Thin Film, 1K43, 0.1%, ±25ppm, 1/4W, 2010	MC010114	Resistor, Thin Film, 4K12, 0.1%, ±25ppm, 1/4W, 2010	MC010155
Resistor, Thin Film, 1K47, 0.1%, ±25ppm, 1/4W, 2010	MC010115	Resistor, Thin Film, 4K22, 0.1%, ±25ppm, 1/4W, 2010	MC010156
Resistor, Thin Film, 1K5, 0.1%, ±25ppm, 1/4W, 2010	MC010116	Resistor, Thin Film, 4K32, 0.1%, ±25ppm, 1/4W, 2010	MC010157

www.element14.com
www.farnell.com
www.newark.com



Thin Film Precision Chip Resistor

Description	Part Number	Description	Part Number
Resistor, Thin Film, 4K42, 0.1%, ±25ppm, 1/4W, 2010	MC010158	Resistor, Thin Film, 11K8, 0.1%, ±25ppm, 1/4W, 2010	MC010199
Resistor, Thin Film, 4K53, 0.1%, ±25ppm, 1/4W, 2010	MC010159	Resistor, Thin Film, 12K1, 0.1%, ±25ppm, 1/4W, 2010	MC010200
Resistor, Thin Film, 4K64, 0.1%, ±25ppm, 1/4W, 2010	MC010160	Resistor, Thin Film, 12K4, 0.1%, ±25ppm, 1/4W, 2010	MC010201
Resistor, Thin Film, 4K75, 0.1%, ±25ppm, 1/4W, 2010	MC010161	Resistor, Thin Film, 12K7, 0.1%, ±25ppm, 1/4W, 2010	MC010202
Resistor, Thin Film, 4K87, 0.1%, ±25ppm, 1/4W, 2010	MC010162	Resistor, Thin Film, 13K, 0.1%, ±25ppm, 1/4W, 2010	MC010203
Resistor, Thin Film, 4K99, 0.1%, ±25ppm, 1/4W, 2010	MC010163	Resistor, Thin Film, 13K3, 0.1%, ±25ppm, 1/4W, 2010	MC010204
Resistor, Thin Film, 5K11, 0.1%, ±25ppm, 1/4W, 2010	MC010164	Resistor, Thin Film, 13K7, 0.1%, ±25ppm, 1/4W, 2010	MC010205
Resistor, Thin Film, 5K23, 0.1%, ±25ppm, 1/4W, 2010	MC010165	Resistor, Thin Film, 14K, 0.1%, ±25ppm, 1/4W, 2010	MC010206
Resistor, Thin Film, 5K36, 0.1%, ±25ppm, 1/4W, 2010	MC010166	Resistor, Thin Film, 14K3, 0.1%, ±25ppm, 1/4W, 2010	MC010207
Resistor, Thin Film, 5K49, 0.1%, ±25ppm, 1/4W, 2010	MC010167	Resistor, Thin Film, 14K7, 0.1%, ±25ppm, 1/4W, 2010	MC010208
Resistor, Thin Film, 5K62, 0.1%, ±25ppm, 1/4W, 2010	MC010168	Resistor, Thin Film, 15K, 0.1%, ±25ppm, 1/4W, 2010	MC010209
Resistor, Thin Film, 5K76, 0.1%, ±25ppm, 1/4W, 2010	MC010169	Resistor, Thin Film, 15K4, 0.1%, ±25ppm, 1/4W, 2010	MC010210
Resistor, Thin Film, 5K9, 0.1%, ±25ppm, 1/4W, 2010	MC010170	Resistor, Thin Film, 15K8, 0.1%, ±25ppm, 1/4W, 2010	MC010211
Resistor, Thin Film, 6K04, 0.1%, ±25ppm, 1/4W, 2010	MC010171	Resistor, Thin Film, 16K2, 0.1%, ±25ppm, 1/4W, 2010	MC010212
Resistor, Thin Film, 6K19, 0.1%, ±25ppm, 1/4W, 2010	MC010172	Resistor, Thin Film, 16K5, 0.1%, ±25ppm, 1/4W, 2010	MC010213
Resistor, Thin Film, 6K34, 0.1%, ±25ppm, 1/4W, 2010	MC010173	Resistor, Thin Film, 16K9, 0.1%, ±25ppm, 1/4W, 2010	MC010214
Resistor, Thin Film, 6K49, 0.1%, ±25ppm, 1/4W, 2010	MC010174	Resistor, Thin Film, 17K4, 0.1%, ±25ppm, 1/4W, 2010	MC010215
Resistor, Thin Film, 6K65, 0.1%, ±25ppm, 1/4W, 2010	MC010175	Resistor, Thin Film, 17K8, 0.1%, ±25ppm, 1/4W, 2010	MC010216
Resistor, Thin Film, 6K81, 0.1%, ±25ppm, 1/4W, 2010	MC010176	Resistor, Thin Film, 18K2, 0.1%, ±25ppm, 1/4W, 2010	MC010217
Resistor, Thin Film, 6K98, 0.1%, ±25ppm, 1/4W, 2010	MC010177	Resistor, Thin Film, 18K7, 0.1%, ±25ppm, 1/4W, 2010	MC010218
Resistor, Thin Film, 7K15, 0.1%, ±25ppm, 1/4W, 2010	MC010178	Resistor, Thin Film, 19K1, 0.1%, ±25ppm, 1/4W, 2010	MC010219
Resistor, Thin Film, 7K32, 0.1%, ±25ppm, 1/4W, 2010	MC010179	Resistor, Thin Film, 19K6, 0.1%, ±25ppm, 1/4W, 2010	MC010220
Resistor, Thin Film, 7K5, 0.1%, ±25ppm, 1/4W, 2010	MC010180	Resistor, Thin Film, 20K, 0.1%, ±25ppm, 1/4W, 2010	MC010221
Resistor, Thin Film, 7K68, 0.1%, ±25ppm, 1/4W, 2010	MC010181	Resistor, Thin Film, 20K5, 0.1%, ±25ppm, 1/4W, 2010	MC010222
Resistor, Thin Film, 7K87, 0.1%, ±25ppm, 1/4W, 2010	MC010182	Resistor, Thin Film, 21K, 0.1%, ±25ppm, 1/4W, 2010	MC010223
Resistor, Thin Film, 8K06, 0.1%, ±25ppm, 1/4W, 2010	MC010183	Resistor, Thin Film, 21K5, 0.1%, ±25ppm, 1/4W, 2010	MC010224
Resistor, Thin Film, 8K25, 0.1%, ±25ppm, 1/4W, 2010	MC010184	Resistor, Thin Film, 22K1, 0.1%, ±25ppm, 1/4W, 2010	MC010225
Resistor, Thin Film, 8K45, 0.1%, ±25ppm, 1/4W, 2010	MC010185	Resistor, Thin Film, 22K6, 0.1%, ±25ppm, 1/4W, 2010	MC010226
Resistor, Thin Film, 8K66, 0.1%, ±25ppm, 1/4W, 2010	MC010186	Resistor, Thin Film, 23K2, 0.1%, ±25ppm, 1/4W, 2010	MC010227
Resistor, Thin Film, 8K87, 0.1%, ±25ppm, 1/4W, 2010	MC010187	Resistor, Thin Film, 23K7, 0.1%, ±25ppm, 1/4W, 2010	MC010228
Resistor, Thin Film, 9K09, 0.1%, ±25ppm, 1/4W, 2010	MC010188	Resistor, Thin Film, 24K3, 0.1%, ±25ppm, 1/4W, 2010	MC010229
Resistor, Thin Film, 9K31, 0.1%, ±25ppm, 1/4W, 2010	MC010189	Resistor, Thin Film, 24K9, 0.1%, ±25ppm, 1/4W, 2010	MC010230
Resistor, Thin Film, 9K53, 0.1%, ±25ppm, 1/4W, 2010	MC010190	Resistor, Thin Film, 25K5, 0.1%, ±25ppm, 1/4W, 2010	MC010231
Resistor, Thin Film, 9K76, 0.1%, ±25ppm, 1/4W, 2010	MC010191	Resistor, Thin Film, 26K1, 0.1%, ±25ppm, 1/4W, 2010	MC010232
Resistor, Thin Film, 10K, 0.1%, ±25ppm, 1/4W, 2010	MC010192	Resistor, Thin Film, 26K7, 0.1%, ±25ppm, 1/4W, 2010	MC010233
Resistor, Thin Film, 10K2, 0.1%, ±25ppm, 1/4W, 2010	MC010193	Resistor, Thin Film, 27K4, 0.1%, ±25ppm, 1/4W, 2010	MC010234
Resistor, Thin Film, 10K5, 0.1%, ±25ppm, 1/4W, 2010	MC010194	Resistor, Thin Film, 28K, 0.1%, ±25ppm, 1/4W, 2010	MC010235
Resistor, Thin Film, 10K7, 0.1%, ±25ppm, 1/4W, 2010	MC010195	Resistor, Thin Film, 29K4, 0.1%, ±25ppm, 1/4W, 2010	MC010236
Resistor, Thin Film, 11K, 0.1%, ±25ppm, 1/4W, 2010	MC010196	Resistor, Thin Film, 31K6, 0.1%, ±25ppm, 1/4W, 2010	MC010237
Resistor, Thin Film, 11K3, 0.1%, ±25ppm, 1/4W, 2010	MC010197	Resistor, Thin Film, 32K4, 0.1%, ±25ppm, 1/4W, 2010	MC010238
Resistor, Thin Film, 11K5, 0.1%, ±25ppm, 1/4W, 2010	MC010198	Resistor, Thin Film, 33K2, 0.1%, ±25ppm, 1/4W, 2010	MC010239

www.element14.com
www.farnell.com
www.newark.com



Thin Film Precision Chip Resistor

Description	Part Number	Description	Part Number
Resistor, Thin Film, 34K, 0.1%, ±25ppm, 1/4W, 2010	MC010240	Resistor, Thin Film, 90K9, 0.1%, ±25ppm, 1/4W, 2010	MC010281
Resistor, Thin Film, 34K8, 0.1%, ±25ppm, 1/4W, 2010	MC010241	Resistor, Thin Film, 93K1, 0.1%, ±25ppm, 1/4W, 2010	MC010282
Resistor, Thin Film, 35K7, 0.1%, ±25ppm, 1/4W, 2010	MC010242	Resistor, Thin Film, 95K3, 0.1%, ±25ppm, 1/4W, 2010	MC010283
Resistor, Thin Film, 36K5, 0.1%, ±25ppm, 1/4W, 2010	MC010243	Resistor, Thin Film, 97K6, 0.1%, ±25ppm, 1/4W, 2010	MC010284
Resistor, Thin Film, 37K4, 0.1%, ±25ppm, 1/4W, 2010	MC010244	Resistor, Thin Film, 100K, 0.1%, ±25ppm, 1/4W, 2010	MC010285
Resistor, Thin Film, 38K3, 0.1%, ±25ppm, 1/4W, 2010	MC010245	Resistor, Thin Film, 102K, 0.1%, ±25ppm, 1/4W, 2010	MC010286
Resistor, Thin Film, 39K2, 0.1%, ±25ppm, 1/4W, 2010	MC010246	Resistor, Thin Film, 105K, 0.1%, ±25ppm, 1/4W, 2010	MC010287
Resistor, Thin Film, 40K2, 0.1%, ±25ppm, 1/4W, 2010	MC010247	Resistor, Thin Film, 107K, 0.1%, ±25ppm, 1/4W, 2010	MC010288
Resistor, Thin Film, 41K2, 0.1%, ±25ppm, 1/4W, 2010	MC010248	Resistor, Thin Film, 110K, 0.1%, ±25ppm, 1/4W, 2010	MC010289
Resistor, Thin Film, 42K2, 0.1%, ±25ppm, 1/4W, 2010	MC010249	Resistor, Thin Film, 113K, 0.1%, ±25ppm, 1/4W, 2010	MC010290
Resistor, Thin Film, 43K2, 0.1%, ±25ppm, 1/4W, 2010	MC010250	Resistor, Thin Film, 115K, 0.1%, ±25ppm, 1/4W, 2010	MC010291
Resistor, Thin Film, 44K2, 0.1%, ±25ppm, 1/4W, 2010	MC010251	Resistor, Thin Film, 118K, 0.1%, ±25ppm, 1/4W, 2010	MC010292
Resistor, Thin Film, 45K3, 0.1%, ±25ppm, 1/4W, 2010	MC010252	Resistor, Thin Film, 121K, 0.1%, ±25ppm, 1/4W, 2010	MC010293
Resistor, Thin Film, 46K4, 0.1%, ±25ppm, 1/4W, 2010	MC010253	Resistor, Thin Film, 124K, 0.1%, ±25ppm, 1/4W, 2010	MC010294
Resistor, Thin Film, 47K5, 0.1%, ±25ppm, 1/4W, 2010	MC010254	Resistor, Thin Film, 127K, 0.1%, ±25ppm, 1/4W, 2010	MC010295
Resistor, Thin Film, 48K7, 0.1%, ±25ppm, 1/4W, 2010	MC010255	Resistor, Thin Film, 130K, 0.1%, ±25ppm, 1/4W, 2010	MC010296
Resistor, Thin Film, 49K9, 0.1%, ±25ppm, 1/4W, 2010	MC010256	Resistor, Thin Film, 133K, 0.1%, ±25ppm, 1/4W, 2010	MC010297
Resistor, Thin Film, 51K1, 0.1%, ±25ppm, 1/4W, 2010	MC010257	Resistor, Thin Film, 137K, 0.1%, ±25ppm, 1/4W, 2010	MC010298
Resistor, Thin Film, 52K3, 0.1%, ±25ppm, 1/4W, 2010	MC010258	Resistor, Thin Film, 140K, 0.1%, ±25ppm, 1/4W, 2010	MC010299
Resistor, Thin Film, 53K6, 0.1%, ±25ppm, 1/4W, 2010	MC010259	Resistor, Thin Film, 143K, 0.1%, ±25ppm, 1/4W, 2010	MC010300
Resistor, Thin Film, 54K9, 0.1%, ±25ppm, 1/4W, 2010	MC010260	Resistor, Thin Film, 147K, 0.1%, ±25ppm, 1/4W, 2010	MC010301
Resistor, Thin Film, 56K2, 0.1%, ±25ppm, 1/4W, 2010	MC010261	Resistor, Thin Film, 150K, 0.1%, ±25ppm, 1/4W, 2010	MC010302
Resistor, Thin Film, 57K6, 0.1%, ±25ppm, 1/4W, 2010	MC010262	Resistor, Thin Film, 154K, 0.1%, ±25ppm, 1/4W, 2010	MC010303
Resistor, Thin Film, 59K, 0.1%, ±25ppm, 1/4W, 2010	MC010263	Resistor, Thin Film, 158K, 0.1%, ±25ppm, 1/4W, 2010	MC010304
Resistor, Thin Film, 60K4, 0.1%, ±25ppm, 1/4W, 2010	MC010264	Resistor, Thin Film, 162K, 0.1%, ±25ppm, 1/4W, 2010	MC010305
Resistor, Thin Film, 61K9, 0.1%, ±25ppm, 1/4W, 2010	MC010265	Resistor, Thin Film, 165K, 0.1%, ±25ppm, 1/4W, 2010	MC010306
Resistor, Thin Film, 63K4, 0.1%, ±25ppm, 1/4W, 2010	MC010266	Resistor, Thin Film, 169K, 0.1%, ±25ppm, 1/4W, 2010	MC010307
Resistor, Thin Film, 64K9, 0.1%, ±25ppm, 1/4W, 2010	MC010267	Resistor, Thin Film, 174K, 0.1%, ±25ppm, 1/4W, 2010	MC010308
Resistor, Thin Film, 66K5, 0.1%, ±25ppm, 1/4W, 2010	MC010268	Resistor, Thin Film, 178K, 0.1%, ±25ppm, 1/4W, 2010	MC010309
Resistor, Thin Film, 68K1, 0.1%, ±25ppm, 1/4W, 2010	MC010269	Resistor, Thin Film, 182K, 0.1%, ±25ppm, 1/4W, 2010	MC010310
Resistor, Thin Film, 69K8, 0.1%, ±25ppm, 1/4W, 2010	MC010270	Resistor, Thin Film, 187K, 0.1%, ±25ppm, 1/4W, 2010	MC010311
Resistor, Thin Film, 71K5, 0.1%, ±25ppm, 1/4W, 2010	MC010271	Resistor, Thin Film, 191K, 0.1%, ±25ppm, 1/4W, 2010	MC010312
Resistor, Thin Film, 73K2, 0.1%, ±25ppm, 1/4W, 2010	MC010272	Resistor, Thin Film, 196K, 0.1%, ±25ppm, 1/4W, 2010	MC010313
Resistor, Thin Film, 75K, 0.1%, ±25ppm, 1/4W, 2010	MC010273	Resistor, Thin Film, 200K, 0.1%, ±25ppm, 1/4W, 2010	MC010314
Resistor, Thin Film, 76K8, 0.1%, ±25ppm, 1/4W, 2010	MC010274	Resistor, Thin Film, 205K, 0.1%, ±25ppm, 1/4W, 2010	MC010315
Resistor, Thin Film, 78K7, 0.1%, ±25ppm, 1/4W, 2010	MC010275	Resistor, Thin Film, 210K, 0.1%, ±25ppm, 1/4W, 2010	MC010316
Resistor, Thin Film, 80K6, 0.1%, ±25ppm, 1/4W, 2010	MC010276	Resistor, Thin Film, 215K, 0.1%, ±25ppm, 1/4W, 2010	MC010317
Resistor, Thin Film, 82K5, 0.1%, ±25ppm, 1/4W, 2010	MC010277	Resistor, Thin Film, 221K, 0.1%, ±25ppm, 1/4W, 2010	MC010318
Resistor, Thin Film, 84K5, 0.1%, ±25ppm, 1/4W, 2010	MC010278	Resistor, Thin Film, 226K, 0.1%, ±25ppm, 1/4W, 2010	MC010319
Resistor, Thin Film, 86K6, 0.1%, ±25ppm, 1/4W, 2010	MC010279	Resistor, Thin Film, 232K, 0.1%, ±25ppm, 1/4W, 2010	MC010320
Resistor, Thin Film, 88K7, 0.1%, ±25ppm, 1/4W, 2010	MC010280	Resistor, Thin Film, 237K, 0.1%, ±25ppm, 1/4W, 2010	MC010321

www.element14.com
www.farnell.com
www.newark.com



Thin Film Precision Chip Resistor

Description	Part Number	Description	Part Number
Resistor, Thin Film, 243K, 0.1%, ±25ppm, 1/4W, 2010	MC010322	Resistor, Thin Film, 698K, 0.1%, ±25ppm, 1/4W, 2010	MC010363
Resistor, Thin Film, 249K, 0.1%, ±25ppm, 1/4W, 2010	MC010323	Resistor, Thin Film, 715K, 0.1%, ±25ppm, 1/4W, 2010	MC010364
Resistor, Thin Film, 255K, 0.1%, ±25ppm, 1/4W, 2010	MC010324	Resistor, Thin Film, 732K, 0.1%, ±25ppm, 1/4W, 2010	MC010365
Resistor, Thin Film, 261K, 0.1%, ±25ppm, 1/4W, 2010	MC010325	Resistor, Thin Film, 750K, 0.1%, ±25ppm, 1/4W, 2010	MC010366
Resistor, Thin Film, 267K, 0.1%, ±25ppm, 1/4W, 2010	MC010326	Resistor, Thin Film, 768K, 0.1%, ±25ppm, 1/4W, 2010	MC010367
Resistor, Thin Film, 274K, 0.1%, ±25ppm, 1/4W, 2010	MC010327	Resistor, Thin Film, 787K, 0.1%, ±25ppm, 1/4W, 2010	MC010368
Resistor, Thin Film, 280K, 0.1%, ±25ppm, 1/4W, 2010	MC010328	Resistor, Thin Film, 806K, 0.1%, ±25ppm, 1/4W, 2010	MC010369
Resistor, Thin Film, 294K, 0.1%, ±25ppm, 1/4W, 2010	MC010329	Resistor, Thin Film, 825K, 0.1%, ±25ppm, 1/4W, 2010	MC010370
Resistor, Thin Film, 316K, 0.1%, ±25ppm, 1/4W, 2010	MC010330	Resistor, Thin Film, 845K, 0.1%, ±25ppm, 1/4W, 2010	MC010371
Resistor, Thin Film, 324K, 0.1%, ±25ppm, 1/4W, 2010	MC010331	Resistor, Thin Film, 866K, 0.1%, ±25ppm, 1/4W, 2010	MC010372
Resistor, Thin Film, 332K, 0.1%, ±25ppm, 1/4W, 2010	MC010332	Resistor, Thin Film, 887K, 0.1%, ±25ppm, 1/4W, 2010	MC010373
Resistor, Thin Film, 340K, 0.1%, ±25ppm, 1/4W, 2010	MC010333	Resistor, Thin Film, 909K, 0.1%, ±25ppm, 1/4W, 2010	MC010374
Resistor, Thin Film, 348K, 0.1%, ±25ppm, 1/4W, 2010	MC010334	Resistor, Thin Film, 931K, 0.1%, ±25ppm, 1/4W, 2010	MC010375
Resistor, Thin Film, 357K, 0.1%, ±25ppm, 1/4W, 2010	MC010335	Resistor, Thin Film, 953K, 0.1%, ±25ppm, 1/4W, 2010	MC010376
Resistor, Thin Film, 365K, 0.1%, ±25ppm, 1/4W, 2010	MC010336	Resistor, Thin Film, 976K, 0.1%, ±25ppm, 1/4W, 2010	MC010377
Resistor, Thin Film, 374K, 0.1%, ±25ppm, 1/4W, 2010	MC010337	Resistor, Thin Film, 1M, 0.1%, ±25ppm, 1/4W, 2010	MC010378
Resistor, Thin Film, 383K, 0.1%, ±25ppm, 1/4W, 2010	MC010338	Resistor, Thin Film, 1M1, 0.1%, ±25ppm, 1/4W, 2010	MC010379
Resistor, Thin Film, 392K, 0.1%, ±25ppm, 1/4W, 2010	MC010339	Resistor, Thin Film, 1M2, 0.1%, ±25ppm, 1/4W, 2010	MC010380
Resistor, Thin Film, 402K, 0.1%, ±25ppm, 1/4W, 2010	MC010340	Resistor, Thin Film, 1M3, 0.1%, ±25ppm, 1/4W, 2010	MC010381
Resistor, Thin Film, 412K, 0.1%, ±25ppm, 1/4W, 2010	MC010341	Resistor, Thin Film, 1M5, 0.1%, ±25ppm, 1/4W, 2010	MC010382
Resistor, Thin Film, 422K, 0.1%, ±25ppm, 1/4W, 2010	MC010342	Resistor, Thin Film, 1M6, 0.1%, ±25ppm, 1/4W, 2010	MC010383
Resistor, Thin Film, 432K, 0.1%, ±25ppm, 1/4W, 2010	MC010343	Resistor, Thin Film, 1M8, 0.1%, ±25ppm, 1/4W, 2010	MC010384
Resistor, Thin Film, 442K, 0.1%, ±25ppm, 1/4W, 2010	MC010344	Resistor, Thin Film, 2M, 0.1%, ±25ppm, 1/4W, 2010	MC010385
Resistor, Thin Film, 453K, 0.1%, ±25ppm, 1/4W, 2010	MC010345	Resistor, Thin Film, 2M4, 0.1%, ±25ppm, 1/4W, 2010	MC010386
Resistor, Thin Film, 464K, 0.1%, ±25ppm, 1/4W, 2010	MC010346	Resistor, Thin Film, 2M7, 0.1%, ±25ppm, 1/4W, 2010	MC010387
Resistor, Thin Film, 475K, 0.1%, ±25ppm, 1/4W, 2010	MC010347	Resistor, Thin Film, 3M, 0.1%, ±25ppm, 1/4W, 2010	MC010388
Resistor, Thin Film, 487K, 0.1%, ±25ppm, 1/4W, 2010	MC010348	Resistor, Thin Film, 4R7, 0.1%, ±25ppm, 1/2W, 2512	MC010389
Resistor, Thin Film, 499K, 0.1%, ±25ppm, 1/4W, 2010	MC010349	Resistor, Thin Film, 5R1, 0.1%, ±25ppm, 1/2W, 2512	MC010390
Resistor, Thin Film, 511K, 0.1%, ±25ppm, 1/4W, 2010	MC010350	Resistor, Thin Film, 5R6, 0.1%, ±25ppm, 1/2W, 2512	MC010391
Resistor, Thin Film, 523K, 0.1%, ±25ppm, 1/4W, 2010	MC010351	Resistor, Thin Film, 6R2, 0.1%, ±25ppm, 1/2W, 2512	MC010392
Resistor, Thin Film, 536K, 0.1%, ±25ppm, 1/4W, 2010	MC010352	Resistor, Thin Film, 6R8, 0.1%, ±25ppm, 1/2W, 2512	MC010393
Resistor, Thin Film, 549K, 0.1%, ±25ppm, 1/4W, 2010	MC010353	Resistor, Thin Film, 7R5, 0.1%, ±25ppm, 1/2W, 2512	MC010394
Resistor, Thin Film, 562K, 0.1%, ±25ppm, 1/4W, 2010	MC010354	Resistor, Thin Film, 8R2, 0.1%, ±25ppm, 1/2W, 2512	MC010395
Resistor, Thin Film, 576K, 0.1%, ±25ppm, 1/4W, 2010	MC010355	Resistor, Thin Film, 9R1, 0.1%, ±25ppm, 1/2W, 2512	MC010396
Resistor, Thin Film, 590K, 0.1%, ±25ppm, 1/4W, 2010	MC010356	Resistor, Thin Film, 10R, 0.1%, ±25ppm, 1/2W, 2512	MC010397
Resistor, Thin Film, 604K, 0.1%, ±25ppm, 1/4W, 2010	MC010357	Resistor, Thin Film, 10R2, 0.1%, ±25ppm, 1/2W, 2512	MC010398
Resistor, Thin Film, 619K, 0.1%, ±25ppm, 1/4W, 2010	MC010358	Resistor, Thin Film, 10R5, 0.1%, ±25ppm, 1/2W, 2512	MC010399
Resistor, Thin Film, 634K, 0.1%, ±25ppm, 1/4W, 2010	MC010359	Resistor, Thin Film, 10R7, 0.1%, ±25ppm, 1/2W, 2512	MC010400
Resistor, Thin Film, 649K, 0.1%, ±25ppm, 1/4W, 2010	MC010360	Resistor, Thin Film, 11R, 0.1%, ±25ppm, 1/2W, 2512	MC010401
Resistor, Thin Film, 665K, 0.1%, ±25ppm, 1/4W, 2010	MC010361	Resistor, Thin Film, 11R3, 0.1%, ±25ppm, 1/2W, 2512	MC010402
Resistor, Thin Film, 681K, 0.1%, ±25ppm, 1/4W, 2010	MC010362	Resistor, Thin Film, 11R5, 0.1%, ±25ppm, 1/2W, 2512	MC010403

www.element14.com
www.farnell.com
www.newark.com



Thin Film Precision Chip Resistor

Description	Part Number	Description	Part Number
Resistor, Thin Film, 11R8, 0.1%, ±25ppm, 1/2W, 2512	MC010404	Resistor, Thin Film, 34R, 0.1%, ±25ppm, 1/2W, 2512	MC010445
Resistor, Thin Film, 12R1, 0.1%, ±25ppm, 1/2W, 2512	MC010405	Resistor, Thin Film, 34R8, 0.1%, ±25ppm, 1/2W, 2512	MC010446
Resistor, Thin Film, 12R4, 0.1%, ±25ppm, 1/2W, 2512	MC010406	Resistor, Thin Film, 35R7, 0.1%, ±25ppm, 1/2W, 2512	MC010447
Resistor, Thin Film, 12R7, 0.1%, ±25ppm, 1/2W, 2512	MC010407	Resistor, Thin Film, 36R5, 0.1%, ±25ppm, 1/2W, 2512	MC010448
Resistor, Thin Film, 13R, 0.1%, ±25ppm, 1/2W, 2512	MC010408	Resistor, Thin Film, 37R4, 0.1%, ±25ppm, 1/2W, 2512	MC010449
Resistor, Thin Film, 13R3, 0.1%, ±25ppm, 1/2W, 2512	MC010409	Resistor, Thin Film, 38R3, 0.1%, ±25ppm, 1/2W, 2512	MC010450
Resistor, Thin Film, 13R7, 0.1%, ±25ppm, 1/2W, 2512	MC010410	Resistor, Thin Film, 39R2, 0.1%, ±25ppm, 1/2W, 2512	MC010451
Resistor, Thin Film, 14R, 0.1%, ±25ppm, 1/2W, 2512	MC010411	Resistor, Thin Film, 40R2, 0.1%, ±25ppm, 1/2W, 2512	MC010452
Resistor, Thin Film, 14R3, 0.1%, ±25ppm, 1/2W, 2512	MC010412	Resistor, Thin Film, 41R2, 0.1%, ±25ppm, 1/2W, 2512	MC010453
Resistor, Thin Film, 14R7, 0.1%, ±25ppm, 1/2W, 2512	MC010413	Resistor, Thin Film, 42R2, 0.1%, ±25ppm, 1/2W, 2512	MC010454
Resistor, Thin Film, 15R, 0.1%, ±25ppm, 1/2W, 2512	MC010414	Resistor, Thin Film, 43R2, 0.1%, ±25ppm, 1/2W, 2512	MC010455
Resistor, Thin Film, 15R4, 0.1%, ±25ppm, 1/2W, 2512	MC010415	Resistor, Thin Film, 44R2, 0.1%, ±25ppm, 1/2W, 2512	MC010456
Resistor, Thin Film, 15R8, 0.1%, ±25ppm, 1/2W, 2512	MC010416	Resistor, Thin Film, 45R3, 0.1%, ±25ppm, 1/2W, 2512	MC010457
Resistor, Thin Film, 16R2, 0.1%, ±25ppm, 1/2W, 2512	MC010417	Resistor, Thin Film, 46R4, 0.1%, ±25ppm, 1/2W, 2512	MC010458
Resistor, Thin Film, 16R5, 0.1%, ±25ppm, 1/2W, 2512	MC010418	Resistor, Thin Film, 47R5, 0.1%, ±25ppm, 1/2W, 2512	MC010459
Resistor, Thin Film, 16R9, 0.1%, ±25ppm, 1/2W, 2512	MC010419	Resistor, Thin Film, 48R7, 0.1%, ±25ppm, 1/2W, 2512	MC010460
Resistor, Thin Film, 17R4, 0.1%, ±25ppm, 1/2W, 2512	MC010420	Resistor, Thin Film, 49R9, 0.1%, ±25ppm, 1/2W, 2512	MC010461
Resistor, Thin Film, 17R8, 0.1%, ±25ppm, 1/2W, 2512	MC010421	Resistor, Thin Film, 51R1, 0.1%, ±25ppm, 1/2W, 2512	MC010462
Resistor, Thin Film, 18R2, 0.1%, ±25ppm, 1/2W, 2512	MC010422	Resistor, Thin Film, 52R3, 0.1%, ±25ppm, 1/2W, 2512	MC010463
Resistor, Thin Film, 18R7, 0.1%, ±25ppm, 1/2W, 2512	MC010423	Resistor, Thin Film, 53R6, 0.1%, ±25ppm, 1/2W, 2512	MC010464
Resistor, Thin Film, 19R1, 0.1%, ±25ppm, 1/2W, 2512	MC010424	Resistor, Thin Film, 54R9, 0.1%, ±25ppm, 1/2W, 2512	MC010465
Resistor, Thin Film, 19R6, 0.1%, ±25ppm, 1/2W, 2512	MC010425	Resistor, Thin Film, 56R2, 0.1%, ±25ppm, 1/2W, 2512	MC010466
Resistor, Thin Film, 20R, 0.1%, ±25ppm, 1/2W, 2512	MC010426	Resistor, Thin Film, 57R6, 0.1%, ±25ppm, 1/2W, 2512	MC010467
Resistor, Thin Film, 20R5, 0.1%, ±25ppm, 1/2W, 2512	MC010427	Resistor, Thin Film, 59R, 0.1%, ±25ppm, 1/2W, 2512	MC010468
Resistor, Thin Film, 21R, 0.1%, ±25ppm, 1/2W, 2512	MC010428	Resistor, Thin Film, 60R4, 0.1%, ±25ppm, 1/2W, 2512	MC010469
Resistor, Thin Film, 21R5, 0.1%, ±25ppm, 1/2W, 2512	MC010429	Resistor, Thin Film, 61R9, 0.1%, ±25ppm, 1/2W, 2512	MC010470
Resistor, Thin Film, 22R1, 0.1%, ±25ppm, 1/2W, 2512	MC010430	Resistor, Thin Film, 63R4, 0.1%, ±25ppm, 1/2W, 2512	MC010471
Resistor, Thin Film, 22R6, 0.1%, ±25ppm, 1/2W, 2512	MC010431	Resistor, Thin Film, 64R9, 0.1%, ±25ppm, 1/2W, 2512	MC010472
Resistor, Thin Film, 23R2, 0.1%, ±25ppm, 1/2W, 2512	MC010432	Resistor, Thin Film, 66R5, 0.1%, ±25ppm, 1/2W, 2512	MC010473
Resistor, Thin Film, 23R7, 0.1%, ±25ppm, 1/2W, 2512	MC010433	Resistor, Thin Film, 68R1, 0.1%, ±25ppm, 1/2W, 2512	MC010474
Resistor, Thin Film, 24R3, 0.1%, ±25ppm, 1/2W, 2512	MC010434	Resistor, Thin Film, 69R8, 0.1%, ±25ppm, 1/2W, 2512	MC010475
Resistor, Thin Film, 24R9, 0.1%, ±25ppm, 1/2W, 2512	MC010435	Resistor, Thin Film, 71R5, 0.1%, ±25ppm, 1/2W, 2512	MC010476
Resistor, Thin Film, 25R5, 0.1%, ±25ppm, 1/2W, 2512	MC010436	Resistor, Thin Film, 73R2, 0.1%, ±25ppm, 1/2W, 2512	MC010477
Resistor, Thin Film, 26R1, 0.1%, ±25ppm, 1/2W, 2512	MC010437	Resistor, Thin Film, 75R, 0.1%, ±25ppm, 1/2W, 2512	MC010478
Resistor, Thin Film, 26R7, 0.1%, ±25ppm, 1/2W, 2512	MC010438	Resistor, Thin Film, 76R8, 0.1%, ±25ppm, 1/2W, 2512	MC010479
Resistor, Thin Film, 27R4, 0.1%, ±25ppm, 1/2W, 2512	MC010439	Resistor, Thin Film, 78R7, 0.1%, ±25ppm, 1/2W, 2512	MC010480
Resistor, Thin Film, 28R, 0.1%, ±25ppm, 1/2W, 2512	MC010440	Resistor, Thin Film, 80R6, 0.1%, ±25ppm, 1/2W, 2512	MC010481
Resistor, Thin Film, 29R4, 0.1%, ±25ppm, 1/2W, 2512	MC010441	Resistor, Thin Film, 82R5, 0.1%, ±25ppm, 1/2W, 2512	MC010482
Resistor, Thin Film, 31R6, 0.1%, ±25ppm, 1/2W, 2512	MC010442	Resistor, Thin Film, 84R5, 0.1%, ±25ppm, 1/2W, 2512	MC010483
Resistor, Thin Film, 32R4, 0.1%, ±25ppm, 1/2W, 2512	MC010443	Resistor, Thin Film, 86R6, 0.1%, ±25ppm, 1/2W, 2512	MC010484
Resistor, Thin Film, 33R2, 0.1%, ±25ppm, 1/2W, 2512	MC010444	Resistor, Thin Film, 88R7, 0.1%, ±25ppm, 1/2W, 2512	MC010485

www.element14.com
www.farnell.com
www.newark.com



Thin Film Precision Chip Resistor

Description	Part Number	Description	Part Number
Resistor, Thin Film, 698R, 0.1%, ±25ppm, 1/2W, 2512	MC010568	Resistor, Thin Film, 1K87, 0.1%, ±25ppm, 1/2W, 2512	MC010609
Resistor, Thin Film, 715R, 0.1%, ±25ppm, 1/2W, 2512	MC010569	Resistor, Thin Film, 1K91, 0.1%, ±25ppm, 1/2W, 2512	MC010610
Resistor, Thin Film, 732R, 0.1%, ±25ppm, 1/2W, 2512	MC010570	Resistor, Thin Film, 1K96, 0.1%, ±25ppm, 1/2W, 2512	MC010611
Resistor, Thin Film, 750R, 0.1%, ±25ppm, 1/2W, 2512	MC010571	Resistor, Thin Film, 2K, 0.1%, ±25ppm, 1/2W, 2512	MC010612
Resistor, Thin Film, 768R, 0.1%, ±25ppm, 1/2W, 2512	MC010572	Resistor, Thin Film, 2K05, 0.1%, ±25ppm, 1/2W, 2512	MC010613
Resistor, Thin Film, 787R, 0.1%, ±25ppm, 1/2W, 2512	MC010573	Resistor, Thin Film, 2K1, 0.1%, ±25ppm, 1/2W, 2512	MC010614
Resistor, Thin Film, 806R, 0.1%, ±25ppm, 1/2W, 2512	MC010574	Resistor, Thin Film, 2K15, 0.1%, ±25ppm, 1/2W, 2512	MC010615
Resistor, Thin Film, 825R, 0.1%, ±25ppm, 1/2W, 2512	MC010575	Resistor, Thin Film, 2K21, 0.1%, ±25ppm, 1/2W, 2512	MC010616
Resistor, Thin Film, 845R, 0.1%, ±25ppm, 1/2W, 2512	MC010576	Resistor, Thin Film, 2K26, 0.1%, ±25ppm, 1/2W, 2512	MC010617
Resistor, Thin Film, 866R, 0.1%, ±25ppm, 1/2W, 2512	MC010577	Resistor, Thin Film, 2K32, 0.1%, ±25ppm, 1/2W, 2512	MC010618
Resistor, Thin Film, 887R, 0.1%, ±25ppm, 1/2W, 2512	MC010578	Resistor, Thin Film, 2K37, 0.1%, ±25ppm, 1/2W, 2512	MC010619
Resistor, Thin Film, 909R, 0.1%, ±25ppm, 1/2W, 2512	MC010579	Resistor, Thin Film, 2K43, 0.1%, ±25ppm, 1/2W, 2512	MC010620
Resistor, Thin Film, 931R, 0.1%, ±25ppm, 1/2W, 2512	MC010580	Resistor, Thin Film, 2K49, 0.1%, ±25ppm, 1/2W, 2512	MC010621
Resistor, Thin Film, 953R, 0.1%, ±25ppm, 1/2W, 2512	MC010581	Resistor, Thin Film, 2K55, 0.1%, ±25ppm, 1/2W, 2512	MC010622
Resistor, Thin Film, 976R, 0.1%, ±25ppm, 1/2W, 2512	MC010582	Resistor, Thin Film, 2K61, 0.1%, ±25ppm, 1/2W, 2512	MC010623
Resistor, Thin Film, 1K, 0.1%, ±25ppm, 1/2W, 2512	MC010583	Resistor, Thin Film, 2K67, 0.1%, ±25ppm, 1/2W, 2512	MC010624
Resistor, Thin Film, 1K02, 0.1%, ±25ppm, 1/2W, 2512	MC010584	Resistor, Thin Film, 2K74, 0.1%, ±25ppm, 1/2W, 2512	MC010625
Resistor, Thin Film, 1K05, 0.1%, ±25ppm, 1/2W, 2512	MC010585	Resistor, Thin Film, 2K8, 0.1%, ±25ppm, 1/2W, 2512	MC010626
Resistor, Thin Film, 1K07, 0.1%, ±25ppm, 1/2W, 2512	MC010586	Resistor, Thin Film, 2K94, 0.1%, ±25ppm, 1/2W, 2512	MC010627
Resistor, Thin Film, 1K1, 0.1%, ±25ppm, 1/2W, 2512	MC010587	Resistor, Thin Film, 3K16, 0.1%, ±25ppm, 1/2W, 2512	MC010628
Resistor, Thin Film, 1K13, 0.1%, ±25ppm, 1/2W, 2512	MC010588	Resistor, Thin Film, 3K24, 0.1%, ±25ppm, 1/2W, 2512	MC010629
Resistor, Thin Film, 1K15, 0.1%, ±25ppm, 1/2W, 2512	MC010589	Resistor, Thin Film, 3K32, 0.1%, ±25ppm, 1/2W, 2512	MC010630
Resistor, Thin Film, 1K18, 0.1%, ±25ppm, 1/2W, 2512	MC010590	Resistor, Thin Film, 3K4, 0.1%, ±25ppm, 1/2W, 2512	MC010631
Resistor, Thin Film, 1K21, 0.1%, ±25ppm, 1/2W, 2512	MC010591	Resistor, Thin Film, 3K48, 0.1%, ±25ppm, 1/2W, 2512	MC010632
Resistor, Thin Film, 1K24, 0.1%, ±25ppm, 1/2W, 2512	MC010592	Resistor, Thin Film, 3K57, 0.1%, ±25ppm, 1/2W, 2512	MC010633
Resistor, Thin Film, 1K27, 0.1%, ±25ppm, 1/2W, 2512	MC010593	Resistor, Thin Film, 3K65, 0.1%, ±25ppm, 1/2W, 2512	MC010634
Resistor, Thin Film, 1K3, 0.1%, ±25ppm, 1/2W, 2512	MC010594	Resistor, Thin Film, 3K74, 0.1%, ±25ppm, 1/2W, 2512	MC010635
Resistor, Thin Film, 1K33, 0.1%, ±25ppm, 1/2W, 2512	MC010595	Resistor, Thin Film, 3K83, 0.1%, ±25ppm, 1/2W, 2512	MC010636
Resistor, Thin Film, 1K37, 0.1%, ±25ppm, 1/2W, 2512	MC010596	Resistor, Thin Film, 3K92, 0.1%, ±25ppm, 1/2W, 2512	MC010637
Resistor, Thin Film, 1K4, 0.1%, ±25ppm, 1/2W, 2512	MC010597	Resistor, Thin Film, 4K02, 0.1%, ±25ppm, 1/2W, 2512	MC010638
Resistor, Thin Film, 1K43, 0.1%, ±25ppm, 1/2W, 2512	MC010598	Resistor, Thin Film, 4K12, 0.1%, ±25ppm, 1/2W, 2512	MC010639
Resistor, Thin Film, 1K47, 0.1%, ±25ppm, 1/2W, 2512	MC010599	Resistor, Thin Film, 4K22, 0.1%, ±25ppm, 1/2W, 2512	MC010640
Resistor, Thin Film, 1K5, 0.1%, ±25ppm, 1/2W, 2512	MC010600	Resistor, Thin Film, 4K32, 0.1%, ±25ppm, 1/2W, 2512	MC010641
Resistor, Thin Film, 1K54, 0.1%, ±25ppm, 1/2W, 2512	MC010601	Resistor, Thin Film, 4K42, 0.1%, ±25ppm, 1/2W, 2512	MC010642
Resistor, Thin Film, 1K58, 0.1%, ±25ppm, 1/2W, 2512	MC010602	Resistor, Thin Film, 4K53, 0.1%, ±25ppm, 1/2W, 2512	MC010643
Resistor, Thin Film, 1K62, 0.1%, ±25ppm, 1/2W, 2512	MC010603	Resistor, Thin Film, 4K64, 0.1%, ±25ppm, 1/2W, 2512	MC010644
Resistor, Thin Film, 1K65, 0.1%, ±25ppm, 1/2W, 2512	MC010604	Resistor, Thin Film, 4K75, 0.1%, ±25ppm, 1/2W, 2512	MC010645
Resistor, Thin Film, 1K69, 0.1%, ±25ppm, 1/2W, 2512	MC010605	Resistor, Thin Film, 4K87, 0.1%, ±25ppm, 1/2W, 2512	MC010646
Resistor, Thin Film, 1K74, 0.1%, ±25ppm, 1/2W, 2512	MC010606	Resistor, Thin Film, 4K99, 0.1%, ±25ppm, 1/2W, 2512	MC010647
Resistor, Thin Film, 1K78, 0.1%, ±25ppm, 1/2W, 2512	MC010607	Resistor, Thin Film, 5K11, 0.1%, ±25ppm, 1/2W, 2512	MC010648
Resistor, Thin Film, 1K82, 0.1%, ±25ppm, 1/2W, 2512	MC010608	Resistor, Thin Film, 5K23, 0.1%, ±25ppm, 1/2W, 2512	MC010649

www.element14.com
www.farnell.com
www.newark.com



Thin Film Precision Chip Resistor

Description	Part Number	Description	Part Number
Resistor, Thin Film, 5K36, 0.1%, ±25ppm, 1/2W, 2512	MC010650	Resistor, Thin Film, 14K3, 0.1%, ±25ppm, 1/2W, 2512	MC010691
Resistor, Thin Film, 5K49, 0.1%, ±25ppm, 1/2W, 2512	MC010651	Resistor, Thin Film, 14K7, 0.1%, ±25ppm, 1/2W, 2512	MC010692
Resistor, Thin Film, 5K62, 0.1%, ±25ppm, 1/2W, 2512	MC010652	Resistor, Thin Film, 15K, 0.1%, ±25ppm, 1/2W, 2512	MC010693
Resistor, Thin Film, 5K76, 0.1%, ±25ppm, 1/2W, 2512	MC010653	Resistor, Thin Film, 15K4, 0.1%, ±25ppm, 1/2W, 2512	MC010694
Resistor, Thin Film, 5K9, 0.1%, ±25ppm, 1/2W, 2512	MC010654	Resistor, Thin Film, 15K8, 0.1%, ±25ppm, 1/2W, 2512	MC010695
Resistor, Thin Film, 6K04, 0.1%, ±25ppm, 1/2W, 2512	MC010655	Resistor, Thin Film, 16K2, 0.1%, ±25ppm, 1/2W, 2512	MC010696
Resistor, Thin Film, 6K19, 0.1%, ±25ppm, 1/2W, 2512	MC010656	Resistor, Thin Film, 16K5, 0.1%, ±25ppm, 1/2W, 2512	MC010697
Resistor, Thin Film, 6K34, 0.1%, ±25ppm, 1/2W, 2512	MC010657	Resistor, Thin Film, 16K9, 0.1%, ±25ppm, 1/2W, 2512	MC010698
Resistor, Thin Film, 6K49, 0.1%, ±25ppm, 1/2W, 2512	MC010658	Resistor, Thin Film, 17K4, 0.1%, ±25ppm, 1/2W, 2512	MC010699
Resistor, Thin Film, 6K65, 0.1%, ±25ppm, 1/2W, 2512	MC010659	Resistor, Thin Film, 17K8, 0.1%, ±25ppm, 1/2W, 2512	MC010700
Resistor, Thin Film, 6K81, 0.1%, ±25ppm, 1/2W, 2512	MC010660	Resistor, Thin Film, 18K2, 0.1%, ±25ppm, 1/2W, 2512	MC010701
Resistor, Thin Film, 6K98, 0.1%, ±25ppm, 1/2W, 2512	MC010661	Resistor, Thin Film, 18K7, 0.1%, ±25ppm, 1/2W, 2512	MC010702
Resistor, Thin Film, 7K15, 0.1%, ±25ppm, 1/2W, 2512	MC010662	Resistor, Thin Film, 19K1, 0.1%, ±25ppm, 1/2W, 2512	MC010703
Resistor, Thin Film, 7K32, 0.1%, ±25ppm, 1/2W, 2512	MC010663	Resistor, Thin Film, 19K6, 0.1%, ±25ppm, 1/2W, 2512	MC010704
Resistor, Thin Film, 7K5, 0.1%, ±25ppm, 1/2W, 2512	MC010664	Resistor, Thin Film, 20K, 0.1%, ±25ppm, 1/2W, 2512	MC010705
Resistor, Thin Film, 7K68, 0.1%, ±25ppm, 1/2W, 2512	MC010665	Resistor, Thin Film, 20K5, 0.1%, ±25ppm, 1/2W, 2512	MC010706
Resistor, Thin Film, 7K87, 0.1%, ±25ppm, 1/2W, 2512	MC010666	Resistor, Thin Film, 21K, 0.1%, ±25ppm, 1/2W, 2512	MC010707
Resistor, Thin Film, 8K06, 0.1%, ±25ppm, 1/2W, 2512	MC010667	Resistor, Thin Film, 21K5, 0.1%, ±25ppm, 1/2W, 2512	MC010708
Resistor, Thin Film, 8K25, 0.1%, ±25ppm, 1/2W, 2512	MC010668	Resistor, Thin Film, 22K1, 0.1%, ±25ppm, 1/2W, 2512	MC010709
Resistor, Thin Film, 8K45, 0.1%, ±25ppm, 1/2W, 2512	MC010669	Resistor, Thin Film, 22K6, 0.1%, ±25ppm, 1/2W, 2512	MC010710
Resistor, Thin Film, 8K66, 0.1%, ±25ppm, 1/2W, 2512	MC010670	Resistor, Thin Film, 23K2, 0.1%, ±25ppm, 1/2W, 2512	MC010711
Resistor, Thin Film, 8K87, 0.1%, ±25ppm, 1/2W, 2512	MC010671	Resistor, Thin Film, 23K7, 0.1%, ±25ppm, 1/2W, 2512	MC010712
Resistor, Thin Film, 9K09, 0.1%, ±25ppm, 1/2W, 2512	MC010672	Resistor, Thin Film, 24K3, 0.1%, ±25ppm, 1/2W, 2512	MC010713
Resistor, Thin Film, 9K31, 0.1%, ±25ppm, 1/2W, 2512	MC010673	Resistor, Thin Film, 24K9, 0.1%, ±25ppm, 1/2W, 2512	MC010714
Resistor, Thin Film, 9K53, 0.1%, ±25ppm, 1/2W, 2512	MC010674	Resistor, Thin Film, 25K5, 0.1%, ±25ppm, 1/2W, 2512	MC010715
Resistor, Thin Film, 9K76, 0.1%, ±25ppm, 1/2W, 2512	MC010675	Resistor, Thin Film, 26K1, 0.1%, ±25ppm, 1/2W, 2512	MC010716
Resistor, Thin Film, 10K, 0.1%, ±25ppm, 1/2W, 2512	MC010676	Resistor, Thin Film, 26K7, 0.1%, ±25ppm, 1/2W, 2512	MC010717
Resistor, Thin Film, 10K2, 0.1%, ±25ppm, 1/2W, 2512	MC010677	Resistor, Thin Film, 27K4, 0.1%, ±25ppm, 1/2W, 2512	MC010718
Resistor, Thin Film, 10K5, 0.1%, ±25ppm, 1/2W, 2512	MC010678	Resistor, Thin Film, 28K, 0.1%, ±25ppm, 1/2W, 2512	MC010719
Resistor, Thin Film, 10K7, 0.1%, ±25ppm, 1/2W, 2512	MC010679	Resistor, Thin Film, 29K4, 0.1%, ±25ppm, 1/2W, 2512	MC010720
Resistor, Thin Film, 11K, 0.1%, ±25ppm, 1/2W, 2512	MC010680	Resistor, Thin Film, 31K6, 0.1%, ±25ppm, 1/2W, 2512	MC010721
Resistor, Thin Film, 11K3, 0.1%, ±25ppm, 1/2W, 2512	MC010681	Resistor, Thin Film, 32K4, 0.1%, ±25ppm, 1/2W, 2512	MC010722
Resistor, Thin Film, 11K5, 0.1%, ±25ppm, 1/2W, 2512	MC010682	Resistor, Thin Film, 33K2, 0.1%, ±25ppm, 1/2W, 2512	MC010723
Resistor, Thin Film, 11K8, 0.1%, ±25ppm, 1/2W, 2512	MC010683	Resistor, Thin Film, 34K, 0.1%, ±25ppm, 1/2W, 2512	MC010724
Resistor, Thin Film, 12K1, 0.1%, ±25ppm, 1/2W, 2512	MC010684	Resistor, Thin Film, 34K8, 0.1%, ±25ppm, 1/2W, 2512	MC010725
Resistor, Thin Film, 12K4, 0.1%, ±25ppm, 1/2W, 2512	MC010685	Resistor, Thin Film, 35K7, 0.1%, ±25ppm, 1/2W, 2512	MC010726
Resistor, Thin Film, 12K7, 0.1%, ±25ppm, 1/2W, 2512	MC010686	Resistor, Thin Film, 36K5, 0.1%, ±25ppm, 1/2W, 2512	MC010727
Resistor, Thin Film, 13K, 0.1%, ±25ppm, 1/2W, 2512	MC010687	Resistor, Thin Film, 37K4, 0.1%, ±25ppm, 1/2W, 2512	MC010728
Resistor, Thin Film, 13K3, 0.1%, ±25ppm, 1/2W, 2512	MC010688	Resistor, Thin Film, 38K3, 0.1%, ±25ppm, 1/2W, 2512	MC010729
Resistor, Thin Film, 13K7, 0.1%, ±25ppm, 1/2W, 2512	MC010689	Resistor, Thin Film, 39K2, 0.1%, ±25ppm, 1/2W, 2512	MC010730
Resistor, Thin Film, 14K, 0.1%, ±25ppm, 1/2W, 2512	MC010690	Resistor, Thin Film, 40K2, 0.1%, ±25ppm, 1/2W, 2512	MC010731

www.element14.com
www.farnell.com
www.newark.com



Thin Film Precision Chip Resistor

Description	Part Number	Description	Part Number
Resistor, Thin Film, 41K2, 0.1%, ±25ppm, 1/2W, 2512	MC010732	Resistor, Thin Film, 110K, 0.1%, ±25ppm, 1/2W, 2512	MC010773
Resistor, Thin Film, 42K2, 0.1%, ±25ppm, 1/2W, 2512	MC010733	Resistor, Thin Film, 113K, 0.1%, ±25ppm, 1/2W, 2512	MC010774
Resistor, Thin Film, 43K2, 0.1%, ±25ppm, 1/2W, 2512	MC010734	Resistor, Thin Film, 115K, 0.1%, ±25ppm, 1/2W, 2512	MC010775
Resistor, Thin Film, 44K2, 0.1%, ±25ppm, 1/2W, 2512	MC010735	Resistor, Thin Film, 118K, 0.1%, ±25ppm, 1/2W, 2512	MC010776
Resistor, Thin Film, 45K3, 0.1%, ±25ppm, 1/2W, 2512	MC010736	Resistor, Thin Film, 121K, 0.1%, ±25ppm, 1/2W, 2512	MC010777
Resistor, Thin Film, 46K4, 0.1%, ±25ppm, 1/2W, 2512	MC010737	Resistor, Thin Film, 124K, 0.1%, ±25ppm, 1/2W, 2512	MC010778
Resistor, Thin Film, 47K5, 0.1%, ±25ppm, 1/2W, 2512	MC010738	Resistor, Thin Film, 127K, 0.1%, ±25ppm, 1/2W, 2512	MC010779
Resistor, Thin Film, 48K7, 0.1%, ±25ppm, 1/2W, 2512	MC010739	Resistor, Thin Film, 130K, 0.1%, ±25ppm, 1/2W, 2512	MC010780
Resistor, Thin Film, 49K9, 0.1%, ±25ppm, 1/2W, 2512	MC010740	Resistor, Thin Film, 133K, 0.1%, ±25ppm, 1/2W, 2512	MC010781
Resistor, Thin Film, 51K1, 0.1%, ±25ppm, 1/2W, 2512	MC010741	Resistor, Thin Film, 137K, 0.1%, ±25ppm, 1/2W, 2512	MC010782
Resistor, Thin Film, 52K3, 0.1%, ±25ppm, 1/2W, 2512	MC010742	Resistor, Thin Film, 140K, 0.1%, ±25ppm, 1/2W, 2512	MC010783
Resistor, Thin Film, 53K6, 0.1%, ±25ppm, 1/2W, 2512	MC010743	Resistor, Thin Film, 143K, 0.1%, ±25ppm, 1/2W, 2512	MC010784
Resistor, Thin Film, 54K9, 0.1%, ±25ppm, 1/2W, 2512	MC010744	Resistor, Thin Film, 147K, 0.1%, ±25ppm, 1/2W, 2512	MC010785
Resistor, Thin Film, 56K2, 0.1%, ±25ppm, 1/2W, 2512	MC010745	Resistor, Thin Film, 150K, 0.1%, ±25ppm, 1/2W, 2512	MC010786
Resistor, Thin Film, 57K6, 0.1%, ±25ppm, 1/2W, 2512	MC010746	Resistor, Thin Film, 154K, 0.1%, ±25ppm, 1/2W, 2512	MC010787
Resistor, Thin Film, 59K, 0.1%, ±25ppm, 1/2W, 2512	MC010747	Resistor, Thin Film, 158K, 0.1%, ±25ppm, 1/2W, 2512	MC010788
Resistor, Thin Film, 60K4, 0.1%, ±25ppm, 1/2W, 2512	MC010748	Resistor, Thin Film, 162K, 0.1%, ±25ppm, 1/2W, 2512	MC010789
Resistor, Thin Film, 61K9, 0.1%, ±25ppm, 1/2W, 2512	MC010749	Resistor, Thin Film, 165K, 0.1%, ±25ppm, 1/2W, 2512	MC010790
Resistor, Thin Film, 63K4, 0.1%, ±25ppm, 1/2W, 2512	MC010750	Resistor, Thin Film, 169K, 0.1%, ±25ppm, 1/2W, 2512	MC010791
Resistor, Thin Film, 64K9, 0.1%, ±25ppm, 1/2W, 2512	MC010751	Resistor, Thin Film, 174K, 0.1%, ±25ppm, 1/2W, 2512	MC010792
Resistor, Thin Film, 66K5, 0.1%, ±25ppm, 1/2W, 2512	MC010752	Resistor, Thin Film, 178K, 0.1%, ±25ppm, 1/2W, 2512	MC010793
Resistor, Thin Film, 68K1, 0.1%, ±25ppm, 1/2W, 2512	MC010753	Resistor, Thin Film, 182K, 0.1%, ±25ppm, 1/2W, 2512	MC010794
Resistor, Thin Film, 69K8, 0.1%, ±25ppm, 1/2W, 2512	MC010754	Resistor, Thin Film, 187K, 0.1%, ±25ppm, 1/2W, 2512	MC010795
Resistor, Thin Film, 71K5, 0.1%, ±25ppm, 1/2W, 2512	MC010755	Resistor, Thin Film, 191K, 0.1%, ±25ppm, 1/2W, 2512	MC010796
Resistor, Thin Film, 73K2, 0.1%, ±25ppm, 1/2W, 2512	MC010756	Resistor, Thin Film, 196K, 0.1%, ±25ppm, 1/2W, 2512	MC010797
Resistor, Thin Film, 75K, 0.1%, ±25ppm, 1/2W, 2512	MC010757	Resistor, Thin Film, 200K, 0.1%, ±25ppm, 1/2W, 2512	MC010798
Resistor, Thin Film, 76K8, 0.1%, ±25ppm, 1/2W, 2512	MC010758	Resistor, Thin Film, 205K, 0.1%, ±25ppm, 1/2W, 2512	MC010799
Resistor, Thin Film, 78K7, 0.1%, ±25ppm, 1/2W, 2512	MC010759	Resistor, Thin Film, 210K, 0.1%, ±25ppm, 1/2W, 2512	MC010800
Resistor, Thin Film, 80K6, 0.1%, ±25ppm, 1/2W, 2512	MC010760	Resistor, Thin Film, 215K, 0.1%, ±25ppm, 1/2W, 2512	MC010801
Resistor, Thin Film, 82K5, 0.1%, ±25ppm, 1/2W, 2512	MC010761	Resistor, Thin Film, 221K, 0.1%, ±25ppm, 1/2W, 2512	MC010802
Resistor, Thin Film, 84K5, 0.1%, ±25ppm, 1/2W, 2512	MC010762	Resistor, Thin Film, 226K, 0.1%, ±25ppm, 1/2W, 2512	MC010803
Resistor, Thin Film, 86K6, 0.1%, ±25ppm, 1/2W, 2512	MC010763	Resistor, Thin Film, 232K, 0.1%, ±25ppm, 1/2W, 2512	MC010804
Resistor, Thin Film, 88K7, 0.1%, ±25ppm, 1/2W, 2512	MC010764	Resistor, Thin Film, 237K, 0.1%, ±25ppm, 1/2W, 2512	MC010805
Resistor, Thin Film, 90K9, 0.1%, ±25ppm, 1/2W, 2512	MC010765	Resistor, Thin Film, 243K, 0.1%, ±25ppm, 1/2W, 2512	MC010806
Resistor, Thin Film, 93K1, 0.1%, ±25ppm, 1/2W, 2512	MC010766	Resistor, Thin Film, 249K, 0.1%, ±25ppm, 1/2W, 2512	MC010807
Resistor, Thin Film, 95K3, 0.1%, ±25ppm, 1/2W, 2512	MC010767	Resistor, Thin Film, 255K, 0.1%, ±25ppm, 1/2W, 2512	MC010808
Resistor, Thin Film, 97K6, 0.1%, ±25ppm, 1/2W, 2512	MC010768	Resistor, Thin Film, 261K, 0.1%, ±25ppm, 1/2W, 2512	MC010809
Resistor, Thin Film, 100K, 0.1%, ±25ppm, 1/2W, 2512	MC010769	Resistor, Thin Film, 267K, 0.1%, ±25ppm, 1/2W, 2512	MC010810
Resistor, Thin Film, 102K, 0.1%, ±25ppm, 1/2W, 2512	MC010770	Resistor, Thin Film, 274K, 0.1%, ±25ppm, 1/2W, 2512	MC010811
Resistor, Thin Film, 105K, 0.1%, ±25ppm, 1/2W, 2512	MC010771	Resistor, Thin Film, 280K, 0.1%, ±25ppm, 1/2W, 2512	MC010812
Resistor, Thin Film, 107K, 0.1%, ±25ppm, 1/2W, 2512	MC010772	Resistor, Thin Film, 294K, 0.1%, ±25ppm, 1/2W, 2512	MC010813

www.element14.com
www.farnell.com
www.newark.com



Thin Film Precision Chip Resistor

Description	Part Number	Description	Part Number
Resistor, Thin Film, 316K, 0.1%, ±25ppm, 1/2W, 2512	MC010814	Resistor, Thin Film, 750K, 0.1%, ±25ppm, 1/2W, 2512	MC010850
Resistor, Thin Film, 324K, 0.1%, ±25ppm, 1/2W, 2512	MC010815	Resistor, Thin Film, 768K, 0.1%, ±25ppm, 1/2W, 2512	MC010851
Resistor, Thin Film, 332K, 0.1%, ±25ppm, 1/2W, 2512	MC010816	Resistor, Thin Film, 787K, 0.1%, ±25ppm, 1/2W, 2512	MC010852
Resistor, Thin Film, 340K, 0.1%, ±25ppm, 1/2W, 2512	MC010817	Resistor, Thin Film, 806K, 0.1%, ±25ppm, 1/2W, 2512	MC010853
Resistor, Thin Film, 348K, 0.1%, ±25ppm, 1/2W, 2512	MC010818	Resistor, Thin Film, 825K, 0.1%, ±25ppm, 1/2W, 2512	MC010854
Resistor, Thin Film, 357K, 0.1%, ±25ppm, 1/2W, 2512	MC010819	Resistor, Thin Film, 845K, 0.1%, ±25ppm, 1/2W, 2512	MC010855
Resistor, Thin Film, 365K, 0.1%, ±25ppm, 1/2W, 2512	MC010820	Resistor, Thin Film, 866K, 0.1%, ±25ppm, 1/2W, 2512	MC010856
Resistor, Thin Film, 374K, 0.1%, ±25ppm, 1/2W, 2512	MC010821	Resistor, Thin Film, 887K, 0.1%, ±25ppm, 1/2W, 2512	MC010857
Resistor, Thin Film, 383K, 0.1%, ±25ppm, 1/2W, 2512	MC010822	Resistor, Thin Film, 909K, 0.1%, ±25ppm, 1/2W, 2512	MC010858
Resistor, Thin Film, 392K, 0.1%, ±25ppm, 1/2W, 2512	MC010823	Resistor, Thin Film, 931K, 0.1%, ±25ppm, 1/2W, 2512	MC010859
Resistor, Thin Film, 402K, 0.1%, ±25ppm, 1/2W, 2512	MC010824	Resistor, Thin Film, 953K, 0.1%, ±25ppm, 1/2W, 2512	MC010860
Resistor, Thin Film, 412K, 0.1%, ±25ppm, 1/2W, 2512	MC010825	Resistor, Thin Film, 976K, 0.1%, ±25ppm, 1/2W, 2512	MC010861
Resistor, Thin Film, 422K, 0.1%, ±25ppm, 1/2W, 2512	MC010826	Resistor, Thin Film, 1M, 0.1%, ±25ppm, 1/2W, 2512	MC010862
Resistor, Thin Film, 432K, 0.1%, ±25ppm, 1/2W, 2512	MC010827	Resistor, Thin Film, 1M1, 0.1%, ±25ppm, 1/2W, 2512	MC010863
Resistor, Thin Film, 442K, 0.1%, ±25ppm, 1/2W, 2512	MC010828	Resistor, Thin Film, 1M2, 0.1%, ±25ppm, 1/2W, 2512	MC010864
Resistor, Thin Film, 453K, 0.1%, ±25ppm, 1/2W, 2512	MC010829	Resistor, Thin Film, 1M3, 0.1%, ±25ppm, 1/2W, 2512	MC010865
Resistor, Thin Film, 464K, 0.1%, ±25ppm, 1/2W, 2512	MC010830	Resistor, Thin Film, 1M5, 0.1%, ±25ppm, 1/2W, 2512	MC010866
Resistor, Thin Film, 475K, 0.1%, ±25ppm, 1/2W, 2512	MC010831	Resistor, Thin Film, 1M6, 0.1%, ±25ppm, 1/2W, 2512	MC010867
Resistor, Thin Film, 487K, 0.1%, ±25ppm, 1/2W, 2512	MC010832	Resistor, Thin Film, 1M8, 0.1%, ±25ppm, 1/2W, 2512	MC010868
Resistor, Thin Film, 499K, 0.1%, ±25ppm, 1/2W, 2512	MC010833	Resistor, Thin Film, 2M, 0.1%, ±25ppm, 1/2W, 2512	MC010869
Resistor, Thin Film, 511K, 0.1%, ±25ppm, 1/2W, 2512	MC010834	Resistor, Thin Film, 2M4, 0.1%, ±25ppm, 1/2W, 2512	MC010870
Resistor, Thin Film, 523K, 0.1%, ±25ppm, 1/2W, 2512	MC010835	Resistor, Thin Film, 2M7, 0.1%, ±25ppm, 1/2W, 2512	MC010871
Resistor, Thin Film, 536K, 0.1%, ±25ppm, 1/2W, 2512	MC010836	Resistor, Thin Film, 3M, 0.1%, ±25ppm, 1/2W, 2512	MC010872
Resistor, Thin Film, 549K, 0.1%, ±25ppm, 1/2W, 2512	MC010837	Resistor, Thin Film, 1K, 0.1%, ±25ppm, 1/16W, 0603	MCTF0603 BTC1001
Resistor, Thin Film, 562K, 0.1%, ±25ppm, 1/2W, 2512	MC010838	Resistor, Thin Film, 1K, 0.1%, ±25ppm, 1/10W, 0805	MCTF0805 BTC1001
Resistor, Thin Film, 576K, 0.1%, ±25ppm, 1/2W, 2512	MC010839	Resistor, Thin Film, 1K5, 0.1%, ±25ppm, 1/10W, 0805	MCTF0805 BTC1501
Resistor, Thin Film, 590K, 0.1%, ±25ppm, 1/2W, 2512	MC010840	Resistor, Thin Film, 15K, 0.1%, ±25ppm, 1/10W, 0805	MCTF0805 BTC1502
Resistor, Thin Film, 604K, 0.1%, ±25ppm, 1/2W, 2512	MC010841	Resistor, Thin Film, 150K, 0.1%, ±25ppm, 1/10W, 0805	MCTF0805 BTC1503
Resistor, Thin Film, 619K, 0.1%, ±25ppm, 1/2W, 2512	MC010842	Resistor, Thin Film, 2K, 0.1%, ±25ppm, 1/10W, 0805	MCTF0805 BTC2001
Resistor, Thin Film, 634K, 0.1%, ±25ppm, 1/2W, 2512	MC010843	Resistor, Thin Film, 20K, 0.1%, ±25ppm, 1/10W, 0805	MCTF0805 BTC2002
Resistor, Thin Film, 649K, 0.1%, ±25ppm, 1/2W, 2512	MC010844	Resistor, Thin Film, 49K9, 0.1%, ±25ppm, 1/10W, 0805	MCTF0805 BTC4992
Resistor, Thin Film, 665K, 0.1%, ±25ppm, 1/2W, 2512	MC010845		
Resistor, Thin Film, 681K, 0.1%, ±25ppm, 1/2W, 2512	MC010846		
Resistor, Thin Film, 698K, 0.1%, ±25ppm, 1/2W, 2512	MC010847		
Resistor, Thin Film, 715K, 0.1%, ±25ppm, 1/2W, 2512	MC010848		
Resistor, Thin Film, 732K, 0.1%, ±25ppm, 1/2W, 2512	MC010849		

Important Notice : This data sheet and its contents (the "Information") belong to the members of the Premier Farnell group of companies (the "Group") or are licensed to it. No licence is granted for the use of it other than for information purposes in connection with the products to which it relates. No licence of any intellectual property rights is granted. The Information is subject to change without notice and replaces all data sheets previously supplied. The Information supplied is believed to be accurate but the Group assumes no responsibility for its accuracy or completeness, any error in or omission from it or for any use made of it. Users of this data sheet should check for themselves the Information and the suitability of the products for their purpose and not make any assumptions based on information included or omitted. Liability for loss or damage resulting from any reliance on the Information or use of it (including liability resulting from negligence or where the Group was aware of the possibility of such loss or damage arising) is excluded. This will not operate to limit or restrict the Group's liability for death or personal injury resulting from its negligence. Multicomp is the registered trademark of the Group. © Premier Farnell Limited 2016.