

RS Pro M12 Panel Mount Male 8W 100mm, PG9

RS Stock No: 144-7610

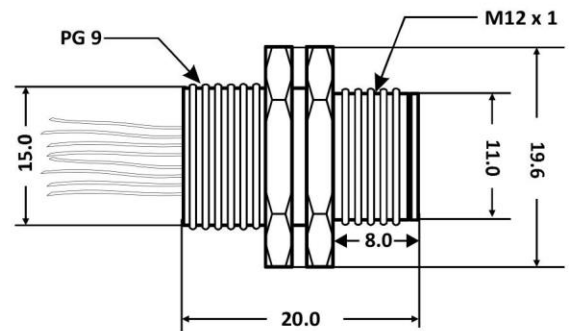

All dimensions are in mm.

General Specification

Rated Operational Voltage	30 V
Current Rating	2A
Insulation Resistance	>= 100 MΩ
Temperature Range	-25°C ... +75°C
Degree of Protection	IP67

Pin Assignment

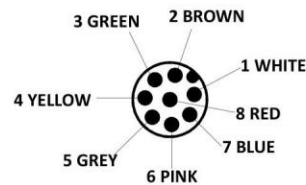

Material Specification

Housing Material	Brass Ni Plated
Contact	Cu-Zn
Contact Plating	Gold Plated
Contact Carrier	Nylon 66
O-Ring	Neoprene
Pole	8
Clamp Nut	PG9

Cable Specification

Cross Section of Wire	0.25 sq.mm
Termination	Partially Stripped
Cable length	100 mm