



ENGLISH

Datasheet

Cable Plug Bayonet Locking

RS Stock number 490-955



Specifications:

Rating:	100V AC 4A max.
Contact Resistance:	Pins-30mΩ max; shell-50mΩ max.
Insulation Resistance:	100MΩ min. at 500V DC
Voltage Withstand:	250V AC R.M.S for 1 minute

Dimensions(mm)

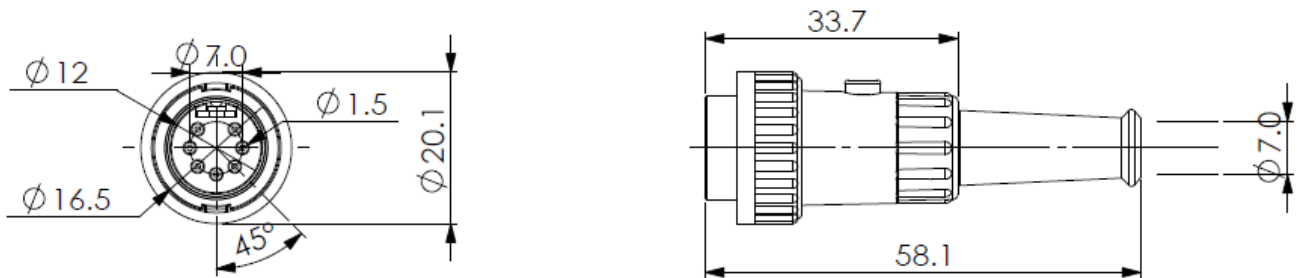

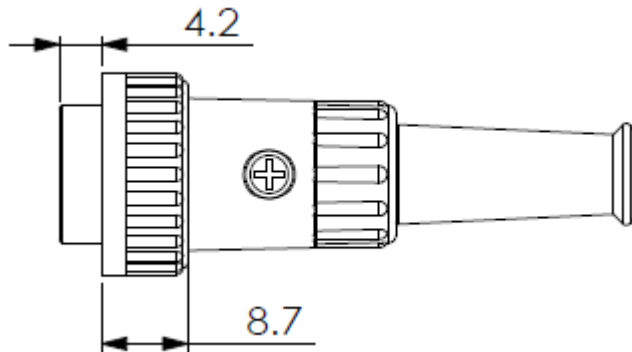

No.	Description	Material	Treat
1	Shield Cover	Zn Alloy	Nickel Ptd.
2	Screw Cap	Zn Alloy	Nickel Ptd.
3	'T' Holder	Steel	Nickel Ptd.
4	Setscrew	Steel	Nickel Ptd.
5	Housing	ABS	
6	Terminals	Brass	Silver Ptd.
7	Strain Boot	PVC	