



FEATURES

- Ultralow phase noise: -160 dBc/Hz typical at 10 kHz
- Output power for 1 dB compression (P1dB): 15 dBm typical at 2 GHz to 12 GHz frequency range
- Gain: 13.5 dB typical at 2 GHz to 12 GHz frequency range
- Output third-order intercept (IP3): 27 dBm typical at 2 GHz to 12 GHz frequency range
- Supply voltage: 5.0 V at 64 mA typical
- 50 Ω matched input/output
- 32-terminal, ceramic, leadless chip carrier (LCC)

APPLICATIONS

- Radars, electronic warfare (EW), and electronic counter measures (ECMs)
- Microwave radios
- Test instrumentation
- Military and space
- Fiber optic systems

GENERAL DESCRIPTION

The HMC606LC5 is a gallium arsenide (GaAs), indium gallium phosphide (InGaP), heterojunction bipolar transistor (HBT), monolithic microwave integrated circuit (MMIC) distributed amplifier housed in a 32-terminal, ceramic, leadless chip carrier (LCC) package that operates from 2 GHz to 18 GHz. With an input signal of 12 GHz, the amplifier provides ultralow phase noise performance of -160 dBc/Hz at a 10 kHz offset, representing a significant improvement over field effect transistor (FET)-based distributed amplifiers.

FUNCTIONAL BLOCK DIAGRAM

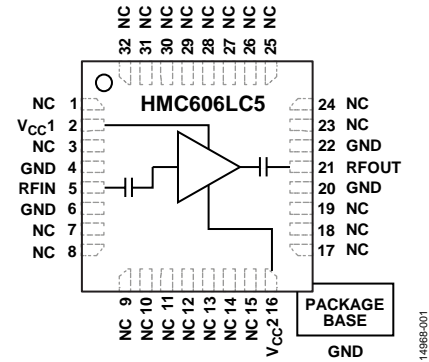

Figure 1.

The HMC606LC5 provides 13.5 dB of small signal gain, 27 dBm output IP3, and 15 dBm of output power for 1 dB compression while requiring 64 mA from a 5.0 V supply. The input and output of the HMC606LC5 amplifier are internally matched to 50 Ω and are internally dc blocked.

TABLE OF CONTENTS

Features	1	Pin Configuration and Function Descriptions	5
Applications	1	Interface Schematics	5
Functional Block Diagram	1	Typical Performance Characteristics	6
General Description	1	Applications Information	8
Revision History	2	Evaluation Printed Circuit Board (PCB)	8
Specifications	3	Outline Dimensions	9
Electrical Specifications	3	Ordering Guide	9
Absolute Maximum Ratings	4		
ESD Caution	4		

REVISION HISTORY

3/2020—Rev. I to Rev. J

Deleted Figure 16, Figure 17, and Figure 18; Renumbered Sequentially	8
--	---

1/2018—Rev. H to Rev. I

Changes to Figure 16, Figure 16 Caption, Figure 17, Figure 17 Caption, Figure 18, Figure 18 Caption, and Figure 19	8
Changes to Ordering Guide	10

10/2017—Rev. G to Rev. H

Changes to Typical Performance Characteristics Section	7
Added Figure 19; Renumbered Sequentially	9
Updated Outline Dimensions	10
Changes to Ordering Guide	10

8/2017—Rev. F to Rev. G

Changes to Continuous Power Dissipation, P_{DISS} Parameter, Table 4	4
This Hittite Microwave Products data sheet has been reformatted to meet the styles and standards of Analog Devices, Inc.	

2/2017—Rev. 05.0514 to Rev. F

Updated Format	Universal
Changes to Features Section and General Description Section	1
Changes to Table 4	4
Updated Outline Dimensions	9
Changes to Ordering Guide	9

SPECIFICATIONS

ELECTRICAL SPECIFICATIONS

$T_A = 25^\circ\text{C}$, $V_{CC1} = V_{CC2} = 5\text{ V}$, unless otherwise noted.

Table 1.

Parameter	Min	Typ	Max	Unit
FREQUENCY RANGE	2		12	GHz
GAIN	10.5	13.5		dB
Flatness		± 1.0		dB
Variation Over Temperature		0.021		dB/ $^\circ\text{C}$
NOISE FIGURE		5		dB
INPUT RETURN LOSS		20		dB
OUTPUT				
Return Loss		15		dB
Power for 1 dB Compression (P1dB)	12	15		dBm
Saturated Power (P_{SAT})		17		dBm
Third-Order Intercept (IP3)		27		dBm
PHASE NOISE				
At 100 Hz		-140		dBc/Hz
At 1 kHz		-150		dBc/Hz
At 10 kHz		-160		dBc/Hz
At 1 MHz		-170		dBc/Hz
SUPPLY CURRENT		64	95	mA

Table 2.

Parameter	Min	Typ	Max	Unit
FREQUENCY RANGE	2		18	GHz
GAIN	9.5	12.5		dB
Flatness		± 1.0		dB
Variation Over Temperature		0.024		dB/ $^\circ\text{C}$
NOISE FIGURE		7		dB
INPUT RETURN LOSS		18		dB
OUTPUT				
Return Loss		15		dB
Power for 1 dB Compression (P1dB)	10	13		dBm
Saturated Power (P_{SAT})		15		dBm
Third-Order Intercept (IP3)		22		dBm
PHASE NOISE				
At 100 Hz		-140		dBc/Hz
At 1 kHz		-150		dBc/Hz
At 10 kHz		-160		dBc/Hz
At 1 MHz		-170		dBc/Hz
SUPPLY CURRENT		64	95	mA

Table 3. V_{CC1} , V_{CC2} vs. Typical Supply Current

V_{CC1} , V_{CC2} (V)	$I_{CC1} + I_{CC2}$ (mA)
4.5	53
5.0	64
5.5	71

ABSOLUTE MAXIMUM RATINGS

Table 4.

Parameter	Rating
$V_{CC1} = V_{CC2}$	7 V
RF Input Power (RFIN)	15 dBm
Channel Temperature	175°C
Continuous Power Dissipation, P_{DISS} ($T_A = 85^\circ\text{C}$, Derate 10.9 mW/°C Above 85°C)	0.978 W
Maximum Peak Reflow Temperature (MSL3) ¹	260°C
Thermal Resistance (Channel to Ground Paddle)	92°C/W
Storage Temperature Range	-65°C to +150°C
Operating Temperature Range	-40°C to +85°C
ESD Sensitivity (Human Body Model, HBM)	Class 0, Pass 100 V

¹ See the Ordering Guide section.

Stresses at or above those listed under Absolute Maximum Ratings may cause permanent damage to the product. This is a stress rating only; functional operation of the product at these or any other conditions above those indicated in the operational section of this specification is not implied. Operation beyond the maximum operating conditions for extended periods may affect product reliability.

ESD CAUTION



ESD (electrostatic discharge) sensitive device. Charged devices and circuit boards can discharge without detection. Although this product features patented or proprietary protection circuitry, damage may occur on devices subjected to high energy ESD. Therefore, proper ESD precautions should be taken to avoid performance degradation or loss of functionality.

PIN CONFIGURATION AND FUNCTION DESCRIPTIONS

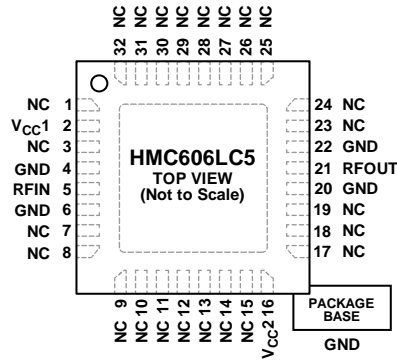

NOTES
 1. NC = NO CONNECT. THESE PINS MAY BE CONNECTED TO RF GROUND. PERFORMANCE WILL NOT BE AFFECTED.
 2. THE EXPOSED PAD MUST BE CONNECTED TO RF/DC GROUND.

Figure 2. Pin Configuration

Table 5. Pin Function Descriptions

Pin No.	Mnemonic	Description
1, 3, 7 to 15, 17 to 19, 23 to 32	NC	No Connect. These pins may be connected to RF ground. Performance will not be affected.
2, 16	V _{CC1} , V _{CC2}	Power Supply Voltages for the Amplifier. See Figure 3 for the interface schematic.
4, 6, 20, 22	GND	Ground. These pins must be connected to RF/dc ground. See Figure 4 for the interface schematic.
5	RFIN	RF Input. This pin is ac-coupled and matched to 50 Ω. See Figure 5 for the interface schematic.
21	RFOUT	RF Output. This pin is ac-coupled and matched to 50 Ω. See Figure 6 for the interface schematic.
	EPAD	Exposed Pad. The exposed pad must be connected to RF/dc ground.

INTERFACE SCHEMATICS

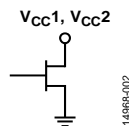

Figure 3. V_{CC1}, V_{CC2} Interface Schematic



Figure 4. GND Interface Schematic

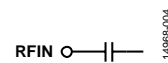

Figure 5. RFIN Interface Schematic

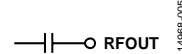

Figure 6. RFOUT Interface Schematic

TYPICAL PERFORMANCE CHARACTERISTICS

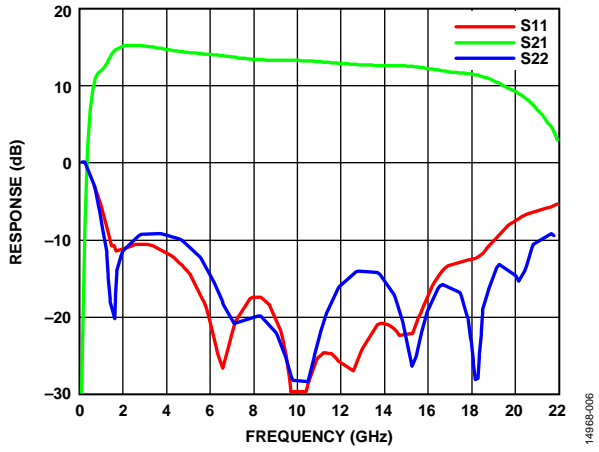

Figure 7. Response (Gain and Return Loss) vs. Frequency

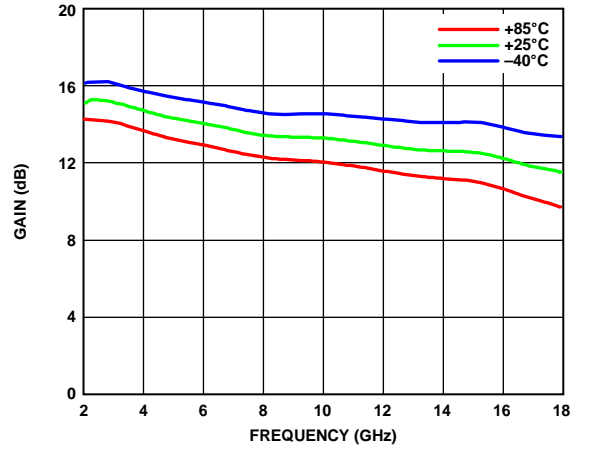

Figure 10. Gain vs. Frequency for Various Temperatures

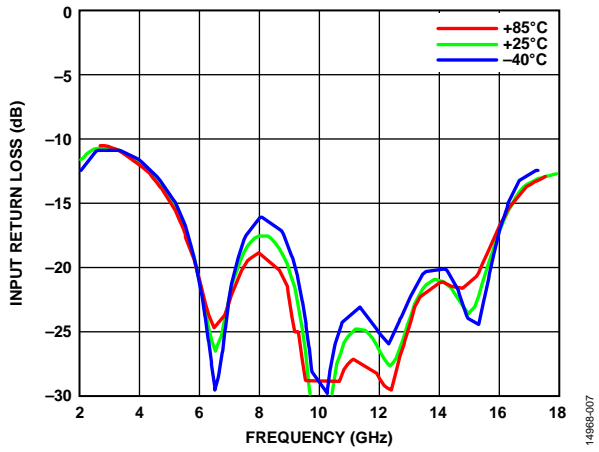

Figure 8. Input Return Loss vs. Frequency for Various Temperatures

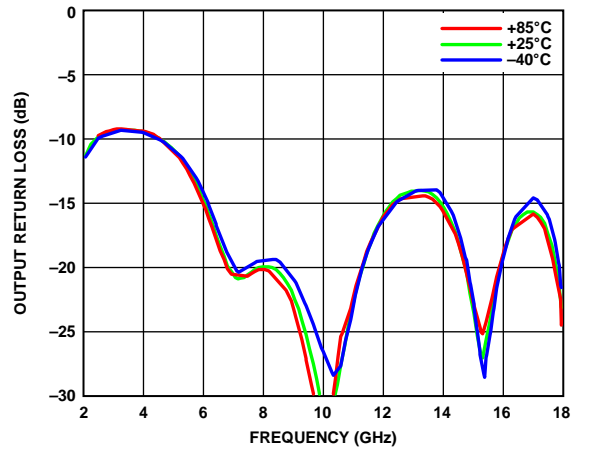

Figure 11. Output Return Loss vs. Frequency for Various Temperatures

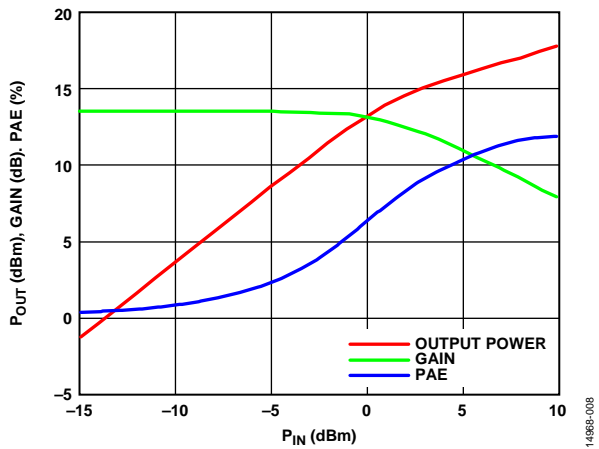

Figure 9. Output Power (P_{OUT}), Gain, and Power Added Efficiency (PAE) vs. Input Power (P_{IN})

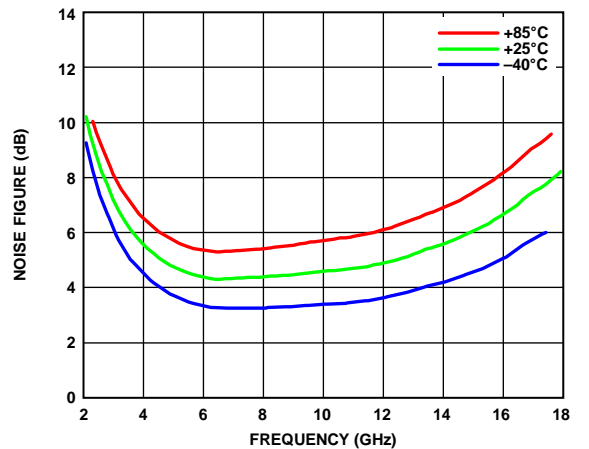

Figure 12. Noise Figure vs. Frequency for Various Temperatures

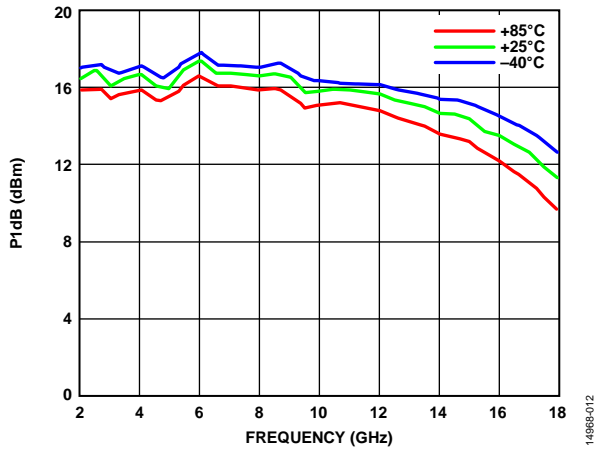

Figure 13. Power for 1 dB Compression (P_{1dB}) vs. Frequency for Various Temperatures

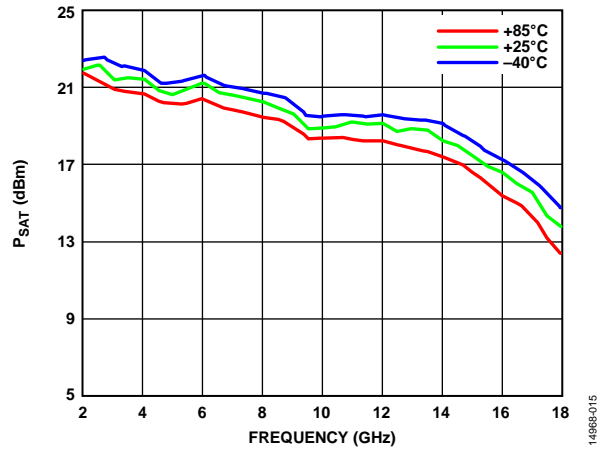

Figure 15. Saturated Power (P_{SAT}) vs. Frequency for Various Temperatures

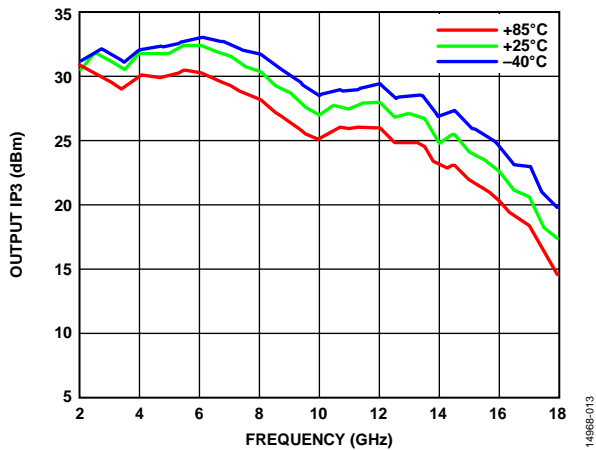

Figure 14. Output Third-Order Intercept (IP_3) vs. Frequency for Various Temperatures

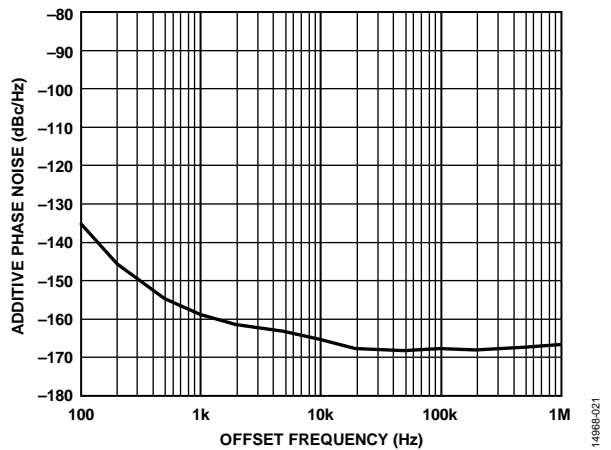

Figure 16. Additive Phase Noise vs. Offset Frequency, RF Frequency = 8 GHz, RF Input Power = 12 dBm (P_{SAT})

APPLICATIONS INFORMATION

EVALUATION PRINTED CIRCUIT BOARD (PCB)

The circuit board used in the application must use RF circuit design techniques. Signal lines must have 50 Ω impedance, and the package ground leads and package bottom must be connected directly to the ground plane similar to that shown in Figure 17.

Use a sufficient number of via holes to connect the top and bottom ground planes. Mount the evaluation PCB to an appropriate heat sink. The evaluation PCB shown in Figure 17 is available from Analog Devices, Inc., upon request.

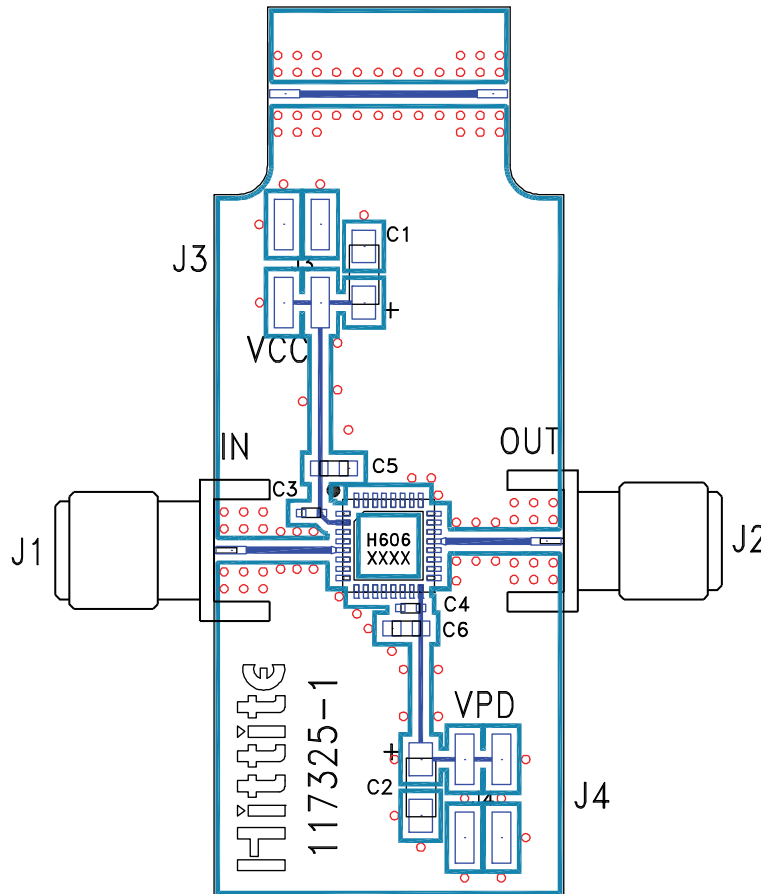

Figure 17. Evaluation PCB

Table 6. List of Materials for Evaluation PCB (117156-HMC606LC5¹)

Item	Description
J1, J2	SRI K connectors
J3, J4	2 mm Molex headers
C1, C2	4.7 μF, tantalum capacitors
C3, C4	100 pF capacitors, 0402 package
C5, C6	1000 pF capacitors, 0603 package
U1	HMC606LC5
PCB	117325-1 evaluation PCB; circuit board material: Rogers 4350

¹ Reference this number when ordering the complete evaluation PCB.

OUTLINE DIMENSIONS

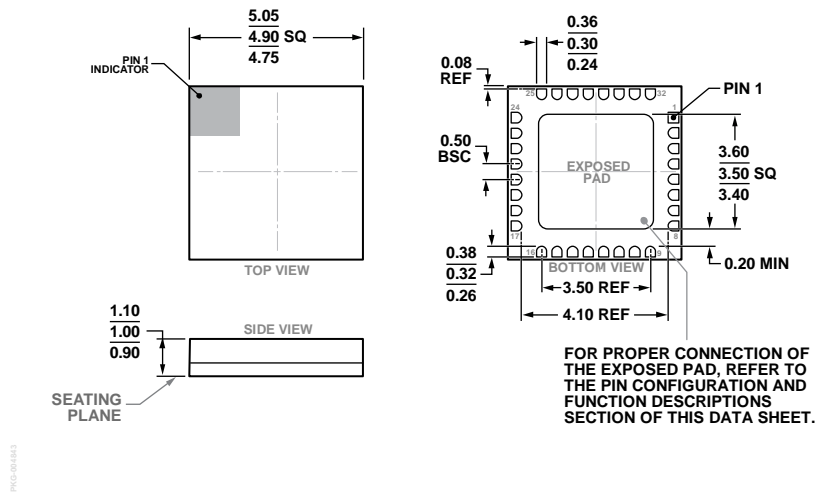

Figure 18. 32-Terminal Ceramic Leadless Chip Carrier [LCC] (E-32-1)
Dimensions shown in millimeters

ORDERING GUIDE

Model ¹	Temperature Range	MSL Rating ²	Package Description	Package Option
HMC606LC5	-40°C to +85°C	MSL3	32-Terminal Ceramic Leadless Chip Carrier [LCC]	E-32-1
HMC606LC5TR	-40°C to +85°C	MSL3	32-Terminal Ceramic Leadless Chip Carrier [LCC]	E-32-1
HMC606LC5TR-R5	-40°C to +85°C	MSL3	32-Terminal Ceramic Leadless Chip Carrier [LCC]	E-32-1
117156-HMC606LC5			Evaluation Board	

¹ All models are RoHS Compliant.

² See the Absolute Maximum Ratings section.