

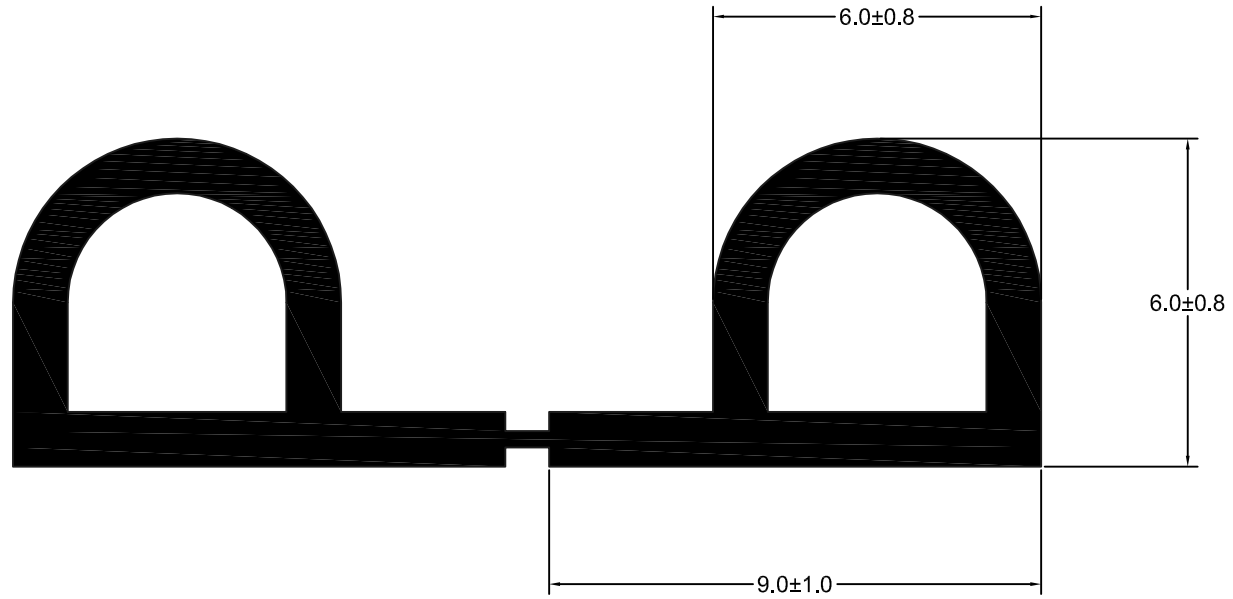

Rev No	Revision note	Date



A3 1:1

Description	Customer Ref	Area	Material
			EPDM
	Drawn	Checked by	Scale 10:1
	Tolerance	Product Ref:	Drawing Number Issue
	Date		HP0344 01