

Click [here](#) to ask an associate for production status of specific part numbers.

MAX98397

28V Digital Input, Class-DG Amplifier with IVSENSE, Ultra-Low I_Q, and Brownout Prevention

General Description

The MAX98397 is a high-efficiency, mono Class-DG speaker amplifier with industry-leading quiescent power, featuring integrated speaker current and voltage sensing (IVSENSE), a brownout-prevention engine (BPE), and dynamic-headroom tracking (DHT). The device also enables ultrasound applications by providing support for sample rates up to 192kHz, a higher passband (for $f_S > 50\text{kHz}$), and a bypass path for the ultrasound signals through the amplifier so it is not attenuated by the audio processing. Precision output current monitoring (ISENSE) and voltage monitoring (VSENSE) enable speaker protection algorithms to be run by a host device. Spread-spectrum modulation (SSM) and edge rate control minimize EMI and eliminate the need for the output filtering found in traditional Class-D devices.

To achieve industry-leading quiescent power, the Class-DG architecture employs two supply rails; VBAT (3V to 5.5V) and PVDD (3V to 28V) to supply the speaker amplifier. The Class-DG amplifier switches between the two supply rails depending on the input signal level and/or the supply headroom.

For battery-powered applications, the BPE is designed to help prevent the possibility of a system brownout by reducing the device's contribution to the overall system power consumption. This is achieved by either attenuating or limiting the amplifier output when the device supply drops below a set of programmable BPE thresholds. Additionally, as the power-supply voltage varies due to sudden transients and declining battery life, DHT automatically optimizes the headroom available to the Class-DG amplifier to maintain consistent distortion and listening levels.

The device provides a PCM interface for audio data and a standard I²C interface for control data communication. The PCM interface supports audio playback using I²S, left-justified, and time-division multiplexing audio data formats. A unique clocking structure eliminates the need for an external system clock (MCLK) for PCM communication, which reduces pin count and simplifies board layout.

Thermal foldback, when enabled, automatically reduces the output power when the temperature exceeds a user-specified threshold. This allows for uninterrupted music playback even at high ambient temperatures. Traditional thermal protection is also available in addition to robust overcurrent protection.

The device is available in a 0.4mm pitch, 35-bump wafer-level package (WLP). The device operates over the extended -40°C to +85°C temperature range.

Applications

- Mobile Speakers and Smart Speakers
- Tablets, Laptop and Desktop Computers
- Soundbars
- Smart IOT

Benefits and Features

- Wide Input Supply Range (3V to 28V)
- Class-DG Operation Enables Industry Leading Quiescent Power
 - 21mW at $V_{PVDD} = 20\text{V}$, $V_{VBAT} = 3.8\text{V}$
 - 25.3mW at $V_{PVDD} = 24\text{V}$, $V_{VBAT} = 5.0\text{V}$
- Ultra-Low Noise Floor
 - 21.5 μVRMS Output Noise
 - 117.8dB Dynamic Range
- Low Distortion
 - -85dB THD+N at 3W into 8 Ω , $f = 1\text{kHz}$
 - -85dB THD+N at 6W into 4 Ω , $f = 1\text{kHz}$
 - -80dB THD+N at 1W into 8 Ω , $f = 6\text{kHz}$, $F_{SW} = 650\text{kHz}$
- Output Power:
 - 42W into 8 Ω , $V_{PVDD} = 28\text{V}$, THD+N = 1%
 - 26W into 4 Ω , $V_{PVDD} = 16\text{V}$, THD+N = 1%
 - 51W into 8 Ω , $V_{PVDD} = 28\text{V}$, THD+N = 10%
- 100W Peak Output Power into 4 Ω , $V_{PVDD} = 28\text{V}$
- Speaker Amplifier Efficiency:
 - 83% at 1W into 8 Ω , $V_{PVDD} = 24\text{V}$
 - 93% Peak Efficiency into 8 Ω , $V_{PVDD} = 24\text{V}$
 - 81% at 1W into 4 Ω , $V_{PVDD} = 24\text{V}$
 - 90% Peak Efficiency into 4 Ω , $V_{PVDD} = 24\text{V}$
- Class-D EMI Reduction Enables Filterless Operation
- Spread-Spectrum Modulation and Switching-Edge Rate Control
- Integrated Speaker Current and Voltage Sense Do Not Require External Components
- Flexible Brownout-Prevention Engine
- I²S/16-Channel TDM and I²C Digital Interfaces
- Playback Support for 16-, 24-, and 32-Bit Data Words
- Playback and IV Paths Support Sample Rates up to 192kHz
- Audio Processing Bypass Path
- Dynamic Headroom Tracking (DHT) Maintains a Consistent Listening Experience
- Extensive Click-and-Pop Suppression
- 35-Bump WLP (0.4mm Pitch)

Ordering Information appears at end of data sheet.

SMBus is a trademark of Intel Corp.

19-101757; Rev 0; 10/23

Simplified Block Diagram

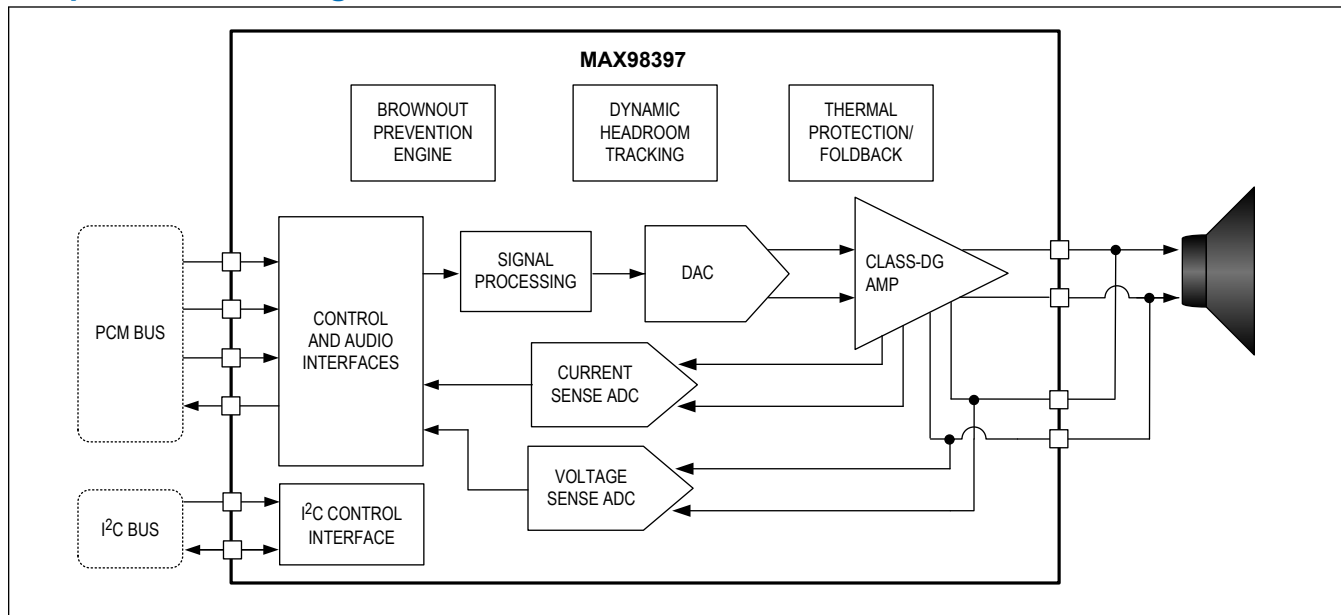

TABLE OF CONTENTS

General Description	1
Applications	1
Benefits and Features	1
Simplified Block Diagram	2
Absolute Maximum Ratings	8
Package Information	8
35 WLP	8
Electrical Characteristics	8
Typical Operating Characteristics	24
Pin Configuration	34
35 WLP	34
Pin Description	34
Detailed Description	36
Device State Control	36
Hardware-Shutdown State	36
Software-Shutdown State	36
Active State	37
Device Sequencing	37
Power-Supply Sequencing	38
PCM Interface	38
PCM Clock Configuration	38
PCM Data Format Configuration	38
I ² S/Left-Justified Mode	38
TDM Modes	40
PCM Data Path Configuration	42
PCM Data Input	43
PCM Data Output	43
Data Output Channel-Interleaved I/V Sense Data	44
Data Output Status Bits	45
Interrupts	46
Interrupt Bit Field Composition	46
Interrupt Output Configuration	46
Interrupt Sources	46
Speaker Path	48
Speaker Path Block Diagram	48
Speaker Playback Path	48
Speaker Path Noise Gate	48
Speaker Path Dither	49
Speaker Path Data Inversion	49

TABLE OF CONTENTS (CONTINUED)

Speaker Path DC Blocking Filter	49
Speaker Path Digital Volume Control	49
Speaker Path Digital Gain Control	49
Speaker Path DSP Data Feedback Path	49
Speaker-Safe Mode	49
Speaker Audio Processing Bypass Path	49
Bypass Path Data Inversion	49
Bypass Path Dither	50
Bypass Path DC Blocking Filter	50
Speaker Maximum Peak Output Voltage Scaling	50
Dynamic Headroom Tracking (DHT)	50
DHT Supply Tracking and Headroom	50
DHT Mode 1—Signal Distortion Limiter	53
DHT Mode 2—Signal Level Limiter	58
DHT Mode 3—Dynamic Range Compressor	60
DHT Mode 4—Dynamic Range Compressor with Signal Level Limiter	62
DHT Attenuation	64
DHT Attenuation Reporting	66
DHT Ballistics	66
Speaker Amplifier	67
Speaker Amplifier Operating Modes	67
Class-DG Mode Enabled	67
Delay for DG Mode	68
Class-DG Mode Disabled	68
IDLE Mode	68
Speaker Amplifier Ultra-Low EMI Filterless Operation	68
Speaker Amplifier Overcurrent Protection	69
Speaker Current and Voltage Sense ADC Path	69
Brownout-Prevention Engine	69
BPE State Controller and Level Thresholds	70
BPE Level Configuration Options	70
BPE Gain Attenuation Function	71
BPE Limiter Function	71
Brownout Interrupts	71
Measurement ADC	71
Measurement ADC Channel Optimal Mode	72
Measurement ADC Thermal Channel	72
Measurement ADC PVDD Channel	73
Measurement ADC VBAT Channel	73

TABLE OF CONTENTS (CONTINUED)

Measurement ADC VDDH Channel	74
Clock and Data Monitors	74
Input Data Monitor	74
Clock Monitor	75
Clock Activity and Frequency Detection	76
Clock Frame Error Detection	76
Speaker Monitor	77
Thermal Protection	77
Thermal Warning and Thermal Shutdown Configuration	77
Thermal Shutdown Recovery Configuration	77
Thermal Foldback	77
Tone Generator	78
Pink Noise Generator	78
Interchip Communication	78
ICC Operation and Data Format	79
Multiamplifier Grouping	79
ICC Over PCM Output (DOUT)	80
I ² C Serial Interface	81
Peripheral Address	81
Bit Transfer	82
START and STOP Conditions	82
Early STOP Conditions	82
Acknowledge	82
Write Data Format	83
Read Data Format	84
I ² C Register Map	85
Control Bit Field Types and Write Access Restrictions	85
Register Map	86
Register Map	86
Register Details	94
Applications Information	168
Layout and Grounding	168
Recommended External Components	168
Bootstrap Capacitors	168
Typical Application Circuits	169
Typical Application Circuit	169
Ordering Information	169
Revision History	170

LIST OF FIGURES

Figure 1. Standard I ² S Mode	39
Figure 2. Left-Justified Mode	39
Figure 3. Left-Justified Mode (LRCLK Inverted)	40
Figure 4. Left-Justified Mode (BCLK Inverted)	40
Figure 5. TDM Modes	42
Figure 6. PCM Data Input	43
Figure 7. I ² S Mode with Interleaved Voltage and Current Data, Channel Length = 24 Bits, Zero Padding	45
Figure 8. Speaker Signal Path Diagram	48
Figure 9. Simplified Dynamic Headroom Tracking System Block Diagram	50
Figure 10. V_{TPO} and A_{TPO} Calculation Example	52
Figure 11. Signal Distortion Limiter with $V_{MPO} \leq V_{SUP}$ and +20% Headroom (SUP_{HR})	54
Figure 12. Signal Distortion Limiter with $V_{MPO} \leq V_{SUP}$ and 0% Headroom (SUP_{HR})	55
Figure 13. Signal Distortion Limiter with $V_{MPO} \leq V_{SUP}$ and -20% Headroom (SUP_{HR})	56
Figure 14. Signal Distortion Limiter with $V_{MPO} > V_{SUP}$ and +20% Headroom (SUP_{HR})	57
Figure 15. Signal Distortion Limiter with $V_{MPO} > V_{SUP}$ and 0% Headroom (SUP_{HR})	57
Figure 16. Signal Distortion Limiter with $V_{MPO} > V_{SUP}$ and -20% Headroom (SUP_{HR})	58
Figure 17. Signal Level Limiter with $V_{TPO} > V_{SLL}$ as V_{SUP} Decreases	59
Figure 18. Signal Level Limiter with $V_{TPO} < V_{SLL}$ Showing Amplifier Output Clipping	60
Figure 19. Dynamic Range Compression with Decreasing V_{SUP} and $SUP_{HR} \geq 0\%$	61
Figure 20. Dynamic Range Compressor with $SUP_{HR} < 0\%$ and Output Clipping	62
Figure 21. DHT DRC and SLL with Decreasing $V_{SUP}(V_{TPO})$, and $SUP_{HR} \geq 0\%$	63
Figure 22. DHT DRC and SLL with Decreasing $V_{SUP}(V_{TPO})$, and $SUP_{HR} < 0\%$	64
Figure 23. Distortion Limiter Case with -20% Headroom and A_{MAX} Exceeded	65
Figure 24. Distortion Limiter Case with +20% Headroom and A_{MAX} Exceeded	66
Figure 25. BPE Block Diagram	70
Figure 26. Data Monitor Error Generation due to Input Data Stuck Error Detection	75
Figure 27. Monitor Error Generation due to Input Data Magnitude Error Detection	75
Figure 28. Clock Monitor LRCLK Rate Error Example with $CMON_ERRTOL = 0x1$	76
Figure 29. Clock Monitor Framing Error Example in TDM Mode with $PCM_BSEL = 0x6$ and $CMON_BSELTOL = 0x0$	77
Figure 30. ICC Multigroup Example with Two Groups and Four Total Devices	80
Figure 31. I ² C Interface Timing Diagram	81
Figure 32. I ² C START, STOP, and REPEATED START Conditions	82
Figure 33. I ² C Acknowledge	83
Figure 34. I ² C Writing One Byte of Data to the Peripheral	83
Figure 35. I ² C Writing n-Bytes of Data to the Peripheral	84
Figure 36. I ² C Controller Reading One Byte of Data from the Peripheral	84
Figure 37. I ² C Controller Reading n-Bytes of Data from the Peripheral	84

LIST OF TABLES

Table 1. Typical Power-Up Sequence	37
Table 2. Typical Power-Down Sequence	37
Table 3. Sample Rate Selection For I/V Sense	38
Table 4. Supported I ² S/Left-Justified Mode Configurations	39
Table 5. Supported TDM Mode Configurations	40
Table 6. Supported PCM Data Output Types	44
Table 7. Interrupt Sources	46
Table 8. Noise Gate Threshold LSB Location by Input Data Configuration	49
Table 9. Brownout-Prevention Engine Levels	70
Table 10. Measurement ADC Channels Sample Rate in Optimal Modes	72
Table 11. I ² C Peripheral Address	81
Table 12. Control Bit Types and Write Access Restrictions	85
Table 13. Component List	168

Absolute Maximum Ratings

VBAT to PGND	-0.3V to +6.0V	All Other Digital Pins to DGND	-0.3V to $V_{DVDD} + 0.3V$
PVDD, VDDH_SNS to PGND	-0.3V to +33V	Short-Circuit Duration Between OUTP, OUTN, and PGND or PVDD or VBAT	Continuous
PVDD to VBAT	-0.3V to $33 - V_{VBAT}$	Short-Circuit Duration Between OUTP and OUTN	Continuous
AGND, DGND to PGND	-0.1V to +0.1V	Continuous Power Dissipation for Multilayer Board ($T_A = +70^\circ C$, derate 21.59mW/ $^\circ C$ above $+70^\circ C$)	1726mW
AVDD to AGND	-0.3V to +2.2V	Junction Temperature	+150 $^\circ C$
DVDD to DGND	-0.3V to +2.2V	Operating Temperature Range	-40 $^\circ C$ to +85 $^\circ C$
OUTP, OUTN to PGND	-0.3V to $V_{PVDD} + 0.3V$	Storage Temperature Range	-65 $^\circ C$ to +150 $^\circ C$
OUTPSNS, OUTNSNS to PGND	-0.3V to +33 V	Soldering Temperature (reflow)	+260 $^\circ C$
VBOOTP to OUTP, VBOOTN to OUTN	-0.3V to 2.2V		
SDA, SCL, ADDR1, ADDR2 to DGND	-0.3V to +6.0V		

Stresses beyond those listed under "Absolute Maximum Ratings" may cause permanent damage to the device. These are stress ratings only, and functional operation of the device at these or any other conditions beyond those indicated in the operational sections of the specifications is not implied. Exposure to absolute maximum rating conditions for extended periods may affect device reliability.

Package Information

35 WLP

Package Code	W352B2Z+1
Outline Number	21-100607
Land Pattern Number	Refer to Application Note 1891
Thermal Resistance, Six-Layer EV Kit Board:	
Junction-to-Ambient (θ_{JA})	28 $^\circ C/W$
Junction-to-Case Thermal Resistance (θ_{JC})	3 $^\circ C/W$
Thermal Resistance, Four-Layer JEDEC Board:	
Junction-to-Ambient (θ_{JA})	46.33 $^\circ C/W$
Junction-to-Case Thermal Resistance (θ_{JC})	3 $^\circ C/W$

For the latest package outline information and land patterns (footprints), go to <https://www.analog.com/en/design-center/packaging-quality-symbols-footprints/package-index>. Note that a "+", "#", or "-" in the package code indicates RoHS status only. Package drawings may show a different suffix character, but the drawing pertains to the package regardless of RoHS status.

Package thermal resistances were obtained using the method described in JEDEC specification JESD51-7, using a four-layer board. For detailed information on package thermal considerations, refer to <https://www.analog.com/en/technical-articles/thermal-characterization-of-ic-packages>.

Electrical Characteristics

($V_{VBAT} = 5.0V$, $V_{PVDD} = 24V$, $V_{AVDD} = 1.8V$, $V_{DVDD} = 1.8V$, $C_{VBAT} = 1 \times 10\mu F$, $1 \times 0.1\mu F$, $C_{PVDD} = 1 \times 220\mu F$, $2 \times 10\mu F$, $2 \times 0.1\mu F$, $C_{AVDD} = 1\mu F$, $C_{DVDD} = 1\mu F$, $C_{VBOOTP} = 0.1\mu F$, $C_{VBOOTN} = 0.1\mu F$, $Z_{SPK} = \text{Open}$, $f_s = 48\text{kHz}$, AC Measurement Bandwidth = 20Hz to 20kHz, $SPK_GAIN_MAX = 0 \times 12$ (24dB), Data Width = 24-bit, $SPK_MODE = 0 \times 0$ (DG), $T_A = T_{MIN}$ to T_{MAX} unless otherwise noted. Typical values are at $T_A = +25^\circ C$ ([Note 2](#)))

PARAMETER	SYMBOL	CONDITIONS	MIN	TYP	MAX	UNITS
POWER SUPPLIES						
VBAT Power-Supply Operating Voltage Range	V_{VBAT}		3.0		5.5	V
VBAT Voltage	V_{VBAT}	Device is functional but parametric performance is not guaranteed	2.5			V

Electrical Characteristics (continued)

(V_{VBAT} = 5.0V, V_{PVDD} = 24V, V_{AVDD} = 1.8V, V_{DVDD} = 1.8V, C_{VBAT} = 1x10μF, 1x0.1μF, C_{PVDD} = 1x220μF, 2x10μF, 2x0.1μF, C_{AVDD} = 1μF, C_{DVDD} = 1μF, C_{VBOOTP} = 0.1μF, C_{VBOOTN} = 0.1μF, Z_{SPK} = Open, f_s = 48kHz, AC Measurement Bandwidth = 20Hz to 20kHz, SPK_GAIN_MAX = 0x12 (24dB), Data Width = 24-bit, SPK_MODE = 0x0 (DG), T_A = T_{MIN} to T_{MAX} unless otherwise noted. Typical values are at T_A = +25°C (Note 2))

PARAMETER	SYMBOL	CONDITIONS	MIN	TYP	MAX	UNITS
PVDD Power-Supply Operating Voltage Range	V _{PVDD}		3.0		28	V
PVDD Voltage	V _{PVDD}	Device is functional but parametric performance is not guaranteed	2.8			V
AVDD Power-Supply Voltage Range	V _{AVDD}		1.71	1.8	1.89	V
DVDD Power-Supply Voltage Range	V _{DVDD}		1.71	1.8	1.89	V
VBAT Undervoltage Lockout	V _{VBAT_UVLO}	V _{VBAT} falling	2.26		2.36	V
PVDD Undervoltage Lockout	V _{PVDD_UVLO}	V _{PVDD} falling	2.54		2.64	V
AVDD Undervoltage Lockout	V _{AVDD_UVLO}	V _{AVDD} falling	1.61		1.67	V
AVDD POK Threshold	V _{AVDD_POK}	V _{AVDD} falling	1.28		1.65	V
DVDD Undervoltage Lockout	V _{DVDD_UVLO}	V _{DVDD} falling	1.61		1.67	V
DVDD POK Threshold	V _{DVDD_POK}	V _{DVDD} falling	1.28		1.66	V
VBAT UVLO Hysteresis		(Note 3)	90	110		mV
PVDD UVLO Hysteresis		(Note 3)	90	110		mV
Supply Ramp Rate PVDD			0.1		100	V/ms
POWER CONSUMPTION						
POWER CONSUMPTION / QUIESCENT POWER CONSUMPTION						
Total Power Consumption	P _Q	All supplies, IV sense enabled	V _{PVDD} = 20V, V _{VBAT} = 3.8V, DG mode	21		mW
			V _{PVDD} = 16V, V _{VBAT} = 3.8V, DG mode	20.1	23	
			V _{PVDD} = 24V, V _{VBAT} = 5.0V, DG mode	25.3	28.5	
		All supplies, IV sense disabled	V _{PVDD} = 20V, V _{VBAT} = 3.8V, DG mode	15.5		
			V _{PVDD} = 16V, V _{VBAT} = 3.8V, DG mode	15.5		
			V _{PVDD} = 24V, V _{VBAT} = 5.0V, DG mode	19.8		

Electrical Characteristics (continued)

(V_{VBAT} = 5.0V, V_{PVDD} = 24V, V_{AVDD} = 1.8V, V_{DVDD} = 1.8V, C_{VBAT} = 1x10μF, 1x0.1μF, C_{PVDD} = 1x220μF, 2x10μF, 2x0.1μF, C_{AVDD} = 1μF, C_{DVDD} = 1μF, C_{VBOOTP} = 0.1μF, C_{VBOOTN} = 0.1μF, Z_{SPK} = Open, f_s = 48kHz, AC Measurement Bandwidth = 20Hz to 20kHz, SPK_GAIN_MAX = 0x12 (24dB), Data Width = 24-bit, SPK_MODE = 0x0 (DG), T_A = T_{MIN} to T_{MAX} unless otherwise noted. Typical values are at T_A = +25°C ([Note 2](#)))

PARAMETER	SYMBOL	CONDITIONS	MIN	TYP	MAX	UNITS	
Total Power Consumption	P _Q	All supplies, IV sense disabled	V _{PVDD} = 24V, V _{VBAT} = 3.8V, DG mode, noise gate enabled		4.2	mW	
			V _{PVDD} = 16V, V _{VBAT} = 3.8V, DG mode, noise gate enabled		4.1		
			V _{PVDD} = 27V, V _{VBAT} = 5.0V, DG mode, noise gate enabled		4.3		
PVDD Quiescent Current	I _{Q_PVDD}	IV sense enabled, V _{PVDD} = 24V, V _{VBAT} = 5V, DG mode		0.12	0.17	mA	
AVDD Quiescent Current	I _{AVDD}	IV sense enabled, V _{PVDD} = 24V, V _{VBAT} = 5V, DG mode		2.4	3	mA	
DVDD Quiescent Current	I _{DVDD}	IV sense enabled, V _{PVDD} = 24V, V _{VBAT} = 5V, DG mode		3.6	4	mA	
VBAT Quiescent Current	I _{VBAT}	IV sense enabled, V _{PVDD} = 24V, V _{VBAT} = 5V, DG mode		2.33	2.6	mA	
POWER CONSUMPTION / SOFTWARE SHUTDOWN							
VBAT Software Shutdown Supply Current	I _{SHDN_SW_VBAT}	AT	VBAT = 3.8V, No BCLK/LRCLK/DIN transactions, T _A = +25°C		0.2	1.2	μA
			VBAT = 3.8V, No BCLK/LRCLK/DIN transactions, T _A = +85°C (Note 3)			1.5	
			VBAT = 5.0V, No BCLK/LRCLK/DIN transactions, T _A = +25°C		0.5	2.6	
			VBAT = 5.0V, No BCLK/LRCLK/DIN transactions, T _A = +85°C (Note 3)			3.0	
PVDD Software Shutdown Supply Current	I _{SHDN_SW_PVDD}	DD	PVDD = 5.0V, No BCLK/LRCLK/DIN transactions, T _A = +25°C		0.2	1.5	μA
			PVDD = 5.0V, No BCLK/LRCLK/DIN transactions, T _A = +85°C (Note 3)			2	
			PVDD = 16V, No BCLK/LRCLK/DIN transactions, T _A = +25°C		0.8	4.2	
			PVDD = 16V, No BCLK/LRCLK/DIN transactions, T _A = +85°C (Note 3)			5.1	
			PVDD = 28V, No BCLK/LRCLK/DIN transactions, T _A = +25°C		2	10	
			PVDD = 28V, No BCLK/LRCLK/DIN transactions, T _A = +85°C (Note 3)			10	

Electrical Characteristics (continued)

(V_{VBAT} = 5.0V, V_{PVDD} = 24V, V_{AVDD} = 1.8V, V_{DVDD} = 1.8V, C_{VBAT} = 1x10μF, 1x0.1μF, C_{PVDD} = 1x220μF, 2x10μF, 2x0.1μF, C_{AVDD} = 1μF, C_{DVDD} = 1μF, C_{VBOOTP} = 0.1μF, C_{VBOOTN} = 0.1μF, Z_{SPK} = Open, f_s = 48kHz, AC Measurement Bandwidth = 20Hz to 20kHz, SPK_GAIN_MAX = 0x12 (24dB), Data Width = 24-bit, SPK_MODE = 0x0 (DG), T_A = T_{MIN} to T_{MAX} unless otherwise noted. Typical values are at T_A = +25°C ([Note 2](#)))

PARAMETER	SYMBOL	CONDITIONS	MIN	TYP	MAX	UNITS
AVDD Software Shutdown Supply Current	I _{SHDN_SW_AV} DD	No BCLK/LRCLK/DIN transactions, T _A = +25°C		1.5	5	μA
		No BCLK/LRCLK/DIN transactions, T _A = +85°C (Note 3)			10	
DVDD Software Shutdown Supply Current	I _{SHDN_SW_DV} DD	No BCLK/LRCLK/DIN transactions, T _A = +25°C		2.4	7.6	μA
		No BCLK/LRCLK/DIN transactions, T _A = +85°C (Note 3)			38	
POWER CONSUMPTION / HARDWARE SHUTDOWN						
VBAT Hardware Shutdown Supply Current	I _{SHDN_HW_VB} AT	VBAT = 3.8V, T _A = +25°C		0.1	1	μA
		VBAT = 3.8V, T _A = +85°C (Note 3)			1	
		VBAT = 5.0V, T _A = +25°C		0.2	1.5	
		VBAT = 5.0V, T _A = +85°C (Note 3)			2	
PVDD Hardware Shutdown Supply Current	I _{SHDN_HW_PV} DD	PVDD = 5.0V, T _A = +25°C		0.15	1.3	μA
		PVDD = 5.0V, T _A = +85°C (Note 3)			1.6	
		PVDD = 16V, T _A = +25°C		0.7	4.2	
		PVDD = 16V, T _A = +85°C (Note 3)			5	
		PVDD = 28V, T _A = +25°C		1.2	7.7	
		PVDD = 28V, T _A = +85°C (Note 3)			10	
AVDD Hardware Shutdown Supply Current	I _{SHDN_HW_AV} DD	T _A = +25°C		0.6	2.5	μA
		T _A = +85°C (Note 3)			5.5	
DVDD Hardware Shutdown Supply Current	I _{SHDN_HW_DV} DD	T _A = +25°C		1.45	5	μA
		T _A = +85°C (Note 3)			35	
Input Leakage Current	I _{VDDHSNS_LK} G	V _{VDDH_SNS} = 0V		0.01	1	μA
		V _{VDDH_SNS} = 28V		0.5	1	
TURN-ON/OFF TIME						
Turn-On Time	t _{ON}	From EN bit set to 1 to full operation, volume ramp disabled (Note 4)		1.5	3.0	ms
		From EN bit set to 1 to full operation, volume ramp enabled (Note 4)		3.0	6.0	ms
		Playback path re-enable: From SPK_EN bit set to 1 to full operation, EN = 1, volume ramp disabled		1		ms
Turn-Off Time	t _{OFF}	From full operation, EN bit set to 0 to software shutdown, volume ramp disabled		10	100	μs
		From full operation, EN bit set to 0 to software shutdown, volume ramp enabled		2.3	5	ms
		From SPK_EN bit set to 0 to amplifier disabled, volume ramp disabled, EN = 1		10		μs

Electrical Characteristics (continued)

(V_{BAT} = 5.0V, V_{PVDD} = 24V, V_{AVDD} = 1.8V, V_{DVDD} = 1.8V, C_{BAT} = 1x10μF, 1x0.1μF, C_{PVDD} = 1x220μF, 2x10μF, 2x0.1μF, C_{AVDD} = 1μF, C_{DVDD} = 1μF, C_{BOOTP} = 0.1μF, C_{BOOTN} = 0.1μF, Z_{SPK} = Open, f_s = 48kHz, AC Measurement Bandwidth = 20Hz to 20kHz, SPK_GAIN_MAX = 0x12 (24dB), Data Width = 24-bit, SPK_MODE = 0x0 (DG), T_A = T_{MIN} to T_{MAX} unless otherwise noted. Typical values are at T_A = +25°C (Note 2))

PARAMETER	SYMBOL	CONDITIONS	MIN	TYP	MAX	UNITS
DIGITAL AUDIO PATH						
DIGITAL AUDIO PATH / GAIN CONTROLS / DIGITAL VOLUME CONTROL						
Digital Volume Control (Max)	A _{SPK_VOL}	SPK_VOL[6:0] = 0x00		0		dB
Digital Volume Control Step Size				0.5		dB
Digital Volume Control (Min)	A _{SPK_VOL}	SPK_VOL[6:0] = 0xB4		-90		dB
DIGITAL AUDIO PATH / FILTERING / DIGITAL HIGHPASS FILTER CHARACTERISTICS (Note 5)						
DC Attenuation			80			dB
DC Blocking Cut Off Frequency		All sample rates		1.872		Hz
DIGITAL AUDIO PATH / FILTERING / DIGITAL FILTER CHARACTERISTICS (LRCLK < 50kHz) (Note 5)						
Valid Sample Rates			16		48	kHz
Passband Cutoff	f _{PLP}	Ripple < δ _p	0.452 x f _s			Hz
		Droop < -3dB	0.457 x f _s			Hz
Passband Ripple	δ _p	f < f _{PLP} , referenced to signal level at 1kHz	-0.35		+0.35	dB
Stopband Cutoff	f _{SLP}	Attenuation > δ _s			0.49 x f _s	Hz
Stopband Attenuation	δ _s	f > f _{SLP}	75			dB
Max Group Delay		f = 1kHz		5.5		Samples
DIGITAL AUDIO PATH / FILTERING / DIGITAL FILTER CHARACTERISTICS (LRCLK > 50kHz) (Note 5)						
Valid Sample Rates			88.2		192	kHz
Passband Cutoff	f _{PLP}	SPK_WBAND_FILTER_EN = 0	Ripple < δ _p , 88.2kHz ≤ f _s ≤ 96kHz	0.227 x f _s		Hz
			Droop < -3dB, 88.2kHz ≤ f _s ≤ 96kHz	0.314 x f _s		Hz
			Ripple < δ _p , 176.4kHz ≤ f _s ≤ 192kHz	0.1135 x f _s		Hz
			Droop < -3dB cutoff, 176.4kHz ≤ f _s ≤ 192kHz	0.232 x f _s		Hz
Passband Ripple	δ _p	SPK_WBAND_FILTER_EN = 0, f < f _{PLP} , referenced to signal level at 1kHz	-0.35		+0.35	dB
Stopband Cutoff	f _{SLP}	SPK_WBAND_FILTER_EN = 0, attenuation < δ _s			0.495 x f _s	Hz
Stopband Attenuation	δ _s	SPK_WBAND_FILTER_EN = 0, f > f _{SLP}	80			dB

Electrical Characteristics (continued)

(V_{VBAT} = 5.0V, V_{PVDD} = 24V, V_{AVDD} = 1.8V, V_{DVDD} = 1.8V, C_{VBAT} = 1x10μF, 1x0.1μF, C_{PVDD} = 1x220μF, 2x10μF, 2x0.1μF, C_{AVDD} = 1μF, C_{DVDD} = 1μF, C_{VBOOTP} = 0.1μF, C_{VBOOTN} = 0.1μF, Z_{SPK} = Open, f_S = 48kHz, AC Measurement Bandwidth = 20Hz to 20kHz, SPK_GAIN_MAX = 0x12 (24dB), Data Width = 24-bit, SPK_MODE = 0x0 (DG), T_A = T_{MIN} to T_{MAX} unless otherwise noted. Typical values are at T_A = +25°C (Note 2))

PARAMETER	SYMBOL	CONDITIONS	MIN	TYP	MAX	UNITS
Max Group Delay		SPK_WBAND_FILTER_EN = 0, f = 1kHz		6		Samples
DIGITAL AUDIO PATH / FILTERING / DIGITAL FILTER CHARACTERISTICS (LRCLK > 50kHz) (Note 5)						
Valid Sample Rates			88.2		192	kHz
Passband Cutoff	f _{PLP}	SPK_WBAND_FILTER_EN = 1	Ripple < δ _p , 88.2kHz ≤ f _S ≤ 96kHz	0.440 x f _S		Hz
			Droop < -3dB, 88.2kHz ≤ f _S ≤ 96kHz	0.45 x f _S		Hz
	f _{PLP}		Ripple < δ _p , 176.4kHz ≤ f _S ≤ 192kHz	0.23 x f _S		Hz
			Droop < -3dB cutoff, 176.4kHz ≤ f _S ≤ 192kHz	0.3 x f _S		Hz
Passband Ripple	δ _p	SPK_WBAND_FILTER_EN = 1, f < f _{PLP} , referenced to signal level at 1kHz	-0.5		+0.5	dB
Stopband Cutoff	f _{SLP}	SPK_WBAND_FILTER_EN = 1, attenuation < δ _S			0.52 x f _S	Hz
Stopband Attenuation	δ _S	SPK_WBAND_FILTER_EN = 1, f > f _{SLP}	-77			dB
Max Group Delay		SPK_WBAND_FILTER_EN = 1, f = 1kHz		5.5		Samples
Max Device-to-Device Group Delay Variability		f _{IN} = 1kHz		1		μs
CLASS-DG AMPLIFIER						
Output Offset Voltage	V _{OS}	T _A = +25°C, Z _{SPK} = 8Ω + 33μH, DRE_EN = 0	-3.5	±0.5	+3.5	mV
		T _A = +25°C, PVDD mode, Z _{SPK} = 8Ω + 33μH, DRE_EN = 0	-6	±0.5	+6	
Click-and-Pop Level	K _{CP}	Peak voltage, A-weighted, 32 samples per second, digital silence used for input signal, Z _{SPK} = 8Ω + 33μH or 4Ω + 33μH, into shutdown (Note 6)		-79		dBV
		Peak voltage, A-weighted, 32 samples per second, digital silence used for input signal, Z _{SPK} = 8Ω + 33μH or 4Ω + 33μH, out of shutdown (Note 6)		-69		
Efficiency	η _{SPK}	V _{PVDD} = 24V, V _{VBAT} = 5.0V, P _{OUT} = 1W, Z _L = 8Ω + 33μH, f _{IN} = 1kHz		83		%
	η _{SPK}	V _{PVDD} = 24V, V _{VBAT} = 5.0V, P _{OUT} = 5W, Z _L = 8Ω + 33μH, f _{IN} = 1kHz		90.5		
		V _{PVDD} = 24V, V _{VBAT} = 5.0V, P _{OUT} = 1W, Z _L = 4Ω + 33μH, f _{IN} = 1kHz		81		

Electrical Characteristics (continued)

(V_{VBAT} = 5.0V, V_{PVDD} = 24V, V_{AVDD} = 1.8V, V_{DVDD} = 1.8V, C_{VBAT} = 1x10μF, 1x0.1μF, C_{PVDD} = 1x220μF, 2x10μF, 2x0.1μF, C_{AVDD} = 1μF, C_{DVDD} = 1μF, C_{VBOOTP} = 0.1μF, C_{VBOOTN} = 0.1μF, Z_{SPK} = Open, f_s = 48kHz, AC Measurement Bandwidth = 20Hz to 20kHz, SPK_GAIN_MAX = 0x12 (24dB), Data Width = 24-bit, SPK_MODE = 0x0 (DG), T_A = T_{MIN} to T_{MAX} unless otherwise noted. Typical values are at T_A = +25°C (Note 2))

PARAMETER	SYMBOL	CONDITIONS	MIN	TYP	MAX	UNITS	
Output Power	P _{OUT}	V _{PVDD} = 24V, Z _L = 8Ω + 33μH, THD+N ≤ 1%, f _{IN} = 1kHz		33		W	
		V _{PVDD} = 24V, Z _L = 8Ω + 33μH, THD+N ≤ 10%, f _{IN} = 1kHz		40.5			
		V _{PVDD} = 16V, Z _L = 4Ω + 33μH, THD+N ≤ 1%, f _{IN} = 1kHz		26			
		V _{PVDD} = 16V, Z _L = 4Ω + 33μH, THD+N ≤ 10%, f _{IN} = 1kHz		32			
		V _{PVDD} = 28V, Z _L = 8Ω + 33μH, THD+N ≤ 1%, f _{IN} = 1kHz		42			
		V _{PVDD} = 28V, Z _L = 8Ω + 33μH, THD+N ≤ 10%, f _{IN} = 1kHz		51			
Peak Output Power	P _{OUT_PK}	Z _L = 4Ω + 33μH; P _{VDD} = 28V; 50Hz (2 period, peak signal)/1kHz (460 periods, low-amplitude signal) alternating signal; crest factor = 12dB; test duration = 1min with T _J < +100°C and THD+N < 1%		100		W	
Total Harmonic Distortion + Noise	THD+N	f _{IN} = 1kHz, P _{OUT} = 3W, Z _L = 8Ω + 33μH (Note 3)	-75	-85		dB	
		f _{IN} = 1kHz, P _{OUT} = 6W, Z _L = 4Ω + 33μH		-85			
		TRI_FSW2X_MODE = 1	f _{IN} = 6kHz, P _{OUT} = 1W, Z _L = 8Ω + 33μH		-82		
			f _{IN} = 6kHz, P _{OUT} = 2W, Z _L = 4Ω + 33μH		-80		
Intermodulation Distortion		ITU-R standard, f _{IN} = 19kHz/20kHz, V _{IN} = -3dBFS		-65		dB	
Output Noise	e _N	A-weighted		21.5		μV _{RMS}	
Dynamic Range	DR	Z _L = 8Ω + 33μH, measured using EIAJ method, -60dBFS output signal at 1kHz referenced to output power at 1%THD+N, A-weighted		117.8		dB	
CLASS-DG AMPLIFIER / POWER-SUPPLY RIPPLE REJECTION							
VBAT Supply DC Rejection	PSRR	V _{VBAT} = 3.0V to 5.5V	66	85		dB	
VBAT Supply Rejection AC	PSRR	V _{RIPPLE} = 100mV _{P-P}	f _{RIPPLE} = 217Hz	85		dB	
			f _{RIPPLE} = 1kHz	85			
			f _{RIPPLE} = 20kHz	70			
PVDD Supply DC Rejection	PSRR	SPK_MODE = 0x1 (PVDD mode)	V _{PVDD} = 3.0V to 28V	65	85	dB	

Electrical Characteristics (continued)

(V_{BAT} = 5.0V, V_{PVDD} = 24V, V_{AVDD} = 1.8V, V_{DVDD} = 1.8V, C_{BAT} = 1x10μF, 1x0.1μF, C_{PVDD} = 1x220μF, 2x10μF, 2x0.1μF, C_{AVDD} = 1μF, C_{DVDD} = 1μF, C_{BOOTP} = 0.1μF, C_{BOOTN} = 0.1μF, Z_{SPK} = Open, f_s = 48kHz, AC Measurement Bandwidth = 20Hz to 20kHz, SPK_GAIN_MAX = 0x12 (24dB), Data Width = 24-bit, SPK_MODE = 0x0 (DG), T_A = T_{MIN} to T_{MAX} unless otherwise noted. Typical values are at T_A = +25°C (Note 2))

PARAMETER	SYMBOL	CONDITIONS		MIN	TYP	MAX	UNITS
PVDD Supply Rejection AC	PSRR	SPK_MODE = 0x1 (PVDD mode), V _{RIPPLE} = 100mV _{p-p}	f _{RIPPLE} = 217Hz		80		dB
			f _{RIPPLE} = 1kHz		80		
		SPK_MODE = 0x1 (PVDD Mode), V _{RIPPLE} = 100mV _{p-p}	f _{RIPPLE} = 20kHz		70		
AVDD Supply DC Rejection	PSRR	V _{AVDD} = 1.71V to 1.89V			90		dB
AVDD Supply Rejection AC	PSRR	V _{RIPPLE} = 100mV _{p-p}	f _{RIPPLE} = 217Hz		90		dB
			f _{RIPPLE} = 1kHz		90		
			f _{RIPPLE} = 20kHz		60		
DVDD Supply DC Rejection	PSRR	V _{DVDD} = 1.71V to 1.89V			90		dB
DVDD Supply Rejection AC	PSRR	V _{RIPPLE} = 100mV _{p-p}	f _{RIPPLE} = 217Hz		90		dB
			f _{RIPPLE} = 1kHz		90		
			f _{RIPPLE} = 20kHz		68		
CLASS-DG AMPLIFIER / POWER-SUPPLY INTERMODULATION							
Power-Supply Intermodulation		f _{IN} = 1kHz, P _{OUT} = 400mW	V _{BAT} , f _{RIPPLE} = 217Hz, V _{RIPPLE} = 100mV _{p-p}		-75		dB
			V _{PVDD} , f _{RIPPLE} = 217Hz, V _{RIPPLE} = 100mV _{p-p}		-75		
			V _{AVDD} , f _{RIPPLE} = 217Hz, V _{RIPPLE} = 100mV _{p-p}		-67		
			V _{DVDD} , f _{RIPPLE} = 217Hz, V _{RIPPLE} = 100mV _{p-p}		-75		
Output Switching Frequency			TRI_FSW2X_MODE = 0, constant across all sample rates		320		kHz
			TRI_FSW2X_MODE = 1, constant across all sample rates		620		
Frequency Response Deviation			Across the bandwidth 20Hz to 20kHz referenced to f _{IN} = 1kHz		±0.25		dB
Gain Error	A _{ERROR}			-0.5		+0.5	dB
Channel-to-Channel Phase Error			Output phase shift between multiple devices from 20Hz to 20kHz, across all sample rates and DAI operating modes		1		°
Minimum Load Resistance					3.2		Ω

Electrical Characteristics (continued)

(V_{VBAT} = 5.0V, V_{PVDD} = 24V, V_{AVDD} = 1.8V, V_{DVDD} = 1.8V, C_{VBAT} = 1x10μF, 1x0.1μF, C_{PVDD} = 1x220μF, 2x10μF, 2x0.1μF, C_{AVDD} = 1μF, C_{DVDD} = 1μF, C_{VBOOTP} = 0.1μF, C_{VBOOTN} = 0.1μF, Z_{SPK} = Open, f_s = 48kHz, AC Measurement Bandwidth = 20Hz to 20kHz, SPK_GAIN_MAX = 0x12 (24dB), Data Width = 24-bit, SPK_MODE = 0x0 (DG), T_A = T_{MIN} to T_{MAX} unless otherwise noted. Typical values are at T_A = +25°C (Note 2))

PARAMETER	SYMBOL	CONDITIONS	MIN	TYP	MAX	UNITS
Minimum Load Inductance		In series with a 3.2Ω load		0		μH
Maximum Load Inductance		In series with a 3.2Ω load		470		μH
Current Limit	I _{LIM}	PVDD mode	8.0	9.0		A
SPEAKER VOLTAGE ADC						
Resolution				16		Bits
Sample Rate	f _{S_VSNSADC}		8		192	kHz
Voltage Range	V _{SPK}			±30		V
Dynamic Range	DNR	f _{IN} = 1kHz, AC measurement bandwidth = 20Hz to 20kHz, unweighted		84		dB
Total Harmonic Distortion + Noise	THD+N	f _{IN} = 1kHz, V _{SPK} = 8V _{RMS}		-65		dB
Differential Mode Gain		T _A = +25°C	0.98		1.02	
Differential Mode Gain Variability		Across supplies, T _A = -40°C to +85°C	-1		+1	%
Common Mode Gain		T _A = +25°C (Note 3)			-45	dB
DC Offset Voltage		DC blocking filter enabled (Note 3)	-0.3		+0.3	mV
		DC blocking filter disabled, PVDD = 16V, PVDD Mode, T _A = +25°C	-15		+15	
DC Offset Variability		Across supplies, T _A = -40°C to +85°C		±15		mV
Highpass Cutoff Frequency		-3dB limit across all sample rates			2	Hz
SPEAKER VOLTAGE ADC / DIGITAL FILTER CHARACTERISTICS (f_S < 50kHz) (Note 5)						
Passband Ripple		f _{IN} < f _{PLP} , referenced to signal level at 1kHz	-0.225		+0.225	dB
Lowpass Filter Cutoff Frequency	f _{PLP}		0.445 x f _S			Hz
		Droop < -3dB	0.455 x f _S			
Lowpass Filter Stopband Frequency	f _{SLP}	-40dB limit			0.58 x f _S	Hz
Lowpass Filter Stopband Attenuation			40			dB
Group Delay		f _{IN} = 1kHz		8		Samples
SPEAKER VOLTAGE ADC / DIGITAL FILTER CHARACTERISTICS (f_S > 50kHz) (Note 5)						
Passband Ripple	δ _P	I _{VADC_WBAND_FILT_EN} = 0, f _{IN} ≤ f _{PLP} , referenced to signal level at 1kHz	-0.225		+0.225	dB

Electrical Characteristics (continued)

(V_{VBAT} = 5.0V, V_{PVDD} = 24V, V_{AVDD} = 1.8V, V_{DVDD} = 1.8V, C_{VBAT} = 1x10μF, 1x0.1μF, C_{PVDD} = 1x220μF, 2x10μF, 2x0.1μF, C_{AVDD} = 1μF, C_{DVDD} = 1μF, C_{VBOOTP} = 0.1μF, C_{VBOOTN} = 0.1μF, Z_{SPK} = Open, f_s = 48kHz, AC Measurement Bandwidth = 20Hz to 20kHz, SPK_GAIN_MAX = 0x12 (24dB), Data Width = 24-bit, SPK_MODE = 0x0 (DG), T_A = T_{MIN} to T_{MAX} unless otherwise noted. Typical values are at T_A = +25°C (Note 2))

PARAMETER	SYMBOL	CONDITIONS		MIN	TYP	MAX	UNITS
Lowpass Filter Cutoff Frequency	f _{PLP}	IVADC_WBAND_F ILT_EN = 0	Ripple < δ _p , 88.2kHz ≤ f _S ≤ 96kHz	0.227 x			Hz
			Droop < -3dB, 88.2kHz ≤ f _S ≤ 96kHz	0.31 x			
	f _{PLP}		Ripple < δ _p , 176.4kHz ≤ f _S ≤ 192kHz	0.136 x			
			Droop < -3dB, 176.4kHz ≤ f _S ≤ 192kHz	0.189 x			
Lowpass Filter Stopband Frequency	f _{SLP}	IVADC_WBAND_F ILT_EN = 0	-40dB limit			0.48 x f _S	Hz
Lowpass Filter Stopband Attenuation		IVADC_WBAND_FILTER_EN = 0		40			dB
Group Delay		IVADC_WBAND_F ILT_EN = 0	f _{IN} = 1kHz		10		Samples
SPEAKER VOLTAGE ADC / DIGITAL FILTER CHARACTERISTICS (f_s > 50kHz) (Note 5)							
Passband Ripple		IVADC_WBAND_FILTER_EN = 1, f _{IN} ≤ f _{PLP} , referenced to signal level at 1kHz		-0.5		+0.5	dB
Lowpass Filter Cutoff Frequency	f _{PLP}	IVADC_WBAND_F ILT_EN = 1	Ripple < δ _p , 88.2kHz ≤ f _S ≤ 96kHz	0.459 x			Hz
			Droop < -3dB, 88.2kHz ≤ f _S ≤ 96kHz	0.475 x			
	f _{PLP}		Ripple < δ _p , 176.4kHz ≤ f _S ≤ 192kHz	0.227 x			
			Droop < -3dB, 176.4kHz ≤ f _S ≤ 192kHz	0.31 x			
Lowpass Filter Stopband Frequency	f _{SLP}	IVADC_WBAND_F ILT_EN = 1	-40dB limit, 88.2kHz ≤ f _S ≤ 96kHz			0.58 x f _S	Hz
			-40dB limit, 176.4kHz ≤ f _S ≤ 192kHz			0.489 x f _S	
Lowpass Filter Stopband Attenuation		IVADC_WBAND_FILTER_EN = 1		40			dB
Group Delay		IVADC_WBAND_F ILT_EN = 1	f _{IN} = 1kHz		10		Samples
SPEAKER CURRENT ADC							
Resolution					16		Bits

Electrical Characteristics (continued)

(V_{VBAT} = 5.0V, V_{PVDD} = 24V, V_{AVDD} = 1.8V, V_{DVDD} = 1.8V, C_{VBAT} = 1x10μF, 1x0.1μF, C_{PVDD} = 1x220μF, 2x10μF, 2x0.1μF, C_{AVDD} = 1μF, C_{DVDD} = 1μF, C_{VBOOTP} = 0.1μF, C_{VBOOTN} = 0.1μF, Z_{SPK} = Open, f_s = 48kHz, AC Measurement Bandwidth = 20Hz to 20kHz, SPK_GAIN_MAX = 0x12 (24dB), Data Width = 24-bit, SPK_MODE = 0x0 (DG), T_A = T_{MIN} to T_{MAX} unless otherwise noted. Typical values are at T_A = +25°C (Note 2))

PARAMETER	SYMBOL	CONDITIONS	MIN	TYP	MAX	UNITS
Sample Rate	f _{S_ISNSADC}		8		192	kHz
Current Range	I _{SPK}			±8.3		A
Dynamic Range	DNR	f _{IN} = 1kHz, AC measurement bandwidth = 20Hz to 20kHz, unweighted		82		dB
Total Harmonic Distortion + Noise	THD+N	f _{IN} = 1kHz, I _{SPK} = 1A _{RMS}		-64		dB
Differential Mode Gain		T _A = +25°C	0.97		1.03	
Differential Mode Gain Variability		Across supplies, T _A = -40°C to +85°C (Note 3)	-2.5		+2.5	%
Common Mode Gain		T _A = +25°C			-46	dB
Highpass Cutoff Frequency		-3dB limit, across all sample rates			2	Hz
DC Offset Current		DC blocking filter enabled, T _A = +25°C	-0.16		0.16	mA
		DC blocking filter disabled, PVDD = 16V, PVDD mode, T _A = +25°C	-4.5		+4.5	
DC Offset Variability		Across supplies, T _A = -40°C to +85°C, DC blocking filter disabled		±12		mA
Voltage and Current Accuracy Drift Tracking		T _A = 0°C to +85°C, relative to +25°C		0.4		%
SPEAKER CURRENT ADC / DIGITAL FILTER CHARACTERISTICS (f_S < 50kHz) (Note 5)						
Passband Ripple		f _{IN} ≤ f _{PLP}	-0.225		+0.225	dB
Lowpass Filter Cutoff Frequency	f _{PLP}		0.445 x f _S			Hz
		-3dB limit	0.455 x f _S			
Lowpass Filter Stopband Frequency	f _{SLP}	-40dB limit			0.58 x f _S	Hz
Lowpass Filter Stopband Attenuation			40			dB
Max Group Delay		f _{IN} = 1kHz		8		Samples
SPEAKER CURRENT ADC / DIGITAL FILTER CHARACTERISTICS (f_S > 50kHz) (Note 5)						
Passband Ripple	δ _P	IVADC_WBAND_FILT_EN = 0, f _{IN} ≤ f _{PLP}	-0.225		+0.225	dB

Electrical Characteristics (continued)

(V_{VBAT} = 5.0V, V_{PVDD} = 24V, V_{AVDD} = 1.8V, V_{DVDD} = 1.8V, C_{VBAT} = 1x10μF, 1x0.1μF, C_{PVDD} = 1x220μF, 2x10μF, 2x0.1μF, C_{AVDD} = 1μF, C_{DVDD} = 1μF, C_{VBOOTP} = 0.1μF, C_{VBOOTN} = 0.1μF, Z_{SPK} = Open, f_s = 48kHz, AC Measurement Bandwidth = 20Hz to 20kHz, SPK_GAIN_MAX = 0x12 (24dB), Data Width = 24-bit, SPK_MODE = 0x0 (DG), T_A = T_{MIN} to T_{MAX} unless otherwise noted. Typical values are at T_A = +25°C (Note 2))

PARAMETER	SYMBOL	CONDITIONS	MIN	TYP	MAX	UNITS
Lowpass Filter Cutoff Frequency	f _{PLP}	IVADC_WBAND_F ILT_EN = 0	Ripple < δ _p , 88.2kHz ≤ f _S ≤ 96kHz	0.227 x f _S		Hz
			Droop < -3dB, 88.2kHz ≤ f _S ≤ 96kHz	0.31 x f _S		
			Ripple < δ _p , 176.4kHz ≤ f _S ≤ 192kHz	0.136 x f _S		
			Droop < -3dB, 176.4kHz ≤ f _S ≤ 192kHz	0.189 x f _S		
Lowpass Filter Stopband Frequency	f _{SLP}	IVADC_WBAND_F ILT_EN = 0	-40dB limit, 88.2kHz ≤ f _S ≤ 96kHz		0.48 x f _S	Hz
Lowpass Filter Stopband Attenuation		IVADC_WBAND_FILTER_EN = 0		40		dB
Max Group Delay		IVADC_WBAND_FILTER_EN = 0, f _{IN} = 1kHz		10		Samples
SPEAKER CURRENT ADC / DIGITAL FILTER CHARACTERISTICS (f_S > 50kHz) (Note 5)						
Passband Ripple		IVADC_WBAND_FILTER_EN = 1, f _{IN} ≤ f _{PLP}	-0.5		+0.5	dB
Lowpass Filter Cutoff Frequency	f _{PLP}	IVADC_WBAND_F ILT_EN = 1	Ripple < δ _p , 88.2kHz ≤ f _S ≤ 96kHz	0.459 x f _S		Hz
			-3dB limit, 88.2kHz ≤ f _S ≤ 96kHz	0.475 x f _S		
			Ripple < δ _p , 176.4kHz ≤ f _S ≤ 192kHz	0.227 x f _S		
			-3dB limit, 176.4kHz ≤ f _S ≤ 192kHz	0.31 x f _S		
Lowpass Filter Stopband Frequency	f _{SLP}	IVADC_WBAND_F ILT_EN = 1	-40dB limit, 88.2kHz ≤ f _S ≤ 96kHz		0.58 x f _S	Hz
			-40dB limit, 176.4kHz ≤ f _S ≤ 192kHz		0.489 x f _S	
Lowpass Filter Stopband Attenuation		IVADC_WBAND_FILTER_EN = 1		40		dB
Max Group Delay		IVADC_WBAND_FILTER_EN = 1, f _{IN} = 1kHz		10		Samples
MEASUREMENT ADC						
Resolution				9		Bits

Electrical Characteristics (continued)

(V_{BAT} = 5.0V, V_{PVDD} = 24V, V_{AVDD} = 1.8V, V_{DVDD} = 1.8V, C_{VBAT} = 1x10μF, 1x0.1μF, C_{PVDD} = 1x220μF, 2x10μF, 2x0.1μF, C_{AVDD} = 1μF, C_{DVDD} = 1μF, C_{VBOOTP} = 0.1μF, C_{VBOOTN} = 0.1μF, Z_{SPK} = Open, f_s = 48kHz, AC Measurement Bandwidth = 20Hz to 20kHz, SPK_GAIN_MAX = 0x12 (24dB), Data Width = 24-bit, SPK_MODE = 0x0 (DG), T_A = T_{MIN} to T_{MAX} unless otherwise noted. Typical values are at T_A = +25°C (Note 2))

PARAMETER	SYMBOL	CONDITIONS	MIN	TYP	MAX	UNITS
PVDD Channel Input Voltage Range			2.7		28	V
PVDD Channel Voltage Resolution				54.7		mV
PVDD Channel Measurement Accuracy		T _A = +25°C (Note 3)	-400		+400	mV
VBAT Channel Input Voltage Range			2.5		5.5	V
VBAT Channel Voltage Resolution				11.4		mV
VBAT Channel Measurement Accuracy		T _A = +25°C (Note 3)	-83		+83	mV
VDDH_SNS Channel Input Voltage Range			2.5		28	V
VDDH_SNS Channel Voltage Resolution				54.7		mV
VDDH_SNS Channel Measurement Accuracy		T _A = +25°C (Note 3)	-400		+400	mV
Thermal Channel Resolution				1		°C
BROWNOUT-PROTECTION ENGINE (BPE)						
BPE Attack Delay Time to Gain Change		MEAS_ADC_OPT_MODE = 0x2, MEAS_ADC_OPT_AVG = 0x0		12		μs
BPE Attack Delay Time to Interrupt				3		μs
THERMAL PROTECTION						
Thermal Shutdown Trigger Point		THERMSHDN_THRESH = 0x64	140	150	160	°C
DIGITAL I/O / INPUT — DIN, BCLK, LRCLK, RESET, ICC, DOUT						
Input Voltage High	V _{IH}		0.7 x V _{DVDD}			V
Input Voltage Low	V _{IL}				0.3 x V _{DVDD}	V
Input Leakage Current			-1		+1	μA
Input Hysteresis	V _{HYS}		75			mV
Maximum Input Capacitance	C _{IN}			10		pF
Internal Pulldown Resistance	R _{PD}	BCLK, LRCLK, DIN, and ICC		3		MΩ
DIGITAL I/O / INPUT — SDA, SCL, ADDR						
Input Voltage High	V _{IH}		0.7 x V _{DVDD}			V

Electrical Characteristics (continued)

($V_{VBAT} = 5.0V$, $V_{PVDD} = 24V$, $V_{AVDD} = 1.8V$, $V_{DVDD} = 1.8V$, $C_{VBAT} = 1 \times 10\mu F$, $1 \times 0.1\mu F$, $C_{PVDD} = 1 \times 220\mu F$, $2 \times 10\mu F$, $2 \times 0.1\mu F$, $C_{AVDD} = 1\mu F$, $C_{DVDD} = 1\mu F$, $C_{VBOOTP} = 0.1\mu F$, $C_{VBOOTN} = 0.1\mu F$, $Z_{SPK} = \text{Open}$, $f_s = 48\text{kHz}$, AC Measurement Bandwidth = 20Hz to 20kHz, $SPK_GAIN_MAX = 0 \times 12$ (24dB), Data Width = 24-bit, $SPK_MODE = 0 \times 0$ (DG), $T_A = T_{MIN}$ to T_{MAX} unless otherwise noted. Typical values are at $T_A = +25^\circ\text{C}$ (Note 2))

PARAMETER	SYMBOL	CONDITIONS	MIN	TYP	MAX	UNITS
Input Voltage Low	V_{IL}				$0.3 \times V_{DVDD}$	V
Input Leakage Current		$T_A = +25^\circ\text{C}$, input high	-1		+1	μA
Input Hysteresis	V_{HYS}		75			mV
Maximum Input Capacitance	C_{IN}			10		pF
DIGITAL I/O / OPEN-DRAIN OUTPUT — SDA, IRQ, LV_EN						
Output Voltage Low	V_{OL}	$I_{SINK} = 3\text{mA}$			0.4	V
Output High Leakage Current	I_{OH}	$T_A = +25^\circ\text{C}$	-1		+1	μA
DIGITAL I/O / PUSH-PULL OUTPUT — DOUT, ICC, IRQ						
Output Voltage High	V_{OH}	$I_{OH} = 3\text{mA}$			$V_{DVDD} - 0.3$	V
Output Voltage Low	V_{OL}	$I_{OL} = 3\text{mA}$			0.3	V
Output Current	I_{OH}	Maximum-drive mode		8		mA
		High-drive mode		6		
		Normal-drive mode		4		
		Reduced-drive mode		2		
PCM AUDIO INTERFACE TIMING						
LRCLK Frequency Range	f_{LRCLK}	All DAI operating modes	16		192	kHz
BCLK Frequency Range	f_{BCLK}	I ² S/left-justified modes	1.024		12.288	MHz
		TDM mode	1.024		24.576	
BCLK Duty Cycle	DC		45		55	%
BCLK Period	t_{BCLK}	I ² S/left-justified only	80			ns
		TDM mode	40			
Maximum BCLK Input Low Frequency Jitter		Maximum allowable jitter before a -20dBFS, 20kHz input has a 1dB reduction in THD+N, RMS jitter $\leq 40\text{kHz}$		0.2		ns
Maximum BCLK Input High Frequency Jitter		Maximum allowable jitter before a -60dBFS, 20kHz input has a 1dB reduction in THD+N, RMS jitter $> 40\text{kHz}$		1		ns
PCM AUDIO INTERFACE TIMING / INTERFACE TIMING						
LRCLK to BCLK Active Edge Setup Time	$t_{SYNCSET}$		4			ns
LRCLK to BCLK Active Edge Hold Time	$t_{SYNHOLD}$		4			ns
DIN to BCLK Active Edge Setup Time	t_{SETUP}		4			ns
DIN to BCLK Active Edge Hold Time	t_{HOLD}		4			ns

Electrical Characteristics (continued)

(V_{BAT} = 5.0V, V_{PVDD} = 24V, V_{AVDD} = 1.8V, V_{DVDD} = 1.8V, C_{VBAT} = 1x10μF, 1x0.1μF, C_{PVDD} = 1x220μF, 2x10μF, 2x0.1μF, C_{AVDD} = 1μF, C_{DVDD} = 1μF, C_{VBOOTP} = 0.1μF, C_{VBOOTN} = 0.1μF, Z_{SPK} = Open, f_s = 48kHz, AC Measurement Bandwidth = 20Hz to 20kHz, SPK_GAIN_MAX = 0x12 (24dB), Data Width = 24-bit, SPK_MODE = 0x0 (DG), T_A = T_{MIN} to T_{MAX} unless otherwise noted. Typical values are at T_A = +25°C (Note 2))

PARAMETER	SYMBOL	CONDITIONS	MIN	TYP	MAX	UNITS
DIN Frame Delay after LRCLK Edge		Measured in number of BCLK cycles, set by selected TDM mode	0		2	cycles
PCM AUDIO INTERFACE TIMING / INTERFACE TIMING / PCM DATA OUTPUT (DOUT)						
BCLK Inactive Edge to DOUT Delay	t _{CLKTX}				14	ns
BCLK Active Edge to DOUT Hi-Z Delay	t _{HIZ}		4		18	ns
BCLK Inactive Edge to DOUT Active Delay	t _{ACTV}		0		14	ns
PCM AUDIO INTERFACE TIMING / INTERFACE TIMING / INTERCHIP COMMUNICATION (ICC)						
ICC/DOUT to BCLK Active Edge Setup Time	t _{SETUP}		4			ns
ICC/DOUT to BCLK Active Edge Hold Time	t _{HOLD}		4			ns
BCLK Inactive Edge to ICC Delay	t _{CLKTX}				14	ns
BCLK Active Edge to ICC Hi-Z Delay	t _{HIZ}		4		18	ns
BCLK Inactive Edge to ICC Active Delay	t _{ACTV}		0		14	ns
I²C INTERFACE TIMING						
Serial Clock Frequency	f _{SCL}				1000	kHz
Bus Free Time Between STOP and START Conditions	t _{BUF}		0.5			μs
Hold Time (Repeated) START Condition	t _{HD,STA}		0.26			μs
SCL Pulse Width Low	t _{LOW}		0.5			μs
SCL Pulse Width High	t _{HIGH}		0.26			μs
Setup Time for a Repeated START Condition	t _{SU,STA}		0.26			μs
Data Hold Time	t _{HD,DAT}		0		450	ns
Data Setup Time	t _{SU,DAT}		50			ns
SDA and SCL Receiving Rise Time	t _R		20		120	ns
SDA and SCL Receiving Fall Time	t _F				20 x V _{DVDD} /5 .5V	ns
SDA Transmitting Fall Time	t _F				20 x V _{DVDD} /5 .5V	ns

Electrical Characteristics (continued)

($V_{VBAT} = 5.0V$, $V_{PVDD} = 24V$, $V_{AVDD} = 1.8V$, $V_{DVDD} = 1.8V$, $C_{VBAT} = 1 \times 10\mu F$, $1 \times 0.1\mu F$, $C_{PVDD} = 1 \times 220\mu F$, $2 \times 10\mu F$, $2 \times 0.1\mu F$, $C_{AVDD} = 1\mu F$, $C_{DVDD} = 1\mu F$, $C_{VBOOTP} = 0.1\mu F$, $C_{VBOOTN} = 0.1\mu F$, $Z_{SPK} = \text{Open}$, $f_s = 48\text{kHz}$, AC Measurement Bandwidth = 20Hz to 20kHz, $SPK_GAIN_MAX = 0 \times 12$ (24dB), Data Width = 24-bit, $SPK_MODE = 0 \times 0$ (DG), $T_A = T_{MIN}$ to T_{MAX} unless otherwise noted. Typical values are at $T_A = +25^\circ C$ (*Note 2*))

PARAMETER	SYMBOL	CONDITIONS	MIN	TYP	MAX	UNITS
Setup Time for STOP Condition	$t_{SU,STO}$		0.26			μs
Bus Capacitance	C_B				550	pF
Pulse Width of Suppressed Spike	t_{SP}		0		50	ns
RESET TIMING						
\overline{RESET} Low	t_{RESET_LOW}	Minimum low time for \overline{RESET} to ensure device enters hardware shutdown		0.4		μs
Release from \overline{RESET}	$t_{I^2C_READY}$	Time from $\overline{RESET} = 1$ to I^2C -communication available (software shutdown)			1.5	ms

Note 1: Package thermal resistances were obtained using the method described in JEDEC specification JESD51-7, using a four-layer board. For detailed information on package thermal considerations, refer to www.analog.com/en/technical-articles/thermal-characterization-of-ic-packages.

Note 2: 100% production tested at $T_A = +25^\circ C$. Specifications over temperature limits are guaranteed by design. Typical values are based on 1 sigma characterization data unless otherwise noted.

Note 3: Minimum and/or maximum limit is guaranteed by design and by statistical analysis of device characterization data. The specification is not guaranteed by production testing.

Note 4: Assumes device is fully programmed ($SPK_EN = 1$) and $EN = 1$ is the last I^2C write in the sequence.

Note 5: Digital filter performance is invariant over temperature and is production tested at $T_A = +25^\circ C$.

Note 6: Applies to all transitions in/out of full operation with noise gate enabled/disabled. Does not include state transitions due to fault conditions.

Typical Operating Characteristics

($V_{VBAT} = 5.0V$, $V_{DVDD} = 1.8V$, $V_{AVDD} = 1.8V$, $V_{GND} = 0V$, $V_{PGND} = 0V$, $V_{PVDD} = 24V$, $C_{VBAT} = 10\mu F + 0.1\mu F$, $C_{PVDD} = 0.1\mu F + 10\mu F + 220\mu F$, $C_{DVDD} = 1\mu F$, $C_{AVDD} = 1\mu F$, $C_{VBOOT_P} = 0.1\mu F$, $C_{VBOOT_N} = 0.1\mu F$, $A_V = 24dB$, $Z_{SPK} = \infty$ between OUTP and OUTN, AC Measurement Bandwidth = 20Hz to 20kHz, $f_S = 48kHz$, 24-bit data, $f_{CLK} = 3.072MHz$. Typical values are at $T_A = +25^\circ C$)

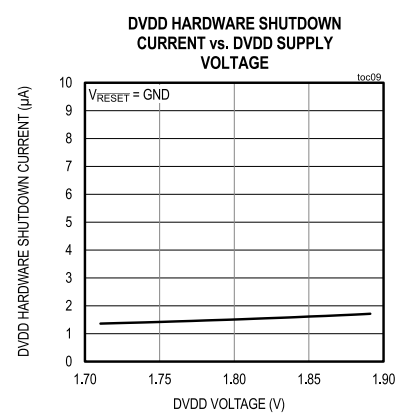
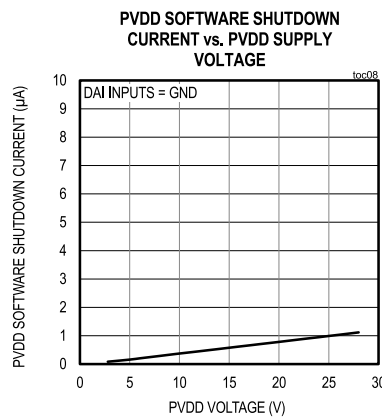
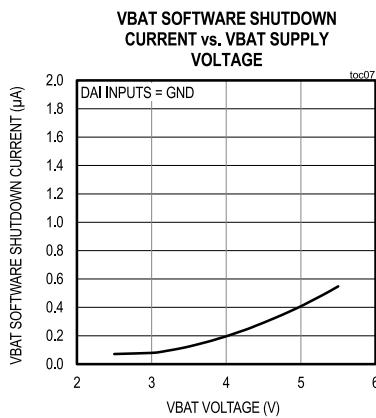
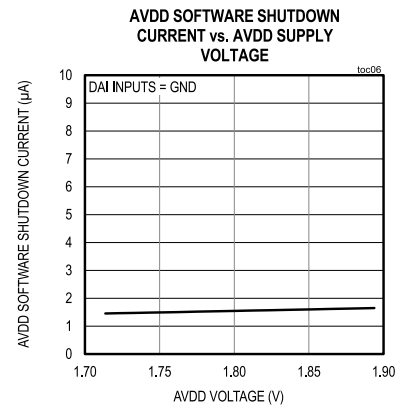
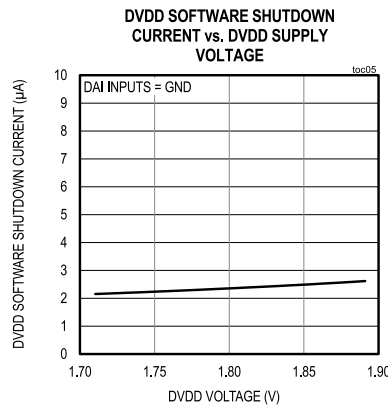
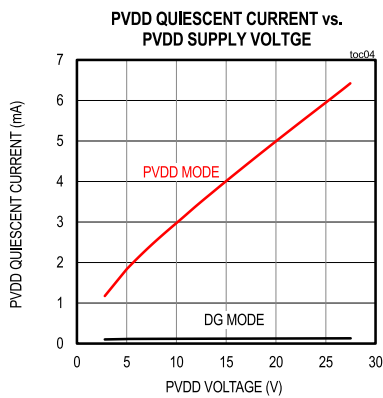
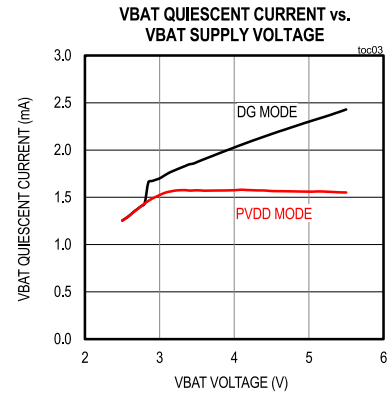
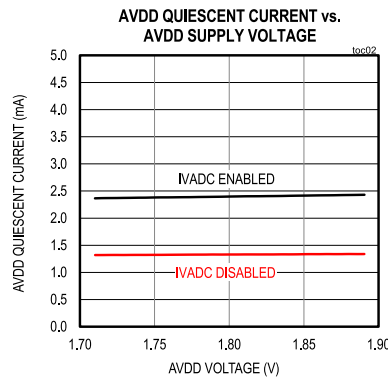
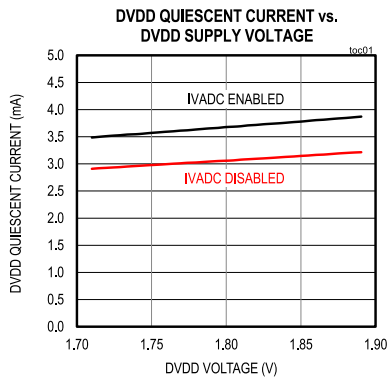

Typical Operating Characteristics (continued)

($V_{VBAT} = 5.0V$, $V_{DVDD} = 1.8V$, $V_{AVDD} = 1.8V$, $V_{GND} = 0V$, $V_{PGND} = 0V$, $V_{PVDD} = 24V$, $C_{VBAT} = 10\mu F + 0.1\mu F$, $C_{PVDD} = 0.1\mu F + 10\mu F + 220\mu F$, $C_{DVDD} = 1\mu F$, $C_{AVDD} = 1\mu F$, $C_{VBOOT_P} = 0.1\mu F$, $C_{VBOOT_N} = 0.1\mu F$, $A_V = 24dB$, $Z_{SPK} = \infty$ between OUTP and OUTN, AC Measurement Bandwidth = 20Hz to 20kHz, $f_S = 48kHz$, 24-bit data, $f_{BCLK} = 3.072MHz$. Typical values are at $T_A = +25^\circ C$)

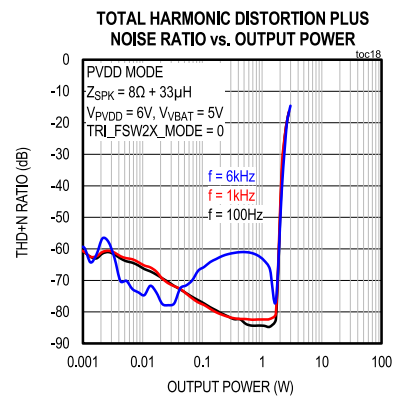
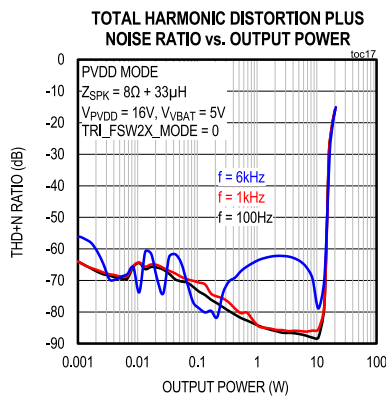
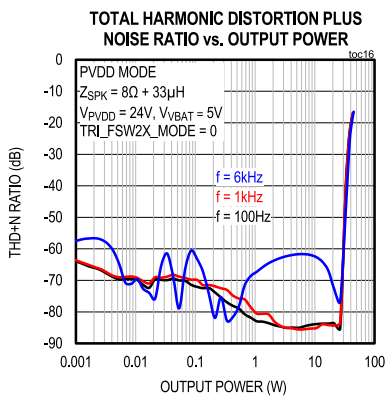
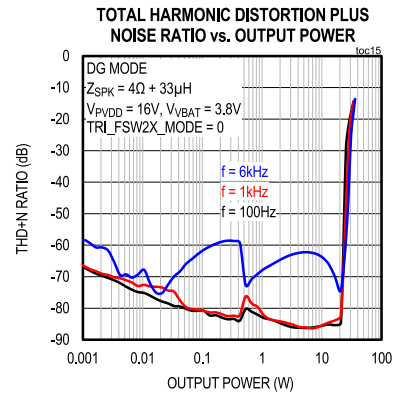
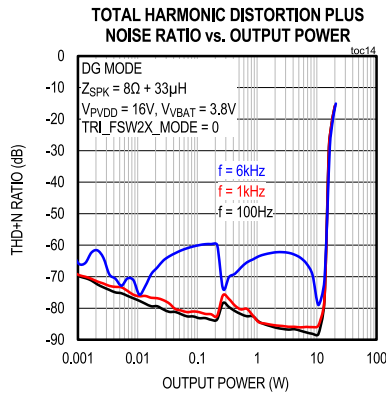
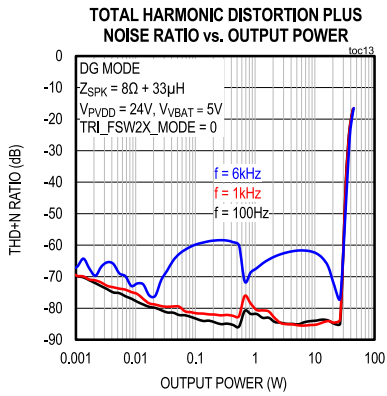
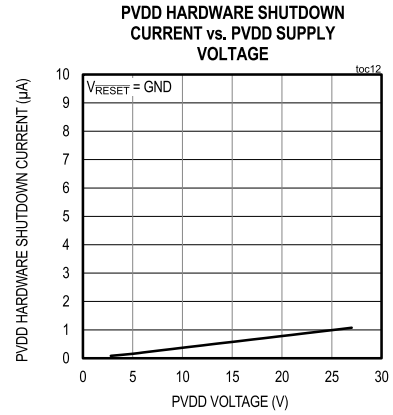
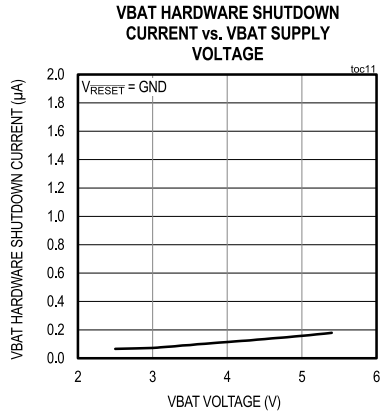
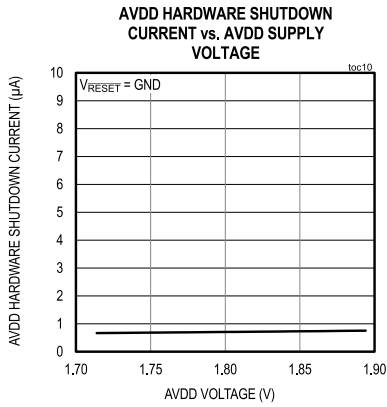

Typical Operating Characteristics (continued)

($V_{VBAT} = 5.0V$, $V_{DVDD} = 1.8V$, $V_{AVDD} = 1.8V$, $V_{GND} = 0V$, $V_{PGND} = 0V$, $V_{PVDD} = 24V$, $C_{VBAT} = 10\mu F + 0.1\mu F$, $C_{PVDD} = 0.1\mu F + 10\mu F + 220\mu F$, $C_{DVDD} = 1\mu F$, $C_{AVDD} = 1\mu F$, $C_{VBOOT_P} = 0.1\mu F$, $C_{VBOOT_N} = 0.1\mu F$, $A_V = 24dB$, $Z_{SPK} = \infty$ between OUTP and OUTN, AC Measurement Bandwidth = 20Hz to 20kHz, $f_S = 48kHz$, 24-bit data, $f_{CLK} = 3.072MHz$. Typical values are at $T_A = +25^\circ C$)

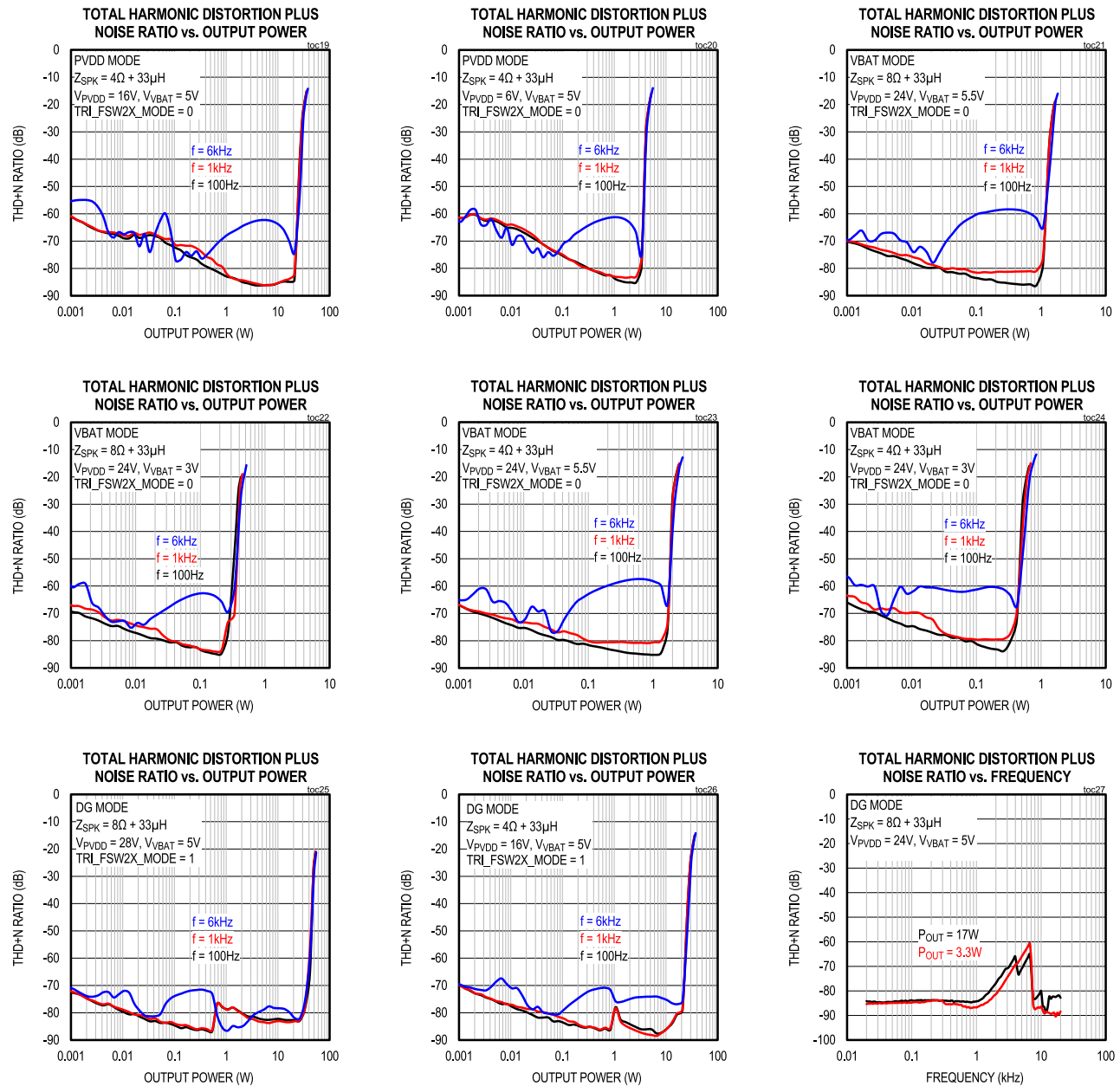

Typical Operating Characteristics (continued)

($V_{VBAT} = 5.0V$, $V_{DVDD} = 1.8V$, $V_{AVDD} = 1.8V$, $V_{GND} = 0V$, $V_{PGND} = 0V$, $V_{PVDD} = 24V$, $C_{VBAT} = 10\mu F + 0.1\mu F$, $C_{PVDD} = 0.1\mu F + 10\mu F + 220\mu F$, $C_{DVDD} = 1\mu F$, $C_{AVDD} = 1\mu F$, $C_{VBOOT_P} = 0.1\mu F$, $C_{VBOOT_N} = 0.1\mu F$, $A_V = 24dB$, $Z_{SPK} = \infty$ between OUTP and OUTN, AC Measurement Bandwidth = 20Hz to 20kHz, $f_S = 48kHz$, 24-bit data, $f_{CLK} = 3.072MHz$. Typical values are at $T_A = +25^\circ C$)

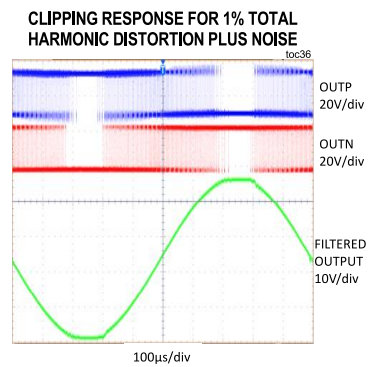
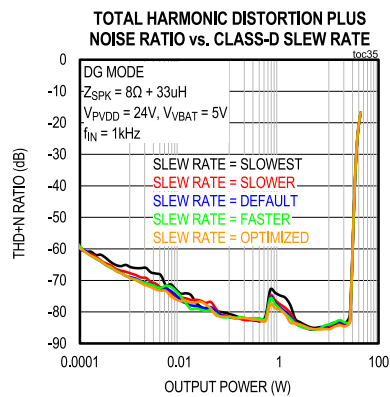
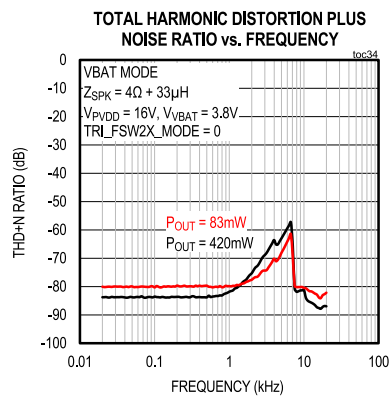
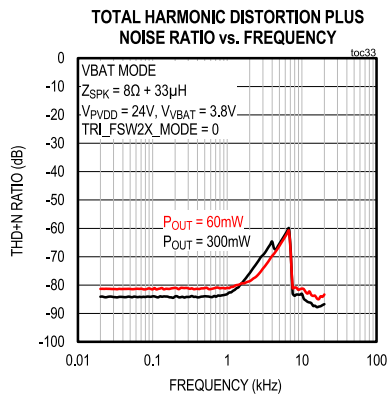
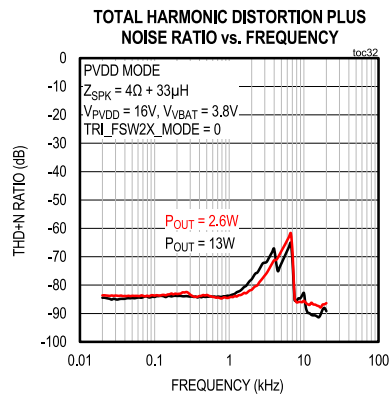
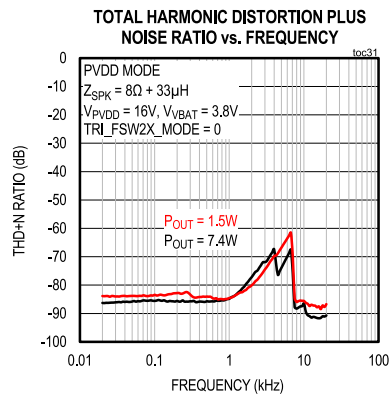
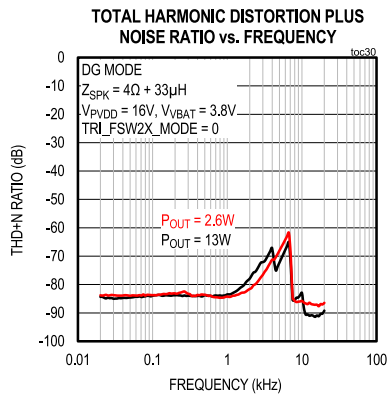
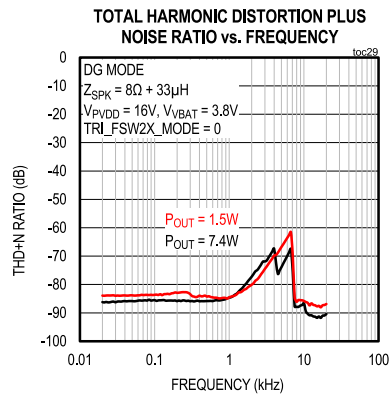
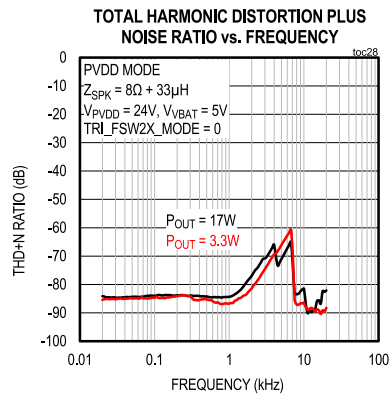

Typical Operating Characteristics (continued)

($V_{VBAT} = 5.0V$, $V_{DVDD} = 1.8V$, $V_{AVDD} = 1.8V$, $V_{GND} = 0V$, $V_{PGND} = 0V$, $V_{PVDD} = 24V$, $C_{VBAT} = 10\mu F + 0.1\mu F$, $C_{PVDD} = 0.1\mu F + 10\mu F + 220\mu F$, $C_{DVDD} = 1\mu F$, $C_{AVDD} = 1\mu F$, $C_{VBOOT_P} = 0.1\mu F$, $C_{VBOOT_N} = 0.1\mu F$, $A_V = 24dB$, $Z_{SPK} = \infty$ between OUTP and OUTN, AC Measurement Bandwidth = 20Hz to 20kHz, $f_S = 48kHz$, 24-bit data, $f_{CLK} = 3.072MHz$. Typical values are at $T_A = +25^\circ C$)

CLIPPING RESPONSE FOR 10% TOTAL HARMONIC DISTORTION PLUS NOISE

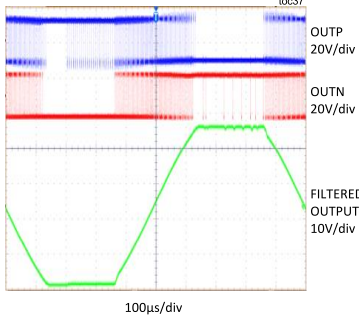

OUTPUT POWER vs. LOAD IMPEDANCE

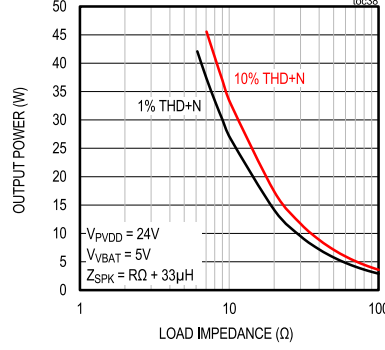

OUTPUT POWER vs. LOAD IMPEDANCE

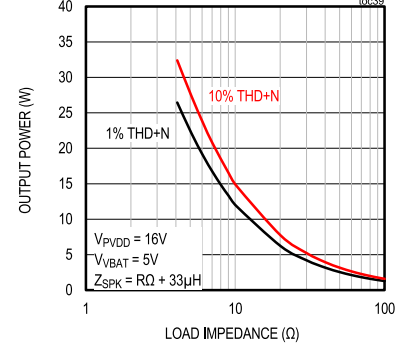

OUTPUT POWER vs. PVDD SUPPLY VOLTAGE

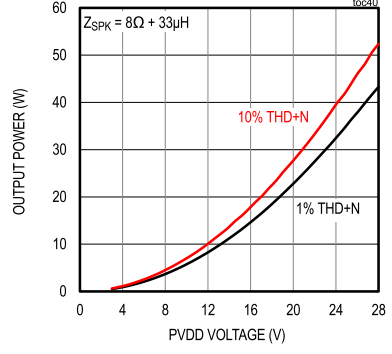

OUTPUT POWER vs. PVDD SUPPLY VOLTAGE

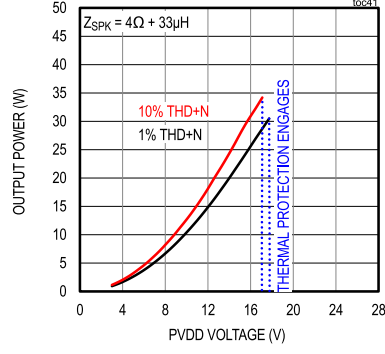

EFFICIENCY vs. OUTPUT POWER

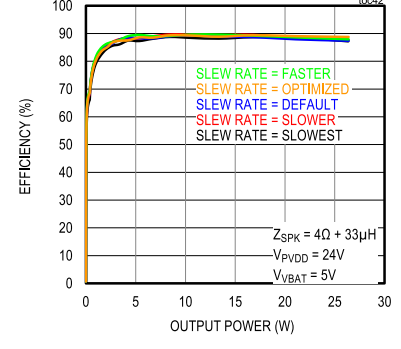

EFFICIENCY vs. OUTPUT POWER

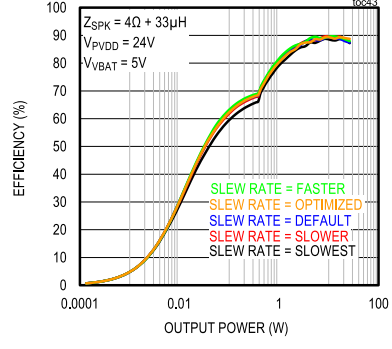

EFFICIENCY vs. OUTPUT POWER

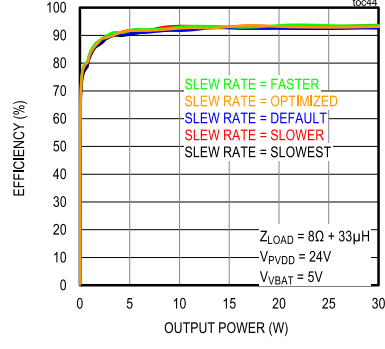

EFFICIENCY vs. OUTPUT POWER

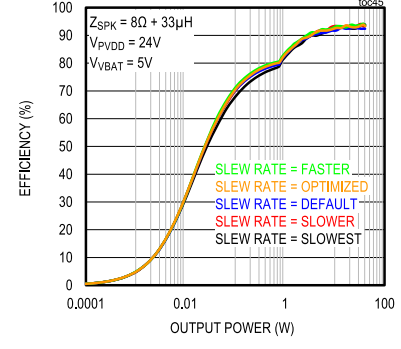

Typical Operating Characteristics (continued)

($V_{VBAT} = 5.0V$, $V_{DVDD} = 1.8V$, $V_{AVDD} = 1.8V$, $V_{GND} = 0V$, $V_{PGND} = 0V$, $V_{PVDD} = 24V$, $C_{VBAT} = 10\mu F + 0.1\mu F$, $C_{PVDD} = 0.1\mu F + 10\mu F + 220\mu F$, $C_{DVDD} = 1\mu F$, $C_{AVDD} = 1\mu F$, $C_{VBOOT_P} = 0.1\mu F$, $C_{VBOOT_N} = 0.1\mu F$, $A_v = 24dB$, $Z_{SPK} = \infty$ between OUTP and OUTN, AC Measurement Bandwidth = 20Hz to 20kHz, $f_S = 48kHz$, 24-bit data, $f_{CLK} = 3.072MHz$. Typical values are at $T_A = +25^\circ C$)

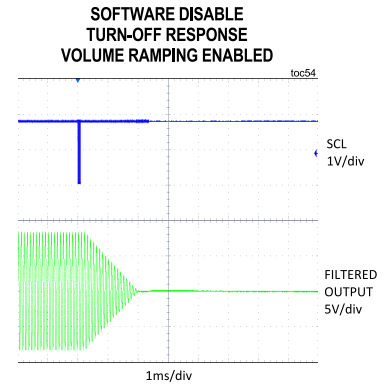
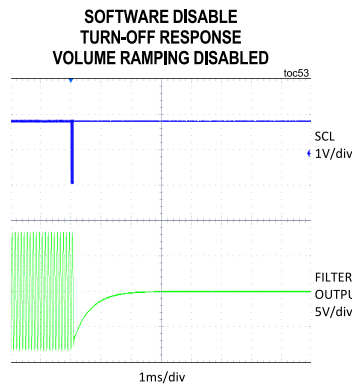
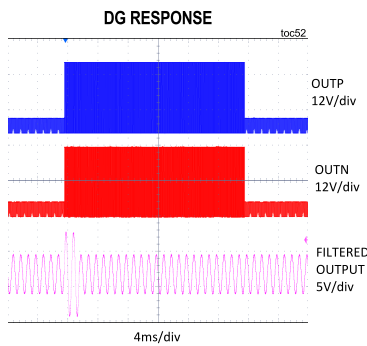
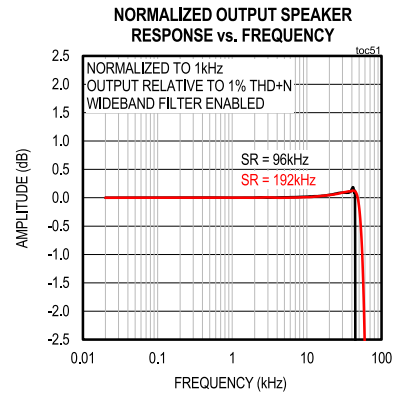
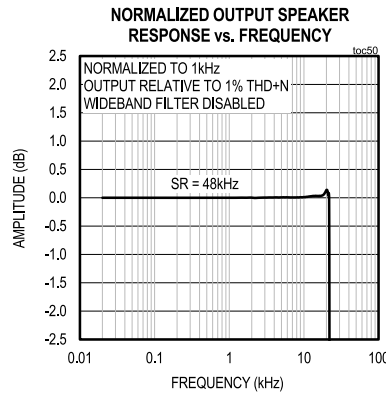
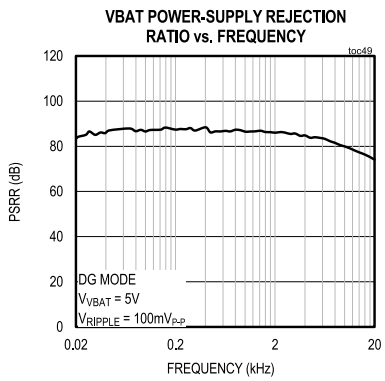
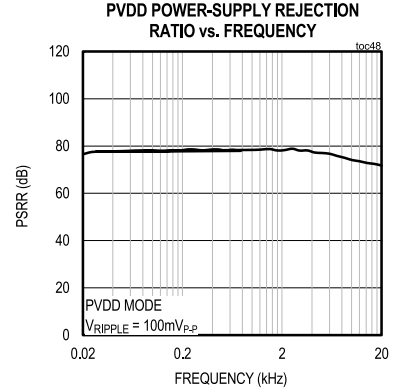
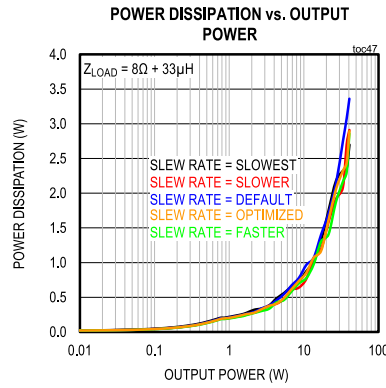
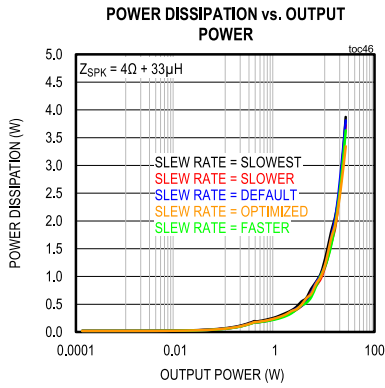

Typical Operating Characteristics (continued)

($V_{BAT} = 5.0V$, $V_{DVDD} = 1.8V$, $V_{AVDD} = 1.8V$, $V_{GND} = 0V$, $V_{PGND} = 0V$, $V_{PVDD} = 24V$, $C_{VBAT} = 10\mu F + 0.1\mu F$, $C_{PVDD} = 0.1\mu F + 10\mu F + 220\mu F$, $C_{DVDD} = 1\mu F$, $C_{AVDD} = 1\mu F$, $C_{VBOOT_P} = 0.1\mu F$, $C_{VBOOT_N} = 0.1\mu F$, $A_v = 24dB$, $Z_{SPK} = \infty$ between OUTP and OUTN, AC Measurement Bandwidth = 20Hz to 20kHz, $f_S = 48kHz$, 24-bit data, $f_{CLK} = 3.072MHz$. Typical values are at $T_A = +25^\circ C$)

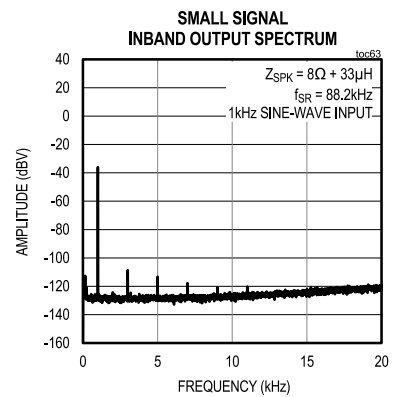
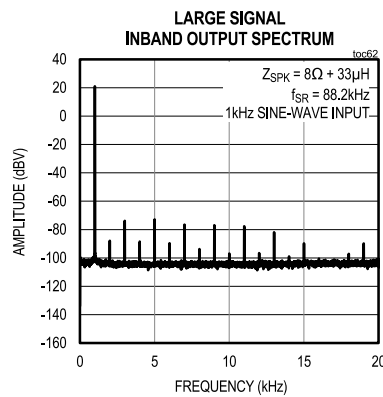
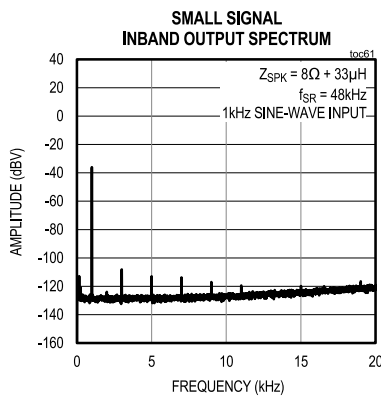
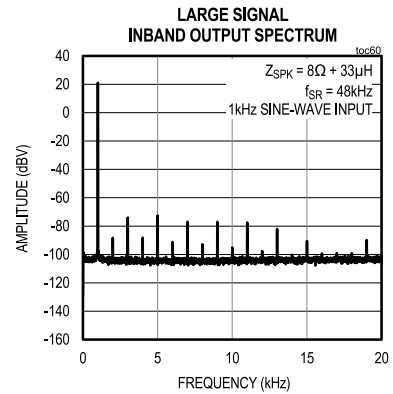
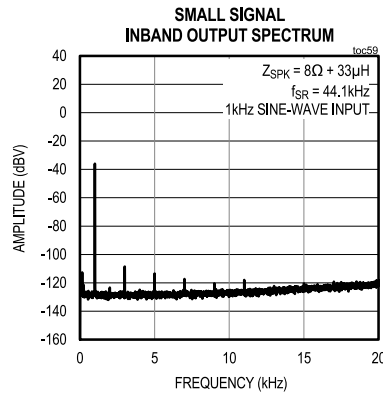
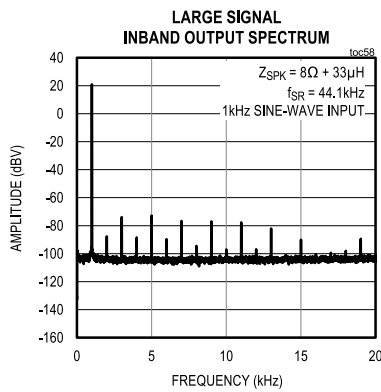
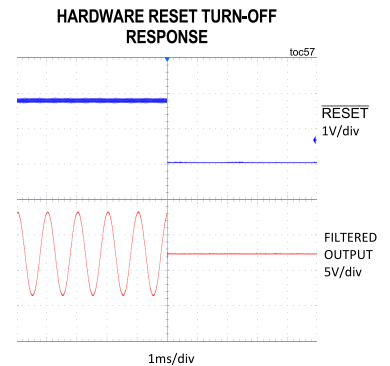
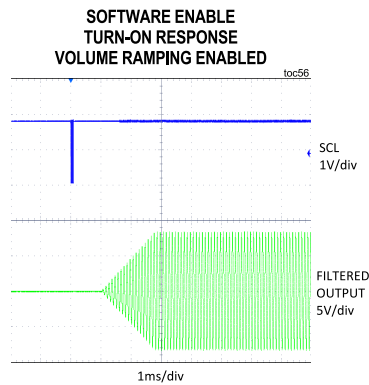
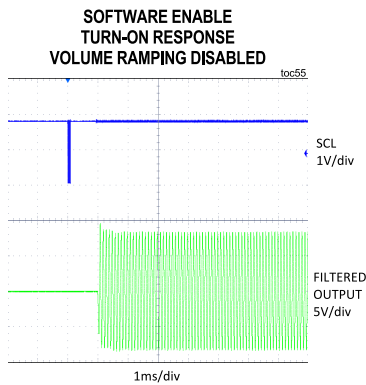

Typical Operating Characteristics (continued)

($V_{BAT} = 5.0V$, $V_{DVDD} = 1.8V$, $V_{AVDD} = 1.8V$, $V_{GND} = 0V$, $V_{PGND} = 0V$, $V_{PVDD} = 24V$, $C_{VBAT} = 10\mu F + 0.1\mu F$, $C_{PVDD} = 0.1\mu F + 10\mu F + 220\mu F$, $C_{DVDD} = 1\mu F$, $C_{AVDD} = 1\mu F$, $C_{VBOOT_P} = 0.1\mu F$, $C_{VBOOT_N} = 0.1\mu F$, $A_V = 24dB$, $Z_{SPK} = \infty$ between OUTP and OUTN, AC Measurement Bandwidth = 20Hz to 20kHz, $f_S = 48kHz$, 24-bit data, $f_{CLK} = 3.072MHz$. Typical values are at $T_A = +25^\circ C$)

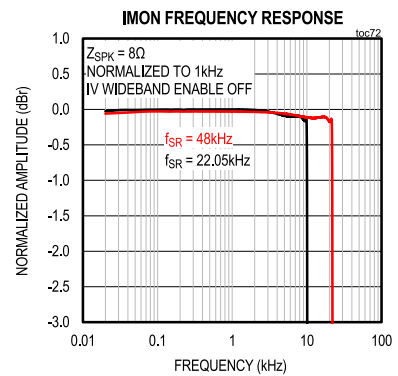
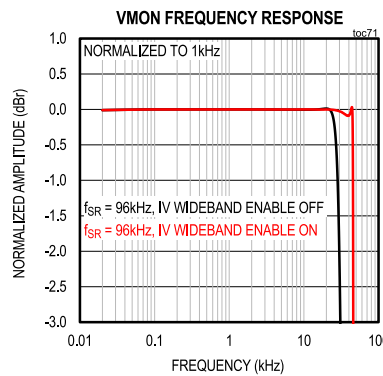
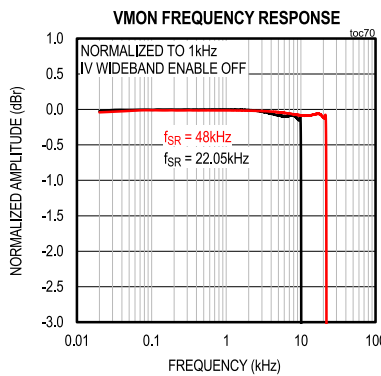
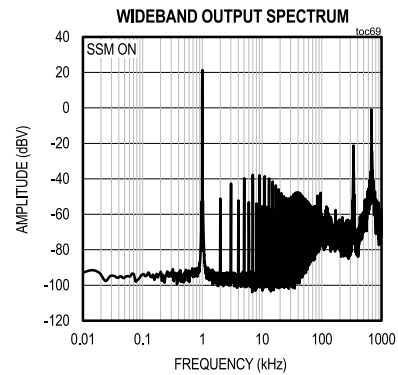
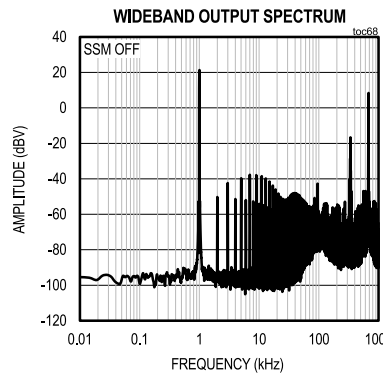
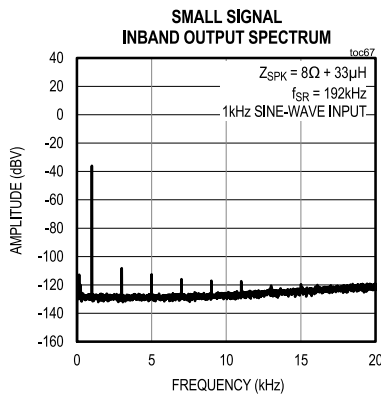
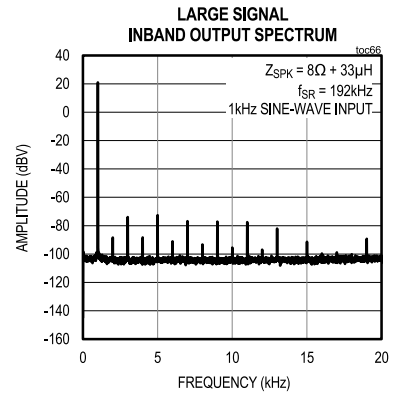
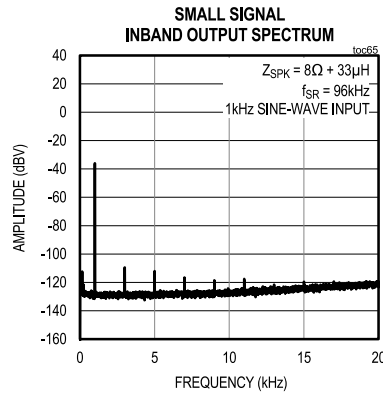
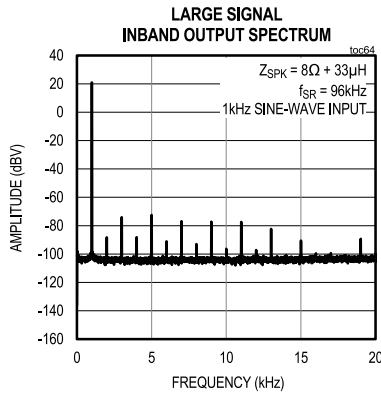

Typical Operating Characteristics (continued)

($V_{BAT} = 5.0V$, $V_{DVDD} = 1.8V$, $V_{AVDD} = 1.8V$, $V_{GND} = 0V$, $V_{PGND} = 0V$, $V_{PVDD} = 24V$, $C_{VBAT} = 10\mu F + 0.1\mu F$, $C_{PVDD} = 0.1\mu F + 10\mu F + 220\mu F$, $C_{DVDD} = 1\mu F$, $C_{AVDD} = 1\mu F$, $C_{VBOOT_P} = 0.1\mu F$, $C_{VBOOT_N} = 0.1\mu F$, $A_V = 24dB$, $Z_{SPK} = \infty$ between OUTP and OUTN, AC Measurement Bandwidth = 20Hz to 20kHz, $f_S = 48kHz$, 24-bit data, $f_{CLK} = 3.072MHz$. Typical values are at $T_A = +25^\circ C$)

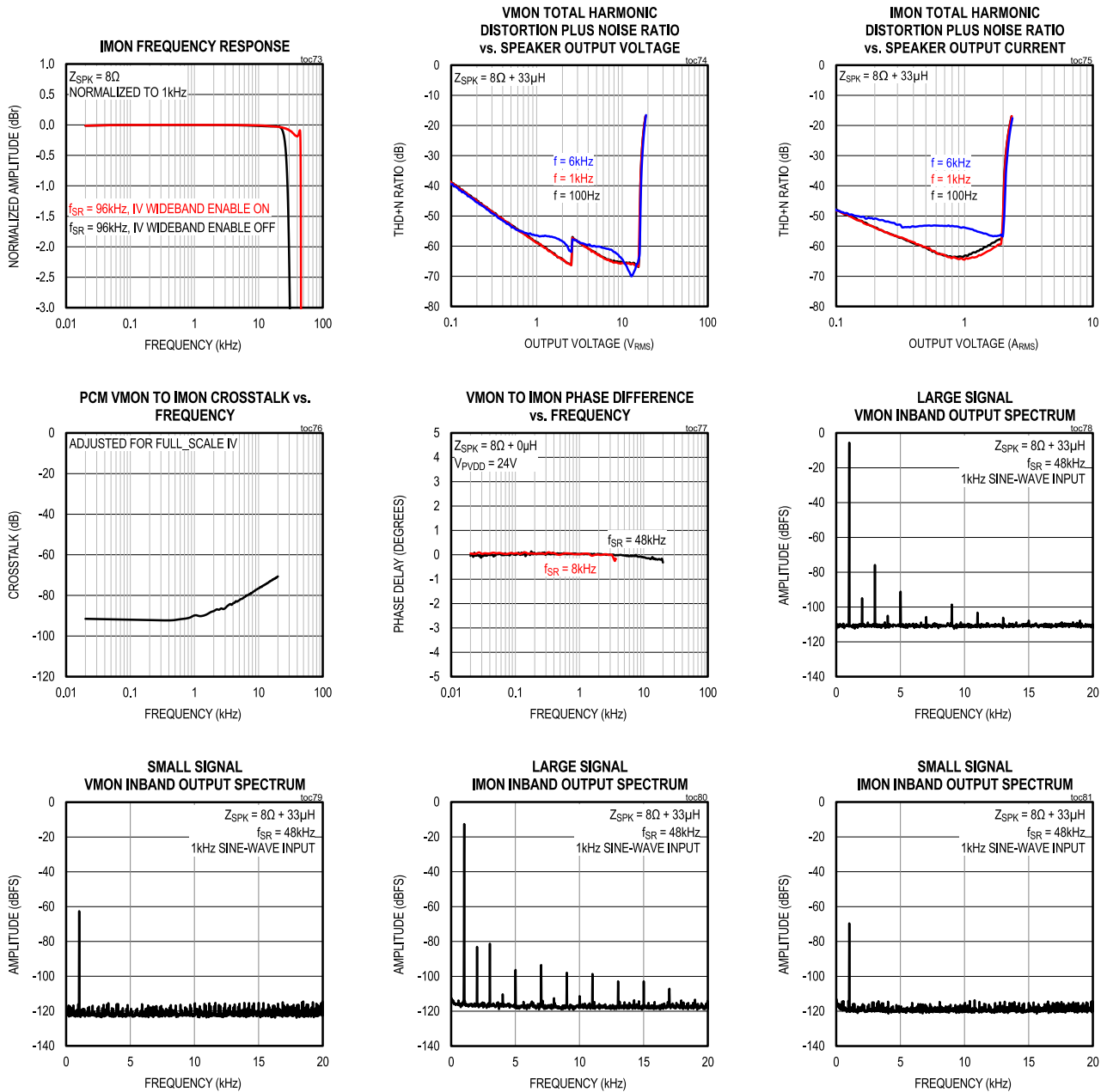

Typical Operating Characteristics (continued)

($V_{VBAT} = 5.0V$, $V_{DVDD} = 1.8V$, $V_{AVDD} = 1.8V$, $V_{GND} = 0V$, $V_{PGND} = 0V$, $V_{PVDD} = 24V$, $C_{VBAT} = 10\mu F + 0.1\mu F$, $C_{PVDD} = 0.1\mu F + 10\mu F + 220\mu F$, $C_{DVDD} = 1\mu F$, $C_{AVDD} = 1\mu F$, $C_{VBOOT_P} = 0.1\mu F$, $C_{VBOOT_N} = 0.1\mu F$, $A_V = 24dB$, $Z_{SPK} = \infty$ between OUTP and OUTN, AC Measurement Bandwidth = 20Hz to 20kHz, $f_S = 48kHz$, 24-bit data, $f_{CLK} = 3.072MHz$. Typical values are at $T_A = +25^\circ C$)

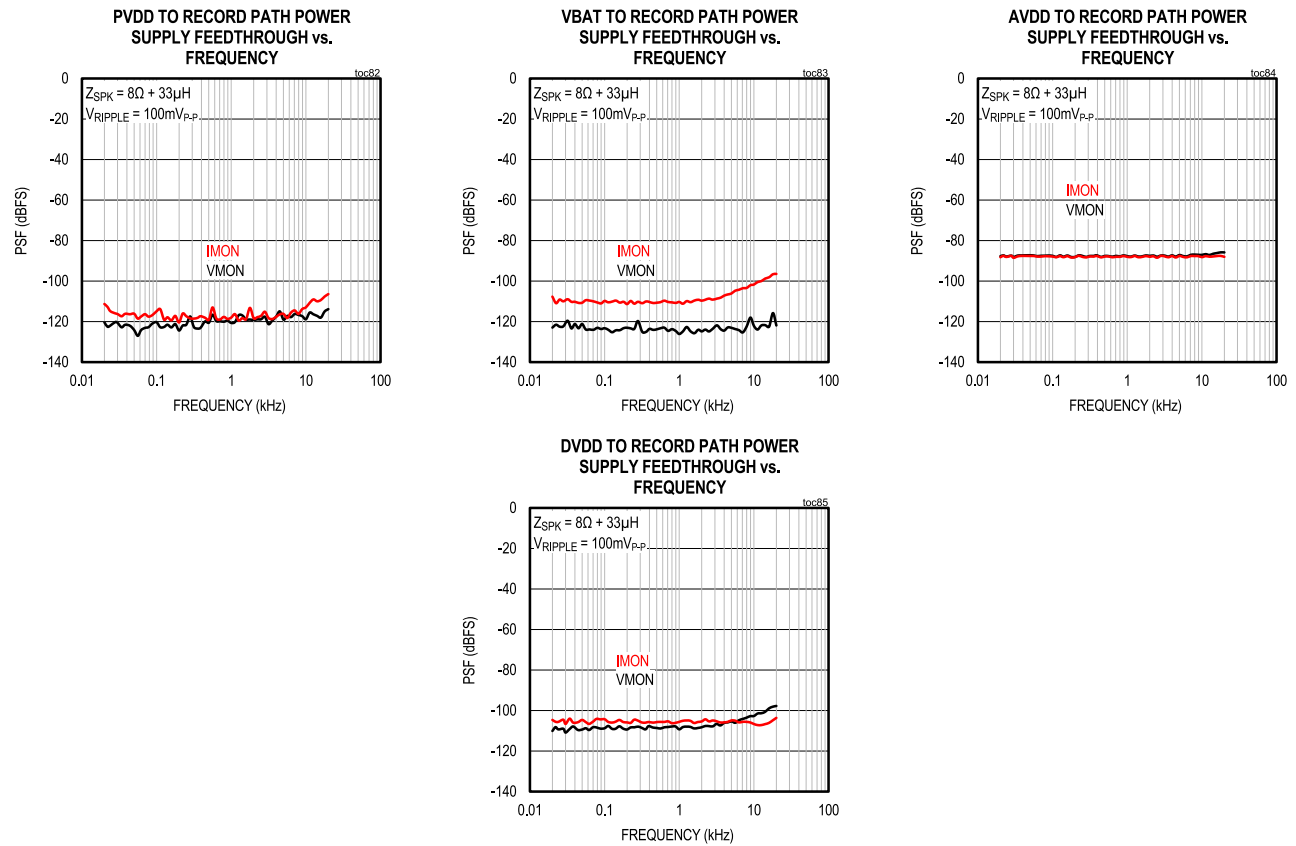

Pin Configuration

35 WLP

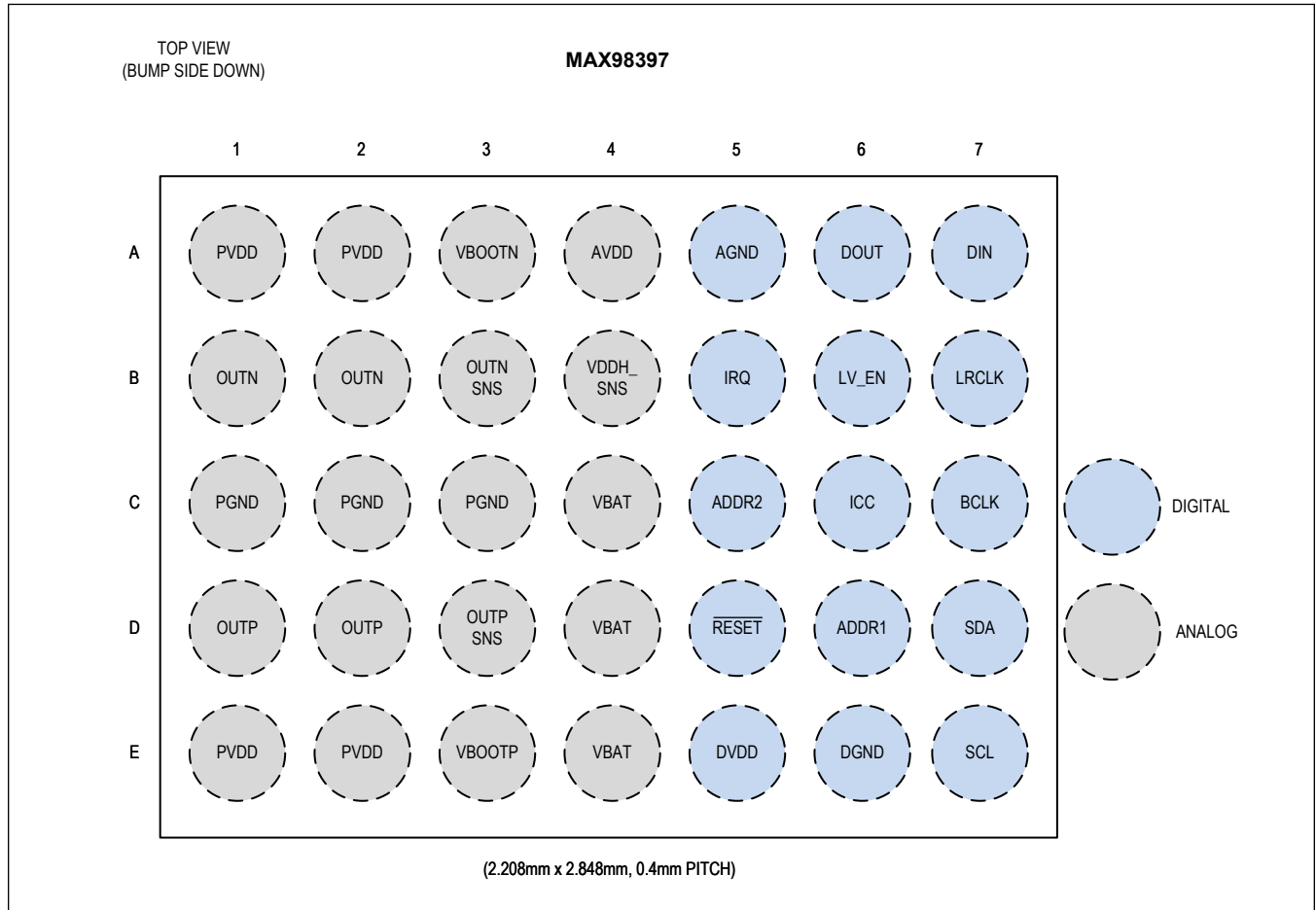

Pin Description

PIN	NAME	FUNCTION	REF SUPPLY	TYPE
E5	DVDD	Digital Core and Digital I/O Power Supply. Bypass to DGND with a 1µF capacitor.	—	Supply
E6	DGND	Digital Ground	—	Supply
A1, A2, E1, E2	PVDD	Speaker Amplifier Power Supply. Bypass each bump to PGND with a 0.1µF and 10µF capacitor placed as close as possible. Bypass the supply bus to PGND with a single 220µF bulk capacitor per device.	—	Supply
C1, C2, C3	PGND	Speaker Amplifier Ground	—	Supply
C4, D4, E4	VBAT	Battery Power Supply. Bypass to PGND with a 0.1µF and 10µF capacitor placed as close as possible.	—	Supply
A4	AVDD	Analog Power Supply. Bypass to AGND with a 1µF capacitor placed as close as possible.	—	Supply

Pin Description (continued)

PIN	NAME	FUNCTION	REF SUPPLY	TYPE
A5	AGND	Analog Ground. Connect to the common ground plane of the application.	—	Supply
D5	$\overline{\text{RESET}}$	Hardware Enable (Active-Low). Resets all digital portions of the device and all registers to default power-on reset (POR) settings.	DVDD	Digital Input
E3	VBOOTP	Bootstrap for High-Side Gate Drive. Connect 0.1 μ F capacitor between BOOTP and OUTP.	PVDD	—
A3	VBOOTN	Bootstrap for High-Side Gate Drive. Connect 0.1 μ F capacitor between BOOTN and OUTN.	PVDD	—
D1, D2	OUTP	Positive Speaker Amplifier Output	PVDD	Analog Output
D3	OUTPSNS	Speaker Amplifier Feedback Positive Input. Connect as close as possible to the positive terminal of the loudspeaker. This pin must form a complete loop with OUTP.	PVDD	Analog Output
B1, B2	OUTN	Negative Speaker Amplifier Output	PVDD	Analog Output
B3	OUTNSNS	Speaker Amplifier Feedback Negative Input. Connect as close as possible to the negative terminal of the loudspeaker. This pin must form a complete loop with OUTN.	PVDD	Analog Output
E7	SCL	I ² C-Compatible Serial-Clock. Connect a 1.5k Ω pullup resistor to DVDD for full logic-level swing.	DVDD	Digital I/O (Open-Drain)
D7	SDA	I ² C-Compatible Serial Data. Connect a 1.5k Ω pullup resistor to DVDD for full logic-level swing.	DVDD	Digital I/O (Open-Drain)
D6	ADDR1	I ² C Address Select Input 1. See the I²C Serial Interface section for additional information.	DVDD	Digital Input
C5	ADDR2	I ² C Address Select Input 2. See the I²C Serial Interface section for additional information.	DVDD	Digital Input
B5	IRQ	Hardware Interrupt Output. Interrupt polarity and pin-drive mode are configurable. Connect a 10k Ω pullup resistor to DVDD for full logic-level swing in open-drain mode.	DVDD	Digital Output
C7	BCLK	PCM Interface BCLK Input. Internally pulled down to DGND through R _{PD} .	DVDD	Digital Input
B7	LRCLK	PCM Interface Frame Clock Input/Output. LRCLK frequency matches the PCM interface sample rate. Internally pulled down to DGND through R _{PD} .	DVDD	Digital Input
A7	DIN	PCM Interface Data Input. Internally pulled down to DGND through R _{PD} .	DVDD	Digital Input
A6	DOUT	PCM Interface Data Output	DVDD	Digital Output
B6	LV_EN	Low Voltage Enable Output pin signals an external boost the active power supply used by the amplifier output stage. The pin is asserted when the amplifier uses VBAT as the supply for the output stage.	DVDD	Digital Output (Open-Drain)
C6	ICC	Interchip Communication Data Bus. Optionally allows multiple devices to be grouped up to communicate with each other. Internally pulled down to DGND through R _{PD} .	DVDD	Digital I/O
B4	VDDH_SNS	External Supply Remote Sense Input Pin	—	Analog Input

Detailed Description

Device State Control

The device has three distinct power states: the hardware-shutdown state, the software-shutdown state, and the active state. When transitioning between states, the device always moves from the hardware-shutdown state to the software-shutdown state to the active state (or the reverse) based on the state transition requirements. Normal transitions between the software-shutdown state and active state are reversible without waiting for an in-progress transition to be completed. State transitions due to fault conditions, supply removal, and reset conditions are not reversible and are always completed (once initiated) to protect the device.

Hardware-Shutdown State

When the device is first powered up or after a hardware reset event, the device always initializes into the hardware-shutdown state. In hardware shutdown, the device is configured to its lowest power state. Upon entering hardware shutdown, the device is globally placed into a reset condition. As a result, the I²C control interface is disabled, and all device registers are returned to their PoR states. When exiting the hardware shutdown, the device initializes and then transitions into the software-shutdown state. During this transition (as part of initialization), the OTP register trim settings are loaded. If the OTP load routine fails to complete successfully, an [OTP_FAIL](#) interrupt is generated once the device reaches the software-shutdown state.

When the hardware reset input ($\overline{\text{RESET}}$) is asserted low, the device enters (or remains in) hardware shutdown. The device is also placed into hardware shutdown anytime the DVDD supply drops below its POK threshold. The device only exits hardware shutdown when the PVDD supply and DVDD supply are above their UVLO thresholds, and the hardware reset input ($\overline{\text{RESET}}$) is asserted high. Once all of these conditions are met, the device automatically exits hardware shutdown and transitions into software shutdown.

Software-Shutdown State

The device enters the software-shutdown state after it transitions out of the hardware-shutdown state and when exiting the active state. In the software-shutdown state, all blocks are automatically disabled except for the I²C control interface. In the software-shutdown state, all device registers can be programmed without restriction, and all programmed register states are retained.

The global enable bit ([EN](#)) is used to transition the device into and out of software shutdown. When global enable ([EN](#)) is set high, the device transitions to the active state and a power-up done ([PWRUP_DONE](#)) interrupt is generated. When the device is in the active state and global enable ([EN](#)) is set low, the device transitions to the software-shutdown state and a power-down done ([PWRDN_DONE](#)) interrupt is generated. Additionally, the device is reset and enters software shutdown anytime the global reset bit ([RST](#)) is written with a 1.

By default, the device supply configuration is AVDD, PVDD, and VBAT pins being supplied with voltages, and in this scenario, regardless of the state of the global enable bit, the device cannot transition from the software-shutdown state to the active state until AVDD, PVDD, and VBAT are all above their UVLO thresholds. If DVDD, PVDD, or VBAT supplies drop below their UVLO levels, or if AVDD supply drops below its POK threshold while the device is in the active state, the device is forced back into the software-shutdown state. The AVDD and DVDD supplies drop below their UVLO thresholds while the device is in the active state, and an appropriate UVLO fault interrupt ([AVDD_UVLO](#) or [DVDD_UVLO](#) respectively) is generated.

While in the software-shutdown state, the AVDD, PVDD, and VBAT supplies can be powered down safely.

Recovery from Software Shutdown due to Supply Faults

The device provides two forms of fault recovery if either VBAT or PVDD drop below their UVLO thresholds while the device is in its active state. Based on the setting of the [VBAT_AUTORESTART_EN](#) and [PVDD_AUTORESTART_EN](#) bits, the individual supply fault recovery is either in manual mode or auto-restart mode.

If the bit is set low, then the supply UVLO fault recovery is in manual mode. In manual mode, when the supply drops below its UVLO threshold the device transitions into the software shutdown state (sets [EN](#) = 0) and generates the appropriate UVLO fault shutdown interrupt ([VBAT_UVLO_SHDN](#) or [PVDD_UVLO_SHDN](#) respectively). Even once the supply recovers (voltage levels exceed the UVLO thresholds), the device remains in the software shutdown state until

the global enable bit (*EN*) is set high by the host software and the AVDD supply is above its UVLO threshold.

If the bit is instead set high, then the supply UVLO fault recovery is in auto-restart mode. In auto-restart mode, when the supply drops below its UVLO threshold, the device is internally forced into software shutdown (*EN* state is preserved and remains high) and generates the appropriate UVLO fault shutdown interrupt (*VBAT UVLO SHDN ** or *PVDD UVLO SHDN ** respectively). Once the supply recovers (voltage levels exceed the UVLO thresholds), the device is no longer held in software shutdown and (if all other conditions are met) automatically restarts back into the active state. These recovery modes do not apply when the AVDD or DVDD supplies cause a UVLO fault while the device is in the active state. If DVDD drops below its POK thresholds, the device is reset and placed into hardware shutdown.

Active State

The device always enters the active state through a transition from the software-shutdown state. In the active state, all enabled device blocks are active and speaker amplifier playback is possible. In the active state, only dynamic register settings (or those restricted to disabled blocks) can be programmed safely.

The only non-fault state transitions to or from the active state are those initiated through the global enable bit (*EN*). All other transitions to or from the active state are the result of fault events and may result in audible glitches if they occur during active playback.

Device Sequencing

[Table 1](#) and [Table 2](#) show the recommended typical device power-up and power-down sequences.

Table 1. Typical Power-Up Sequence

STEP	ACTION	DETAILED DESCRIPTION
1	Power-Up Core Supplies	Power the PVDD, VBAT, AVDD, and DVDD supplies above their UVLO thresholds. For proper operation, $V_{PVDD} > V_{VBAT} - 0.3V$.
2	Exit Hardware-Shutdown State	Assert the hardware reset input (\overline{RESET}) to a logic high level. If \overline{RESET} is tied to the DVDD supply, this step is combined with step 1.
3	Enter Software-Shutdown State	The device finishes the transition and enters the software-shutdown state after the release from reset time (t_{I2C_READY}) elapses.
4	Program the Device Registers/Enable the External Clocks	The I ² C interface is active, and all registers can be freely configured. Start both external clocks before exiting the software shutdown state.
5	Exit Software-Shutdown State	If volume ramping is disabled, the input audio data should be silent. Set the global enable to a logic high ($EN = 1$).
6	Enter the Active State	The device enters the active state after the turn-on time (t_{ON}) elapses.
7	Active State/Audio Playback	Dynamic bits (and those restricted to disabled blocks) can be programmed. The device is capable of audio playback in the active state.

Table 2. Typical Power-Down Sequence

STEP	ACTION	DETAILED DESCRIPTION
1	Exit the Active State	If volume ramping is disabled, the input audio data should be silent. Set the global enable bit to a logic low ($EN = 0$)
2	Enter Software-Shutdown State	The device enters a software-shutdown state after the turn-off time (t_{OFF}) elapses.
3	Reprogram Device Registers/Disable the External Clocks	The device is fully programmable and can idle in the software shutdown state. The external clocks and the AVDD, PVDD, VBAT supplies can be disabled. To return to the active state, resume the power-up sequence from step 4.
4	Enter Hardware-Shutdown State	For full-hardware shutdown, disable the external clocks first. Assert the reset input (\overline{RESET}) to ground or power-down DVDD.

Power-Supply Sequencing

When powering-up the device, it is recommended that the Abs Max conditions for each pin are followed for device power-supply sequencing. If PVDD to VBAT absolute maximum setting cannot be followed during power-up, it is recommended that RESET be the last signal that is asserted in the system.

PCM Interface

The flexible PCM peripheral interface supports common audio playback sample rates from 16kHz to 192kHz and I/V sense ADC sample rates from 8kHz to 192kHz. The PCM interface also supports standard I²S, left-justified, and TDM data formats. The PCM interface is disabled and powered down when both the PCM data input (DIN) and PCM data output (DOUT) are disabled.

PCM Clock Configuration

The PCM peripheral interface requires the host to supply both BCLK and LRCLK. To configure the PCM interface clock inputs, the host must program both the device interface sample rate ([PCM_SR](#)) and the BCLK to LRCLK ([PCM_BSEL](#)) ratio. The PCM interface sample rate must be configured to match the frequency of the frame clock (LRCLK) using the [PCM_SR](#) registers. The speaker path sample rate is also set by the [PCM_SR](#) setting. However, the I/V sense ADC path sample rate ([IVADC_SR](#)) can be set to the same rate or a lower rate than the speaker path sample rate ([PCM_SR](#)) according to the restrictions in [Table 3](#). When the I/V sense ADC path is set to a lower rate than the speaker amplifier path, the output data contains repeated samples.

Table 3. Sample Rate Selection For I/V Sense

N/A = Not Available N/S = Not Supported	I/V SENSE ADC SAMPLE RATE (kHz)													
	192	176.4	96	88.2	48	44.1	32	24	22.05	16	12	11.025	8	
PCM Interface and Speaker Path Sample Rate (kHz)	192	1	N/S	2	N/S	4	N/S	6	8	N/S	12	16	N/S	24
	176.4	N/A	1	N/S	2	N/S	4	N/S	N/S	8	N/S	N/S	16	N/S
	96	N/A	N/A	1	N/S	2	N/S	3	4	N/S	6	8	N/S	12
	88.2	N/A	N/A	N/A	1	N/S	2	N/S	N/S	4	N/S	N/S	8	N/S
	48	N/A	N/A	N/A	N/A	1	N/S	N/S	2	N/S	3	4	N/S	6
	44.1	N/A	N/A	N/A	N/A	N/A	1	N/S	N/S	2	N/S	N/S	4	N/S
	32	N/A	N/A	N/A	N/A	N/A	N/A	1	N/S	N/S	2	N/S	N/S	4
	24	N/A	N/A	N/A	N/A	N/A	N/A	N/A	1	N/S	N/S	2	N/S	3
	22.05	N/A	N/A	N/A	N/A	N/A	N/A	N/A	N/A	1	N/S	N/S	2	N/S
	16	N/A	N/A	N/A	N/A	N/A	N/A	N/A	N/A	N/A	1	N/S	N/S	2

The device supports a range of BCLK to LRCLK clock ratios ([PCM_BSEL](#)) ranging from 32 to 512. However, based on the selected PCM interface sample rate (LRCLK frequency), the configured clock ratio cannot result in a BCLK frequency that exceeds 24.576MHz.

PCM Data Format Configuration

The device supports the standard I²S, left-justified, and TDM data formats, and the operating mode is configured using the [PCM_FORMAT](#) bit field.

I²S/Left-Justified Mode

I²S and left-justified formats support two channels that can be 16-, 24-, or 32-bits in length. The BCLK to LRCLK ratio ([PCM_BSEL](#)) must be configured to be twice the desired channel length. The audio data word size is configurable to 16-, 24-, or 32-bits in length ([PCM_CHANSZ](#)) but must be programmed to be less than or equal to the channel length. If the resulting channel length exceeds the configured data word size, then the data input LSBs are truncated and the data output LSBs are padded with either zero or Hi-Z data based on the [PCM_TX_EXTRA_HIZ](#) register bit setting.

Table 4. Supported I²S/Left-Justified Mode Configurations

CHANNELS	CHANNEL LENGTH	SUPPORTED DATA WORD SIZES (<i>PCM_CHANSZ</i>)	BCLK TO LRCLK RATIO (<i>PCM_BSEL</i>)
2	16	16	32
	24	16, 24	48
	32	16, 24, 32	64

With the default PCM settings, falling LRCLK indicates the start of a new frame and the left channel data (Channel 0) while rising LRCLK indicates the right channel data (Channel 1). In I²S mode, the MSB of the audio word is latched on the second active BCLK edge after an LRCLK transition. In left-justified mode, the MSB of the audio word is latched on the first active BCLK edge after an LRCLK transition.

The *PCM_BCLKEDGE* register bit selects either the rising or falling edge of BCLK as the active edge that is used for data capture (DIN) and data output (DOUT). The *PCM_CHANSEL* bit configures which LRCLK edge indicates the start of a new frame (Channel 0), and LRCLK transitions always align with the inactive BCLK edge. The data output is valid on the same active BCLK edge as the data input. The data output also transitions on the same edge as the data input.

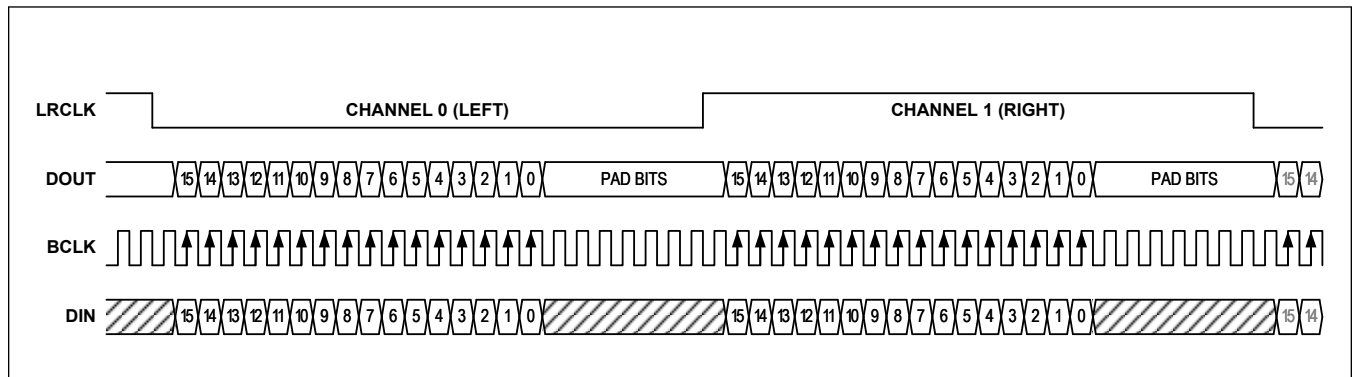

Figure 1. Standard I²S Mode

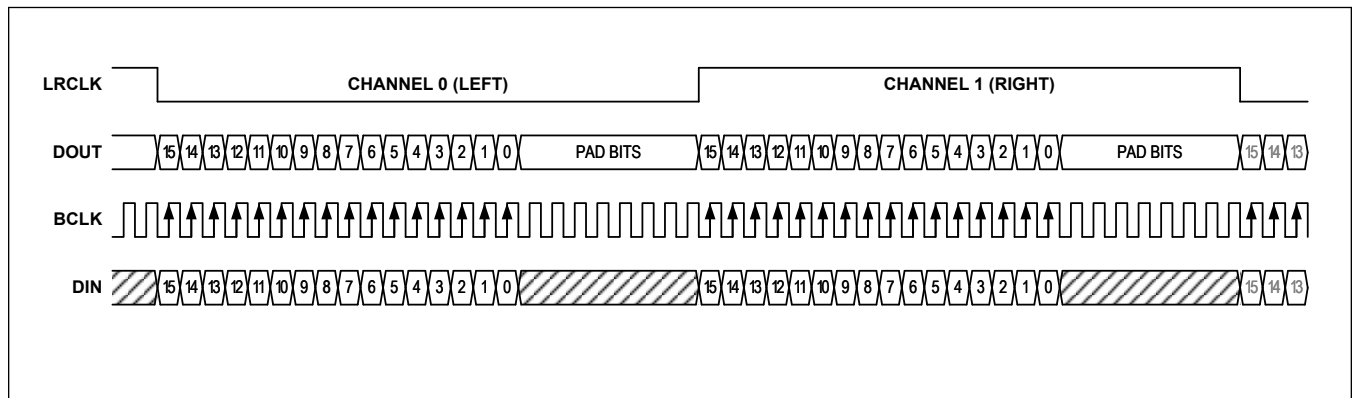

Figure 2. Left-Justified Mode

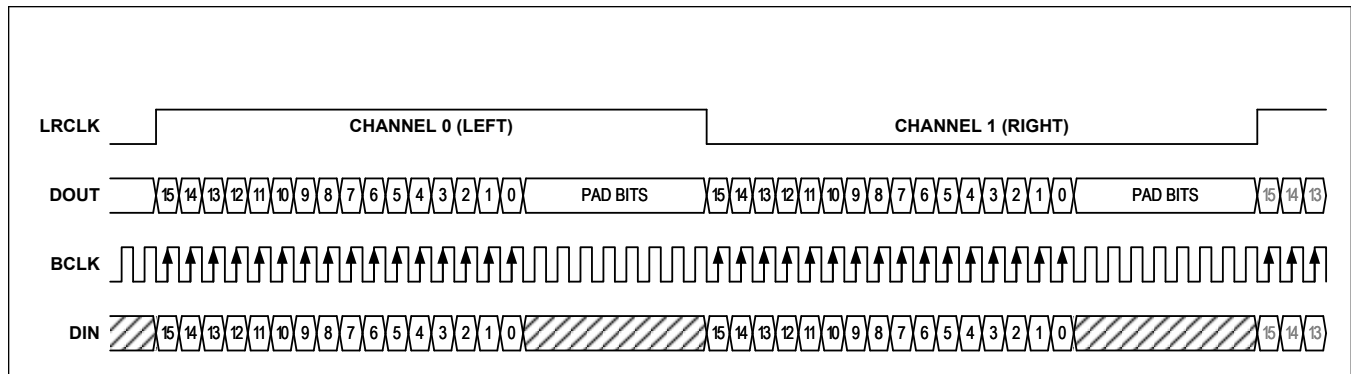

Figure 3. Left-Justified Mode (LRCLK Inverted)

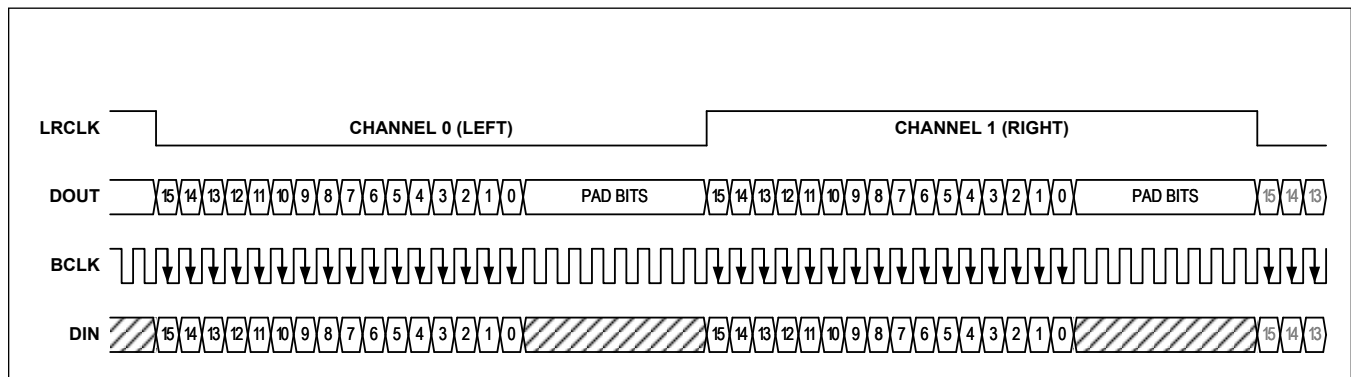

Figure 4. Left-Justified Mode (BCLK Inverted)

TDM Modes

The provided TDM modes support timing for up to 16 digital audio input channels (from DIN) each containing 16-, 24-, or 32-bits of data. The digital audio output (to DOUT) is structured into 8-bit slots, and the timing can support up to a maximum of 128 data output slots. The number of TDM input channels and output slots is determined by both the selected BCLK to LRCLK ratio ([PCM_BSEL](#)) and the selected data word and channel length ([PCM_CHANSZ](#)).

For a given valid configuration, the number of available data input channels per frame is calculated as follows:

$$\text{Number of Available Data Input Channels} = \text{BCLK to LRCLK Ratio} / \text{Channel Length}$$

For a given valid configuration, the number of available 8-bit data output slots per frame is calculated as follows:

$$\text{Number of Available Data Output Slots} = \text{BCLK to LRCLK Ratio} / 8$$

[Table 5](#) shows the supported TDM mode configurations for each combination of input data channels and output data slots. In some configurations, the maximum PCM interface and speaker amplifier playback sample rate is limited to less than 96kHz to avoid violating the BCLK frequency limit of 24.576MHz.

Table 5. Supported TDM Mode Configurations

INPUT DATA CHANNELS	OUTPUT DATA SLOTS	DATA WORD SIZES (PCM_CHANSZ)	BCLK TO LRCLK RATIO (PCM_BSEL)	MAXIMUM SPEAKER PLAYBACK SAMPLE RATE (f_{LRCLK})
2	4	16	32	192kHz
	6	24	48	
	8	32	64	

Table 5. Supported TDM Mode Configurations (continued)

3	15	32	125	96kHz
4	8	16	64	
	12	24	96	
	16	32	128	
5	15	24	125	
7	15	16	125	
2	4	16	32	
	6	24	48	
	8	32	64	
3	15	32	125	
4	8	16	64	
	12	24	96	
	16	32	128	
5	15	24	125	
7	15	16	125	
	31	32	250	
8	16	16	128	
	24	24	192	
	32	32	256	
10	31	24	250	
15	31	16	250	
16	32	16	256	
7	31	32	250	48kHz
10	31	24	250	
10	40	32	320	
15	31	16	250	
16	48	24	384	
	64	32	512	

With the default PCM interface settings, in TDM mode a rising frame clock (LRCLK) edge acts as the frame sync pulse and indicates the start of a new frame. The frame sync pulse width must be equal to at least one bit clock period however the falling edge can occur at any time as long as it does not violate the setup time of the next frame sync pulse rising edge. The [PCM_CHANSEL](#) bit can be used to invert the LRCLK edges (sync pulse) used to start a TDM frame.

In TDM mode, the MSB of the first audio word can be latched on the first (TDM Mode 0), second (TDM Mode 1), or third (TDM Mode 2) active BCLK edge after the sync pulse and is programmed by the [PCM_FORMAT](#) bits. Additionally, the [PCM_BCLKEDGE](#) register bit allows for the programmability of the BCLK edge that is used for data capture and data output. The data output is valid on the same active BCLK edge as the data input. The data output also transitions on the same edge as data input.

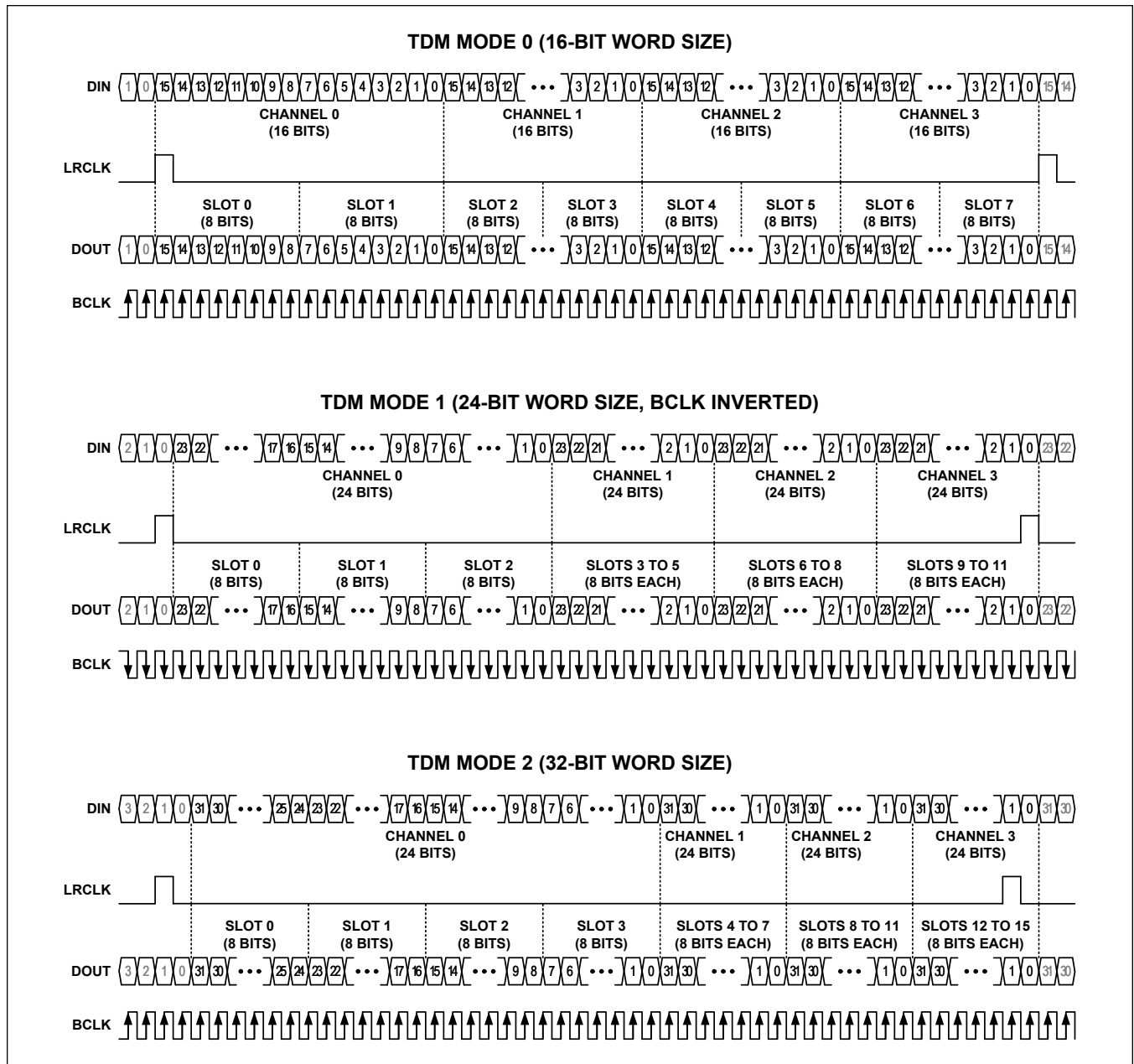

Figure 5. TDM Modes

PCM Data Path Configuration

The PCM interface data input (DIN) receives the source data for the speaker amplifier path, source data for the speaker audio processing bypass path, and the data output (DOUT) transmits the data from the I/V sense ADC path. In addition, the PCM data output can also transmit internal diagnostic data such as the speaker DSP monitor path, supply measurement ADC results, device status reporting, and the DHT attenuation level.

PCM Data Input

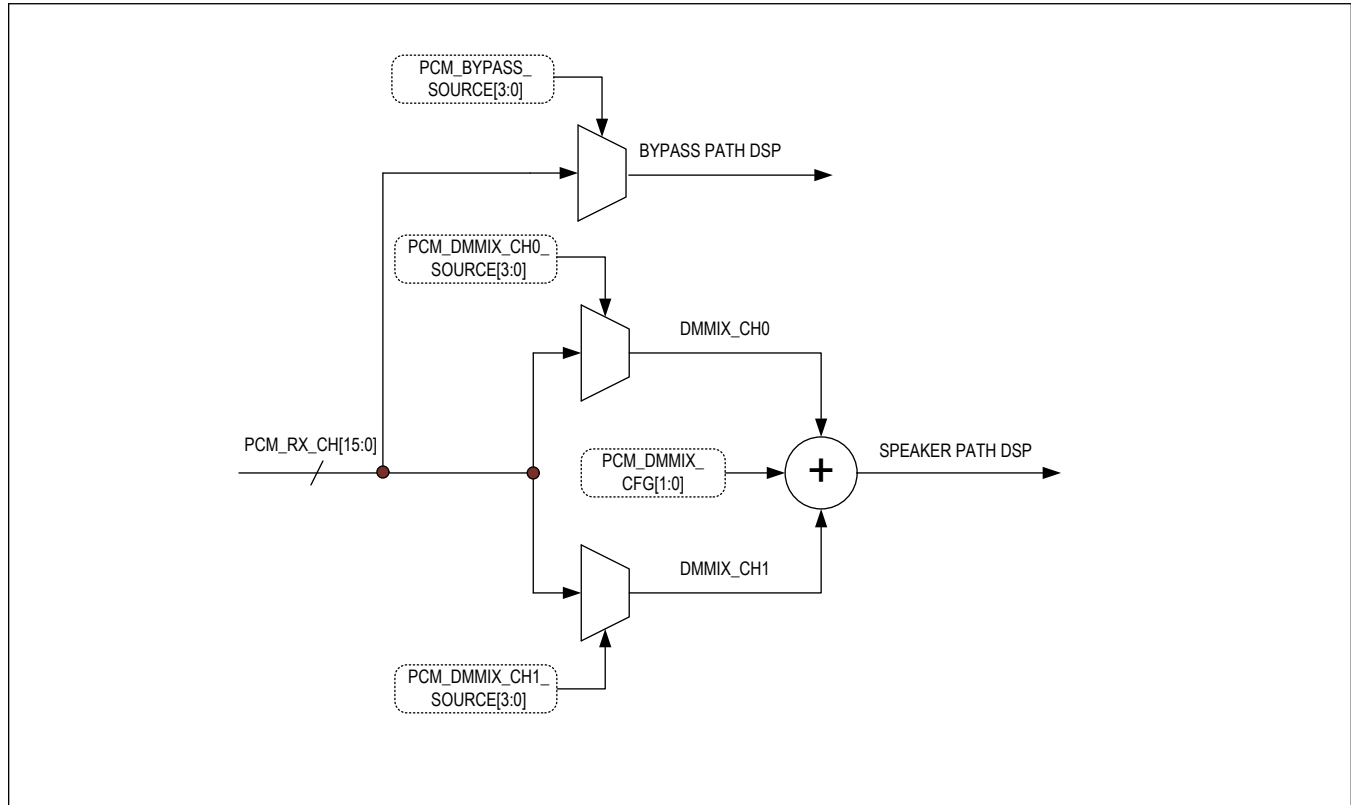

Figure 6. PCM Data Input

The PCM playback path is enabled with the [PCM_RX_EN](#) bit and can accept data from any valid input data channel. The device provides an input digital mono mixer that can route a single channel or can mix two PCM input channels to create a mono input to the speaker playback path. The [PCM_DMMIX_CFG](#) bit is used to configure the mixer, while the [PCM_DMMIX_CH0_SOURCE](#) and [PCM_DMMIX_CH1_SOURCE](#) bits select which of the 16 PCM input channels are used as the input to the mono mixer. In I²S and left-justified modes, only 2 input data channels are available while in TDM mode up to 16 channels of input data may be available. If the PCM playback path is disabled ([PCM_RX_EN](#) = 0), a zero code value is driven into the speaker amplifier path.

The device also supports an audio processing bypass path from the PCM input to the speaker amplifier output that bypasses the audio processing blocks like the volume control, DHT, BPE, and thermal foldback circuits. The audio processing bypass path is enabled by setting the [PCM_BYP_EN](#) bit field to 1. The PCM data input for the audio processing bypass path is selected with the [PCM_BYPASS_SOURCE](#) bit field. If the PCM audio processing bypass path is disabled ([PCM_BYP_EN](#) = 0), a zero code value is driven into the audio processing bypass path.

PCM Data Output

The PCM interface data output (DOUT) is enabled by the [PCM_TX_EN](#) bit field and can transmit any output data type onto any valid output channel or slot. In I²S and left-justified mode, only 2 data output channels are available in each output transmit frame (channels 0 and 1). In TDM mode, each output transmit frame can contain up to 64 sequential 8-bit data output slots, each of which is numbered from 0 up to a maximum of 63.

The PCM data output can transmit several different output data types. In I²S and left-justified modes, only the speaker amplifier output voltage sense, output current sense, ICC data, and DSP monitor output data types are available for data output transmission. If the word size of the data output type is longer than the output channel data word ([PCM_CHANSZ](#)), the lowest trailing bits are truncated. In I²S mode, both ICC data and IV sense data can be transmitted only when the

channel data word ([PCM_CHANSZ](#)) is 32 bits. In this mode the IV sense data and the ICC data are interleaved. See the [Data Output Channel-Interleaved I/V Sense Data](#) section for more details.

In TDM mode, all output data types are available and are individually assigned to data output slots. The output data types vary in word size from 3-bits to 32-bits, and as a result, TDM mode requires from 1 to 4 data output slots to transmit. [Table 6](#) shows the supported output data types and the parameters of each data type.

Table 6. Supported PCM Data Output Types

OUTPUT DATA TYPE	SYMBOL	DATA WORD SIZE (BITS)	NUMBER OF TDM SLOTS	ENABLE/SLOT ASSIGNMENT
Speaker Amplifier Output Voltage Sense	VMON	16	2	PCM_VMON_EN/ PCM_VMON_SLOT
Speaker Amplifier Output Current Sense	IMON	16	2	PCM_IMON_EN/ PCM_IMON_SLOT
Speaker Amplifier DSP Monitor	DSPMON	32	4	PCM_DSPMONITOR_EN/ PCM_DSP_MONITOR_SLOT
Applied DHT Attenuation	DHT_ATN	16	2	PCM_DHT_ATN_EN/ PCM_DHT_ATN_SLOT
Supply1 Voltage (V _{VBAT} OR V _{PVDD} OR V _{VDDH})	VSUPPLY1	16	2	PCM_SUPPLY1_EN/ PCM_SUPPLY1_SLOT/ SUPPLY_SELECT
Supply2 Voltage (V _{VBAT} OR V _{PVDD} OR V _{VDDH})	VSUPPLY2	16	2	PCM_SUPPLY2_EN/ PCM_SUPPLY2_SLOT/ SUPPLY_SELECT
BPE Level	BPELVL	3	1	PCM_BPE_EN/ PCM_BPE_SLOT
ICC Data	ICCDATA	23	4	ICC_OVER_DOUT_EN/ PCM_ICC_SLOT
Device Status Flags	FLAG	14	2	PCM_STATUS_EN/ PCM_STATUS_SLOT
Temperature	TEMP	9	2	PCM_THERM_EN/ PCM_THERM_SLOT

An individual enable and slot assignment bit field is provided for each output data type. In I²S and left-justified modes, use output slot 00/01 ([PCM_TX_Control X](#) = 0x0) to assign data to channel 0 and output slot 01/02 ([PCM_TX_Control X](#) = 0x1) to assign data to channel 1. In TDM mode, for data output types requiring more than 1 slot to transmit, the slot assignment selects the slot where the output data type transmit begins (so for example a 2-slot data type assigned to slot 6 would occupy slots 6 and 7).

In TDM mode, each data type can be assigned to any valid data output slot (or series of slots) with some restrictions. First, it is invalid for data types to be assigned such that the data word extends beyond the end of the data output frame. For example, data types that require 2 slots to transmit cannot be assigned to the last slot of the frame. Next, it is also invalid to assign a data output type to any slot that overlaps with the slot assignment of another data type (this also applies to channels in I²S and left-justified modes). Finally, it is invalid to assign a data type to any slots that do not exist in the frame structure of the current PCM interface configuration.

Any data output (DOUT) slots that exist in the current frame structure but have no output data type assigned to them are either Hi-Z or driven with a 0 code (as set by the [PCM_TX_SLOT_HIZ](#) bit field). Likewise, if a data output type is disabled, then the assigned data output slot(s) are also either Hi-Z or driven with a 0 code (as set by the [PCM_TX_SLOT_HIZ](#) bit field).

Data Output Channel-Interleaved I/V Sense Data

In I²S and left-justified use cases, the PCM interface limits the number of available data output channels to 2 making it impossible to fit amplifier output current and voltage sense data from stereo devices on a single shared data

output (DOUT) line. For these cases, the data output can be configured to allow the current and voltage sense data types from a single device to share a single data output channel. To enable channel-interleaved mode, set the [PCM_TX_INTERLEAVE](#) bit high. Then, assign the current and voltage sense data types to the same valid data channel (using [PCM_VMON_SLOT](#) and [PCM_IMON_SLOT](#)).

In this configuration, the current and voltage sense data types are frame interleaved on the assigned data output channel. The current and voltage sense data words are both 16-bits in length, and as a result, if the channel length is longer than 16-bits, the trailing padding bits are set to either Hi-Z or 0 code depending on the state of the [PCM_TX_EXTRA_HIZ](#) bit field.

To identify the data type in channel-interleaved mode, the LSB of the 16-bit data word is dropped (truncated). The data word is then right-shifted by a single bit, and the now vacant MSB is replaced with either a 0 to indicate voltage sense data or a 1 to indicate current sense data. For phase alignment, the voltage sense data for a single sampling instant is always transmitted in the assigned channel on the first frame, followed by the current sense data on the second frame. The MSB value and the transmission order allow the host to identify and phase-align the output data across frames.

Since the I/V sense data is frame interleaved, the sample rate for the PCM interface must be greater than that of the I/V sense ADCs by an integer ratio of 2. [Figure 7](#) shows a basic case where the sample rate of the PCM interface is twice that of the I/V sense ADCs.

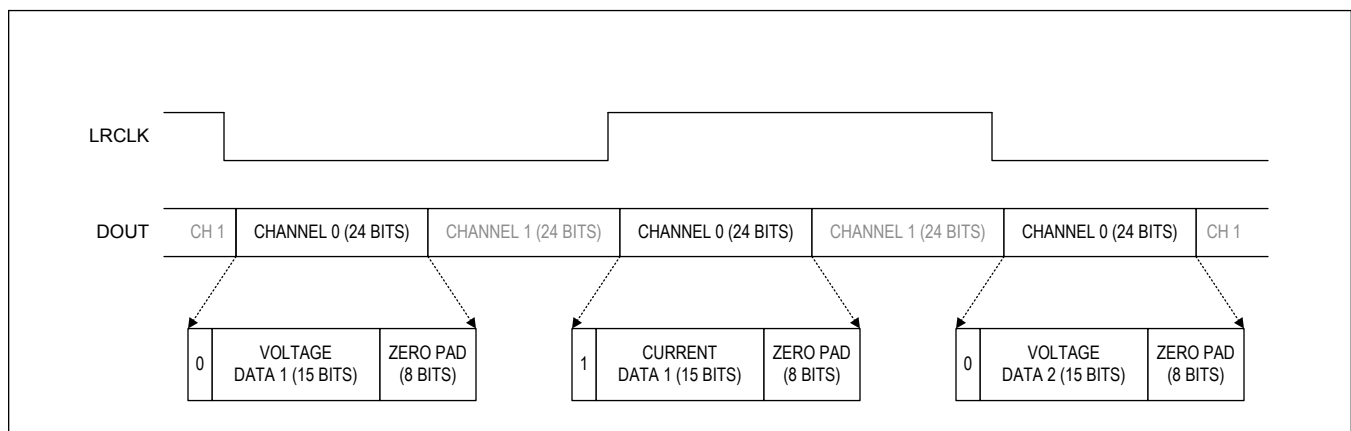

Figure 7. I²S Mode with Interleaved Voltage and Current Data, Channel Length = 24 Bits, Zero Padding

Data Output Status Bits

The following interrupt information is reported in the status slots:

- Bit 15: BPE level 0 begin
- Bit 14: BPE level change
- Bit 13: BPE active begin
- Bit 12: BPE active end
- Bit 11: Thermal warning 1 begin
- Bit 10: Thermal warning 1 end
- Bit 9: Thermal warning 2 begin
- Bit 8: Thermal warning 2 end
- Bit 7: Thermal foldback begin
- Bit 6: Thermal foldback end
- Bit 5: DHT active end
- Bit 4: DHT active begin
- Bit 3: Speaker overcurrent
- Bit 2: Power-up done
- Bit 1: 0
- Bit 0: 0

Each of the above corresponds to a raw interrupt and is 1 bit wide. When a raw interrupt has a rising edge, the

corresponding status bit goes high during the next LRCLK frame. The status bit goes low during the next LRCLK frame even if the raw interrupt has remained high.

Interrupts

The device supports individually enabled status interrupts for sending feedback to the host about events that have occurred on-chip. When enabled, interrupts are transmitted on the IRQ output.

Interrupt Bit Field Composition

Each interrupt source has five individual bit field components. The function of each component is detailed below and the corresponding bit fields for each source can be identified by the appended suffix (shown in parentheses).

Raw Status (RAW) Each interrupt source has a read-only bit to indicate the real-time raw status of the interrupt source. **State (STATE)** Each interrupt source has a read-only state bit that is set whenever a rising edge occurs on the associated raw status bit. The state bit is set regardless of the setting of the source enable bit. **Flag (FLAG)** Each interrupt source has a read-only flag bit. If the source enable bit is set, then the flag bit is set and an interrupt can be generated whenever the source state bit is set. **Enable (EN)** Each interrupt source has a dynamic read/write enable bit. When the enable bit is set, the associated flag bit is set and an interrupt can be generated whenever the source state bit is set. **Clear (CLR)** Each interrupt source has a dynamic write-only clear bit. Writing a 1 to a clear bit resets the associated state and flag bits to 0. Writing a 0 to a clear bit has no effect. In I²C control mode, the IRQ output is de-asserted if all flag bits are 0.

Interrupt Output Configuration

The device allows the user to configure the drive mode, drive strength, and polarity of the IRQ output. The [IRQ_MODE](#) bit controls the drive mode. If [IRQ_MODE](#) is 0, the pin is configured as an open-drained output and requires an external pullup resistor. If [IRQ_MODE](#) is 1, then IRQ is configured as a push-pull CMOS output.

Additionally, when IRQ is configured as a push-pull CMOS output, the drive strength control ([IRQ_DRV](#)) bits set the drive strength of the IRQ output. Four different CMOS drive strengths are available.

The [IRQ_POL](#) bit controls the polarity of the IRQ bus. Interrupt events (a flag bit is set high) assert the IRQ bus low if [IRQ_POL](#) = 0 and high if [IRQ_POL](#) = 1. The IRQ bus de-asserts if all flag bits are cleared (set low).

Interrupt Sources

Table 7. Interrupt Sources

INTERRUPT SOURCES	BIT FIELD	DESCRIPTION
Thermal Shutdown Begin Event	THERMSHDN_BGN *	Indicates when the thermal-shutdown threshold temperature has been exceeded.
Thermal Shutdown End Event	THERMSHDN_END *	Indicates that the die temperature was previously above the thermal-shutdown threshold and has now dropped below the threshold.
Thermal Warning 1 Begin Event	THERMWARN1_BGN *	Indicates when the thermal-warning1 threshold temperature has been exceeded.
Thermal Warning 1 End Event	THERMWARN1_END *	Indicates that the die temperature was previously above the thermal-warning1 threshold and has now dropped below the threshold.
Thermal Warning 2 Begin Event	THERMWARN2_BGN *	Indicates when the thermal-warning2 threshold temperature has been exceeded.
Thermal Warning 2 End Event	THERMWARN2_END *	Indicates that the die temperature was previously above the thermal-warning2 threshold and has now dropped below the threshold.

Table 7. Interrupt Sources (continued)

Thermal Foldback Begin Event	<u>THERMFB_BGN</u> *	Indicates die temperature is above the thermal-warning1 threshold and the device is attenuating the output.
Thermal Foldback End Event	<u>THERMFB_END</u> *	Indicates die temperature is below the thermal-warning1 threshold and the device has stopped attenuating the output.
BPE Level Change Event	<u>BPE_LEVEL</u> *	Indicates that the BPE has transitioned between thresholds.
BPE Active Begin Event	<u>BPE_ACTIVE_BGN</u> *	Indicates that the BPE is active.
BPE Active End Event	<u>BPE_ACTIVE_END</u> *	Indicates that the BPE is no longer active.
BPE Level 0 Begin Event	<u>BPE_L0</u> *	Indicates that the BPE has transitioned into L0.
OTP Load Fail Event	<u>OTP_FAIL</u> *	Indicates when the OTP load routine that runs when exiting hardware shutdown has failed to complete successfully. If the OTP load routine fails, the device is held in software shutdown.
Speaker Over Current Event	<u>SPK_OVC</u> *	Indicates that the speaker amplifier current limit has been exceeded.
Internal CLK Error	<u>INT_CLK_ERR</u> *	Indicates a clock stop error in the internal clocks of the device.
External CLK (BCLK/LRCLK) Error	<u>CLK_ERR</u> *	Indicates a frequency or framing error in the input BCLK or LRCLK.
External CLK (BCLK/LRCLK) Recover	<u>CLK_RECOVER</u> *	Indicates that the input BCLK or LRCLK has recovered after an error event.
Speaker Amplifier Monitor Error	<u>INT_SPKMON_ERR</u> *	Indicates an amplifier output stuck high or low error.
External Data (DIN) Error	<u>DMON_ERR</u> *	Indicates a data stuck or data magnitude error at the PCM data input (DIN).
Power-Up Done Event	<u>PWRUP_DONE</u> *	Indicates when the device has entered the active state, and the device is ready to play audio.
Power-Down Done Event	<u>PWRDN_DONE</u> *	Indicates when the device has entered the software-shutdown state.
PVDD UVLO Shutdown Event	<u>PVDD_UVLO_SHDN</u> *	Indicates that PVDD is below the minimum allowed voltage when the device is in active state.
VBAT UVLO Shutdown Event	<u>VBAT_UVLO_SHDN</u> *	Indicates that VBAT is below the minimum allowed voltage when the device is in active state.
DHT Active Begin Event	<u>DHT_ACTIVE_BGN</u> *	Indicates that the DHT circuit is active and is applying attenuation to the signal.
DHT Active End Event	<u>DHT_ACTIVE_END</u> *	Indicates that the DHT circuit has stopped applying attenuation to the signal.
Note: The bit fields are shown without the component suffixes. For example, <u>OTP_FAIL</u> * refers to <u>OTP_FAIL_RAW</u> , <u>OTP_FAIL_STATE</u> , <u>OTP_FAIL_FLAG</u> , <u>OTP_FAIL_EN</u> , and <u>OTP_FAIL_CLR</u> . All Interrupt sources have these 5 component bit fields.		

Speaker Path

The source input data to the speaker amplifier path is routed from either the PCM interface or the tone generator. The data is then routed through digital filters, signal processing, and volume/gain control blocks before reaching the Class-DG speaker amplifier.

Speaker Path Block Diagram

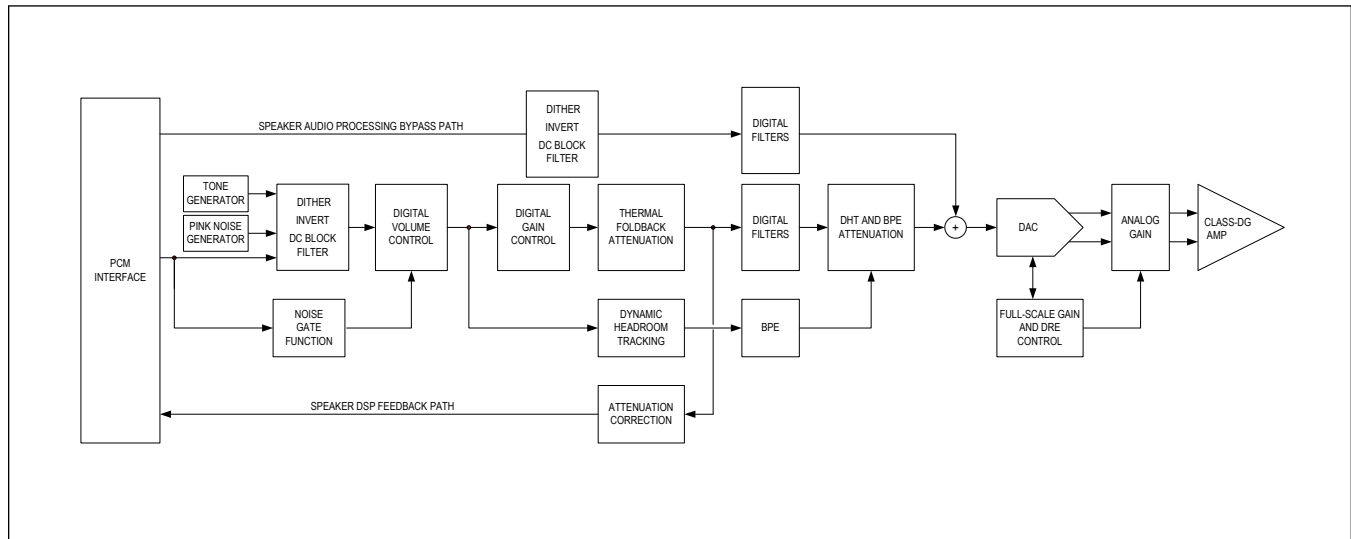

Figure 8. Speaker Signal Path Diagram

Speaker Playback Path

The source input data to the speaker amplifier path is routed from either the PCM interface or the tone generator. The data is then routed through digital filters, signal processing, and volume/gain control blocks before reaching the Class-DG speaker amplifier.

Speaker Path Noise Gate

The speaker path noise gate function is enabled when the device is in the active state and the noise gate enable ([NOISEGATE_EN](#)) is set to 1. The noise gate enable can be programmed dynamically. However, if the noise gate function is disabled ([NOISEGATE_EN](#) is set to 0) while the noise gate is active (speaker path actively muted), the noise gate function remains active until after it deactivates normally (unmutes the speaker path).

When the noise gate is enabled, the noise gate activates whenever the amplitude of the input audio data to the speaker path (from the PCM interface) is below the configured mute threshold ([NG_MUTE_THRESH](#)) for more than 1024 consecutive data samples. When the noise gate is active, the amplifier path is muted, the current and voltage sense ADC paths output zero code data, and the device idles in a reduced power state.

The noise gate deactivates immediately if the amplitude of a single sample from the input audio data exceeds the configured unmute threshold ([NG_UNMUTE_THRESH](#)). When the noise gate deactivates, the speaker path is unmuted and returns to normal operation before the input audio data (that triggered deactivation) reaches the speaker output. Once noise gate deactivation is completed, the current and voltage sense ADC paths resume operation and output data normally.

The noise gate mute and unmute threshold settings are selected in terms of the number of bits (starting from the LSB) that must be toggling (or active) for the input signal amplitude to exceed the thresholds. It is invalid to set the noise gate unmute threshold ([NG_UNMUTE_THRESH](#)) such that it is less than the configured mute threshold ([NG_MUTE_THRESH](#)). The location of the audio data LSB within the PCM input data channel is determined by the configured PCM data word size ([PCM_CHANSZ](#)). The supported combinations are shown in [Table 8](#).

Table 8. Noise Gate Threshold LSB Location by Input Data Configuration

INPUT DATA WORD SIZE (PCM_CHANSZ)	NOISE GATE FUNCTION LSB LOCATION
16	16
24	24
32	

It is not valid to enable the speaker path noise gate function when the tone generator is enabled or when the speaker idle mode is enabled.

Speaker Path Dither

The input data to the speaker path can optionally have dither (± 1 LSB peak-to-peak) applied if [SPK_DITH_EN](#) is set to 1. No dither is applied when [SPK_DITH_EN](#) is set to 0.

Speaker Path Data Inversion

The input data to the speaker path can optionally be inverted by setting the [SPK_INVERT](#) bit is set to 1.

Speaker Path DC Blocking Filter

A DC blocking filter can be enabled on the speaker path by setting the [SPK_DCBLK_EN](#) bit to 1.

Speaker Path Digital Volume Control

The device provides a dynamically programmable speaker path digital volume control. The digital volume control provides an attenuation range of 0dB to -90dB in 0.5dB steps that is configured with the [SPK_VOL](#) bit field. A digital mute is also provided and is enabled when [SPK_VOL](#) is set to 0xFF.

Digital volume ramping during speaker path start-up, speaker path shutdown, and digital mute ([SPK_VOL](#) = 0xFF) is disabled by default. However, both the volume ramp-up and ramp-down can be individually enabled with the [SPK_VOL_RMPUP_BYPASS](#) and [SPK_VOL_RMPDN_BYPASS](#) bit fields respectively. When volume ramp-up or ramp-down is enabled, the device turn-on and turn-off times are longer.

Speaker Path Digital Gain Control

The device provides a programmable speaker path digital gain control. The digital gain control provides a range of 0dB to +6dB in 0.5dB steps that is configured with the [SPK_GAIN](#) bit field. Unlike the digital volume control, the digital gain setting cannot be dynamically changed.

Speaker Path DSP Data Feedback Path

The speaker path DSP data can be routed from just before the DAC input back to the PCM interface, and can be assigned to any valid data output channel. The speaker path DSP data feedback path is enabled with the [SPK_FB_EN](#) bit.

Speaker-Safe Mode

The device provides a safe mode bit ([SPK_SAFE_EN](#)), which when set to 1, applies a -18dB attenuation to the input signal. By default, speaker safe mode is enabled to protect any speaker connected to the device on power-up. While speaker safe mode is enabled, the digital volume control ([SPK_VOL](#)) and speaker digital gain control ([SPK_GAIN](#)) settings are ignored.

Speaker Audio Processing Bypass Path

In applications where the audio processing in the main speaker path is not desired, the device provides a bypass path. The bypass path is selected with the [PCM_BYPASS_EN](#) bit field. The PCM data input channel for the speaker audio processing bypass path is selected with the [PCM_BYPASS_SOURCE](#) bit field.

Bypass Path Data Inversion

The input data to the audio processing bypass path can optionally be inverted by setting the [BYP_INVERT](#) bit to 1.

Bypass Path Dither

The input data to the audio processing bypass path can optionally have dither (± 1 LSB peak-to-peak) applied if [SPK_DITH_EN](#) is set to 1. No dither is applied when [SPK_DITH_EN](#) is set to 0. The [SPK_DITH_EN](#) bit also controls the dither applied to the audio playback path.

Bypass Path DC Blocking Filter

A DC blocking filter can be enabled on the audio processing bypass path by setting the [SPK_DCBLK_EN](#) bit to 1. The [SPK_DCBLK_EN](#) also controls the DC blocking filter in the audio playback path.

Speaker Maximum Peak Output Voltage Scaling

The device operates over a large PVDD supply voltage range, and as a result, the full-scale speaker amplifier output amplitude level is configurable to allow it to be scaled. As a baseline, the full-scale output of the speaker path DAC is 3.50dBV (typical). The speaker path no-load maximum peak output voltage level (V_{MPO}) is then programmable relative to this baseline level. The peak output scaling range is from +6dB to +27dB and is set with the [SPK_GAIN_MAX](#) bit field.

The speaker output signal level (in dBV) for a given digital input signal level (in dBFS) is calculated as follows:

$$\text{Output Signal Level (dBV)} = \text{Input Signal Level (dBFS)} + 0.35 \text{ (dBV)} + \text{SPK_GAIN_MAX (dB)}$$

(0dBFS is referenced to 0dBV)

The peak output voltage scaling is applied to the signal path using a combination of digital gain and analog gain adjustments.

Dynamic Headroom Tracking (DHT)

The device features dynamic headroom tracking (DHT) that can preserve consistent signal distortion and listening levels in the presence of a varying supply level. The DHT block provides both a dynamic range compressor (DRC) and a limiter. The limiter can operate as either a signal distortion limiter (SDL) or a standard signal level limiter (SLL). Each of these three functions can be used independently (modes 1 through 3), and the SLL and DRC can be used simultaneously (mode 4).

The DHT block is enabled with the [DHT_EN](#) bit. Before enabling the DHT, the measurement ADC PVDD and VBAT channels should be configured and enabled as required based on the amplifier mode of operation. The DHT block uses the measured supply levels, and the current signal level to calculate the attenuation (if any) that is applied to the signal path. Also, the DHT block should not be disabled by setting the [DHT_EN](#) bit to 0 when the DHT is active i.e., attenuation is being applied.

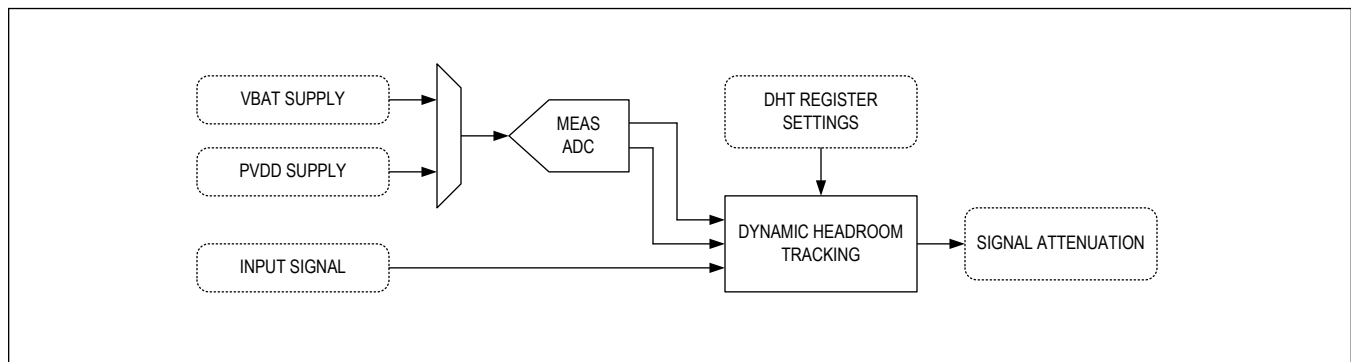

Figure 9. Simplified Dynamic Headroom Tracking System Block Diagram

DHT Supply Tracking and Headroom

The DHT block uses three parameters to track the target peak output level (V_{TPO}) relative to the maximum peak output voltage (V_{MPO}) as the active speaker amplifier supply level varies.

The first is the speaker amplifier full-scale gain setting ([SPK_GAIN_MAX](#) bit field). This control selects the maximum (no-load) peak output voltage level (V_{MPO}) that is output by the Class-DG amplifier with a full-scale input signal (0dBFS).

Most DHT thresholds and parameters are calculated relative to the full-scale V_{MPO} .

The second parameter is the measured speaker amplifier supply voltage level (V_{SUP}). The measurement ADC provides the DHT block with the current supply voltage levels (V_{PVDD} and V_{VBAT}). The DHT block decides which supply voltage to use for calculations based on the currently active speaker amplifier supply.

The third parameter is the speaker amplifier supply headroom (SUP_{HR}). The supply headroom is a positive or negative percentage offset relative to the measured V_{SUP} conversion result. It is configured using the [DHT_HR](#) bit field, and can be set from +20% to -20% of V_{SUP} in 2.5% step sizes.

The DHT target peak output voltage level (V_{TPO}) is equal to the measured supply voltage (V_{SUP}) scaled to include the selected supply headroom percentage, and is actively calculated with the following equation:

$$V_{TPO} = V_{SUP} \times (100\% - SUP_{HR})$$

The target peak output attenuation (or ratio) from V_{TPO} to V_{MPO} is calculated as follows:

$$A_{TPO} = 20 \times \log (V_{TPO}/V_{MPO})$$

If A_{TPO} exceeds 0dB (V_{SUP} with headroom $> V_{MPO}$), then the DHT block assumes that there is sufficient supply voltage to reproduce the audio signals as configured without attenuation. In this case, $A_{TPO} = 0$ dB is used for all further calculations. This is important as the DHT functions only ever apply attenuation, and never apply positive gain. Once the calculated V_{TPO} drops below V_{MPO} , the calculated target peak output attenuation (A_{TPO}) is less than 0dB, and the DHT functions are applied appropriately as the input signal level changes.

For example, if $V_{MPO} = 13.63$ V, $V_{SUP} = 8.04$ V, and $SUP_{HR} = -20\%$ then solving for V_{TPO} yields a target peak output level of ~ 9.65 V. Next, solving for the target peak output attenuation (A_{TPO}) yields approximately -3dB.

[Figure 10](#) shows the default transfer function (with no DHT attenuation applied), and where the current target peak output level (V_{TPO}) is based on the current V_{SUP} and the supply headroom settings. The tracked V_{TPO} and the resulting peak output attenuation (A_{TPO}) are then used in the attenuation calculations for the DHT functions. Note that this and all subsequent figures are not drawn to a precise scale and that the x-axis is the input signal level (dBFS) on a linear scale, while the y-axis is the peak output voltage level on a log scale.

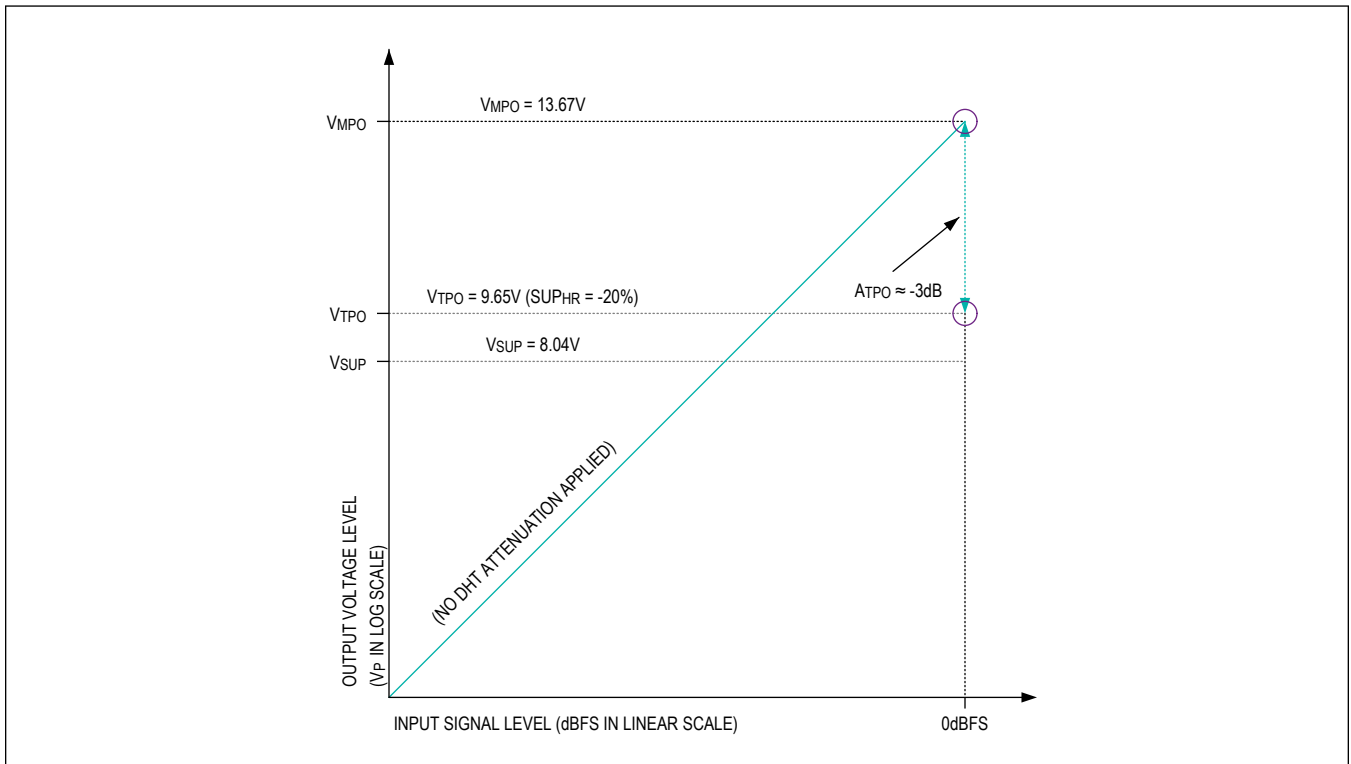

Figure 10. V_{TPO} and A_{TPO} Calculation Example

DHT Mode 1—Signal Distortion Limiter

The DHT signal distortion limiter (SDL) maintains a consistent level of signal distortion at the amplifier output as the supply voltage (V_{SUP}) changes. To use DHT mode 1 (just the signal distortion limiter active), set the [DHT_LIM_MODE](#) bit low (default) to place the limiter function in supply tracking mode (SDL), and set the dynamic range compressor rotation point ([DHT_VROT_PNT](#)) to 0dBFS (effectively disabling the DRC).

The signal distortion limiter function is a compressor with a ratio of infinity to 1 that actively sets its threshold (V_{SDL} in voltage) equal to the calculated target peak output voltage level (V_{TPO}). The output referred SDL threshold (SDL_{THR}) and the input-referred SDL knee or rotation point (SDL_{RP}) are equal in mode 1, and can be calculated relative to full-scale (in dBFS) as a ratio of V_{TPO} to V_{MPO} :

$$SDL_{RP} = SDL_{THR} = 20 \times \log(A_{TPO}) = 20 \times \log(V_{TPO}/V_{MPO})$$

The transfer function for input signal levels below the SDL rotation point (SDL_{RP}) is unchanged. When the input signal level exceeds SDL_{RP} , the signal distortion limiter function is applied to the signal path. As the input signal level increases, the distortion limiter attenuation continues to increase as well and can be calculated for a given input signal level (A_{INPUT} in dBFS) as follows:

$$SDL \text{ ATTENUATION} = SDL_{RP} - A_{INPUT}$$

By actively recalculating SDL_{RP} (or SDL_{THR}) as the target peak output level (V_{TPO}) changes, the DHT SDL maintains a consistent limit and level of amplifier output distortion relative to the available supply voltage (V_{SUP}).

When the target peak output voltage (V_{TPO}) exceeds the amplifier maximum peak output voltage (V_{MPO}), there is sufficient headroom and no SDL attenuation is applied. However, as soon as V_{TPO} falls below V_{MPO} , it is possible for the input signal amplitude to exceed the calculated SDL_{RP} . The following figures show the transfer function when $V_{SUP} \geq V_{MPO}$ with the minimum (-20%), no (0%), and maximum (+20%) supply headroom (SUP_{HR}) settings. Note that in the case with positive headroom (+20%), the SDL_{RP} falls below the input signal full-scale level even though $V_{SUP} = V_{MPO}$.

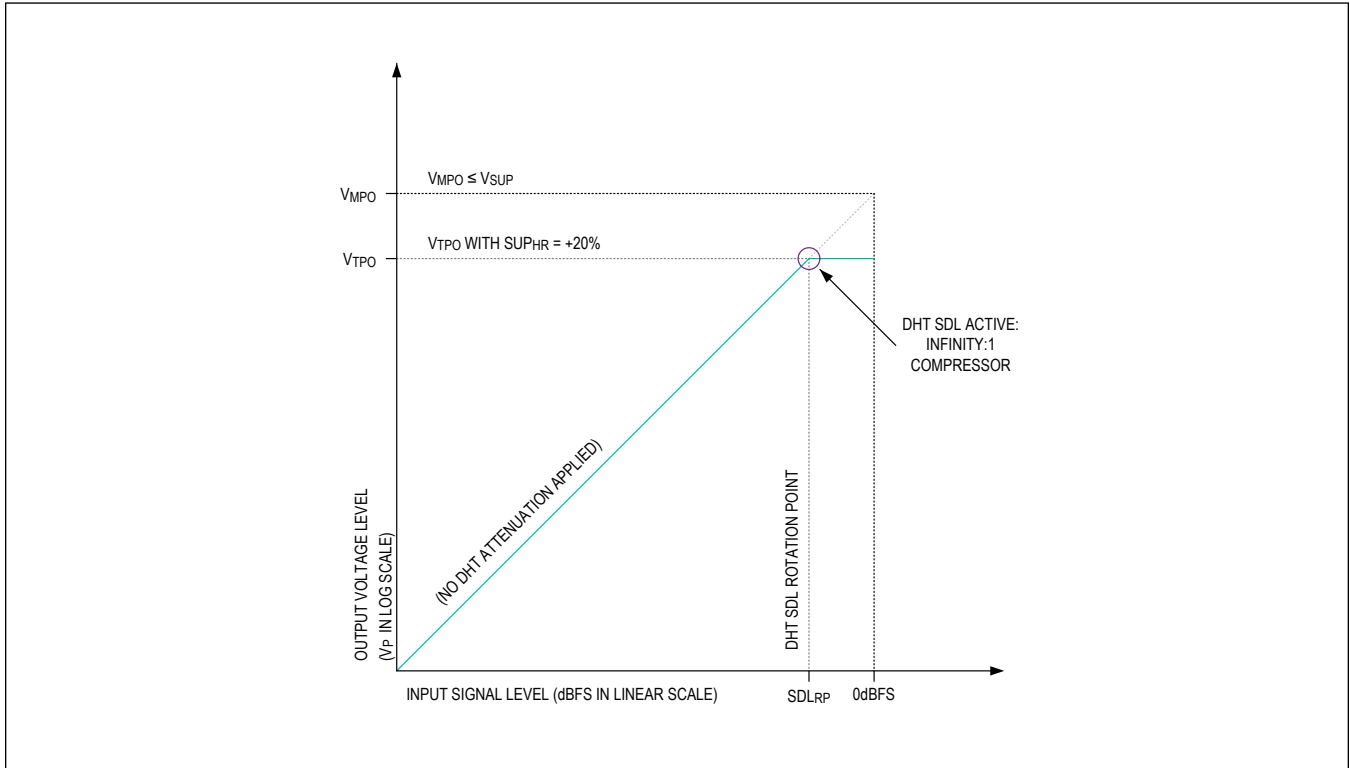

Figure 11. Signal Distortion Limiter with $V_{MPO} \leq V_{SUP}$ and +20% Headroom (SUP_{HR})

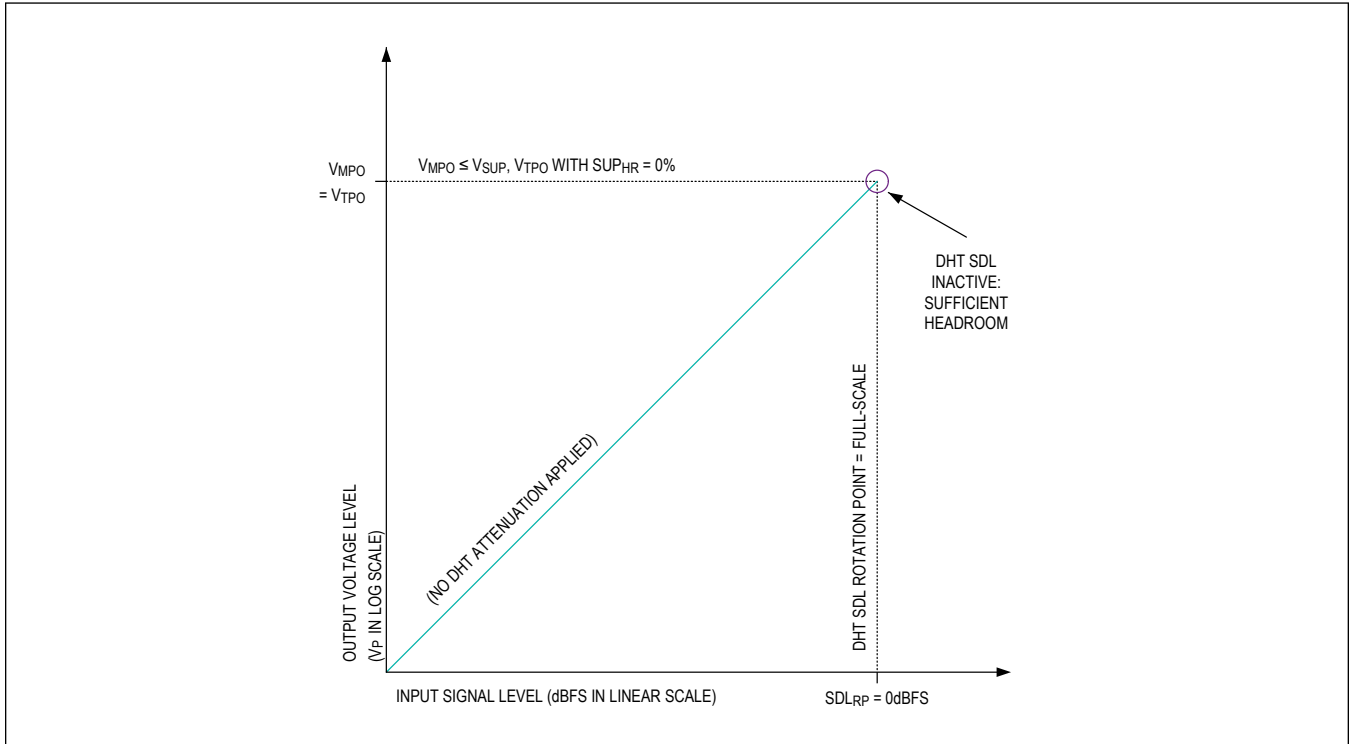

Figure 12. Signal Distortion Limiter with $V_{MPO} \leq V_{SUP}$ and 0% Headroom (SUP_{HR})

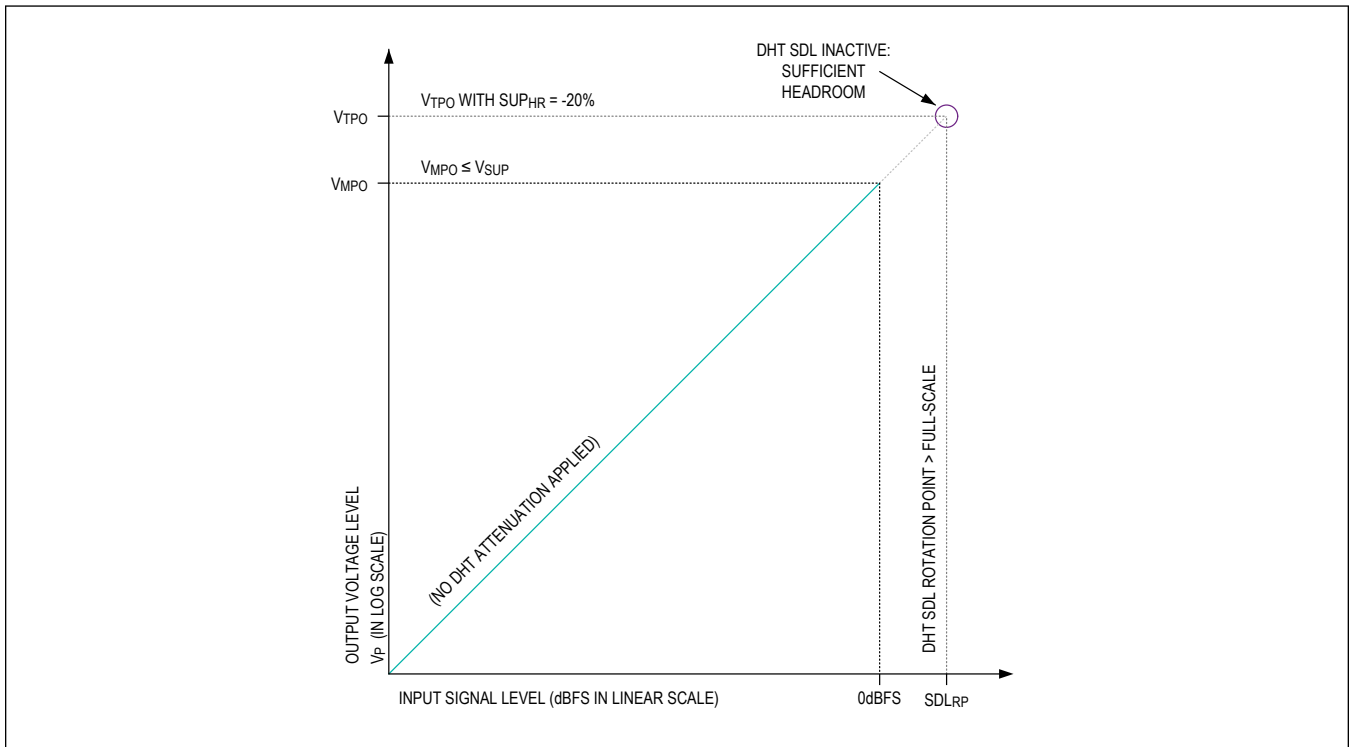

Figure 13. Signal Distortion Limiter with $V_{MPO} \leq V_{SUP}$ and -20% Headroom (SUP_{HR})

As the supply voltage (V_{SUP}) drops further below the maximum peak output voltage (V_{MPO}), the DHT target peak out voltage (V_{TPO}) proportionally scales down. In cases with zero or positive amplifier supply headroom settings ($+20\% \geq SUP_{HR} \geq 0\%$), the input signal level can exceed the SDL rotation point (SDL_{RP}) before the peak output exceeds V_{SUP} . In this case, amplifier output clipping can be prevented.

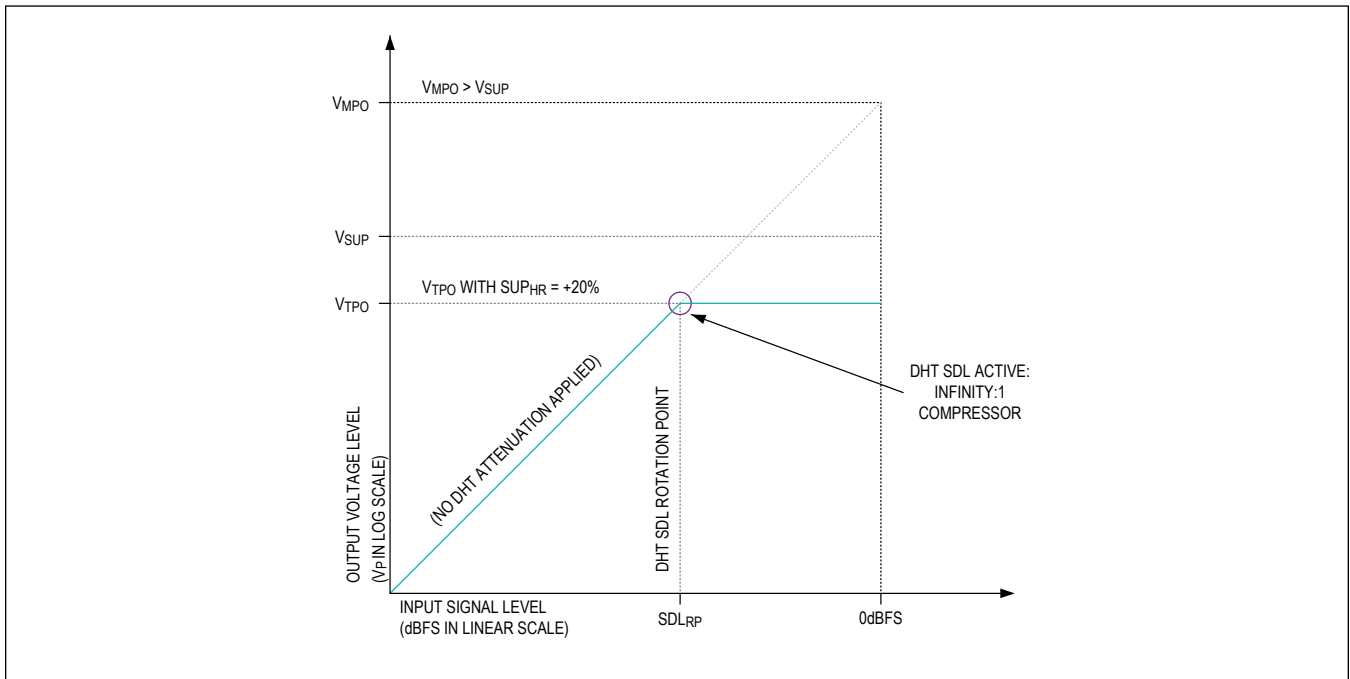

Figure 14. Signal Distortion Limiter with $V_{MPO} > V_{SUP}$ and +20% Headroom (SUP_{HR})

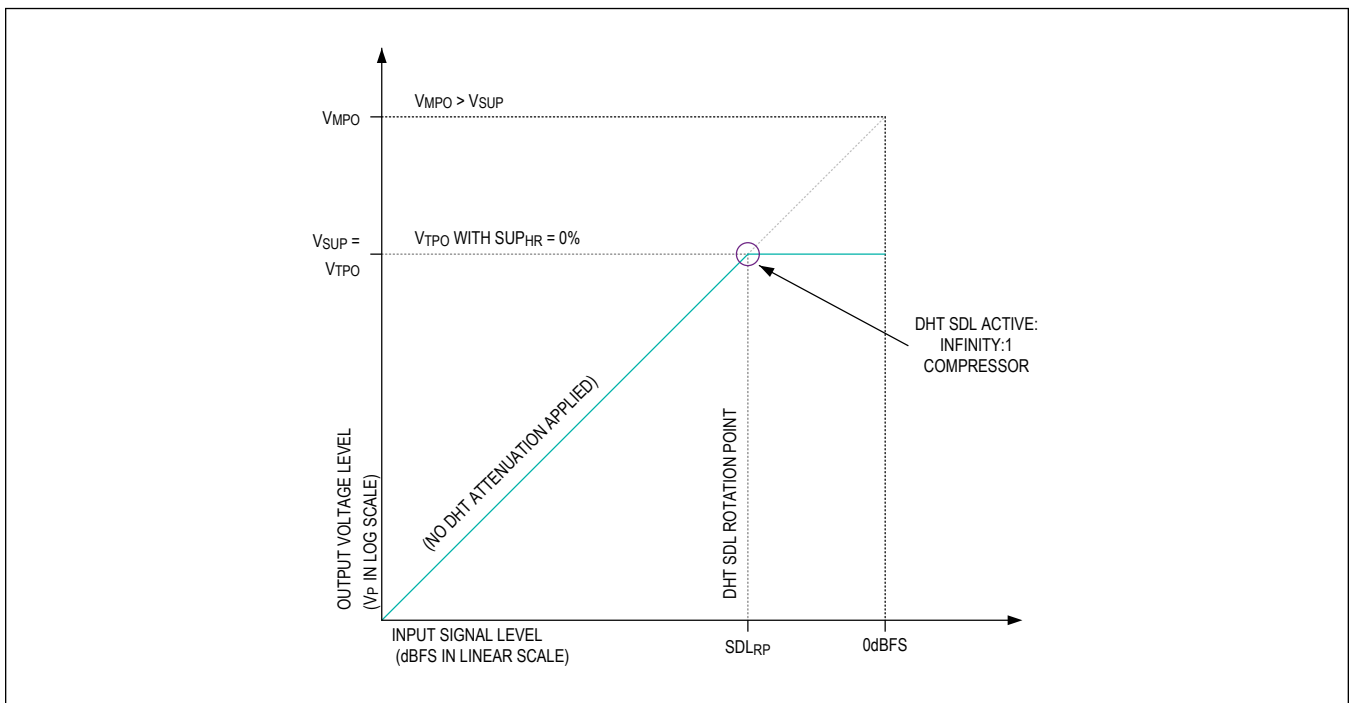

Figure 15. Signal Distortion Limiter with $V_{MPO} > V_{SUP}$ and 0% Headroom (SUP_{HR})

In cases with a negative supply headroom setting ($0\% > SUP_{HR} \geq -20\%$), the input signal does not exceed the SDL_{RP}

until after the peak output reaches V_{SUP} . As a result, clipping occurs at the amplifier output. However, once the input signal level exceeds the SDL_{RP} , the audio signal level is digitally limited by the SDL preventing the amplifier output clipping from worsening further.

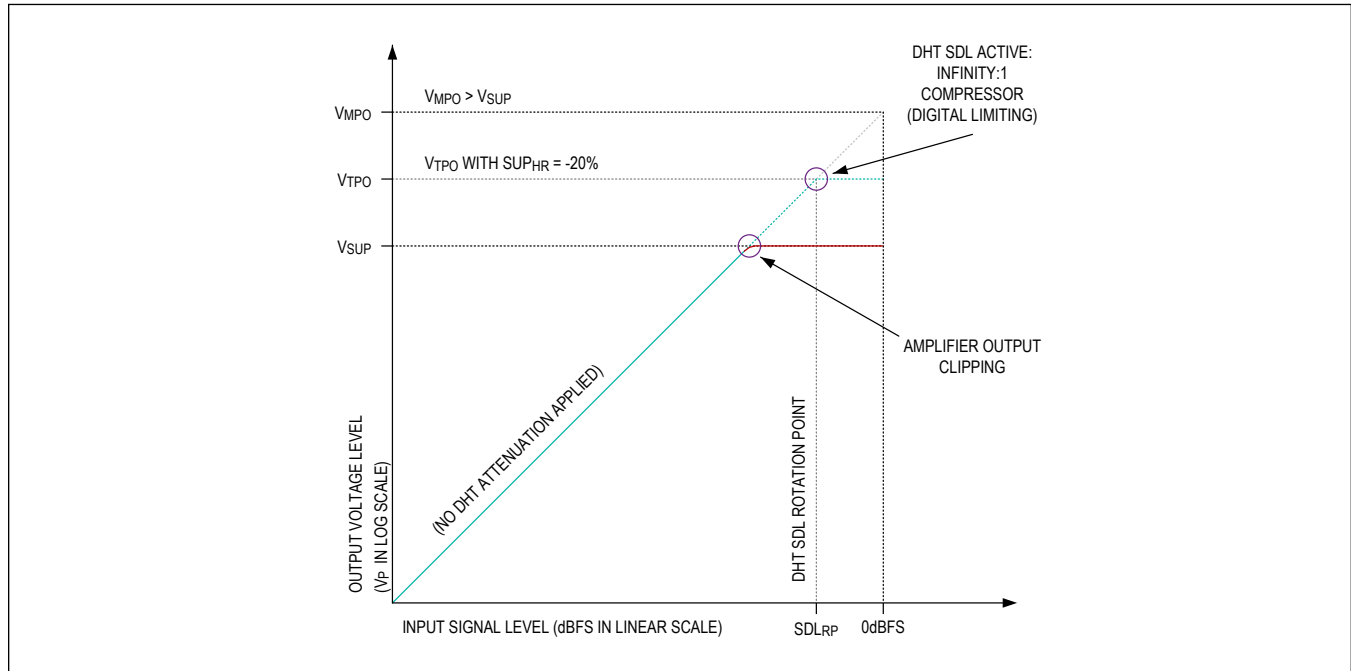

Figure 16. Signal Distortion Limiter with $V_{MPO} > V_{SUP}$ and -20% Headroom (SUP_{HR})

DHT Mode 2—Signal Level Limiter

In DHT mode 2, the limiter is configured as a fixed threshold signal level limiter (SLL). Set the [DHT LIM MODE](#) bit high to place the limiter function in SLL mode, and set the dynamic range compressor rotation point to 0dBFS (effectively disabling the DRC).

Like the signal distortion limiter, the signal level limiter function is a compressor with a ratio of infinity to 1. However, unlike the SDL, the SLL output referred threshold (SLL_{THR}) is configured to a set level. The SLL_{THR} is selected with the [DHT LIM THRESH](#) bit field from a range of 0dBFS to -15dBFS. The SLL threshold can also be expressed as an input referred knee or rotation point (SLL_{RP}) which is equal to SLL_{THR} in mode 2. The SLL amplifier peak output voltage limit (V_{SLL}) is calculated from the selected SLL threshold (SLL_{THR}) and maximum peak output voltage (V_{MPO}) with the following equation:

$$SLL \text{ PEAK OUTPUT VOLTAGE LIMIT} = V_{SLL} = V_{MPO} \times 10^{(SLL_{THR} / 20)}$$

The transfer function for signal levels below the SLL threshold (SLL_{THR}) is unchanged. When the signal level exceeds the SLL_{THR} , the signal level limiter function is applied to the signal path. As the input signal level increases, the limiter attenuation continues to increase as well and can be calculated for a given input signal level (A_{INPUT} in dBFS) relative to SLL_{RP} (= SLL_{THR}) as follows:

$$SLL \text{ ATTENUATION} = SLL_{RP} - A_{INPUT}$$

When V_{TPO} is greater than V_{SLL} , the amplifier peak output level is limited to V_{SLL} whenever the signal amplitude exceeds the SLL threshold (SLL_{THR}). As a result of the fixed SLL threshold and rotation point, the transfer function is identical for any V_{SUP} level and corresponding V_{TPO} that is greater than V_{SLL} .

This is illustrated in [Figure 17](#) for decreasing V_{SUP} and V_{TPO} levels. As V_{SUP} decreases, V_{TPO} is recalculated and decreases as well. Three different, progressively lower V_{TPO} levels are shown (V_{TPO1} , V_{TPO2} , and V_{TPO3}). Due to the fixed SLL threshold, V_{SLL} is the same in all three cases. Since all three V_{TPO} values are greater than V_{SLL} , the transfer function for each case is identical and is limited at V_{SLL} .

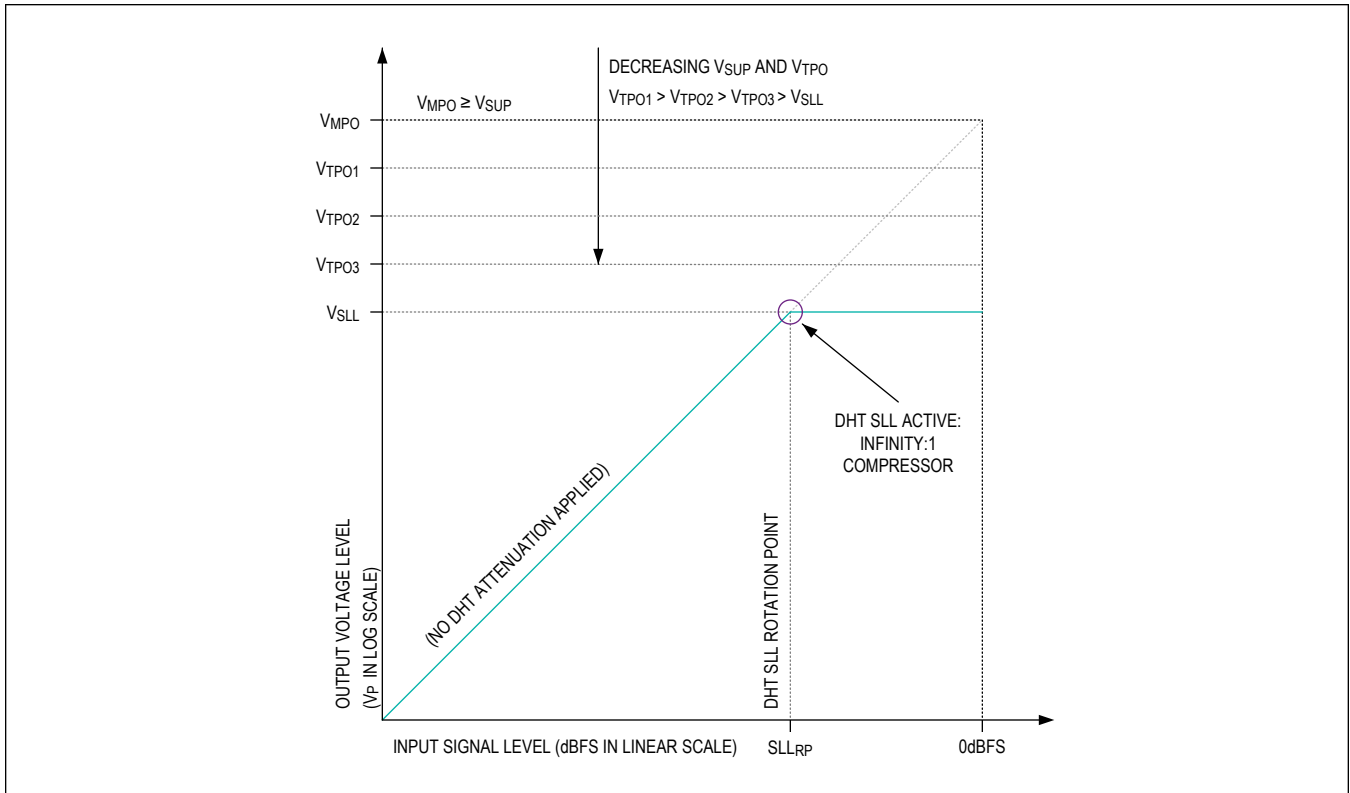

Figure 17. Signal Level Limiter with $V_{TPO} > V_{SLL}$ as V_{SUP} Decreases

When the V_{TPO} is less than V_{SLL} , the amplifier output can clip before the input signal amplitude exceeds the SLL rotation point ($SLL_{RP} = SLL_{THR}$). As the input signal level continues to increase, once it exceeds SLL_{RP} , the signal level is digitally limited preventing the amplifier output clipping from worsening further. Because both the SLL threshold and rotation point are fixed relative to full-scale, as V_{SUP} continues to decrease the clipping at the amplifier output grows progressively worse before the input signal exceeds SLL_{RP} ($= SLL_{THR}$).

Figure 18 has the same SLL settings as Figure 17 (same SLL_{THR}). For simplicity, $V_{TPO} = V_{SUP}$ ($SUP_{HR} = 0\%$), and V_{TPO} has decreased further and is now less than V_{SLL} . As a result, the amplifier output clips before the SLL digitally limits the signal level.

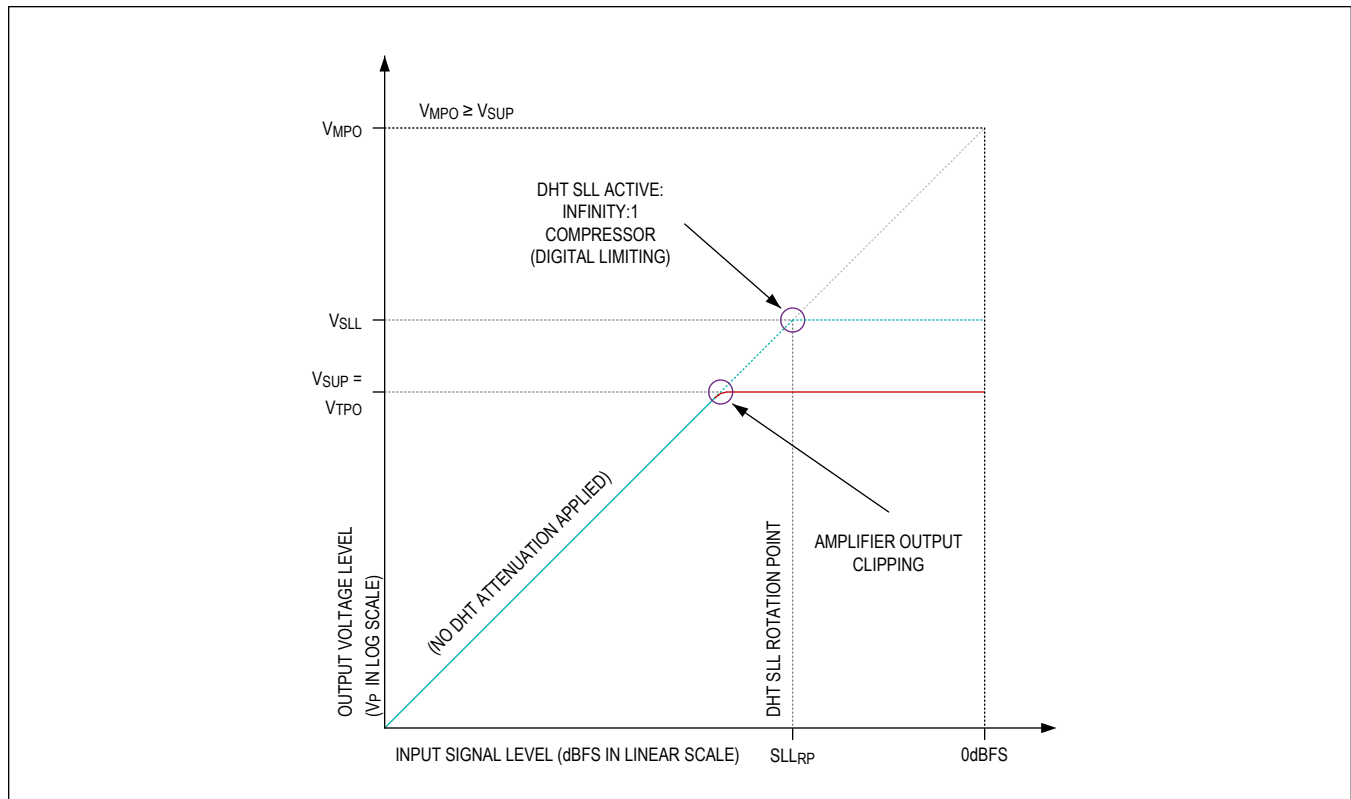

Figure 18. Signal Level Limiter with $V_{TPO} < V_{SLL}$ Showing Amplifier Output Clipping

Note: Do not use DHT_Active_Begin interrupt when SLL is active in DHT Mode 2 and DHT Mode 4 to indicate the start of DHT attenuation on the device.

DHT Mode 3—Dynamic Range Compressor

The DHT dynamic range compressor (DRC) is configured by setting the input referred rotation point (DRC_{RP} in dBFS). The DRC_{RP} can be selected from a range of 0dBFS to -15dBFS with the [DHT_VROT_PNT](#) bit field. To calculate the DRC output referred voltage threshold (V_{DRC}), use the following equation:

$$V_{DRC} = V_{MPO} \times 10^{(DRC_{RP}/20)}$$

For the mode 3 operation, set the DRC rotation point (DRC_{RP}) to any level lower than 0dBFS. Next, to disable limiter functions, place it into signal level limiter mode ([DHT_LIM_MODE](#) = 1), and set the fixed SLL threshold (SLL_{THR}) to 0dBFS (using the [DHT_LIM_THRESH](#) bit field).

Once configured, the dynamic range compressor rotation point (DRC_{RP}) is fixed at the selected level (or ratio) relative to the input full-scale. As V_{SUP} and V_{TPO} change, the DRC compression ratio for input signals exceeding DRC_{RP} changes as well. The transfer function, however, for input signals below DRC_{RP} remains unchanged. If the amplifier is operating in class-G mode, it is recommended that the DRC rotation point (DRC_{RP}) be set such that V_{DRC} exceeds the maximum possible VBAT voltage level. This ensures DRC compression is only applied when PVDD is the active amplifier supply, and that the DHT cannot rapidly switch between two different ratios if the active amplifier supply toggles quickly.

DHT tracks the target peak output voltage (V_{TPO}) and attenuation (A_{TPO}). As they change, the adaptive DRC compression ratio smoothly scales the listening level of the amplifier (for any input signals that exceed DRC_{RP}). The DRC compression ratio is actively calculated with the following formula:

$$DRC \text{ COMPRESSION RATIO} = DRC_{RP}/(A_{TPO} - DRC_{RP})$$

The DRC attenuation for a given input signal level (A_{INPUT} in dBFS) is calculated as follows:

$$DRC \text{ ATTENUATION} = A_{TPO} - A_{INPUT} \times (A_{TPO} / DRC_{RP})$$

Figure 19 shows the DRC transfer function with $SUP_{HR} \geq 0\%$ as V_{SUP} (and thus V_{TPO}) decreases. As the V_{TPO} level decreases (from V_{TPO1} to V_{TPO2} to V_{TPO3}), the DRC compression ratio increases.

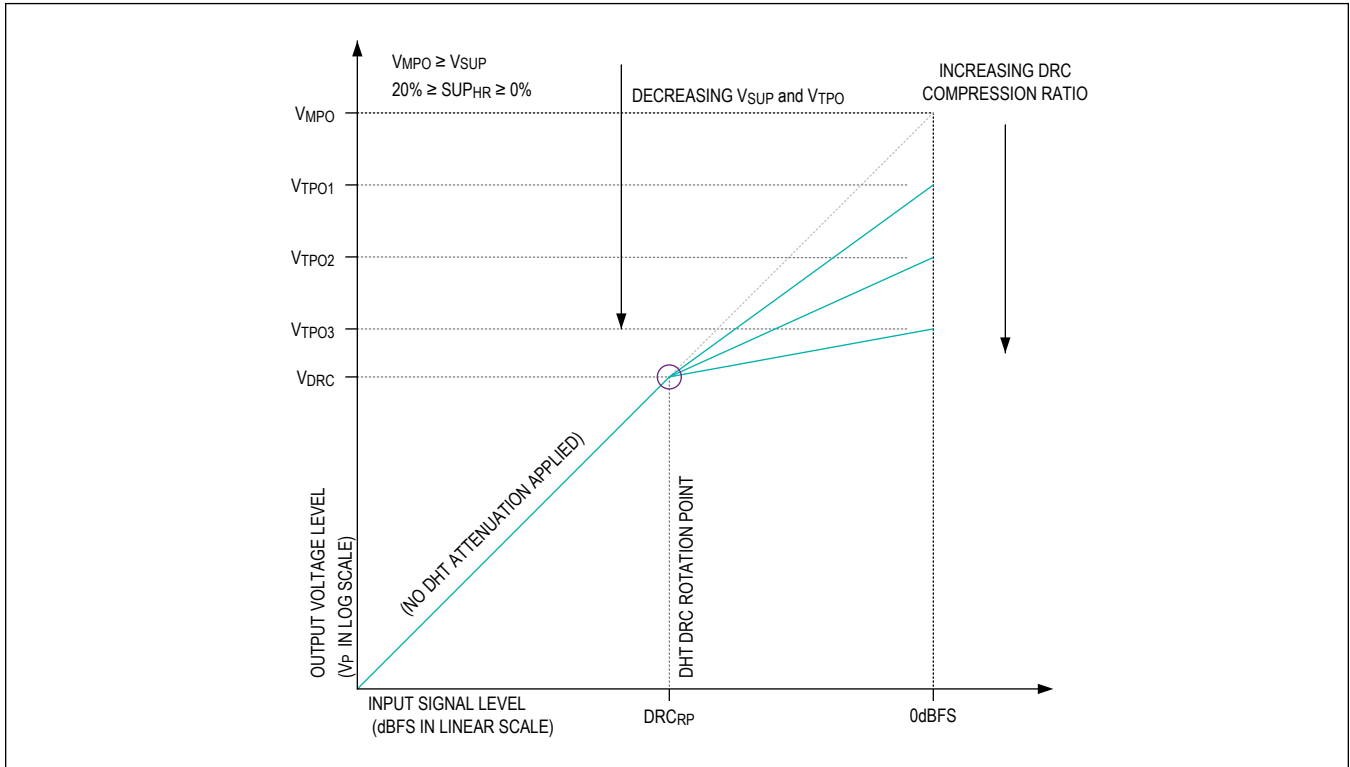

Figure 19. Dynamic Range Compression with Decreasing V_{SUP} and $SUP_{HR} \geq 0\%$

Figure 20 shows the DRC transfer function with $SUP_{HR} < 0\%$. Due to the negative supply headroom, V_{TPO} is greater than V_{SUP} and the amplifier output clips before the input signal reaches full-scale.

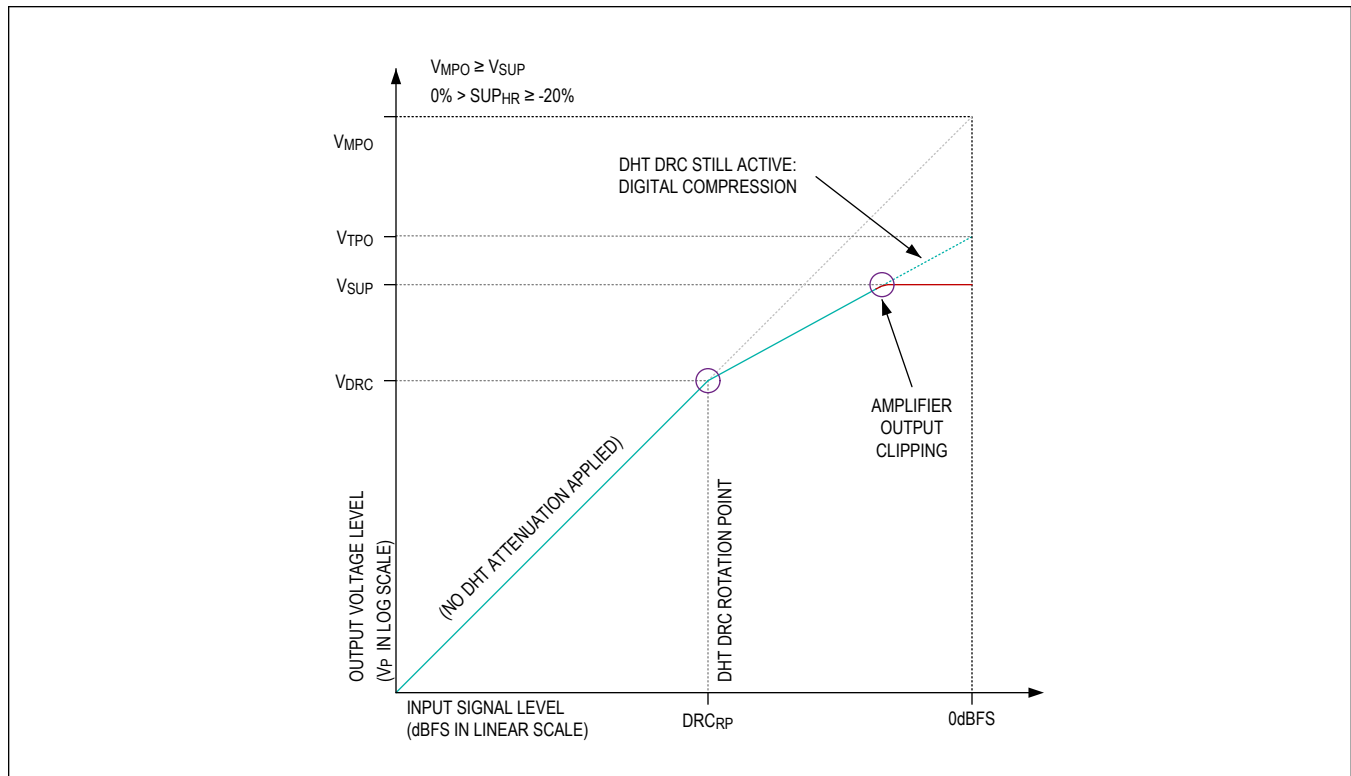

Figure 20. Dynamic Range Compressor with $SUP_{HR} < 0\%$ and Output Clipping

DHT Mode 4—Dynamic Range Compressor with Signal Level Limiter

In DHT mode 4, the dynamic range compressor (DRC) and signal level limiter (SLL) are both enabled. To allow mode 4, the DRC rotation point (DRC_{RP}) must be less than 0dBFS. In addition, the DHT limiter function must be configured for SLL mode ($DHT_LIM_MODE = 1$) with an SLL threshold (SLL_{THR}) less than 0dBFS. Finally, to create a DHT response curve with both DRC and SLL inflection points, the SLL threshold (V_{SLL}) must be greater than the DRC voltage threshold (V_{DRC}). This ensures that the resulting SLL_{RP} is always greater than the DRC_{RP} (otherwise, the SLL limits the signal level before the DRC rotation point is ever reached).

Figure 21 shows three mode 4 transfer functions for three progressively lower V_{SUP} levels. The supply headroom is configured for $SUP_{HR} > 0\%$ (positive supply headroom), and the calculated V_{TPO} value is falling (such that $V_{TPO1} > V_{TPO2} > V_{TPO3}$). The DRC rotation point and SLL threshold are constant in all three cases, and SLL_{THR} is selected such that as V_{TPO} falls the SLL knee (SLL_{RP}) is greater than the DRC_{RP} .

In the first two cases (for V_{TPO1} and V_{TPO2}), the calculated SLL output voltage limit (V_{SLL}) is less than V_{TPO} . As the signal level increases it is first compressed (by the DRC function), and then limited once the output level reaches V_{SLL} . In the third case, V_{SLL} is greater than V_{TPO3} and the signal level (while still compressed by the DRC) reaches full-scale before exceeding V_{SLL} , and the SLL limiter function is never applied.

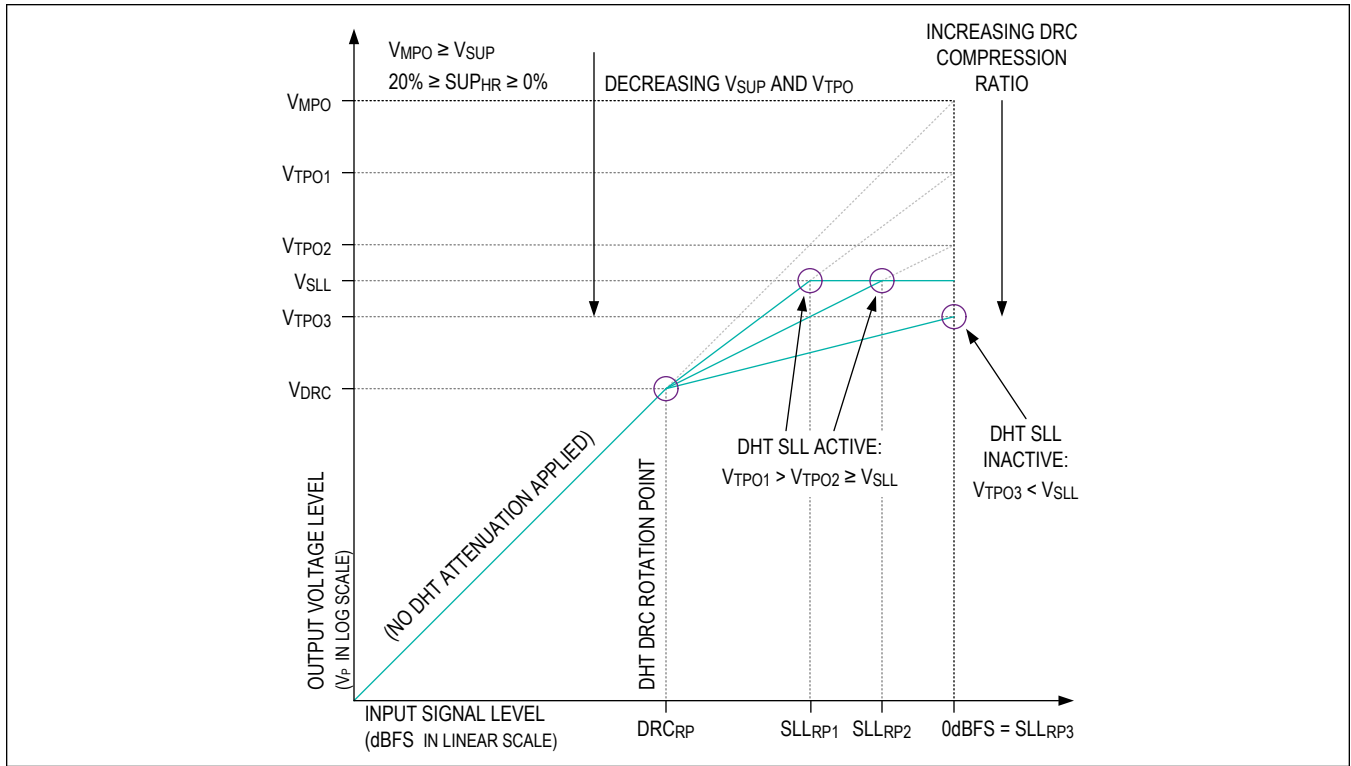

Figure 21. DHT DRC and SLL with Decreasing $V_{SUP}(V_{TPO})$, and $SUP_{HR} \geq 0\%$

Figure 22 shows a mode 4 transfer function where the supply headroom is negative ($SUP_{HR} < 0\%$). As before, the SLL threshold (SLL_{THR}) is programmed so that the resulting SLL_{RP} is greater than the DRC_{RP} . This also ensures that the resulting V_{SLL} is greater than V_{DRC} and less than V_{TPO} . As the audio signal level increases, it is first compressed (by the DRC function) and then limited once the digital output signal level reaches V_{SLL} . However, due to the negative headroom, the amplifier output clips before the SLL function digitally limits the signal level.

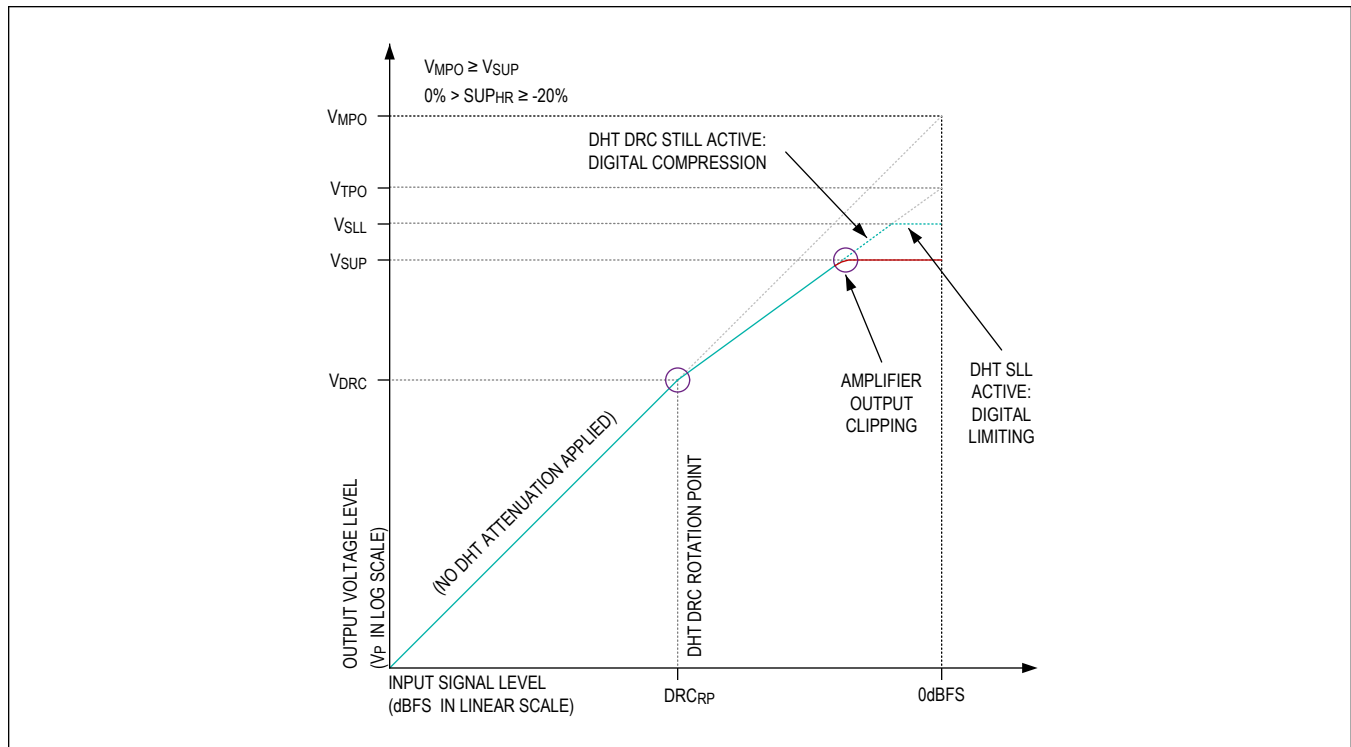

Figure 22. DHT DRC and SLL with Decreasing $V_{SUP}(V_{TPO})$, and $SUP_{HR} < 0\%$

DHT Attenuation

When the DHT block first applies attenuation, an interrupt is generated ([DHT_ACTIVE_BGN *](#)). When the DHT block fully releases all applied attenuation (i.e., DHT is inactive) an interrupt is generated ([DHT_ACTIVE_END *](#)). Interrupts are not generated when DHT is actively adjusting the level of attenuation.

The maximum attenuation (A_{MAX}) applied to the audio signal by the DHT functions is selected with the [DHT_MAX_ATN](#) bit field. The maximum attenuation can be set from -1dB to -15dB with a 1dB step size. The configured DHT functions stop further attenuation of the audio signal once the calculated attenuation (relative to the un-attenuated input signal level) reaches the selected maximum attenuation (A_{MAX}). If the calculated attenuation (based on input signal level and measured V_{SUP}) exceeds the selected maximum attenuation (A_{MAX}), the applied attenuation is set equal to (limited at) A_{MAX} . This can occur anytime that the target peak output (V_{TPO}) to maximum peak output (V_{MPO}) ratio or peak output attenuation (denoted A_{TPO}) is less than (or has a larger absolute value than) A_{MAX} .

All previous examples show cases where the peak output attenuation (A_{TPO}) did not exceed the selected maximum attenuation (A_{MAX}). The figures below show signal distortion limiter use cases where V_{SUP} has decreased until $A_{TPO} < A_{MAX}$ (the DHT DRC function DRC_{RP} is set to 0dBFS as in use case 1).

In [Figure 23](#), the SUP_{HR} is set to -20%. Since $A_{TPO} < A_{MAX}$, the attenuation applied by the distortion limiter reaches the programmed maximum attenuation level before the input signal reaches full-scale. For input signals past the point where calculated attenuation is equal to A_{MAX} , the attenuation stops increasing and is now fixed at A_{MAX} . As a result, past this point the audio signal (in the digital domain) begins to increase. This results in the distortion increasing at the amplifier output (which was already clipping at the limited level of distortion).

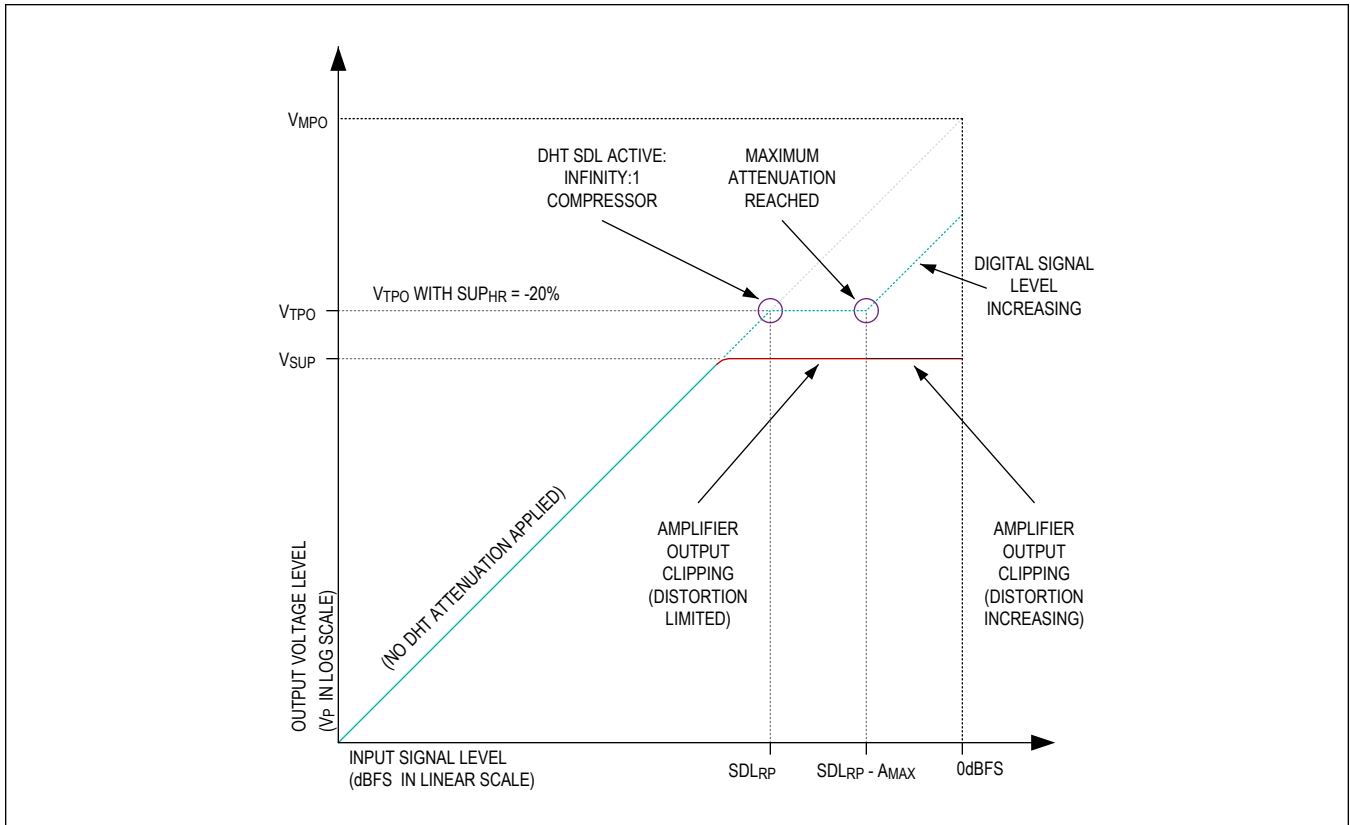

Figure 23. Distortion Limiter Case with -20% Headroom and A_{MAX} Exceeded

In [Figure 24](#), the supply headroom is set to +20%. As before, the attenuation applied by the SDL reaches the selected maximum attenuation (A_{MAX}) before the input signal reaches full-scale. Past this point, the audio signal (in the digital domain) begins increasing, and the signal level (and any distortion) at the amplifier output increases as well. In this case, the amplifier output was not clipping until after A_{MAX} was exceeded.

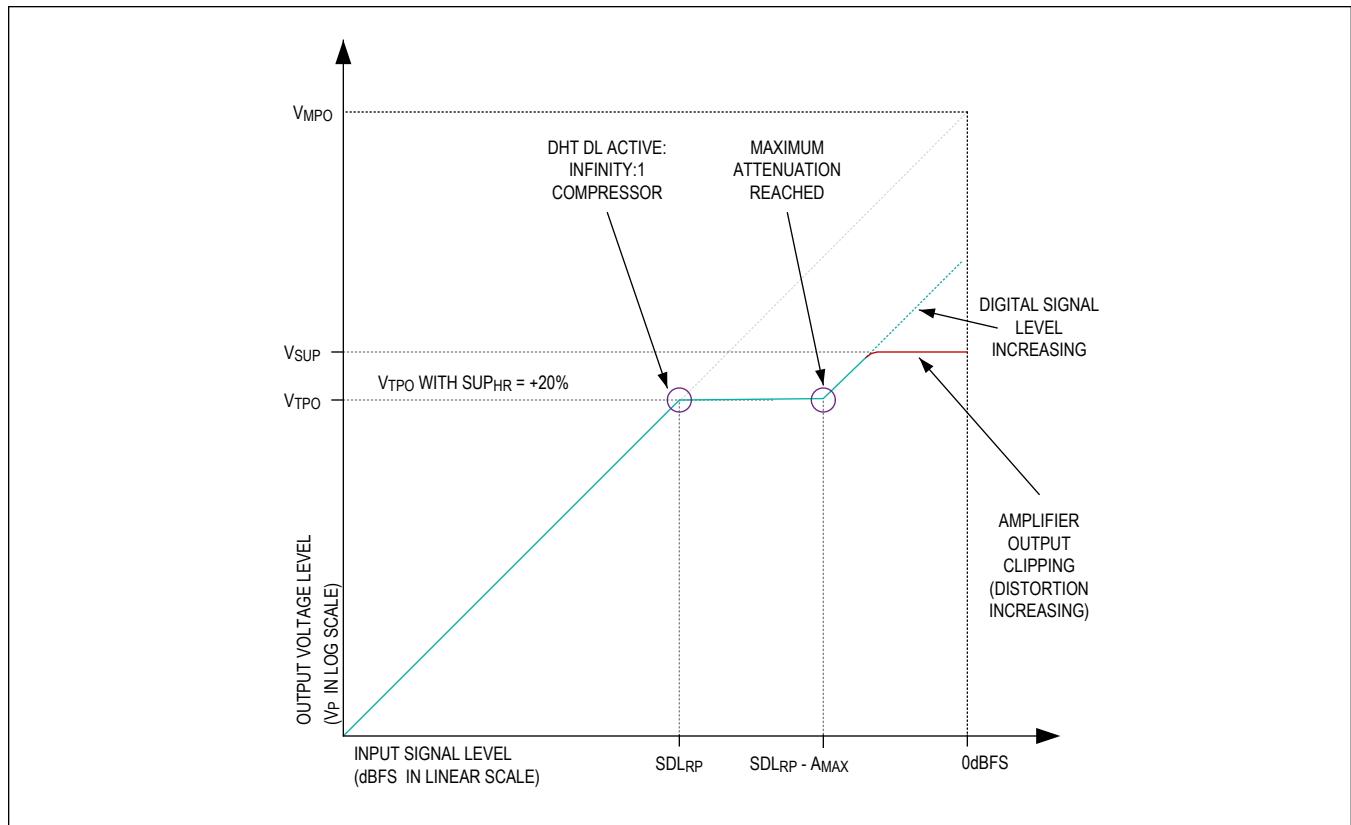

Figure 24. Distortion Limiter Case with +20% Headroom and A_{MAX} Exceeded

DHT Attenuation Reporting

In TDM mode, the current level of DHT attenuation is reported on the PCM data output (DOUT) when the DHT attenuation transmit enable bit is set high ($PCM_DHT_ATN_EN = 1$). The DHT attenuation level output is transmitted as a 14-bit unsigned binary attenuation level.

$$DOUT \text{ CURRENT DHT ATTENUATION (dB)} = 20 \times \log(14\text{-bit DOUT Value} / 16383)$$

If enabled, the DHT attenuation target (in dB) is also shared between devices on the Inter Chip Communication (ICC) bus. In this case, the DHT attenuation level output requires two ICC output slots (8 bits each) and is transmitted as a 10-bit unsigned binary attenuation level (DHT_ATN) followed by 6 bits of zero padding.

The current DHT attenuation (in dB) is calculated from the 10-bit value (DHT_ATN) with the following equation:

$$ICC \text{ CURRENT DHT ATTENUATION (dB)} = - (DHT_ATN[9:0] \times 0.015625\text{dB})$$

The current DHT attenuation level cannot exceed the selected DHT maximum attenuation (A_{MAX}). Additionally, when the DHT is inactive, the reported attenuation is 0x0.

DHT Ballistics

When the signal level exceeds the rotation point or threshold for a configured DHT function (SDL, SLL, and/or DRC) or continues to increase beyond this point, the appropriate level of attenuation is applied to the signal level at the programmed attack rate. The DHT attack rate is selected with the DHT_ATK_RATE bit field. The actual attack rates for small attenuations and faster attack rates are slightly higher than specified in the table due to a fixed 0.5ms/dB response time required by the peak detector in the path.

The change in input signal level is detected by a peak detect circuit which has a fixed 3.5ms release time. When the signal level decreases or drops below the rotation point or threshold for a configured DHT function (SDL, SLL, and/or DRC), the appropriate level of applied attenuation is released. The DHT release rate is selected with the DHT_RLS_RATE bit field.

However, due to the 3.5ms/dB peak detector, the 2ms/dB release rate is effectively 3.5ms/dB. All other release rates have a fixed delta of 3.5ms compared to the programmed release rate.

The attack and release behavior is a bit different when triggered by a change in the active amplifier supply level. When the supply level decreases and triggers a DHT function attack, the attenuation is applied quickly at the configured attack rate. Likewise, as the supply level increases, the attenuation is released at the configured release rate. However, if DHT supply hysteresis is enabled ([DHT_SUPPLY_HYST_EN](#) = 1), then as the supply increases the applied DHT function does not release attenuation until the increase in the supply level exceeds the programmed DHT supply hysteresis level ([DHT_SUPPLY_HYST](#)). Once the supply increase exceeds the hysteresis, the appropriate level of applied attenuation is released at the configured release rate.

Speaker Amplifier

The device features a Class-DG speaker amplifier output stage. The speaker amplifier playback path is enabled and disabled using the [SPK_EN](#) bit. The Class-DG multilevel amplifier generates a rail-to-rail output, pulse-width modulated (PWM) signal. By varying the PWM duty cycle, the amplifier modulates the output with the audio input signal. Because the switching frequency of the amplifier is 320kHz (typical) when the output signal is filtered by the speaker, only the audio component remains.

The default Class-D amplifier switching frequency is 320kHz, and results in the best efficiency. However, the output switching frequency is programmable and can be increased to 620kHz by setting the [TRI_FSW2X_MODE](#) bit field to 1. The increased switching frequency setting trades an improvement in THD+N performance for a reduction in amplifier efficiency.

Rail-to-rail operation ensures that power dissipation at the output is dominated by the on-resistance (R_{ON}) of the power output MOSFETs, brief saturation current draw as the output switches as well as the current draw necessary to charge the output stage gates. In MAX98397, the high-side output stage gate drive supply is provided by bootstrap pins [VBOOT_P](#) and [VBOOT_N](#). For proper operation of the bootstrap circuit, a small ceramic capacitor must be connected between the bootstrap pin ([VBOOTP](#) or [VBOOTN](#)) and the associated Class-D output pin ([OUTP](#) or [OUTN](#)).

In addition, the amplifier's output MOSFETs are segmented, and to save power they are automatically scaled based on the selected operating mode, input signal level, and configured gain structure.

Speaker Amplifier Operating Modes

The speaker amplifier can operate both in Class-DG and standard Class-D modes. In Class-DG mode, the amplifier output supply rail is switched between V_{PVDD} and V_{VBAT} based on the signal level. If Class-DG operation is disabled the amplifier operates as a fixed supply Class-D amplifier and can be configured to use either V_{PVDD} or V_{VBAT} as the output supply rail. The speaker amplifier operating mode is selected with the [SPK_MODE](#) bit field.

Class-DG Mode Enabled

Class-DG is the default speaker amplifier mode of operation ([SPK_MODE](#) = 0x0). In this mode, the amplifier switches the supply rail between $PVDD$ and $VBAT$ as needed to efficiently supply the required output power.

Additionally, if V_{VBAT} drops below a programmed threshold level [VBATLOW_OK_LVL](#) bit field the amplifier operates from $PVDD$ supply rail regardless of signal level.

The Class-DG signal level threshold ([VDG_THR](#)) at which the amplifier switches between the supply rails is programmable. The method used to program the signal level threshold is selected with the [SPK_DG_SEL](#) bit field. When [SPK_DG_SEL](#) is set to 0x0, the threshold ([VDG_THR](#)) is set to a fixed peak voltage level with the [SPK_DG_THRES](#) bit field. When [SPK_DG_SEL](#) is set to 0x1 (default), the threshold ([VDG_THR](#)) is variable relative to the current $VBAT$ voltage (measurement ADC result). The peak voltage headroom relative to V_{VBAT} is configured with the [SPK_DG_HEADROOM](#) bit field. Finally, if [SPK_DG_SEL](#) is set to 0x2, the threshold ([VDG_THR](#)) is set based on whichever setting ([SPK_DG_THRES](#) and [SPK_DG_HEADROOM](#)) results in the lowest threshold for the current V_{VBAT} voltage level. As a result, as V_{VBAT} decreases [VDG_THR](#) may transition from a fixed threshold to a lower V_{VBAT} headroom-based variable threshold.

The Class-DG mode hold time is configured with the [SPK_DG_HOLD_TIME](#) bit field. To save power, when the signal level drops below the threshold for longer than the hold time, $VBAT$ is selected as the active amplifier supply. The amplifier switches to the $VBAT$ supply only at signal zero cross so the measured hold time is the register-configured hold time plus the time taken for a zero cross event to occur. When $VBAT$ is the active amplifier output supply, the [LV_EN](#)

output asserts high. When the signal level rises above the threshold, the amplifier supply quickly switches to PVDD to provide a higher output voltage swing and to avoid clipping. When PVDD is the active amplifier output supply, the LV_EN output asserts low.

Delay for DG Mode

When the amplifier is operating in the automatic Class-DG mode, to avoid the potential for clipping the output signal as the PVDD supply rises, there is a programmable delay in the signal path controlled by [SPK_DG_DELAY](#). This allows the PVDD supply time to increase the output voltage before it is required to output larger signals.

Class-DG Mode Disabled

When Class-DG mode is disabled the speaker amplifier operates in standard Class-D mode. In this case, the active amplifier output supply is configured to either PVDD ([SPK_MODE](#) = 0x1) or VBAT ([SPK_MODE](#) = 0x2).

If the active amplifier output supply is configured to VBAT ([SPK_MODE](#) = 0x2), the amplifier operates from VBAT regardless of signal level. In this mode, the LV_EN pin is asserted high.

When the active amplifier supply is set to PVDD, the amplifier always operates from PVDD regardless of the signal and supply levels. Furthermore, to save power PVDD can be actively regulated between any levels within its standard operating range (3V to 28V). In this mode, LV_EN pin is always asserted low.

IDLE Mode

In customer systems where an external LC filter is used for EMI reduction, the quiescent power consumption and power consumption in DG Mode for low signal levels can be reduced by setting the [IDLE_MODE_EN](#) bit-field to 1. The Idle mode setting is not intended for operation in PVDD mode (with the VBAT pin supplied externally) and should not be enabled.

When the idle mode is enabled, the idle mode activates whenever the amplitude of the input audio data to the speaker path (from the PCM interface) is below the configured mute threshold ([NG_MUTE_THRESH](#)) for more than 1024 consecutive data samples. When the idle mode is active the current and voltage sense ADC paths output zero code data. The idle mode deactivates immediately if the amplitude of a single sample from the input audio data exceeds the configured unmute threshold ([NG_UNMUTE_THRESH](#)). When the idle mode deactivates the current and voltage sense ADC paths resume operation and output data normally.

The idle mode mute and unmute threshold settings are selected in terms of the number of bits (starting from the LSB) that must be toggling (or active) for the input signal amplitude to exceed the thresholds. It is invalid to set the noise gate unmute threshold ([NG_UNMUTE_THRESH](#)) such that it is less than the configured mute threshold ([NG_MUTE_THRESH](#)). The location of the audio data LSB within the PCM input data channel is determined by the configured PCM data word size ([PCM_CHANSZ](#)). The supported combinations are shown in [Table 8](#).

It is not valid to enable idle mode and noise gate functions simultaneously.

Speaker Amplifier Ultra-Low EMI Filterless Operation

Traditional Class-D amplifiers require the use of external LC filters, or shielding, to meet electromagnetic-interference (EMI) regulation standards. However, the device features emissions-limiting circuitry that limits the output switching harmonics that can directly contribute to EMI and radiated emissions.

The programmable speaker amplifier edge rate control bits are used to adjust the switching edge rate to help tune EMI performance. As the edge rate increases, the efficiency improves slightly, while as the edge rate is decreased, the efficiency drops slightly. The speaker amplifier edge rate is configured with the [SPK_SL_RATE_GMODE](#), [SPK_SL_RATE_LS](#), and [SPK_SL_RATE_HS](#) bit fields.

The speaker amplifier output also supports spread spectrum modulation (SSM). SSM is enabled by default, and it optimizes the suppression and control of the output switching harmonics that can contribute to EMI and radiated emissions. The modulation index in spread-spectrum mode is controlled by the [TRI_SSM_MOD](#) bit field, and the maximum modulation index (MMI) varies accordingly. Higher percentage settings of the modulation index result in the switching frequency of the amplifier being modulated by a wider range, spreading out-of-band energy across a wider bandwidth. Above 10MHz, the wideband spectrum looks like noise for EMI purposes.

Speaker Amplifier Overcurrent Protection

The device features amplifier current limit protection that protects the amplifier output from both high current and short circuit events. If the [OVC_AUTORESTART_EN](#) bit is set to 1 and the speaker amplifier output current exceeds the current limit threshold (8.3A min.), the device generates an interrupt and disables the amplifier output. After ~20ms, the amplifier output is re-enabled. If the overcurrent condition still exists, the device continues to disable and re-enable the amplifier output automatically until the fault condition is removed.

If the [OVC_AUTORESTART_EN](#) bit is set to 0, when a speaker amplifier overcurrent event occurs the device still generates an interrupt and disables the amplifier output. However, in this case the device is placed into software shutdown and the software enable ([EN](#)) bit is set to 0. As a result, the host must manually re-enable the device after an overcurrent event.

Speaker Current and Voltage Sense ADC Path

The device provides two separate 16-bit ADCs to monitor the speaker amplifier output current and voltage (the I/V sense ADC path). The current and voltage ADC paths are independently enabled with the [IVADC_I_EN](#) and [IVADC_V_EN](#) bits respectively. Voltage and Current ADC data is output through the PCM interface data output (DOUT) which is enabled by the [PCM_TX_EN](#) bit field.

For accurate voltage measurements, the OUTPSNS and OUTNSNS pins should be Kelvin connected as close as possible to the load connected between OUTP and OUTN. If a filter is installed between the speaker amplifier output pins and the load, then the sense lines should be connected close to the load and after the filter. The speaker amplifier current is measured internally and requires no external connections.

The voltage and current digital data output are routed to the host through the PCM interface. Both the current and voltage sense ADC output data can optionally have dither applied (± 1 LSB peak-to-peak) by setting the [IVADC_DITH_EN](#) bit field to 1. No dither is applied when [IVADC_DITH_EN](#) is set to 0.

The I/V sense ADC path provides separate optional DC blocking filters (first-order highpass) in the current and voltage sense paths. The current and voltage path filters are enabled by setting the [IVADC_I_DCBLK_EN](#) and [IVADC_V_DCBLK_EN](#) bit fields to 1 respectively.

To ensure phase alignment, the current and voltage sense ADCs should be enabled either with a single write to the [IVADC_I_EN](#) and [IVADC_V_EN](#) bits ([EN](#) = 1) or by setting both bits high before exiting software shutdown.

Brownout-Prevention Engine

The brownout-prevention engine (BPE) allows the device to reduce its contribution to the overall system power consumption by attenuating the amplifier output when the supply drops below a set of programmable thresholds. The BPE is enabled and disabled using the [BPE_EN](#) bit. The BPE can be enabled at any time by setting the [BPE_EN](#) bit high. However, the BPE must not be disabled when it is active (in critical supply levels 0 through 3). The BPE can be disabled safely at any time that it is inactive. The input to the BPE controller is selected using the [BPE_SRC_SEL](#) bit. By default, the input to the BPE controller is the measurement ADC PVDD channel. If the selected measurement ADC channel is not already active, enabling the BPE will automatically enable it. The sample rate and filter settings for the measurement ADC determine the speed at which the BPE updates. Note that the signal limiter block acts on the audio data before the gain reduction block in the speaker playback data path.

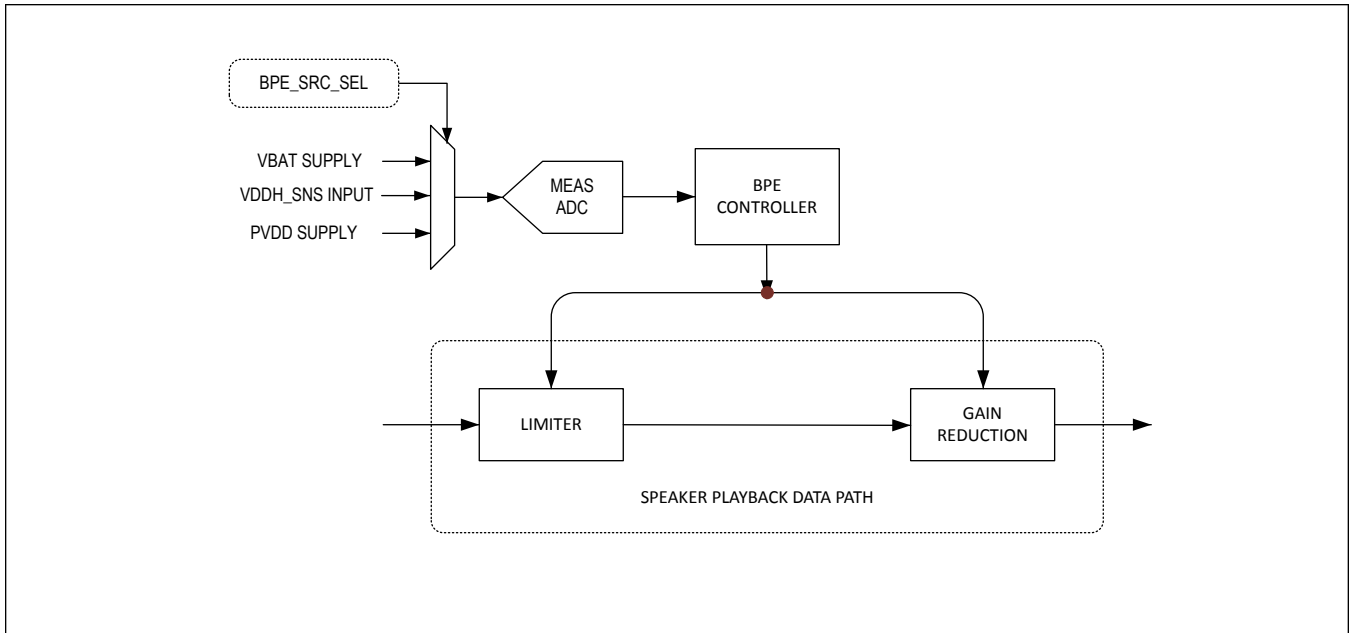

Figure 25. BPE Block Diagram

BPE State Controller and Level Thresholds

There are a total of four BPE critical supply levels each with individually programmable thresholds. The thresholds for each level are configured with the [BPE_L0_VTHRESH](#) to [BPE_L3_VTHRESH](#) bit fields respectively. The BPE state controller monitors the measurement ADC channel results and automatically makes state changes.

Table 9. Brownout-Prevention Engine Levels

THRESHOLD NAME	CONDITION
BPE Inactive	$V_{SUPPLY} > \text{Critical Supply Level 3}$
Critical Supply Level 3	$\text{Critical Supply 3} \geq V_{SUPPLY} > \text{Critical Supply Level 2} + \text{Hysteresis}$
Critical Supply Level 2	$\text{Critical Supply Level 2} \geq V_{SUPPLY} > \text{Critical Supply Level 1} + \text{Hysteresis}$
Critical Supply Level 1	$\text{Critical Supply Level 1} \geq V_{SUPPLY} > \text{Critical Supply Level 0} + \text{Hysteresis}$
Critical Supply Level 0	$V_{SUPPLY} \leq \text{Critical Supply Level 0}$

The brownout engine supports hysteresis on the levels. This behaves as follows:

- When in level N, transition to level N + 1 when V_{SUPPLY} stays above (level N threshold) + (hysteresis).
- When in level N, transition to level N - 1 when V_{SUPPLY} falls below the level N threshold.

The amount of hysteresis is defined by the [BPE_VTHRESH_HYST](#) register. and the hysteresis is only applied to the thresholds when the supply voltage is increasing. The amount of hysteresis can be defined as larger than the distance between two levels.

Thresholds must be configured so that the level N threshold is greater than the sum of the level N - 1 threshold and the hysteresis. For example, if the level 2 threshold is set to 3.15V and hysteresis is set to 25mV, then the level 3 threshold must be set to 3.1875V or higher.

The current level that the BPE is in can be read-back using the [BPE_STATE](#) register. The [BPE_LOWEST](#) register contains the lowest BPE level that the controller has visited since the last time the [BPE_LOWEST](#) register was read.

BPE Level Configuration Options

For a given BPE level, the following options are configurable to reduce the overall device current draw:

- Gain Attenuation Function

- Limiter Function

Each of these configuration options are individually configurable for each BPE level.

BPE Gain Attenuation Function

The speaker gain attenuation block reduces the overall current drawn by the device at low supply voltages by applying smooth digital gain changes to the signal path. For each BPE level, the maximum attenuation that can be applied can be independently configured. The maximum attenuation that can be applied for each level is programmable from 0 to -31dB in 1dB steps and is configured using the [BPE_Lx_MAXATTN](#) bits.

When the V_{SUPPLY} voltage level falls below the programmed level, the brownout controller waits for a time equal to the programmed dwell time for the level before applying attenuation at the programmed attack rate. The brownout controller then enters the hold time phase when maximum attenuation is reached or when the V_{SUPPLY} voltage increases and causes the brownout controller to enter the next level. After the programmed hold time for a BPE level expires, the controller enters the release phase where the controller releases the attenuation at the programmed release rate. Additionally, each BPE level has independent programmable settings for dwell time ([BPE_Lx_DWELL](#)), hold time ([BPE_Lx_HOLD](#)), attack-and-release step size ([BPE_Lx_STEP](#)), attack rate ([BPE_Lx_GAIN_ATK](#)), and release rate ([BPE_Lx_GAIN_RLS](#)). While the attack-and-release rates are independently configurable for the gain attenuation and limiter block, the attack-and-release step size settings are common.

BPE Limiter Function

The BPE limiter function allows the device to reduce the overall current draw at low supply levels by quickly attenuating (<15us) input signals that exceed a programmed threshold. When the BPE limiter is enabled ([BPE_LIM_EN](#) = 1), the device ignores the signal distortion limiter and signal level limiter settings in the DHT. In this state, the limiter knee threshold is determined solely by the BPE limiter setting of the current BPE level. Each BPE level has an individually configured limiter threshold (set by [BPE_Ln_LIM](#)) that is programmable from 0dBFS and -15dBFS in 1dB steps.

Input signals that exceed the limiter knee threshold are attenuated, while input signals below the threshold are not. Each BPE level has an individually configured attack-and-release step size ([BPE_Lx_STEP](#)), attack rates ([BPE_Lx_LIM_ATK](#)) and release rates ([BPE_Lx_LIM_RLS](#)). While the attack-and-release rates are independently configurable for the gain attenuation and limiter block, the attack-and-release step size settings are common.

The [BPE_LOWEST_LIMIT](#) register contains the lowest limiter setting applied to the brownout controller. The register is updated upon reading to show the current limiter setting applied by the BPE.

Brownout Interrupts

The BPE can generate interrupts triggered by the following conditions:

- BPE controller enters level 0 ([BPE_L0_*](#))
- BPE controller changes from one level to another ([BPE_LEVEL_*](#))
- BPE controller is active ([BPE_ACTIVE_BGN_*](#))
- BPE controller is no longer active ([BPE_ACTIVE_END_*](#))

See the [Interrupts](#) section for more information.

Measurement ADC

The device features a configurable 9-bit measurement ADC. The measurement ADC has four channels, one for die temperature measurement (measurement ADC thermal channel), one for PVDD supply voltage measurement (measurement ADC PVDD channel), one channel for VBAT supply voltage measurement (measurement ADC VBAT channel), and one channel for external supply sense voltage measurement (measurement ADC VDDH_SNS channel). Enabled channels are measured sequentially and continuously.

The measurement ADC sample rate is programmable in regular mode ([MEAS_ADC_OPT_MODE](#) = 0) and it can be set independently for each channel. In addition, the device provides two measurement ADC optimal sample rate modes ([MEAS_ADC_OPT_MODE](#) > 0) that provides a fixed higher sample rate for the BPE source channel and lower sample rates for all other measurement ADC channels. Each channel separately provides an optional programmable lowpass IIR filter.

Measurement ADC Channel Optimal Mode

Measurement ADC Channel Optimal Modes provide the fastest change to the amplifier output in response to a BPE event. The VBAT and PVDD measurement ADC channels on the device must be enabled ([MEAS_ADC_PVDD_EN](#), [MEAS_ADC_VBAT_EN](#)) when using MEAS_ADC_OPT_MODE > 0. If VDDH_SNS input is used in the system, either for supply monitoring or as a BPE Source channel, the VDDH_SNS measurement ADC channel must be enabled ([MEAS_ADC_VDDH_EN](#)).

[Table 10](#) shows the measurement ADC sample rates for the different measurement ADC channels in the two measurement ADC optimal modes.

Table 10. Measurement ADC Channels Sample Rate in Optimal Modes

MEAS_ADC_OPT_MODE	BPE SOURCE	BPE SOURCE SAMPLE RATE	THERMAL CHANNEL SAMPLE RATE	SECONDARY SUPPLY CHANNEL SAMPLE RATE	VDDH_SNS ADC CHANNEL STATE	VDDH_SNS SAMPLE RATE
0x1	VBAT	600kHz	37.5kHz	PVDD = 300kHz	Disabled	—
	PVDD	600kHz	37.5kHz	VBAT = 300kHz	Disabled	—
	VDDH_SNS	525kHz	37.5kHz	VBAT = 300kHz PVDD = 75kHz	Enabled	525kHz
	VBAT	525kHz	37.5kHz	VBAT = 525kHz PVDD = 300kHz	Enabled	75kHz
	PVDD	525kHz	37.5kHz	VBAT = 300kHz PVDD = 525kHz	Enabled	75kHz
0x2	VBAT	900kHz	37.5kHz	PVDD = 75kHz	Disabled	—
	PVDD	900kHz	37.5kHz	VBAT = 75kHz	Disabled	—
	VDDH_SNS	825kHz	37.5kHz	VBAT = 75kHz PVDD = 75kHz	Enabled	825kHz
	VBAT	825kHz	37.5kHz	VBAT = 825kHz PVDD = 75kHz	Enabled	75kHz
	PVDD	825kHz	37.5kHz	VBAT = 75kHz PVDD = 825kHz	Enabled	75kHz

Measurement ADC Thermal Channel

When the device is clocked, in the active state (EN = 1) the measurement ADC thermal channel automatically activates. When active, it continuously measures and reports the device die temperature over the range from -29°C to +150°C.

The output of the thermal ADC channel can be read back through the [MEAS_ADC_THERM_DATA](#) bit field and is the input to both the thermal protection and thermal foldback blocks. By default ([MEAS_ADC_THERM_RD_MODE](#) = 0), the thermal readback value is automatically updated after each conversion is completed. Setting [MEAS_ADC_THERM_RD_MODE](#) to 1 places thermal readback into manual mode. In manual mode, the thermal readback result is updated manually when a 1 is written to the [MEAS_ADC_THERM_UPD](#) bit field. The ADC thermal channel data read back in manual mode and the data streamed through the PCM interface is 9 bits. In the automatic mode, since the 9-bit data readback is from two registers, the LSB register isn't guaranteed to be synchronous with the MSB register and can result in higher noise in the automatic mode.

The highest measured temperature measurement result is read back through the [HIGHEST_THERM_DATA_MSB](#) and [HIGHEST_THERM_DATA_LSB](#) bit fields. These bit fields both automatically clear and are reset to the value of the current measurement result immediately after LSB readback is completed.

The thermal ADC channel also provides an optional lowpass IIR filter with a programmable bandwidth that scales relative to the measurement ADC sample rate. The filter is enabled with the [MEAS_ADC_TEMP_FILT_EN](#) bit field and the bandwidth is set with the [MEAS_ADC_TEMP_FILT_COEFF](#) bit field.

Measurement ADC PVDD Channel

When the device is clocked and in the active state ($EN = 1$), the measurement ADC PVDD channel can be enabled. The PVDD channel is manually enabled by setting the [MEAS_ADC_PVDD_EN](#) bit to 1 and must be manually enabled for the DHT to operate. When the channel is enabled, it continuously measures and reports the PVDD supply voltage level over the range of 2.5V to 28V.

The output of the measurement ADC PVDD channel can be read back through the [MEAS_ADC_PVDD_DATA](#) bit field, and is routed to the DHT. By default ([MEAS_ADC_PVDD_RD_MODE](#) = 0), the PVDD readback value is automatically updated after each conversion is completed. Setting [MEAS_ADC_PVDD_RD_MODE](#) to 1 places PVDD readback into manual mode. In manual mode, the readback result is updated when a 1 is written to the [MEAS_ADC_PVDD_RD_UPD](#) bit field. The ADC PVDD channel data read back in manual mode and the data streamed via the PCM interface is 9 bits. In the automatic mode, since the 9-bit data readback is from two registers, the LSB register isn't guaranteed to be synchronous with the MSB register and can result in higher noise in automatic mode.

The lowest measured PVDD measurement result is read back through the [LOWEST_PVDD_DATA_MSB](#) and [LOWEST_PVDD_DATA_LSB](#) bit fields. These bit fields both automatically clear and are reset to the value of the current measurement result immediately after LSB readback is completed.

The PVDD channel also provides an optional lowpass IIR filter with a programmable bandwidth that scales relative to the measurement ADC sample rate. The filter is enabled with the [MEAS_ADC_PVDD_FILT_EN](#) bit and the bandwidth is set with the [MEAS_ADC_PVDD_FILT_COEFF](#) bit field.

Measurement ADC VBAT Channel

When the device is clocked, in the active state ($EN = 1$), the measurement ADC VBAT channel can be enabled. The VBAT channel is manually enabled by setting the [MEAS_ADC_VBAT_EN](#) bit to 1 and must be manually enabled for the DHT to operate. When the channel is enabled, it continuously measures and reports the VBAT supply voltage level over the range of 2.5V to 5.5V.

The output of the measurement ADC VBAT channel can be read back through the [MEAS_ADC_VBAT_DATA](#) bit field. By default ([MEAS_ADC_VBAT_RD_MODE](#) = 0), the VBAT readback value is automatically updated after each conversion is completed. Setting [MEAS_ADC_VBAT_RD_MODE](#) to 1 places VBAT readback into manual mode. In manual mode, the readback result is updated when a 1 is written to the [MEAS_ADC_VBAT_RD_UPD](#) bit field. The ADC VBAT channel data read back in manual mode and the data streamed through the PCM interface is 9 bits. In the automatic mode, since the 9-bit data readback is from two registers, the LSB register isn't guaranteed to be synchronous with the MSB register and can result in higher noise in automatic mode.

The lowest measured VBAT measurement result is read back through the [LOWEST_VBAT_DATA_MSB](#) and [LOWEST_VBAT_DATA_LSB](#) bit fields. These bit fields both automatically clear and are reset to the value of the current measurement result immediately after LSB readback is completed.

The VBAT channel also provides an optional lowpass IIR filter with a programmable bandwidth that scales relative to the measurement ADC sample rate. The filter is enabled with the [MEAS_ADC_VBAT_FILT_EN](#) bit and the bandwidth is set with the [MEAS_ADC_VBAT_FILT_COEFF](#) bit field.

Measurement ADC VDDH Channel

When the device is clocked, and in the active state (*EN* = 1), the measurement ADC VDDH channel can be enabled. The VDDH channel is manually enabled by setting the [MEAS_ADC_VDDH_EN](#) bit to 1. When the channel is enabled, it continuously measures and reports the VDDH supply voltage level over the range of 2.5V to 28V.

The output of the measurement ADC VDDH channel can be read back through the [MEAS_ADC_VDDH_DATA](#) bit field, and is routed to the BPE. By default ([MEAS_ADC_VDDH_RD_MODE](#) = 0), the VDDH readback value is automatically updated after each conversion is completed. Setting [MEAS_ADC_VDDH_RD_MODE](#) to 1 places VDDH readback into manual mode. In manual mode, the readback result is updated when a 1 is written to the [MEAS_ADC_VDDH_RD_UPD](#) bit field. The ADC VDDH channel data read back in manual mode and the data streamed via the PCM interface is 9 bits. In the automatic mode, since the 9-bit data readback is from two registers, the LSB register isn't guaranteed to be synchronous with the MSB register and can result in higher noise in automatic mode.

The lowest measured VDDH measurement result is read back through the [LOWEST_VDDH_DATA_MSB](#) and [LOWEST_PVDD_DATA_LSB](#) bit fields. These bit fields both automatically clear and are reset to the value of the current measurement result immediately after the LSB readback is completed.

The VDDH channel also provides an optional lowpass IIR filter with a programmable bandwidth that scales relative to the measurement ADC sample rate. The filter is enabled with the [MEAS_ADC_VDDH_FILT_EN](#) bit and the bandwidth is set with the [MEAS_ADC_VDDH_FILT_COEFF](#) bit field.

Clock and Data Monitors

The device provides input data and external clock monitors that detect host and system-level faults. The data monitor detects persistent stuck and high amplitude input signals, while the clock monitor detects external clock failures and invalid clock configurations. Upon fault detection, these monitors automatically place the device into software shutdown to stop glitches and unwanted signals at the amplifier output and speaker load.

Input Data Monitor

The device provides an optional input data monitor that is enabled by setting [DMON_MAG_EN](#) to 1 for the data magnitude monitor or [DMON_STUCK_EN](#) to 1 (for the data stuck monitor). Once the data monitor is enabled, it actively monitors the selected input data (from DIN) to the speaker amplifier path anytime the device exits software shutdown (*EN* = 1) and the amplifier is enabled (*SPK_EN* = 1). When the tone generator is enabled, the data monitor is automatically disabled.

When active, the block monitors the selected input data for the enabled data error types (data magnitude, data stuck, or both). The [DMON_DURATION](#) bit field selects the duration that a data stuck or magnitude error must persist for before a data error is detected. Once a data error is detected, the data monitor automatically places the device into software shutdown (sets *EN* to 0) and generates a data monitor error interrupt ([DMON_ERR_*](#)).

A data stuck error is detected if the input signal repeats a fixed value with a magnitude (positive or negative) that is beyond the data stuck threshold ([DMON_STUCK_THRES](#)) for longer than the data error duration (set by [DMON_DURATION](#)) if the input signal repeats a fixed value for any duration with a magnitude that is within the data stuck threshold limits (such as a zero or near zero code), no data stuck error is detected.

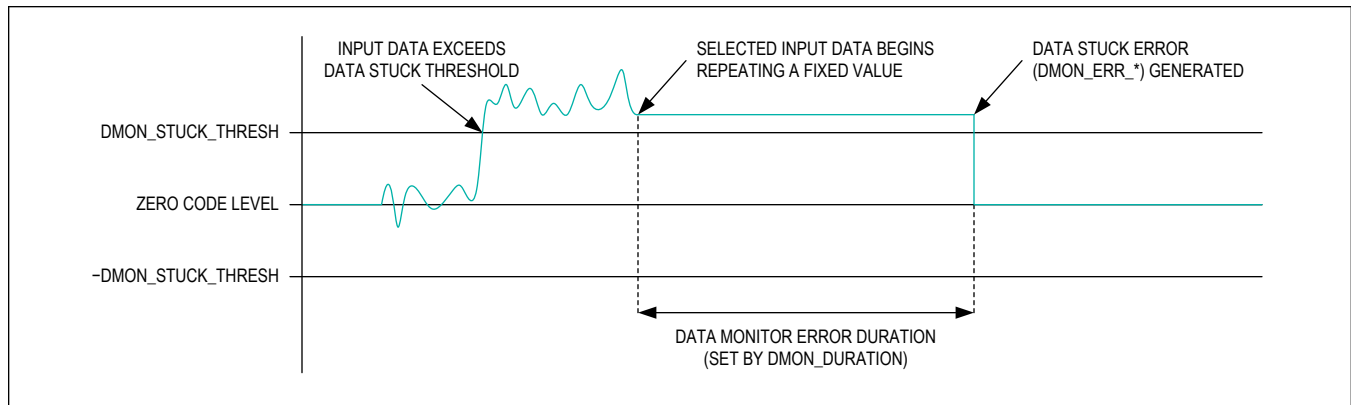

Figure 26. Data Monitor Error Generation due to Input Data Stuck Error Detection

A data magnitude error is detected if the input signal magnitude (positive or negative) is beyond the data magnitude threshold (set by [DMON_MAG_THRES](#)) for longer than the data error duration (set by [DMON_DURATION](#)).

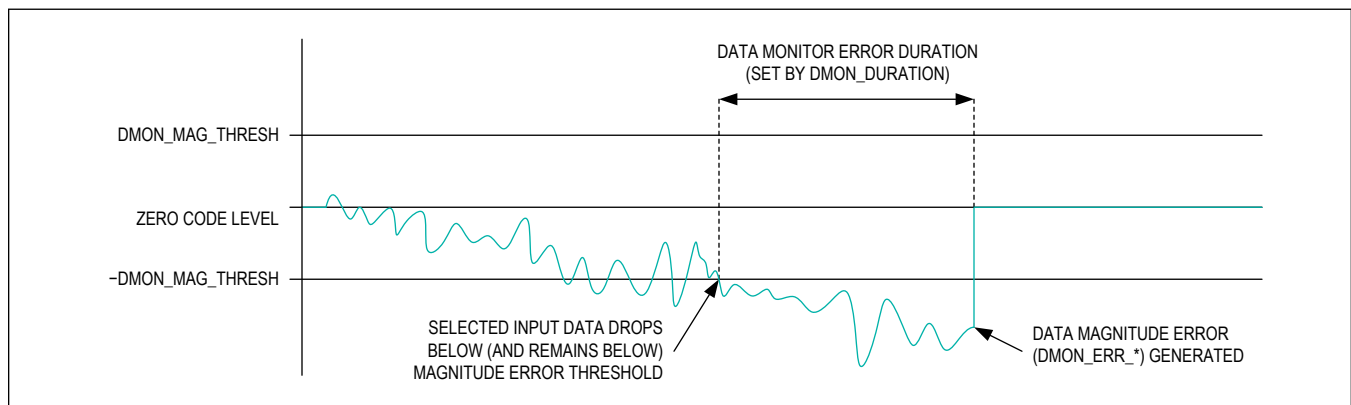

Figure 27. Monitor Error Generation due to Input Data Magnitude Error Detection

Clock Monitor

The device provides a clock monitor that is enabled by setting [CMON_EN](#) to 1. Once enabled, it actively monitors the input BCLK and LRCLK anytime the device exits software shutdown ($EN = 1$). When the tone generator is enabled, the clock monitor is automatically disabled. When active, the clock monitor detects clock activity, clock frequency, and frame timing (clock ratio). If faults are detected, the clock monitor automatically places the device into software shutdown and generates a clock error interrupt ([CLK_ERR_*](#)).

The clock monitor operates in automatic mode when [CMON_AUTORESTART_EN](#) = 1 and manual mode when [CMON_AUTORESTART_EN](#) = 0. In automatic mode, when a clock error places the device into software shutdown the global enable bit (EN) is not changed (remains 1), and the device automatically recovers from all clock errors. In automatic mode, both clock error ([CLK_ERR_*](#)) and clock recovery ([CLK_RECOVER_*](#)) interrupts are generated in pairs (a clock recovery interrupt is not possible until after a clock error has occurred).

In manual mode, when a clock error places the device into software shutdown, the global enable bit (EN) is set to 0. Clock recovery ([CLK_RECOVER_*](#)) interrupts are never generated in manual mode, and the device remains in software shutdown until the host sets EN back to 1. Once the device is re-enabled (EN set to 1), the clock monitor is active and detects any new (or persisting) clock errors. If a clock error is detected, the device returns to software shutdown ($EN = 0$), and a new clock error interrupt ([CLK_ERR_*](#)) is generated.

Clock errors are fault conditions, and audible glitches may occur on clock monitor-based transitions into and out of software shutdown. When the clock monitor is enabled, no false clock error or clock recovery interrupts are generated

when the host software transitions the device normally into and out of software shutdown.

The clock monitor is enabled by default, and it is highly recommended to keep the block enabled to allow the speaker monitor to function correctly in absence of BCLK and LRCLK.

Clock Activity and Frequency Detection

When the clock monitor is enabled, the bit clock (BCLK) and frame clock (LRCLK) frequencies are monitored. The expected LRCLK frequency is equal to the PCM sample rate ([PCM_SR](#)). The expected BCLK frequency is based on the BCLK to LRCLK ratio ([PCM_BSEL](#)) relative to the PCM sample rate ([PCM_SR](#)).

The current frequency of each clock is measured relative to (and once per interval of) the programmed frame period (as set by [PCM_SR](#)). A clock frequency error is detected when the measured clock frequencies differ from programmed clock frequencies (faster or slower) by more than the frequency error threshold (45% typical). If either clock stops high or low, the frequency measurement result allows the detection of the clock stop event.

The [CMON_ERRTOL](#) bit field sets the clock frequency error tolerance. The tolerance is the required number of consecutive frame clock periods ([PCM_SR](#)) with an incorrect clock frequency before a clock error is generated. If the error persists for the selected number of frame periods, a clock error interrupt ([CLK_ERR_*](#)) is generated, and the device is placed into software shutdown.

In automatic mode, the [CMON_ERRTOL](#) bit field also sets the number of consecutive frame clock periods with no clock frequency errors (LRCLK or BCLK) that are required for automatic restart to occur. Once the selected number of consecutive error-free frames are detected, a clock recovery interrupt ([CLK_RECOVER_*](#)) is generated and the device automatically exits software shutdown.

In manual mode, no clock recovery interrupts are generated. The clock monitor remains disabled, and the device remains in software shutdown until the host software sets [EN](#) back to 1.

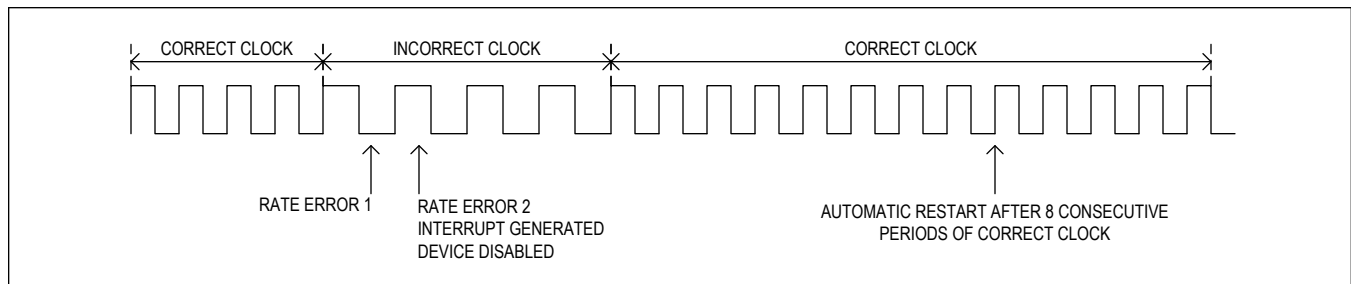

Figure 28. Clock Monitor LRCLK Rate Error Example with [CMON_ERRTOL](#) = 0x1

Clock Frame Error Detection

When the clock monitor is enabled, the bit clock (BCLK) to frame clock (LRCLK) ratio is monitored. The clock monitor counts the number of BCLK periods per frame (LRCLK period) and then compares the count to the configured clock ratio ([PCM_BSEL](#)). In addition, in I²S and left-justified (LJ) modes the clock monitor verifies the LRCLK duty cycle by checking that the number of BCLK periods per channel is equal. In TDM mode, data transport is synchronized to the active frame clock (LRCLK) edge, so no duty cycle restrictions are enforced.

A frame error is detected in each frame where the monitored clock ratio (and duty cycle in I²S and LJ modes) differs from the configured settings. The [CMON_BSELTOL](#) bit field sets the number of consecutive frames with frame errors that are required before a clock error interrupt is generated ([CLK_ERR_*](#)) and the device is placed into software shutdown.

In automatic mode, the [CMON_BSELTOL](#) bit field also sets the number of consecutive frames with no frame errors that are required for automatic restart to occur. Once the selected number of consecutive error-free frames are detected, a clock recover interrupt ([CLK_RECOVER_*](#)) is generated and the device automatically exits software shutdown.

In manual mode, no clock recovery interrupts are generated. The clock monitor remains disabled, and the device remains in software shutdown until the host software sets [EN](#) back to 1.

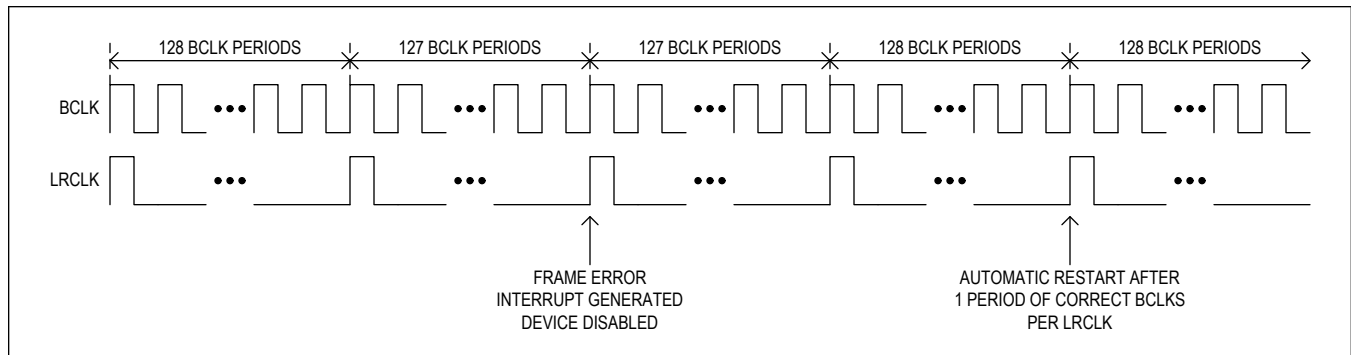

Figure 29. Clock Monitor Framing Error Example in TDM Mode with $PCM_BSEL = 0x6$ and $CMON_BSELTOL = 0x0$

Speaker Monitor

The speaker monitor is a circuit that is designed to protect the speaker against amplifier signals that could damage it. The speaker monitor is enabled by default and can be disabled by setting the [SPKMON_EN](#) bit to zero. The circuit monitors the amplifier's PWM signal and shuts down the amplifier output when the DC signal goes above a programmed speaker monitor threshold (set by [SPKMON_THRESH](#)). Additionally, the device also generates an [INT_SPKMON_ERR](#) interrupt. For the speaker monitor to operate, PCM clocks should be available.

Thermal Protection

When the device is active, the measurement ADC thermal channel is automatically enabled, and it monitors the die temperature to ensure that it does not exceed the configured thermal thresholds. Interrupt registers are provided so that the device can notify the host when the die temperature crosses either the thermal warning or thermal-shutdown threshold, or when thermal foldback starts and stops.

Thermal Warning and Thermal Shutdown Configuration

The device features two thermal-warning thresholds. The thermal-warning thresholds are configured by [THERMWARN1_THRESH\[6:0\]](#) and [THERMWARN2_THRESH\[6:0\]](#) bit fields and the thermal-shutdown threshold is configured by the [THERMSHDN_THRESH\[5:0\]](#) bit field. The thermal-warning2 threshold should always be set to a temperature higher than or equal to the thermal-warning1 temperature. Additionally, the thermal-warning2 threshold temperature should never be configured higher than the thermal shutdown threshold temperature minus hysteresis. When the die temperature is decreasing, hysteresis is applied to thermal-shutdown, thermal-warning1, and thermal-warning2 thresholds. The temperature hysteresis is configured with the [THERM_HYST](#) bit field.

Thermal Shutdown Recovery Configuration

The device thermal-shutdown recovery behavior is determined by the state of the [THERM_AUTORESTART_EN](#) bit. When the [THERM_AUTORESTART_EN](#) bit is set to 0, the thermal-shutdown recovery is in manual mode. In manual mode, when the die temperature exceeds the thermal-shutdown threshold an interrupt is generated and the amplifier output is automatically disabled. Once the die temperature drops below the thermal shutdown minus the hysteresis and thermal-warning2 threshold minus the hysteresis, the appropriate interrupts are generated to notify the host. In addition, once the die temperature drops below the thermal-warning2 threshold minus the hysteresis, the device is placed into software shutdown ([EN](#) is set to 0) and remains in that state until the host manually re-enables the device. When the [THERM_AUTORESTART_EN](#) bit is set to 1, the thermal-shutdown recovery is in automatic mode. In automatic mode, when the die temperature exceeds the thermal-shutdown threshold an interrupt is generated and the amplifier is automatically disabled. Once the die temperature drops below the thermal-shutdown threshold minus the hysteresis, an interrupt is generated but the amplifier remains disabled. When the temperature drops below the thermal-warning2 threshold minus the hysteresis, another interrupt is generated and (unlike manual mode) the amplifier is then automatically re-enabled.

Thermal Foldback

The device features thermal foldback to allow for a smoother audio response to high-temperature events. Thermal

foldback is enabled by setting the [THERMFB_EN](#) bit to 1. The device provides two thermal-warning thresholds that are configured by [THERMWARN1_THRESH\[6:0\]](#) and [THERMWARN2_THRESH\[6:0\]](#) bit fields. They should be set such that the thermal-warning2 threshold temperature is higher than or equal to the thermal-warning1 threshold temperature. Additionally, the thermal-warning2 threshold temperature should never be configured higher than the thermal-shutdown threshold temperature minus hysteresis.

Once enabled, when the die temperature exceeds the configured thermal-warning1 threshold, the thermal foldback begins, interrupts are generated ([THERMFB_BGN *](#) and [THERMWARN1_BGN *](#)) and attenuation is applied to the speaker amplifier path. The slope of the thermal foldback attenuation is programmed with the [THERMFB_SLOPE1](#) bit field.

If the die temperature continues to increase and exceeds the configured thermal-warning2 threshold, an interrupt ([THERMWARN2_BGN *](#)) is generated and attenuation is continued to be applied to the speaker amplifier path. The slope of the attenuation applied to the speaker amplifier path is now programmed with the [THERMFB_SLOPE2](#) bit field. As the die temperature increases, the level of attenuation also increases proportionally up to a maximum level of -12dB (unless the thermal-shutdown threshold is exceeded first). When thermal foldback is active, the attack time for a gain change can be a maximum of 2 samples. Additionally, there is a sample delay in the signal path attenuation due to the group delay of the amplifier.

When the die temperature starts to decrease and drops below the thermal-warning2 threshold minus the programmed hysteresis level and remains there for longer than the programmed hold time (set with the [THERMFB_HOLD](#) bit field), the attenuation starts to release and an interrupt ([THERMWARN2_END *](#)) is generated. If the die temperature continues to reduce and drops below the thermal-warning1 threshold temperature minus the programmed hysteresis level, thermal foldback ends and interrupts ([THERMFB_END *](#) and [THERMWARN1_END *](#)) are generated. The attenuation release rate (for decreasing temperature) is programmable and is configured with the [THERMFB_RLS](#) bit field.

Tone Generator

The device includes a tone generator which when enabled (using the [TONE_EN](#) bit field) replaces the PCM interface as the input source to the speaker playback path. When the tone generator is enabled, both it and the speaker playback path operates without the need for any external clocks.

The tone generator output is configured to generate sine wave or DC tones (using the [TONE_CONFIG](#) bit field).

The tone generator can create sine waves with either a 1kHz fixed frequency or a variable sample rate-dependent frequency. When a sample rate-based sinewave output is selected, the tone generator output frequency is set by the playback sample rate setting ([PCM_SR](#)) divided by the selected ratio (as set by [TONE_CONFIG](#)). For the playback sample rate of 44.1kHz and its multiples, the tone generator output frequency can vary by up to 9%. The tone generator supports all available sample rate settings ([PCM_SR](#)). The amplitude of the output sine wave relative to full-scale is selected with the [TONE_AMPLITUDE](#) bit field.

The tone generator can output either a fixed or a programmable DC output level (as set by [TONE_CONFIG](#)). Fixed DC output levels of zero code, positive half-scale, and negative half-scale are provided for quick configuration. If the programmable DC output level is selected ([TONE_CONFIG](#)), the DC level is configured as a signed two's complement value with the [TONE_DC](#) bit field.

Pink Noise Generator

The device includes a pink noise generator which when enabled (using the [PINK_NOISE_EN](#) bit field) replaces the PCM interface as the input source to the speaker playback path. The pink noise generator and the tone generator cannot be enabled at the same time. When the pink noise generator is enabled, both it and the speaker playback path operate without the need for any external clocks. The output level of the generator is fixed, so the amplifier gain and speaker volume must be used to adjust the level.

Interchip Communication

The device features an interchip communication (ICC) interface that uses a shared data bus to facilitate synchronized speaker amplifier path attenuation adjustments across groups of devices. Depending on the configuration, the ICC interface can synchronize the brownout prevention engine (BPE), DHT, and thermal foldback. Each device receives the data of the other grouped devices and reacts accordingly.

ICC Operation and Data Format

The bidirectional ICC bus is used to synchronize the responses of grouped devices. To create the ICC bus, the ICC interface pins of each device are externally connected (whether or not the devices are in the same group). The ICC bus operates with the same clock sources and data format configuration as the PCM interface data input (DIN), and can support a maximum of 16 channels. For a given valid PCM interface configuration, the number of available ICC data channels per frame is calculated as follows (based on the [PCM_CHANSZ](#), [PCM_BSEL](#), and [PCM_FORMAT](#) settings):

$$\text{Number of Available Data Input Channels} = \text{BCLK to LRCLK Ratio} / \text{Channel Length}$$

The ICC interface is disabled when both the ICC data transmit output ([ICC_TX_EN](#)) and the ICC data link ([ICC_LINK_EN](#)) is disabled. To enable the ICC interface, both [ICC_TX_EN](#) and [ICC_LINK_EN](#) must be set to 1. It is illegal to set these controls to different values, and both must always be set to the same state (either enabled or disabled). Once the ICC link and data transmit are enabled, the ICC data output channel is assigned with the [ICC_TX_DEST](#) bit field. The ICC pin is Hi-Z during all other data channels and can be configured (with the [ICC_RX_CHn_EN](#) bits) to accept data from the output data channels of grouped devices.

The transmitted ICC data is always the same size as the configured PCM data input word size (as set by [PCM_CHANSZ](#)). When a 16-bit data word is selected, the ICC data word is not long enough to synchronize BPE, DHT, and thermal foldback. In this case, the [ICC_DATA_SEL](#) bit is used to choose whether the DHT function or thermal foldback function is synchronized in addition to the BPE state. When a 24-bit or 32-bit data word size is selected, ICC can synchronize BPE, DHT, and thermal foldback across a given group. In these cases, the [ICC_DATA_SEL](#) bit has no effect. Active ICC data channels always contain ICC data words followed by the zero-padding bit up to the ICC data channel length (which is equal to the PCM input data channel length). If BPE, DHT, or thermal foldback is disabled for any given group, then the transmitted ICC data for the disabled function(s) is always zero code.

Multiamplifier Grouping

The ICC interface allows multiple devices to be grouped so that BPE, DHT, and thermal foldback behavior can be synchronized. The receive channel enables ([ICC_RX_CHn_EN](#)) are used to define groups. A given device monitors all selected channels (when [ICC_RX_CHn_EN](#) = 1, and n denotes the channel number) on the ICC data bus. The configured set of receive channels must also include the assigned transmit channel (as set by [ICC_TX_DEST](#)) for any given device. Each device in a given group must have identical settings for all ICC receive channel enables ([ICC_RX_CHn_EN](#)). Furthermore, all devices in the same group must have identical DHT, thermal protection, and thermal foldback settings to achieve a synchronized response across the group. The behavior of a group as a whole is undefined if any given device in a group has different settings.

The ICC bus can support a maximum of 16 data channels. The minimum size of a group is two devices, and as a result, the maximum number of concurrent groups on a single ICC bus is eight. A group can contain as many as 16 devices, but then only a single group is possible on a single ICC bus.

ICC Multigroup Example

Consider a system design that includes four devices that require DHT synchronization, and that two distinct groups of two devices each (with different DHT settings) must share a single ICC bus. The PCM interface (and thus the ICC bus) is configured in TDM mode 1 with four 16-bit data channels available. One possible configuration (among many) is to assign devices 1 and 3 to the first group (denoted group A) and to assign devices 2 and 4 to a second group (denoted group B).

To configure group A, both devices 1 and 3 are set to monitor channels 0 and 2 by programming [ICC_RX_CH0_EN](#) = 1 and [ICC_RX_CH2_EN](#) = 1 on both devices (all other ICC receive bit fields are 0). Device 1 transmits on channel 0 ([ICC_TX_DEST](#) = 0x0) and device 3 transmits on channel 2 ([ICC_TX_DEST](#) = 0x2).

To configure group B, both devices 2 and 4 are set to monitor channels 1 and 3 by programming [ICC_RX_CH1_EN](#) = 1 and [ICC_RX_CH3_EN](#) = 1 on both devices (all other ICC receive bit fields are 0). Device 2 transmits on channel 1 ([ICC_TX_DEST](#) = 0x1) and device 4 transmits on channel 3 ([ICC_TX_DEST](#) = 0x3).

Since the ICC channel length and data word size is limited to 16 bits, the [ICC_DATA_SEL](#) bit field in all 4 devices must be set to 0 to select DHT target attenuation synchronization. Finally, on all 4 devices set [ICC_LINK_EN](#) = 1 and [ICC_TX_EN](#) = 1 to enable the ICC interfaces.

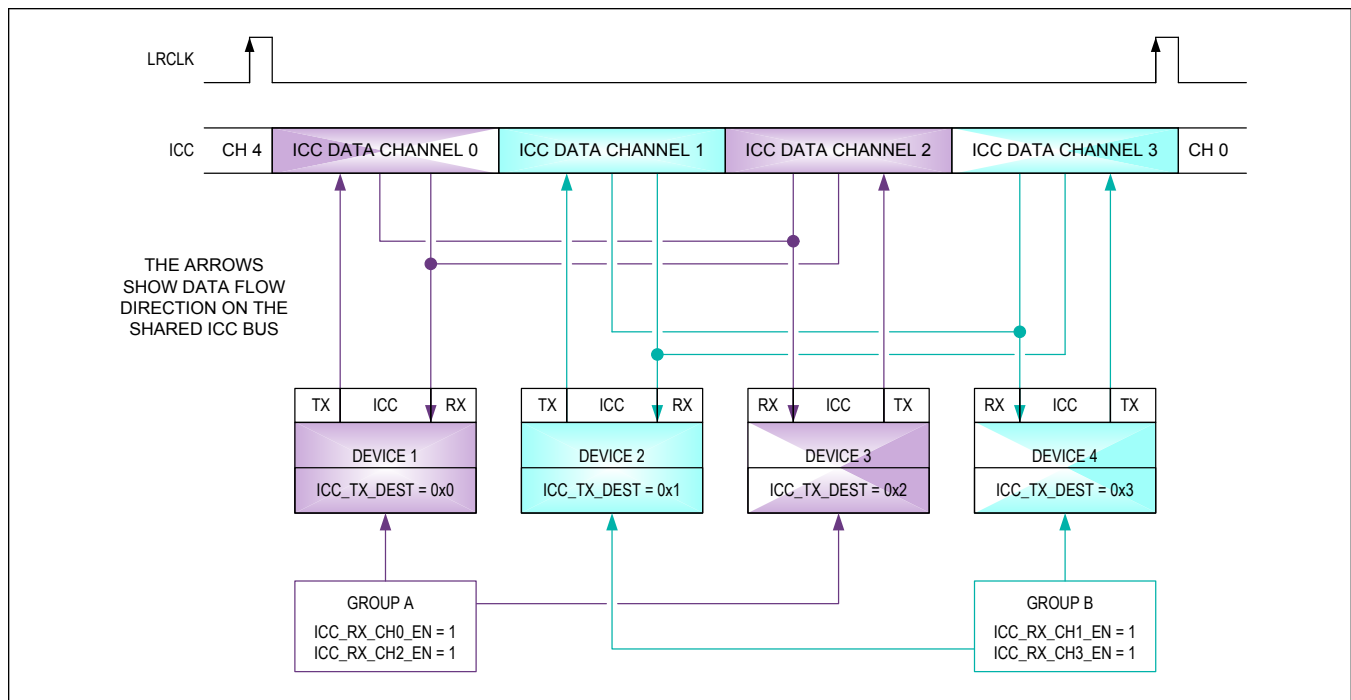

Figure 30. ICC Multigroup Example with Two Groups and Four Total Devices

ICC Over PCM Output (DOUT)

In non-HDI PCB layouts, an ICC pin may not be available for routing due to the location of the pin on an internal bump. In such systems, ICC functionality can be enabled by using the DOUT pin and the shared PCM bus. ICC over DOUT is enabled when [ICC_OVER_DOUT_EN](#) and [ICC_LINK_EN](#) are both set to 1. When it is enabled, the DOUT pin carries all supported PCM data output types as well as ICC data.

The device uses information in the PCM_ICC_SLOT bit field to select the starting location of the ICC to transmit data and uses [ICC_RX_CHn_EN](#) to identify the channels to monitor data from other devices in its group. In TDM format mode with 24-bit or 32-bit PCM data widths, each PCM_ICC_SLOT setting selects 3 PCM 8-bit slots to transmit all 23 bits of ICC data.

In TDM format mode with 16-bit PCM data width, all 23 bits of ICC data can be interleaved by setting [ICC_INTERLEAVE_MODE](#) to 1. In this case, BPE and DHT ICC data is sent in the first frame, and BPE and Thermal ICC data is sent in the next frame. The BPE and DHT ICC data frame is indicated by setting MSB to 0 in the ICC transmit data slot, whereas BPE and thermal ICC data frame is indicated by setting MSB to 1 in the ICC transmit data slot. If [ICC_DATA_SEL](#) is set to select either BPE+DHT or BPE+Therm data to be sent on ICC, it is not required to use interleave mode.

In I²S/LJ format mode with 24-bit or 32-bit PCM data widths and IV_{SENSE} disabled and ICC transmit data from each device on the bus will occupy each channel. With 16-bit PCM data width, ICC over DOUT with all 23 bits of ICC data, works in ICC interleave mode ([ICC_INTERLEAVE_MODE](#) to be set to 1). In interleave mode, BPE and DHT ICC data frame are indicated by setting MSB to 0 in the ICC transmit data slot, whereas BPE and thermal ICC data frame is indicated by setting MSB to 1 in the ICC transmit data slot. If [ICC_DATA_SEL](#) is set to select either BPE+DHT or BPE+Therm data to be sent on ICC, it is not required to use interleave mode.

In I²S/LJ format mode with IV_{SENSE} enabled, ICC over DOUT works with 32-bit PCM data width only and requires [ICC_INTERLEAVE_MODE](#) to be set to 1. Since ICC data shares the slot with IV data, PCM_ICC_SLOT must be set to the same setting as [PCM_VMON_SLOT](#). In interleave mode, BPE and DHT ICC data frame are indicated by setting MSB to 0 in the ICC transmit data slot, whereas BPE and thermal ICC data frame is indicated by setting MSB to 1 in the ICC transmit data slot.

I²C Serial Interface

Peripheral Address

The peripheral address is defined as the seven most significant bits (MSBs) followed by the read/write bit. The seven most significant bits are programmable through the ADDR1 and ADDR2 connection as shown in [Table 11](#). The device does not communicate if ADDR1 and ADDR2 are floating. Setting the read/write bit to 1 configures the device for read mode. Setting the read/write bit to 0 configures the device for write mode. The address is the first byte of information sent to the IC after the START condition.

Table 11. I²C Peripheral Address

ADDR1 CONNECTION	ADDR2 CONNECTION	I ² C PERIPHERAL ADDRESS (BINARY)	I ² C WRITE ADDRESS (BINARY)	I ² C READ ADDRESS (BINARY)
Connected to DVDD	Connected to AGND	0111000x	01110000	01110001
Connected to DGND	Connected to AGND	0111001x	01110010	01110011
Connected to SDA	Connected to AGND	0111010x	01110100	01110101
Connected to SCL	Connected to AGND	0111011x	01110110	01110111
Connected to DVDD	Connected to DVDD	0111100x	01111000	01111001
Connected to DGND	Connected to DVDD	0111101x	01111010	01111011
Connected to SDA	Connected to DVDD	0111110x	01111100	01111101
Connected to SCL	Connected to DVDD	0111111x	01111110	01111111

The IC features an I²C/SMBus-compatible, 2-wire serial interface consisting of a serial data line (SDA) and a serial clock line (SCL). SDA and SCL facilitate communication between the IC and the controller at clock rates up to 1MHz. [Figure 31](#) shows the 2-wire interface timing diagram. The controller generates SCL and initiates a data transfer on the bus. The controller device writes data to the IC by transmitting the proper peripheral address followed by two register address bytes (the most significant byte first) and then the data word. Each transmit sequence is framed by a START (S) or REPEATED START (Sr) condition and a STOP (P) condition. Each word transmitted to the IC is 8 bits long and is followed by an acknowledge clock pulse. A controller reading data from the IC transmits the proper peripheral address followed by a series of nine SCL pulses. The IC transmits data on SDA in sync with the controller-generated SCL pulses. The controller acknowledges receipt of each byte of data. Each read sequence is framed by a START (S) or REPEATED START (Sr) condition, a not acknowledge, and a STOP (P) condition. SDA operates as both an input and an open-drain output. A pullup resistor, typically greater than 500Ω, is required on SDA. SCL operates only as an input. A pullup resistor, typically greater than 500Ω, is required on SCL if there are multiple controllers on the bus, or if the single controller has an open-drain SCL output. Series resistors in line with SDA and SCL are optional. Series resistors protect the digital inputs of the IC from high voltage spikes on the bus lines, and minimize crosstalk and undershoot of the bus signals.

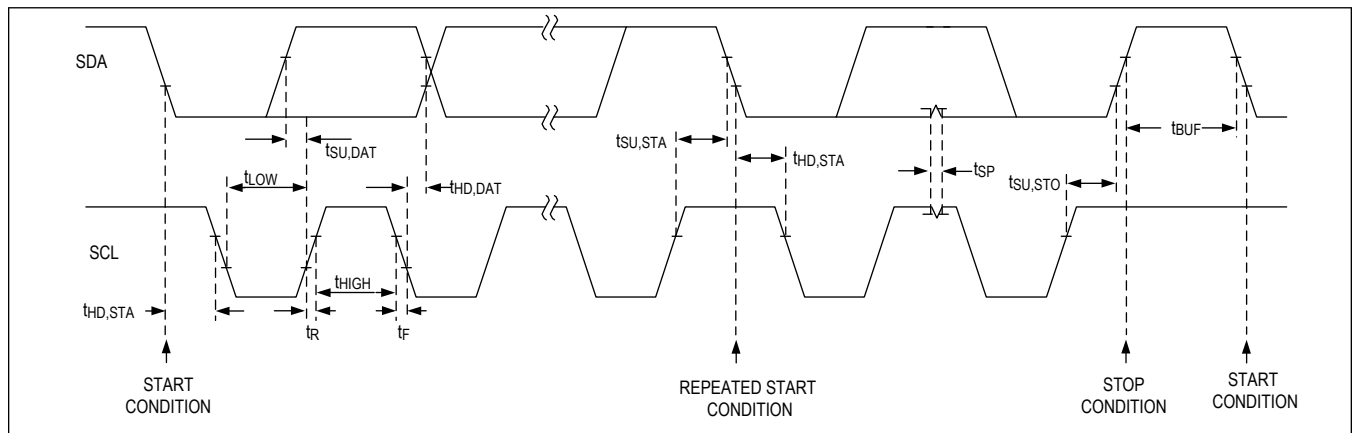

Figure 31. I²C Interface Timing Diagram

Bit Transfer

One data bit is transferred during each SCL cycle. The data on SDA must remain stable during the high period of the SCL pulse. Changes in SDA, while SCL is high, are control signals (see the [START and STOP Conditions](#) section).

START and STOP Conditions

SDA and SCL idle high when the bus is not in use. A controller initiates communication by issuing a START condition. A START condition is a high-to-low transition on SDA with SCL high. A STOP condition is a low-to-high transition on SDA while SCL is high. A START condition from the controller signals the beginning of a transmission to the IC. The controller terminates transmission, and frees the bus, by issuing a STOP condition. The bus remains active if a REPEATED START condition is generated instead of a STOP condition.

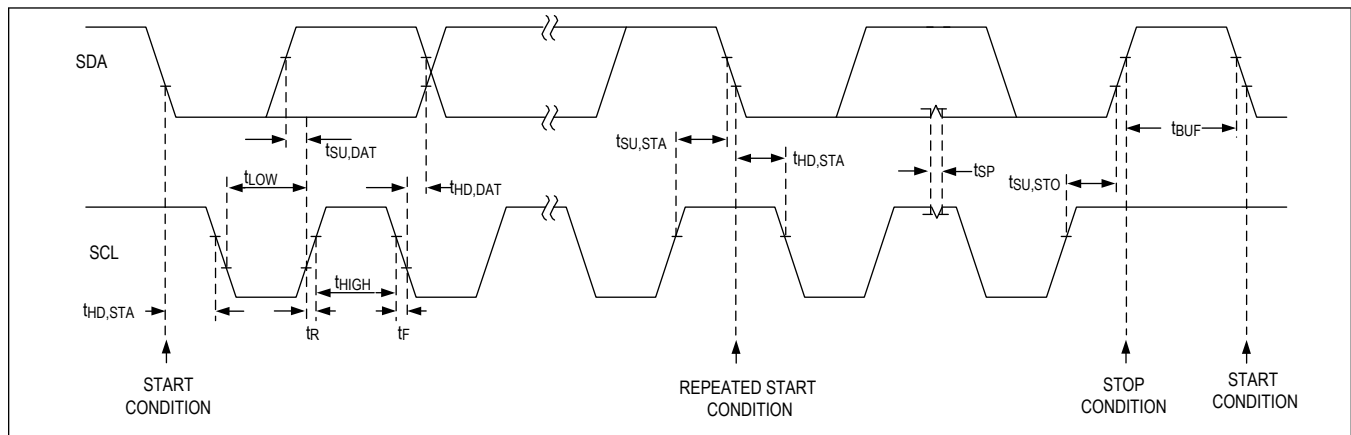

Figure 32. I^2C START, STOP, and REPEATED START Conditions

Early STOP Conditions

The IC recognizes a STOP condition at any point during data transmission except if the STOP condition occurs in the same high pulse as a START condition. For proper operation, do not send a STOP condition during the same SCL high pulse as the START condition.

Acknowledge

The acknowledge bit (ACK) is a clocked 9th bit that the IC uses to handshake receipt each byte of data when in write mode. The IC pulls down SDA during the entire controller-generated 9th clock pulse if the previous byte is successfully received. Monitoring ACK allows for the detection of unsuccessful data transfers. An unsuccessful data transfer occurs if a receiving device is busy or if a system fault has occurred. In the event of an unsuccessful data transfer, the bus controller retries communication. The controller pulls down SDA during the 9th clock cycle to acknowledge receipt of data when the IC is in read mode. An acknowledge is sent by the controller after each read byte to allow data transfer to continue. A not-acknowledge is sent when the controller reads the final byte of data from the IC, followed by a STOP condition.

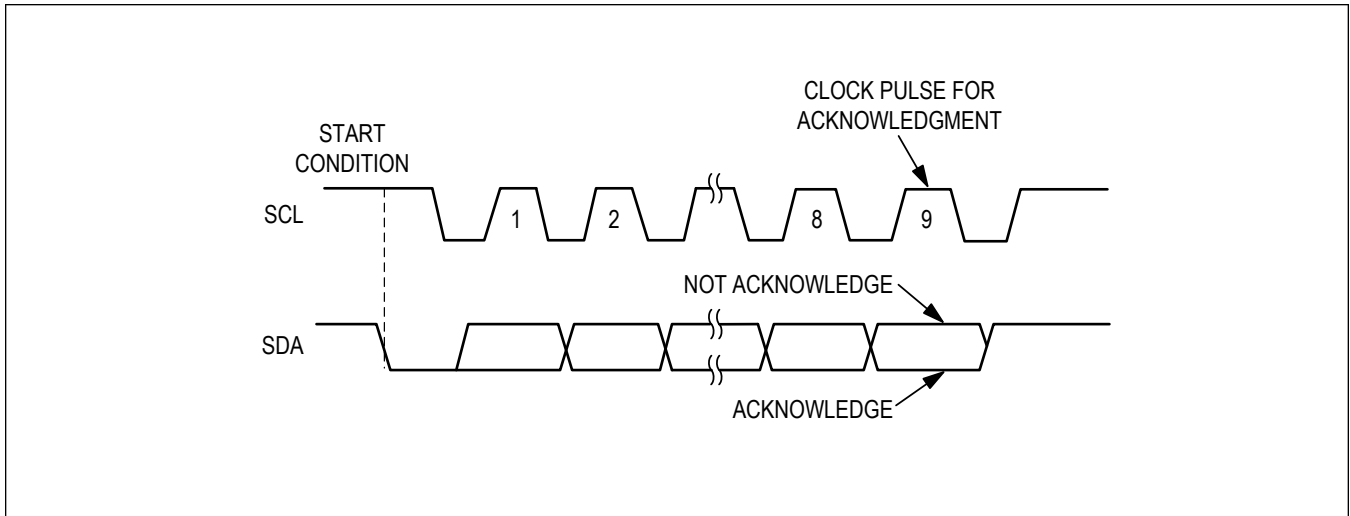

Figure 33. I^2C Acknowledge

Write Data Format

A write to the IC includes the transmission of a START condition, the peripheral address with the R/\overline{W} bit set to 0, two bytes of data to configure the internal register address pointer, one or more bytes of data, and a STOP condition.

The peripheral address with the R/\overline{W} bit set to 0 indicates that the controller intends to write data to the IC. The IC acknowledges receipt of the address byte during the controller-generated 9th SCL pulse.

The second and third bytes transmitted from the controller configure the ICs internal register address pointer. The pointer tells the IC where to write the next byte of data. An acknowledge pulse is sent by the IC upon receipt of the address pointer data.

The third byte sent to the IC contains the data that is written to the chosen register. An acknowledge pulse from the IC signals receipt of the data byte. The address pointer auto increments to the next register address after each received data byte. This auto-increment feature allows a controller to write to sequential registers within one continuous frame. The controller signals the end of transmission by issuing a STOP condition.

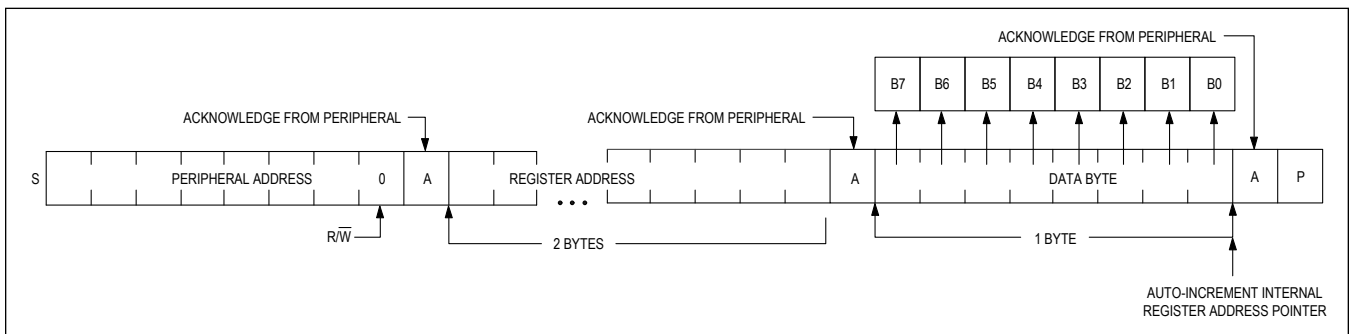

Figure 34. I^2C Writing One Byte of Data to the Peripheral

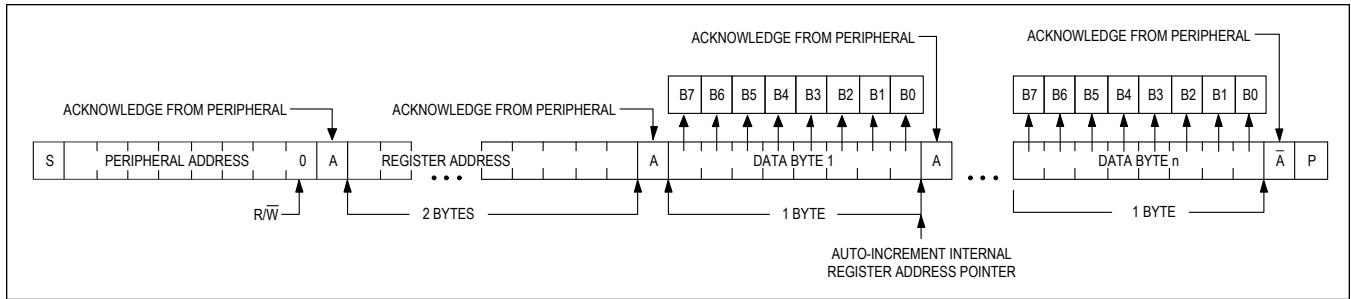

Figure 35. I²C Writing n-Bytes of Data to the Peripheral

Read Data Format

The I²C register address pointer must be preset to a specific target register address before a read command is issued. The controller presets the peripheral register address pointer by first sending the device's peripheral address with the R/\bar{W} bit set to 0 (write command) followed by two commands containing the target register address for the address pointer.

A REPEATED START condition is then sent followed by the read command (peripheral address with the R/\bar{W} bit set to 1). This begins a read command with the internal register address pointer set to the target register address. The first byte transmitted from the device contains the contents of the register that the address pointer is set to. Transmitted data is valid on the rising edge of SCL. The controller acknowledges (ACK) receipt of each read byte during the acknowledge clock pulse. The address pointer then auto-increments after each acknowledged read data byte. This auto-increment feature allows multiple registers to be read sequentially within one continuous frame.

The controller must issue an acknowledge (ACK) for all correctly received bytes except the last byte. To terminate the read operation, the final byte must be followed by a not acknowledge (NACK) from the controller and then a STOP condition. A not-acknowledge (NACK) followed by a STOP condition can be issued after any number of read data bytes.

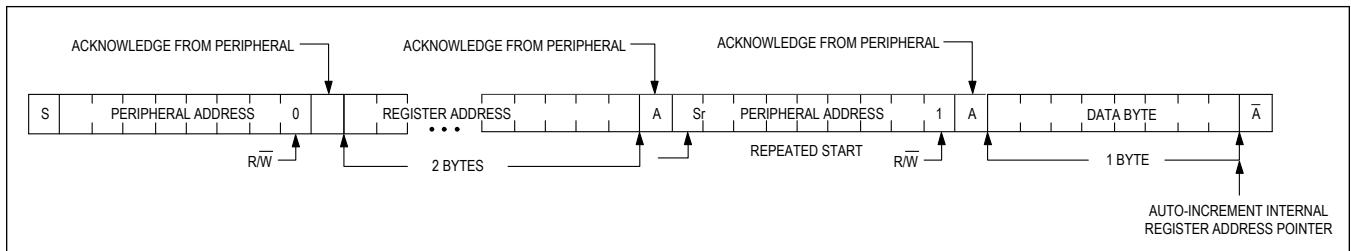

Figure 36. I²C Controller Reading One Byte of Data from the Peripheral

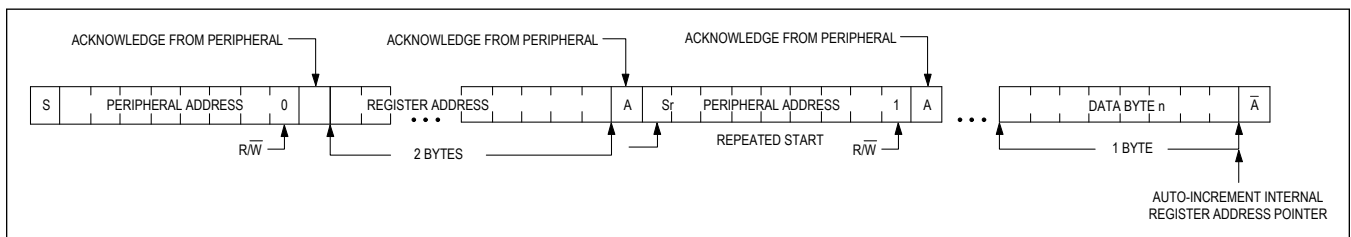

Figure 37. I²C Controller Reading n-Bytes of Data from the Peripheral

I²C Register Map

Control Bit Field Types and Write Access Restrictions

The device control bit fields fall into one of three basic types: read, write, or read and write. There are no read restrictions, and any read-enabled bit field can be read back anytime the I²C control interface is active. There are however write restrictions, and every write-enabled bit field falls into one of two write access subtypes.

The first write access subtype is dynamic. Dynamic bit fields effectively have no write access restrictions and can be safely changed (written) in any device state where the I²C control interface is active. The second bit field access subtype is restricted. Restricted bit fields should only be changed (written) when the related functional block (as shown in [Table 12](#)) is powered down.

If the write access is restricted to the global enable (restrictions EN and ENL), then the restricted bit field should only be changed (written) when the device is in software shutdown. As a form of system protection, write access to some critical global enable restricted bit fields (ENL) is locked out by the hardware when the device is not in the software-shutdown state. Attempting to change (write to) these locked restricted bit fields when the device is not in the software-shutdown state has no effect (read-access is still allowed).

The bit field type and write access subtype are provided for every bit field in the detailed register description tables. For all bit fields with the restricted subtype, the dependency is also denoted in the "RES" column.

[Table 12](#) provides a detailed description of all device register types, access subtypes, and restriction dependencies that are used by this device. The write access restrictions describe the specific device condition(s) that should be met (and the corresponding bit field settings) before the system attempts to change (write to) bit fields with that restriction type.

Table 12. Control Bit Types and Write Access Restrictions

BIT FIELD TYPE	WRITE ACCESS	WRITE ACCESS RESTRICTIONS		"RES" SYMBOL
		DESCRIPTION	CONDITION	
Read	Read Only	—	—	—
Write or Read/Write	Dynamic	—	—	—
	Restricted	Device in Software Shutdown	EN = 0	EN
		Write Access Locked Out by Hardware Unless the Device is in Software Shutdown	EN = 0	ENL
		Speaker Amplifier Output and Feedback Disabled	SPK_EN = 0 and SPK_FB_EN = 0	SPK
		Voltage and Current Sense ADCs Disabled	IVADC_V_EN = 0 and IVADC_I_EN = 0	IVS
		Thermal Foldback Disabled	THERMFB_EN = 0	TFB
		Noise Gate Disabled	NOISEGATE_EN = 0	NG
		Dynamic Headroom Tracking Disabled	DHT_EN = 0	DHT
		Brownout Protection Engine Disabled	BPE_EN = 0	BPE
		PCM Interface Data Input and Output Disabled	PCM_RX_EN = 0 and PCM_TX_EN = 0	PCM
		PCM Data Output Disabled	PCM_TX_EN = 0	TXEN
		IRQ Bus Output Disabled	IRQ_EN = 0	IRQ
Interchip Communication (ICC) Interface Disabled	ICC_LINK_EN = 0 and ICC_TX_EN = 0	ICC		

Register Map

Register Map

ADDRESS	NAME	MSB							LSB
Reset									
0x2000	Software Reset[7:0]	-	-	-	-	-	-	-	RST
Interrupts									
0x2001	Interrupt Raw 1[7:0]	THERM_SHDN_BGN_RAW	THERM_SHDN_END_RAW	THERM_WARN1_BGN_RAW	THERM_WARN1_END_RAW	THERMF_B_BGN_RAW	THERMF_B_END_RAW	OTP_FAIL_RAW	SPK_OVC_RAW
0x2002	Interrupt Raw 2[7:0]	THERM_WARN2_BGN_RAW	THERM_WARN2_END_RAW	INT_SPK_MON_ERR_RAW	INT_CLK_ERR_RAW	-	CLK_RECOVER_RAW	CLK_ERR_RAW	DMON_ERR_RAW
0x2003	Interrupt Raw 3[7:0]	AVDD_UVLO_RAW	DVDD_UVLO_RAW	PWRUP_DONE_RAW	PWRDN_DONE_RAW	PVDD_UVLO_SHDN_RAW	VBAT_UVLO_SHDN_RAW	DHT_ACTIVE_BGN_RAW	DHT_ACTIVE_END_RAW
0x2004	Interrupt Raw 4[7:0]	-	-	-	-	BPE_LO_RAW	BPE_LEVEL_RAW	BPE_ACTIVE_BGN_RAW	BPE_ACTIVE_END_RAW
0x2006	Interrupt State 1[7:0]	THERM_SHDN_BGN_STATE	THERM_SHDN_END_STATE	THERM_WARN1_BGN_STATE	THERM_WARN1_END_STATE	THERMF_B_BGN_STATE	THERMF_B_END_STATE	OTP_FAIL_STATE	SPK_OVC_STATE
0x2007	Interrupt State 2[7:0]	THERM_WARN2_BGN_STATE	THERM_WARN2_END_STATE	INT_SPK_MON_ERR_STATE	INT_CLK_ERR_STATE	-	CLK_RECOVER_STATE	CLK_ERR_STATE	DMON_ERR_STATE
0x2008	Interrupt State 3[7:0]	AVDD_UVLO_STATE	DVDD_UVLO_STATE	PWRUP_DONE_STATE	PWRDN_DONE_STATE	PVDD_UVLO_SHDN_STATE	VBAT_UVLO_SHDN_STATE	DHT_ACTIVE_BGN_STATE	DHT_ACTIVE_END_STATE
0x2009	Interrupt State 4[7:0]	-	-	-	-	BPE_LO_STATE	BPE_LEVEL_STATE	BPE_ACTIVE_BGN_STATE	BPE_ACTIVE_END_STATE
0x200B	Interrupt Flag 1[7:0]	THERM_SHDN_BGN_FLAG	THERM_SHDN_END_FLAG	THERM_WARN1_BGN_FLAG	THERM_WARN1_END_FLAG	THERMF_B_BGN_FLAG	THERMF_B_END_FLAG	OTP_FAIL_FLAG	SPK_OVC_FLAG
0x200C	Interrupt Flag 2[7:0]	THERM_WARN2_BGN_FLAG	THERM_WARN2_END_FLAG	INT_SPK_MON_ERR_FLAG	INT_CLK_ERR_FLAG	-	CLK_RECOVER_FLAG	CLK_ERR_FLAG	DMON_ERR_FLAG
0x200D	Interrupt Flag 3[7:0]	AVDD_UVLO_FLAG	DVDD_UVLO_FLAG	PWRUP_DONE_FLAG	PWRDN_DONE_FLAG	PVDD_UVLO_SHDN_FLAG	VBAT_UVLO_SHDN_FLAG	DHT_ACTIVE_BGN_FLAG	DHT_ACTIVE_END_FLAG

ADDRESS	NAME	MSB							LSB
0x200E	Interrupt Flag 4[7:0]	-	-	-	-	BPE_L0_FLAG	BPE_LEVEL_FLAG	BPE_ACTIVE_BGN_FLAG	BPE_ACTIVE_END_FLAG
0x2010	Interrupt Enable 1[7:0]	THERM_SHDN_BGN_EN	THERM_SHDN_END_EN	THERM_WARN1_BGN_EN	THERM_WARN1_END_EN	THERMF_B_BGN_EN	THERMF_B_END_EN	OTP_FAIL_EN	SPK_OVC_EN
0x2011	Interrupt Enable 2[7:0]	THERM_WARN2_BGN_EN	THERM_WARN2_END_EN	INT_SPK_MON_ERR_EN	INT_CLK_ERR_EN	-	CLK_RECOVER_EN	CLK_ERR_EN	DMON_ERR_EN
0x2012	Interrupt Enable 3[7:0]	AVDD_UVLO_EN	DVDD_UVLO_EN	PWRUP_DONE_EN	PWRDN_DONE_EN	PVDD_UVLO_SHDN_EN	VBAT_UVLO_SHDN_EN	DHT_ACTIVE_BGN_EN	DHT_ACTIVE_END_EN
0x2013	Interrupt Enable 4[7:0]	-	-	-	-	BPE_L0_EN	BPE_LEVEL_EN	BPE_ACTIVE_BGN_EN	BPE_ACTIVE_END_EN
0x2015	Interrupt Flag Clear 1[7:0]	THERM_SHDN_BGN_CLR	THERM_SHDN_END_CLR	THERM_WARN1_BGN_CLR	THERM_WARN1_END_CLR	THERMF_B_BGN_CLR	THERMF_B_END_CLR	OTP_FAIL_CLR	SPK_OVC_CLR
0x2016	Interrupt Flag Clear 2[7:0]	THERM_WARN2_BGN_CLR	THERM_WARN2_END_CLR	INT_SPK_MON_ERR_CLR	INT_CLK_ERR_CLR	-	CLK_RECOVER_CLR	CLK_ERR_CLR	DMON_ERR_CLR
0x2017	Interrupt Flag Clear 3[7:0]	AVDD_UVLO_CLR	DVDD_UVLO_CLR	PWRUP_DONE_CLR	PWRDN_DONE_CLR	PVDD_UVLO_SHDN_CLR	VBAT_UVLO_SHDN_CLR	DHT_ACTIVE_BGN_CLR	DHT_ACTIVE_END_CLR
0x2018	Interrupt Flag Clear 4[7:0]	-	-	-	-	BPE_L0_CLR	BPE_LEVEL_CLR	BPE_ACTIVE_BGN_CLR	BPE_ACTIVE_END_CLR
0x201F	IRQ Control[7:0]	-	-	-	-	-	IRQ_MODE	IRQ_PO_L	IRQ_EN
Thermal Protection									
0x2020	Thermal Warning Threshold[7:0]	-	THERMWARN1_THRESH[6:0]						
0x2021	Warning Threshold 2[7:0]	-	THERMWARN2_THRESH[6:0]						
0x2022	Thermal Shutdown Threshold[7:0]	-	THERMSHDN_THRESH[6:0]						
0x2023	Thermal Hysteresis[7:0]	-	-	-	-	-	-	THERM_HYST[1:0]	
0x2024	Thermal Foldback Settings[7:0]	THERMFB_HOLD[1:0]		THERMFB_RLS[1:0]		THERMFB_SLOPE2[1:0]		THERMFB_SLOPE1[1:0]	
0x2027	Thermal Foldback Enable[7:0]	-	-	-	-	-	-	-	THERMF_B_EN
Noise Gate and Idle Mode									
0x2030	Noise Gate/Idle Mode Control[7:0]	NG_UNMUTE_THRESH[3:0]				NG_MUTE_THRESH[3:0]			
0x2033	Noise Gate/Idle Mode Enables[7:0]	-	-	-	-	-	-	IDLE_MODE_EN	NOISEGATE_EN

ADDRESS	NAME	MSB							LSB
Clock and Data Monitor Control									
0x2038	Clock Monitor Control[7:0]	-	CMON_BSELTOL[2:0]		CMON_ERRTOL[2:0]			CMON_AUTORESTART_EN	
0x2039	Data Monitor Control[7:0]	-	-	DMON_MAG_THRESH[1:0]	DMON_STUCK_THRES[1:0]	DMON_DURATION[1:0]			
0x203A	Speaker Monitor Threshold[7:0]	-	-	-	-	SPKMON_THRESH[3:0]			
0x203F	Enable Controls[7:0]	-	-	-	-	SPKMON_EN	DMON_MAG_EN	DMON_STUCK_EN	CMON_EN
PCM Registers									
0x2040	Pin Config[7:0]	LV_EN_DRV[1:0]		ICC_DRV[1:0]		IRQ_DRV[1:0]		DOUT_DRV[1:0]	
0x2041	PCM Mode Config[7:0]	PCM_CHANSZ[1:0]		PCM_FORMAT[2:0]			PCM_TX_INTERLEAVE	PCM_CHANSEL	PCM_TX_EXTRA_HIZ
0x2042	PCM Clock Setup[7:0]	-	-	-	PCM_BCLKEDGE	PCM_BSEL[3:0]			
0x2043	PCM Sample Rate Setup 1[7:0]	IVADC_SR[3:0]				PCM_SR[3:0]			
0x2044	PCM TX Control 1[7:0]	-	-	PCM_VMON_SLOT[5:0]					
0x2045	PCM TX Control 2[7:0]	-	-	PCM_IMON_SLOT[5:0]					
0x2046	PCM TX Control 3[7:0]	-	-	PCM_SUPPLY1_SLOT[5:0]					
0x2047	PCM TX Control 4[7:0]	-	-	PCM_SUPPLY2_SLOT[5:0]					
0x2048	PCM TX Control 5[7:0]	-	-	PCM_DHT_ATN_SLOT[5:0]					
0x2049	PCM TX Control 6[7:0]	-	-	PCM_STATUS_SLOT[5:0]					
0x204A	PCM TX Control 7[7:0]	-	-	PCM_DSP_MONITOR_SLOT[5:0]					
0x204B	PCM TX Control 8[7:0]	-	-	PCM_BPE_SLOT[5:0]					
0x204C	PCM TX Control 9[7:0]	-	-	PCM_THERM_SLOT[5:0]					
0x204D	PCM TX Control 10[7:0]	-	-	PCM_ICC_SLOT[5:0]					
0x204E	PCM Tx HiZ Control 1[7:0]	PCM_TX_SLOT_HIZ[63:56]							
0x204F	PCM Tx HiZ Control 2[7:0]	PCM_TX_SLOT_HIZ[55:48]							
0x2050	PCM Tx HiZ Control 3[7:0]	PCM_TX_SLOT_HIZ[47:40]							
0x2051	PCM Tx HiZ Control 4[7:0]	PCM_TX_SLOT_HIZ[39:32]							
0x2052	PCM Tx HiZ Control 5[7:0]	PCM_TX_SLOT_HIZ[31:24]							
0x2053	PCM Tx HiZ Control 6[7:0]	PCM_TX_SLOT_HIZ[23:16]							
0x2054	PCM Tx HiZ Control 7[7:0]	PCM_TX_SLOT_HIZ[15:8]							
0x2055	PCM Tx HiZ Control 8[7:0]	PCM_TX_SLOT_HIZ[7:0]							

ADDRESS	NAME	MSB							LSB
0x2057	PCM RX Source 1[7:0]	-	-	-	-	-	-	-	PCM_DMMIX_CFG[1:0]
0x2058	PCM RX Source 2[7:0]	PCM_DMMIX_CH1_SOURCE[3:0]			PCM_DMMIX_CH0_SOURCE[3:0]				
0x2059	PCM Bypass Source[7:0]	-	-	-	-	PCM_BYPASS_SOURCE[3:0]			
0x205C	PCM TX Source Enables[7:0]	PCM_BP_E_EN	PCM_STATU _S _E_N	PCM_DHT_ATN_EN	PCM_SUPLY2_EN	PCM_SUPLY1_EN	PCM_DS_PMONITOR_EN	PCM_IMON_EN	PCM_VMON_E_N
0x205D	PCM TX Source Enables 2[7:0]	-	-	-	-	-	-	-	PCM_THERM_EN
0x205E	PCM Rx Enables[7:0]	-	-	-	-	-	-	PCM_BY_P_EN	PCM_RX_EN
0x205F	PCM Tx Enables[7:0]	-	-	-	-	-	-	-	PCM_TX_EN
0x2060	PCM Tx Supply Select[7:0]	-	-	-	-	-	-	-	SUPPLY_SELECT[1:0]
Interchip Communication									
0x2070	ICC Rx Enables A[7:0]	ICC_RX_CH7_E_N	ICC_RX_CH6_E_N	ICC_RX_CH5_E_N	ICC_RX_CH4_E_N	ICC_RX_CH3_E_N	ICC_RX_CH2_E_N	ICC_RX_CH1_E_N	ICC_RX_CH0_E_N
0x2071	ICC Rx Enables B[7:0]	ICC_RX_CH15_EN	ICC_RX_CH14_EN	ICC_RX_CH13_EN	ICC_RX_CH12_EN	ICC_RX_CH11_EN	ICC_RX_CH10_EN	ICC_RX_CH9_E_N	ICC_RX_CH8_E_N
0x2072	ICC Tx Control[7:0]	-	ICC_INT_ERLEAVE_MOD_E	ICC_DATA_SEL	-	ICC_TX_DEST[3:0]			
0x207F	ICC Enables[7:0]	-	-	-	-	-	ICC_OV_ER_DOUT_EN	ICC_LIN_K_EN	ICC_TX_EN
Tone Generator Control									
0x2083	Tone Generator and DC Config[7:0]	-	-	TONE_AMPLITUDE[1:0]		TONE_CONFIG[3:0]			
0x2084	Tone Generator DC Level 1[7:0]	TONE_DC[23:16]							
0x2085	Tone Generator DC Level 2[7:0]	TONE_DC[15:8]							
0x2086	Tone Generator DC Level 3[7:0]	TONE_DC[7:0]							
0x208F	Tone Generator Enable[7:0]	-	-	-	-	-	-	PINK_NOISE_EN	TONE_EN
Speaker Path Control									
0x2090	AMP volume control[7:0]	SPK_VOL[7:0]							
0x2091	AMP Path Gain[7:0]	-	-	-	SPK_GAIN_MAX[4:0]				
0x2092	AMP DSP Config[7:0]	-	SPK_WB_AND_FILTER_EN	SPK_SAFETY_EN	SPK_VOLL_RMPDN_BYPASS	SPK_VOLL_RMPUP_BYPASS	SPK_INVERT	SPK_DITH_EN	SPK_DCBLK_EN

ADDRESS	NAME	MSB							LSB
0x2093	SSM Configuration[7:0]	-	-	-	-	TRI_SSM_EN	-	TRI_SSM_MOD[1:0]	
0x2094	SPK Class DG Threshold[7:0]	-	-	-	SPK_DG_THRES[4:0]				
0x2095	SPK Class DG Headroom[7:0]	-	-	SPK_DG_SEL[1:0]		SPK_DG_HEADROOM[3:0]			
0x2096	SPK Class DG Hold Time[7:0]	-	SPK_DG_PEAK_HYST[2:0]		SPK_DG_HOLD_TIME[3:0]				
0x2097	SPK Class DG Delay[7:0]	-	-	SPK_DG_DELAY[5:0]					
0x2098	SPK Class DG Mode[7:0]	-	-	-	-	-	-	SPK_MODE[1:0]	
0x2099	SPK Class DG VBAT Level[7:0]	-	-	-	-	-	VBATLOW_OK_LVL[2:0]		
0x209A	SPK Edge Control[7:0]	-	-	-	-	-	TRI_FS_W2X_MODE	-	-
0x209B	SPK Path Wideband Only Enable[7:0]	-	-	-	-	-	-	-	SPK_WIDEBAND_ONLY_EN
0x209C	SPK Edge Control 1[7:0]	SPK_EN_TURNOFF_SLEW	-	-	-	SPK_SL_RATE_GMODE[3:0]			
0x209D	SPK Edge Control 2[7:0]	SPK_SL_RATE_LS[3:0]			SPK_SL_RATE_HS[3:0]				
0x209E	Amp Clip Gain[7:0]	-	-	-	-	SPK_GAIN[3:0]			
0x209F	Bypass Path Config[7:0]	-	-	-	-	-	-	BYP_WB_AND_FILTER_EN	BYP_INVERT
0x20AF	AMP enables[7:0]	-	-	-	-	-	-	SPK_FB_EN	SPK_EN
Meas ADC									
0x20B0	Meas ADC Sample Rate[7:0]	MEAS_ADC_VDDH_SR[1:0]		MEAS_ADC_TEMP_SR[1:0]		MEAS_ADC_PVDD_SR[1:0]		MEAS_ADC_VBAT_SR[1:0]	
0x20B1	Meas ADC PVDD Config[7:0]	-	-	-	MEAS_ADC_PVDD_FILTER_EN	MEAS_ADC_PVDD_FILTER_COEFF[3:0]			
0x20B2	Meas ADC VBAT Config[7:0]	-	-	-	MEAS_ADC_VBAT_FILTER_EN	MEAS_ADC_VBAT_FILTER_COEFF[3:0]			
0x20B3	Meas ADC Thermal Config[7:0]	-	-	-	MEAS_ADC_TEMP_FILTER_EN	MEAS_ADC_TEMP_FILTER_COEFF[3:0]			
0x20B4	Meas ADC VDDH Config[7:0]	-	-	-	MEAS_ADC_VDDH_FILTER_EN	MEAS_ADC_VDDH_FILTER_COEFF[3:0]			

ADDRESS	NAME	MSB							LSB
0x20B5	Meas ADC Readback Control 1[7:0]	-	-	-	-	MEAS_A DC_VDD H_RD_M ODE	MEAS_A DC_THE RM_RD_ MODE	MEAS_A DC_VBA T_RD_M ODE	MEAS_A DC_PVD D_RD_M ODE
0x20B6	Meas ADC Readback Control 2[7:0]	-	-	-	-	MEAS_A DC_VDD H_RD_U PD	MEAS_A DC_THE RM_RD_ UPD	MEAS_A DC_VBA T_RD_U PD	MEAS_A DC_PVD D_RD_U PD
0x20B7	Meas ADC PVDD Readback MSB[7:0]	MEAS_ADC_PVDD_DATA[8:1]							
0x20B8	Meas ADC PVDD Readback LSB[7:0]	-	-	-	-	-	-	-	MEAS_A DC_PVD D_DATA [0]
0x20B9	Meas ADC VBAT Readback MSB[7:0]	MEAS_ADC_VBAT_DATA[8:1]							
0x20BA	Meas ADC VBAT Readback LSB[7:0]	-	-	-	-	-	-	-	MEAS_A DC_VBA T_DATA[0]
0x20BB	Meas ADC Temp Readback MSB[7:0]	MEAS_ADC_THERM_DATA[8:1]							
0x20BC	Meas ADC Temp Readback LSB[7:0]	-	-	-	-	-	-	-	MEAS_A DC_THE RM_DAT A[0]
0x20BD	Meas ADC VDDH Readback MSB[7:0]	MEAS_ADC_VDDH_DATA[8:1]							
0x20BE	Meas ADC VDDH Readback LSB[7:0]	-	-	-	-	-	-	-	MEAS_A DC_VDD H_DATA [0]
0x20BF	Meas ADC Lowest PVDD Readback MSB[7:0]	LOWEST_PVDD_DATA[8:1]							
0x20C0	Meas ADC Lowest PVDD Readback LSB[7:0]	-	-	-	-	-	-	-	LOWES T_PVDD _DATA[0]
0x20C1	Meas ADC Lowest VBAT Readback MSB[7:0]	LOWEST_VBAT_DATA[8:1]							
0x20C2	Meas ADC Lowest VBAT Readback LSB[7:0]	-	-	-	-	-	-	-	LOWES T_VBAT _DATA[0]
0x20C3	Meas ADC Lowest VDDH Readback MSB[7:0]	LOWEST_VDDH_DATA[8:1]							
0x20C4	Meas ADC Lowest VDDH Readback LSB[7:0]	-	-	-	-	-	-	-	LOWES T_VDDH _DATA[0]

ADDRESS	NAME	MSB							LSB
0x20C5	Meas ADC Highest Thermal Readback MSB[7:0]	HIGHEST_THERM_DATA_MSB[7:0]							
0x20C6	Meas ADC Highest Thermal Readback LSB[7:0]	-	-	-	-	-	-	-	HIGHEST_THERM_DATA_LSB
0x20C7	Meas ADC Optimal Mode[7:0]	-	-	-	-	MEAS_ADC_OPT_AVE_SEL[1:0]		MEAS_ADC_OPT_MODE[1:0]	
0x20C8	Meas ADC Config[7:0]	-	-	-	-	-	MEAS_ADC_VDDH_EN	MEAS_ADC_VBAT_EN	MEAS_ADC_PVD_EN
Dynamic Headroom Tracking									
0x20D0	DHT Configuration 1[7:0]	-	-	-	-	DHT_VROT_PNT[3:0]			
0x20D1	Limiter Configuration 1[7:0]	-	-	-	DHT_HR[4:0]				
0x20D2	Limiter Configuration 2[7:0]	-	-	DHT_LIM_THRESH[4:0]					DHT_LIMIT_MODE
0x20D3	DHT Configuration 2[7:0]	-	-	-	DHT_MAX_ATN[4:0]				
0x20D4	DHT Configuration 3[7:0]	-	-	-	-	DHT_ATK_RATE[3:0]			
0x20D5	DHT Configuration 4[7:0]	-	-	-	-	DHT_RLS_RATE[3:0]			
0x20D6	DHT Supply Hysteresis Configuration[7:0]	-	-	-	-	DHT_SUPPLY_HYST[2:0]			DHT_SUPPLY_HYST_EN
0x20DF	DHT Enable[7:0]	-	-	-	-	-	-	-	DHT_EN
I_V Sense Path Control									
0x20E0	I_V Sense Path Config[7:0]	-	-	-	-	IVADC_WBAND_FILTER_EN	IVADC_DITH_EN	IVADC_IDCBLK_EN	IVADC_VDCBLK_EN
0x20E4	I_V Sense Path Enables[7:0]	-	-	-	-	-	IVADC_I _M _EN	IVADC_I _V _EN	IVADC_V _{EN}
Brownout Protection Engine									
0x20E5	BPE State[7:0]	-	-	-	-	-	BPE_STATE[2:0]		
0x20E6	BPE L3 Threshold MSB[7:0]	BPE_L3_VTHRESH[8:1]							
0x20E7	BPE L3 Threshold LSB[7:0]	-	-	-	-	-	-	-	BPE_L3_VTHRESH[0]
0x20E8	BPE L2 Threshold MSB[7:0]	BPE_L2_VTHRESH[8:1]							
0x20E9	BPE L2 Threshold LSB[7:0]	-	-	-	-	-	-	-	BPE_L2_VTHRESH[0]

ADDRESS	NAME	MSB						LSB	
0x20EA	BPE L1 Threshold MSB[7:0]	BPE_L1_VTHRESH[8:1]							
0x20EB	BPE L1 Threshold LSB[7:0]	-	-	-	-	-	-	BPE_L1_VTHRESH[0]	
0x20EC	BPE L0 Threshold MSB[7:0]	BPE_L0_VTHRESH[8:1]							
0x20ED	BPE L0 Threshold LSB[7:0]	-	-	-	-	-	-	BPE_L0_VTHRESH[0]	
0x20EE	BPE L3 Dwell and Hold Time[7:0]	-	-	BPE_L3_DWELL[2:0]		BPE_L3_HOLD[2:0]			
0x20EF	BPE L2 Dwell and Hold Time[7:0]	-	-	BPE_L2_DWELL[2:0]		BPE_L2_HOLD[2:0]			
0x20F0	BPE L1 Dwell and Hold Time[7:0]	-	-	BPE_L1_DWELL[2:0]		BPE_L1_HOLD[2:0]			
0x20F1	BPE L0 Hold Time[7:0]	-	-	-	-	BPE_L0_HOLD[2:0]			
0x20F2	BPE L3 Attack and Release Step[7:0]	-	-	-	-	BPE_L3_STEP[3:0]			
0x20F3	BPE L2 Attack and Release Step[7:0]	-	-	-	-	BPE_L2_STEP[3:0]			
0x20F4	BPE L1 Attack and Release Step[7:0]	-	-	-	-	BPE_L1_STEP[3:0]			
0x20F5	BPE L0 Attack and Release Step[7:0]	-	-	-	-	BPE_L0_STEP[3:0]			
0x20F6	BPE L3 Max Gain Attn[7:0]	-	-	-	BPE_L3_MAXATTN[4:0]				
0x20F7	BPE L2 Max Gain Attn[7:0]	-	-	-	BPE_L2_MAXATTN[4:0]				
0x20F8	BPE L1 Max Gain Attn[7:0]	-	-	-	BPE_L1_MAXATTN[4:0]				
0x20F9	BPE L0 Max Gain Attn[7:0]	-	-	-	BPE_L0_MAXATTN[4:0]				
0x20FA	BPE L3 Gain Attack and Rls Rates[7:0]	-	-	BPE_L3_GAIN_RLS[2:0]		BPE_L3_GAIN_ATK[2:0]			
0x20FB	BPE L2 Gain Attack and Rls Rates[7:0]	-	-	BPE_L2_GAIN_RLS[2:0]		BPE_L2_GAIN_ATK[2:0]			
0x20FC	BPE L1 Gain Attack and Rls Rates[7:0]	-	-	BPE_L1_GAIN_RLS[2:0]		BPE_L1_GAIN_ATK[2:0]			
0x20FD	BPE L0 Gain Attack and Rls Rates[7:0]	-	-	BPE_L0_GAIN_RLS[2:0]		BPE_L0_GAIN_ATK[2:0]			
0x20FE	BPE L3 Limiter Config[7:0]	-	-	-	-	BPE_L3_LIM[3:0]			
0x20FF	BPE L2 Limiter Config[7:0]	-	-	-	-	BPE_L2_LIM[3:0]			
0x2100	BPE L1 Limiter Config[7:0]	-	-	-	-	BPE_L1_LIM[3:0]			
0x2101	BPE L0 Limiter Config[7:0]	-	-	-	-	BPE_L0_LIM[3:0]			

ADDRESS	NAME	MSB							LSB
0x2102	BPE L3 Limiter Attack and Release Rates[7:0]	-	-	BPE_L3_LIM_RLS[2:0]			BPE_L3_LIM_ATK[2:0]		
0x2103	BPE L2 Limiter Attack and Release Rates[7:0]	-	-	BPE_L2_LIM_RLS[2:0]			BPE_L2_LIM_ATK[2:0]		
0x2104	BPE L1 Limiter Attack and Release Rates[7:0]	-	-	BPE_L1_LIM_RLS[2:0]			BPE_L1_LIM_ATK[2:0]		
0x2105	BPE L0 Limiter Attack and Release Rates[7:0]	-	-	BPE_L0_LIM_RLS[2:0]			BPE_L0_LIM_ATK[2:0]		
0x2106	BPE Threshold Hysteresis[7:0]	BPE_VTHRESH_HYST[7:0]							
0x2107	BPE Infinite Hold Clear[7:0]	-	-	-	-	-	-	-	BPE_HL D_RLS
0x2108	BPE Supply Source[7:0]	-	-	-	-	-	-	BPE_SRC_SEL[1:0]	
0x2109	BPE Lowest State[7:0]	-	-	-	-	-	BPE_LOWEST[2:0]		
0x210A	BPE Lowest Gain[7:0]	BPE_LOWEST_GAIN[7:0]							
0x210B	BPE Lowest Limiter[7:0]	BPE_LOWEST_LIMIT[7:0]							
0x210D	BPE Enable[7:0]	-	-	-	-	-	-	BPE_LI M_EN	BPE_EN
System Configuration									
0x210E	Auto-Restart Behavior[7:0]	-	-	-	-	OVC_AU TORESTART_EN	THERM AUTORESTART_EN	VBAT_A UTORESTART_EN	PVDD_A UTORESTART_EN
0x210F	Global Enable[7:0]	-	-	-	-	-	-	-	EN
Device and Revision ID									
0x22FF	Revision ID[7:0]	REV_ID[7:0]							

Register Details

[Software Reset \(0x2000\)](#)

BIT	7	6	5	4	3	2	1	0	
Field	-	-	-	-	-	-	-	RST	
Reset	-	-	-	-	-	-	-	0b0	
Access Type	-	-	-	-	-	-	-	Write Only	
BITFIELD	BITS	DESCRIPTION				DECODE			
RST	0	This bit field is used to trigger a software reset event. Writing a 1 resets the device and returns the control registers to their power-on reset states. Writing a 0 has no effect, and readback always returns 0.				0: No action. 1: Triggers a software reset event.			

[Interrupt Raw 1 \(0x2001\)](#)

BIT	7	6	5	4	3	2	1	0
Field	THERMSH DN_BGN_R AW	THERMSH DN_END_R AW	THERMWA RN1_BGN_ RAW	THERMWA RN1_END_ RAW	THERMFB_ BGN_RAW	THERMFB_ END_RAW	OTP_FAIL_ RAW	SPK_OVC_ RAW
Reset	0b0	0b0	0b0	0b0	0b0	0b0	0b0	0b0
Access Type	Read Only	Read Only	Read Only	Read Only	Read Only	Read Only	Read Only	Read Only

BITFIELD	BITS	DESCRIPTION	DECODE
THERMSHD N_BGN_RA W	7	Raw value of thermal shutdown begin indicator.	0: Die temperature below thermal shutdown limit. 1: Die temperature above thermal shutdown limit.
THERMSHD N_END_RA W	6	Raw value of thermal shutdown end indicator.	0: Die temperature above thermal shutdown limit. 1: Die temperature has dropped below thermal shutdown limit.
THERMWAR N1_BGN_RA W	5	Raw value of thermal-warning1 begin indicator.	0: Die temperature below thermal-warning1 limit. 1: Die temperature above thermal- warning1 limit.
THERMWAR N1_END_RA W	4	Raw value of thermal-warning1 end indicator.	0: Die temperature above thermal-warning1 limit. 1: Die temperature has dropped below thermal-warning1 limit.
THERMFB_B GN_RAW	3	Raw value of thermal foldback begin.	0: The thermal foldback is not active. 1: Thermal foldback is active.
THERMFB_E ND_RAW	2	Raw value of thermal foldback end.	0: The thermal foldback is active. 1: Thermal foldback has ended.
OTP_FAIL_R AW	1	Raw status of OTP load fail.	0: No OTP load failure. 1: The OTP load routine did not complete successfully.
SPK_OVC_R AW	0	Raw value of speaker overcurrent limit.	0: Speaker overcurrent limit inactive. 1: Speaker overcurrent limit active.

[Interrupt Raw 2 \(0x2002\)](#)

BIT	7	6	5	4	3	2	1	0
Field	THERMWA RN2_BGN_ RAW	THERMWA RN2_END_ RAW	INT_SPKM ON_ERR_R AW	INT_CLK_E RR_RAW	–	CLK_RECO VER_RAW	CLK_ERR_ RAW	DMON_ER R_RAW
Reset	0b0	0b0	0b0	0x0	–	0x0	0x0	0b0
Access Type	Read Only	Read Only	Read Only	Read Only	–	Read Only	Read Only	Read Only

BITFIELD	BITS	DESCRIPTION	DECODE
THERMWAR N2_BGN_RA W	7	Raw value of thermal-warning2 begin indicator.	0: Die temperature below thermal-warning2 limit. 1: Die temperature above thermal-warning2 limit.
THERMWAR N2_END_RA W	6	Raw value of thermal-warning2 end indicator.	0: Die temperature above thermal-warning2 limit. 1: Die temperature has dropped below thermal-warning2 limit.
INT_SPKMO N_ERR_RA W	5	Raw value of the internal speaker monitor status indicator.	0: Internal speaker monitor not reporting data error. 1: Internal speaker monitor reporting data error.

BITFIELD	BITS	DESCRIPTION	DECODE
INT_CLK_ERR_RAW	4	Raw value of internal clock error indicator.	0: Internal clock monitor not reporting clock error. 1: Internal clock monitor reporting clock error.
CLK_RECOVER_RAW	2	Raw value of the external clock monitor error recovery indicator.	0: Clock monitor not reporting clock error recovery. 1: Clock monitor reporting clock error recovery.
CLK_ERR_RAW	1	Raw value of the external clock monitor error indicator.	0: No external clock error detected. 1: Clock monitor reporting clock error.
DMON_ERR_RAW	0	Raw value of external data monitor error indicator.	0: No external data error detected. 1: Data monitor reporting data error.

Interrupt Raw 3 (0x2003)

BIT	7	6	5	4	3	2	1	0
Field	AVDD_UVLO_RAW	DVDD_UVLO_RAW	PWRUP_DONE_RAW	PWRDN_DONE_RAW	PVDD_UVLO_SHDN_RAW	VBAT_UVLO_SHDN_RAW	DHT_ACTIVE_BGN_RAW	DHT_ACTIVE_END_RAW
Reset	0b0	0b0	0b0	0b0	0b0	0b0	0b0	0b0
Access Type	Read Only	Read Only	Read Only	Read Only	Read Only	Read Only	Read Only	Read Only

BITFIELD	BITS	DESCRIPTION	DECODE
AVDD_UVLO_RAW	7	Raw value of AVDD UVLO error indicator.	0: No AVDD UVLO error. 1: AVDD below UVLO threshold in the active state.
DVDD_UVLO_RAW	6	Raw value of DVDD UVLO error indicator.	0: No DVDD UVLO error. 1: DVDD below UVLO threshold in the active state.
PWRUP_DONE_RAW	5	Raw value of power-up done.	0: Device is not reporting a power-up event. 1: Device is reporting a power-up into the active state with the speaker amplifier enabled.
PWRDN_DONE_RAW	4	Raw value of power-down done.	0: Device is not reporting a power-down into software shutdown event. 1: Device is reporting a power-down into software shutdown event.
PVDD_UVLO_SHDN_RAW	3	Raw value of PVDD UVLO error indicator.	0: No PVDD UVLO error. 1: PVDD below UVLO threshold in the active state.
VBAT_UVLO_SHDN_RAW	2	Raw value of VBAT UVLO error Indicator.	0: No VBAT UVLO error. 1: VBAT below UVLO threshold in the active state.
DHT_ACTIVE_BGN_RAW	1	Raw value of DHT active begin.	0: DHT is not active. 1: DHT is active.
DHT_ACTIVE_END_RAW	0	Raw value of DHT active end.	0: DHT is currently active or has not yet applied attenuation. 1: DHT activity has ended.

[Interrupt Raw 4 \(0x2004\)](#)

BIT	7	6	5	4	3	2	1	0
Field	–	–	–	–	BPE_L0_RA W	BPE_LEVE L_RAW	BPE_ACTIV E_BGN_RA W	BPE_ACTIV E_END_RA W
Reset	–	–	–	–	0x0	0x0	0x0	0x0
Access Type	–	–	–	–	Read Only	Read Only	Read Only	Read Only

BITFIELD	BITS	DESCRIPTION	DECODE
BPE_L0_RA W	3	Indicates that BPE has transitioned into level 0.	0: BPE controller is not in level 0. 1: BPE controller has transitioned into level 0.
BPE_LEVEL _RAW	2	Indicates that BPE has transitioned between levels.	0: BPE is static. 1: BPE level is changing.
BPE_ACTIV E_BGN_RA W	1	Indicates that the BPE is active.	0: Brownout-protection engine is inactive. 1: Brownout-protection engine is active.
BPE_ACTIV E_END_RA W	0	Indicates that the BPE is no longer active.	0: Brownout-protection engine is active. 1: Brownout-protection engine is inactive.

[Interrupt State 1 \(0x2006\)](#)

BIT	7	6	5	4	3	2	1	0
Field	THERMSH DN_BGN_S TATE	THERMSH DN_END_S TATE	THERMWA RN1_BGN_ STATE	THERMWA RN1_END_ STATE	THERMFB_ BGN_STAT E	THERMFB_ END_STAT E	OTP_FAIL_ STATE	SPK_OVC_ STATE
Reset	0b0	0b0	0b0	0b0	0b0	0b0	0b0	0b0
Access Type	Read Only	Read Only	Read Only	Read Only	Read Only	Read Only	Read Only	Read Only

BITFIELD	BITS	DESCRIPTION	DECODE
THERMSHD N_BGN_STA TE	7	Unmaskable interrupt state, cleared by THERMSHDN_BGN_CLR.	0: No rising edge of THERMSHDN_BGN_RAW since last THERMSHDN_BGN_CLR. 1: Rising edge of THERMSHDN_BGN_RAW since last THERMSHDN_BGN_CLR.
THERMSHD N_END_STA TE	6	Unmaskable interrupt state, cleared by THERMSHDN_END_CLR.	0: No rising edge of THERMSHDN_END_RAW since last THERMSHDN_END_CLR. 1: Rising edge of THERMSHDN_END_RAW since last THERMSHDN_END_CLR.
THERMWAR N1_BGN_ST ATE	5	Unmaskable interrupt state, cleared by THERMWAR N1_BGN_CLR.	0: No rising edge of THERMWAR N1_BGN_RAW since last THERMWAR N1_BGN_CLR. 1: Rising edge of THERMWAR N1_BGN_RAW since last THERMWAR N1_BGN_CLR.
THERMWAR N1_END_ST ATE	4	Unmaskable interrupt state, cleared by THERMWAR N1_END_CLR.	0: No rising edge of THERMWAR N1_END_RAW since last THERMWAR N1_END_CLR. 1: Rising edge of THERMWAR N1_END_RAW since last THERMWAR N1_END_CLR.
THERMFB_B GN_STATE	3	Unmaskable interrupt state, cleared by THERMFB_BGN_CLR.	0: No rising edge of THERMFB_BGN_RAW since last THERMFB_BGN_CLR. 1: Rising edge of THERMFB_BGN_RAW since last THERMFB_BGN_CLR.

BITFIELD	BITS	DESCRIPTION	DECODE
THERMFB_END_STATE	2	Unmaskable interrupt state, cleared by THERMFB_END_CLR.	0: No rising edge of THERMFB_END_RAW since last THERMFB_END_CLR. 1: Rising edge of THERMFB_END_RAW since last THERMFB_END_CLR.
OTP_FAIL_STATE	1	Unmaskable interrupt state, cleared by OTP_FAIL_CLR.	0: No rising edge of OTP_FAIL_RAW since last OTP_FAIL_CLR. 1: Rising edge of OTP_FAIL_RAW since last OTP_FAIL_CLR.
SPK_OVC_STATE	0	Unmaskable interrupt state, cleared by SPK_OVC_CLR.	0: No rising edge of SPK_OVC_RAW since last SPK_OVC_CLR. 1: Rising edge of SPK_OVC_RAW since last SPK_OVC_CLR.

Interrupt State 2 (0x2007)

BIT	7	6	5	4	3	2	1	0
Field	THERMWAR N2_BGN_ STATE	THERMWAR N2_END_ STATE	INT_SPKM ON_ERR_ STATE	INT_CLK_E RR_STATE	–	CLK_RECO VER_STAT E	CLK_ERR_ STATE	DMON_ER R_STATE
Reset	0b0	0b0	0b0	0x0	–	0x0	0x0	0b0
Access Type	Read Only	Read Only	Read Only	Read Only	–	Read Only	Read Only	Read Only

BITFIELD	BITS	DESCRIPTION	DECODE
THERMWAR N2_BGN_ STATE	7	Unmaskable interrupt state, cleared by THERMWAR N2_BGN_CLR.	0: No rising edge of THERMWAR N2_BGN_RAW since last THERMWAR N2_BGN_CLR. 1: Rising edge of THERMWAR N2_BGN_RAW since last THERMWAR N2_BGN_CLR.
THERMWAR N2_END_ STATE	6	Unmaskable interrupt state, cleared by THERMWAR N2_END_CLR.	0: No rising edge of THERMWAR N2_END_RAW since last THERMWAR N2_END_CLR. 1: Rising edge of THERMWAR N2_END_RAW since last THERMWAR N2_END_CLR.
INT_SPKM ON_ERR_ STATE	5	Unmaskable interrupt state, cleared by INT_SPKM ON_ERR_CLR.	0: No rising edge of INT_SPKM ON_ERR_RAW since last INT_SPKM ON_ERR_CLR. 1: Rising edge of INT_SPKM ON_ERR_RAW since last INT_SPKM ON_ERR_CLR.
INT_CLK_E RR_STATE	4	Unmaskable interrupt state, cleared by INT_CLK_E RR_CLR.	0: No rising edge of INT_CLK_E RR_RAW since last INT_CLK_E RR_CLR. 1: Rising edge of INT_CLK_E RR_RAW since last INT_CLK_E RR_CLR.
CLK_RECO VER_ STATE	2	Unmaskable interrupt state, cleared by CLK_RECO VER_CLR.	0: No rising edge of CLK_RECO VER_RAW since last CLK_RECO VER_CLR. 1: Rising edge of CLK_RECO VER_RAW since last CLK_RECO VER_CLR.
CLK_ERR_ STATE	1	Unmaskable interrupt state, cleared by CLK_ERR_ CLR.	0: No rising edge of CLK_ERR_ RAW since last CLK_ERR_ CLR. 1: Rising edge of CLK_ERR_ RAW since last CLK_ERR_ CLR.
DMON_ER R_ STATE	0	Unmaskable interrupt state, cleared by DMON_ER R_CLR.	0: No rising edge of DMON_ER R_RAW since last DMON_ER R_CLR. 1: Rising edge of DMON_ER R_RAW since last DMON_ER R_CLR.

[Interrupt State 3 \(0x2008\)](#)

BIT	7	6	5	4	3	2	1	0
Field	AVDD_UVLO_STATE	DVDD_UVLO_STATE	PWRUP_DONE_STATE	PWRDN_DONE_STATE	PVDD_UVLO_SHDN_STATE	VBAT_UVLO_SHDN_STATE	DHT_ACTIVE_BGN_STATE	DHT_ACTIVE_END_STATE
Reset	0b0	0b0	0b0	0b0	0b0	0b0	0b0	0b0
Access Type	Read Only	Read Only	Read Only	Read Only	Read Only	Read Only	Read Only	Read Only

BITFIELD	BITS	DESCRIPTION	DECODE
AVDD_UVLO_STATE	7	Unmaskable interrupt state, cleared by AVDD_UVLO_CLR.	0: No rising edge of AVDD_UVLO_RAW since last AVDD_UVLO_CLR. 1: Rising edge of AVDD_UVLO_RAW since last AVDD_UVLO_CLR.
DVDD_UVLO_STATE	6	Unmaskable interrupt state, cleared by DVDD_UVLO_CLR.	0: No rising edge of DVDD_UVLO_RAW since last DVDD_UVLO_CLR. 1: Rising edge of DVDD_UVLO_RAW since last DVDD_UVLO_CLR.
PWRUP_DONE_STATE	5	Unmaskable interrupt state, cleared by PWRUP_DONE_CLR.	0: No rising edge of PWRUP_DONE_RAW since last PWRUP_DONE_CLR. 1: Rising edge of PWRUP_DONE_RAW since last PWRUP_DONE_CLR.
PWRDN_DONE_STATE	4	Unmaskable interrupt state, cleared by PWRDN_DONE_CLR.	0: No rising edge of PWRDN_DONE_RAW since last PWRDN_DONE_CLR. 1: Rising edge of PWRDN_DONE_RAW since last PWRDN_DONE_CLR.
PVDD_UVLO_SHDN_STATE	3	Unmaskable interrupt state, cleared by PVDD_UVLO_SHDN_CLR.	0: No rising edge of PVDD_UVLO_SHDN_RAW since last PVDD_UVLO_SHDN_CLR. 1: Rising edge of PVDD_UVLO_SHDN_RAW since last PVDD_UVLO_SHDN_CLR.
VBAT_UVLO_SHDN_STATE	2	Unmaskable interrupt state, cleared by VBAT_UVLO_SHDN_CLR.	0: No rising edge of VBAT_UVLO_SHDN_RAW since last VBAT_UVLO_SHDN_CLR. 1: Rising edge of VBAT_UVLO_SHDN_RAW since last VBAT_UVLO_SHDN_CLR.
DHT_ACTIVE_BGN_STATE	1	Unmaskable interrupt state, cleared by DHT_ACTIVE_BGN_CLR.	0: No rising edge of DHT_ACTIVE_BGN_RAW since last DHT_ACTIVE_BGN_CLR. 1: Rising edge of DHT_ACTIVE_BGN_RAW since last DHT_ACTIVE_BGN_CLR.
DHT_ACTIVE_END_STATE	0	Unmaskable interrupt state, cleared by DHT_ACTIVE_END_CLR.	0: No rising edge of DHT_ACTIVE_END_RAW since last DHT_ACTIVE_END_CLR. 1: Rising edge of DHT_ACTIVE_END_RAW since last DHT_ACTIVE_END_CLR.

[Interrupt State 4 \(0x2009\)](#)

BIT	7	6	5	4	3	2	1	0
Field	–	–	–	–	BPE_LO_STATE	BPE_LEVEL_STATE	BPE_ACTIVE_BGN_STATE	BPE_ACTIVE_END_STATE
Reset	–	–	–	–	0x0	0x0	0x0	0x0
Access Type	–	–	–	–	Read Only	Read Only	Read Only	Read Only

BITFIELD	BITS	DESCRIPTION	DECODE
BPE_L0_STATE	3	Unmaskable interrupt state, cleared by BPE_L0_CLR.	0: No rising edge of BPE_L0_RAW since last BPE_L0_CLR. 1: Rising edge of BPE_L0_RAW since last BPE_L0_CLR.
BPE_LEVEL_STATE	2	Unmaskable interrupt state, cleared by BPE_LEVEL_CLR.	0: No rising edge of BPE_LEVEL_RAW since last BPE_LEVEL_CLR. 1: Rising edge of BPE_LEVEL_RAW since last BPE_LEVEL_CLR.
BPE_ACTIVE_BGN_STATE	1	Unmaskable interrupt state, cleared by BPE_ACTIVE_END_CLR.	0: No rising edge of BPE_ACTIVE_BGN_RAW since last BPE_ACTIVE_BGN_CLR. 1: Rising edge of BPE_ACTIVE_BGN_RAW since last BPE_ACTIVE_BGN_CLR.
BPE_ACTIVE_END_STATE	0	Unmaskable interrupt state, cleared by BPE_ACTIVE_END_CLR.	0: No rising edge of BPE_ACTIVE_END_RAW since last BPE_ACTIVE_END_CLR. 1: Rising edge of BPE_ACTIVE_END_RAW since last BPE_ACTIVE_END_CLR.

Interrupt Flag 1 (0x200B)

BIT	7	6	5	4	3	2	1	0
Field	THERMSHDN_BGN_FLAG	THERMSHDN_END_FLAG	THERMWAR1_BGN_FLAG	THERMWAR1_END_FLAG	THERMFB_BGN_FLAG	THERMFB_END_FLAG	OTP_FAIL_FLAG	SPK_OVC_FLAG
Reset	0b0	0b0	0b0	0b0	0b0	0b0	0b0	0b0
Access Type	Read Only	Read Only	Read Only	Read Only	Read Only	Read Only	Read Only	Read Only

BITFIELD	BITS	DESCRIPTION	DECODE
THERMSHDN_BGN_FLAG	7	Thermal Shutdown Begin Event Maskable Interrupt Flag. Masked by THERMSHDN_END_EN and cleared by THERMSHDN_END_CLR. If IRQ is enabled, an interrupt is generated on a flag bit rising edge.	0: No rising edge of THERMSHDN_BGN_RAW since last THERMSHDN_BGN_CLR or THERMSHDN_BGN_EN is low. 1: THERMSHDN_BGN_EN is high and rising edge of THERMSHDN_BGN_RAW since last THERMSHDN_BGN_CLR.
THERMSHDN_END_FLAG	6	Thermal Shutdown End Event Maskable Interrupt Flag. Masked by THERMSHDN_END_EN and cleared by THERMSHDN_END_CLR. If IRQ is enabled, an interrupt is generated on a flag bit rising edge.	0: No rising edge of THERMSHDN_END_RAW since last THERMSHDN_END_CLR or THERMSHDN_END_EN is low. 1: THERMSHDN_END_EN is high and rising edge of THERMSHDN_END_RAW since last THERMSHDN_END_CLR.
THERMWAR1_BGN_FLAG	5	Thermal-warning1 Begin Event Maskable Interrupt Flag. Masked by THERMWAR1_BGN_EN and cleared by THERMWAR1_BGN_CLR. If IRQ is enabled, an interrupt is generated on a flag bit rising edge.	0: No rising edge of THERMWAR1_BGN_RAW since last THERMWAR1_BGN_CLR or THERMWAR1_BGN_EN is low. 1: THERMWAR1_BGN_EN is high and rising edge of THERMWAR1_BGN_RAW since last THERMWAR1_BGN_CLR.
THERMWAR1_END_FLAG	4	Thermal-warning1 End Event Maskable Interrupt Flag. Masked by THERMWAR1_END_EN and cleared by THERMWAR1_END_CLR. If IRQ is enabled, an interrupt is generated on a flag bit rising edge.	0: No rising edge of THERMWAR1_END_RAW since last THERMWAR1_END_CLR or THERMWAR1_END_EN is low. 1: THERMWAR1_END_EN is high and rising edge of THERMWAR1_END_RAW since last THERMWAR1_END_CLR.

BITFIELD	BITS	DESCRIPTION	DECODE
THERMFB_BGN_FLAG	3	Thermal Foldback Begin Event Maskable Interrupt Flag. Masked by THERMFB_BGN_EN and cleared by THERMFB_BGN_CLR. If IRQ is enabled, an interrupt is generated on a flag bit rising edge.	0: No rising edge of THERMFB_BGN_RAW since last THERMFB_BGN_CLR or THERMFB_BGN_EN is low. 1: THERMFB_BGN_EN is high and rising edge of THERMFB_BGN_RAW since last THERMFB_BGN_CLR.
THERMFB_END_FLAG	2	Thermal Foldback End Event Maskable Interrupt Flag. Masked by THERMFB_END_EN and cleared by THERMFB_END_CLR. If IRQ is enabled, an interrupt is generated on a flag bit rising edge.	0: No rising edge of THERMFB_END_RAW since last THERMFB_END_CLR or THERMFB_END_EN is low. 1: THERMFB_END_EN is high and rising edge of THERMFB_END_RAW since last THERMFB_END_CLR.
OTP_FAIL_FLAG	1	OTP Load Routine Fail Event Maskable Interrupt Flag. Masked by OTP_FAIL_EN and cleared by OTP_FAIL_CLR. If IRQ is enabled, an interrupt is generated on a flag bit rising edge.	0: No rising edge of OTP_FAIL_RAW since last OTP_FAIL_CLR or OTP_FAIL_EN is low. 1: OTP_FAIL_EN is high and rising edge of OTP_FAIL_RAW since last OTP_FAIL_CLR.
SPK_OVC_FLAG	0	Speaker Overcurrent Event Maskable Interrupt Flag. Masked by SPK_OVC_EN and cleared by SPK_OVC_CLR. If IRQ is enabled, an interrupt is generated on a flag bit rising edge.	0: No rising edge of SPK_OVC_RAW since last SPK_OVC_CLR or SPK_OVC_EN is low. 1: SPK_OVC_EN is high and rising edge of SPK_OVC_RAW since last SPK_OVC_CLR.

Interrupt Flag 2 (0x200C)

BIT	7	6	5	4	3	2	1	0
Field	THERMWAR N2_BGN_ FLAG	THERMWA RN2_END_ FLAG	INT_SPKM ON_ERR_F LAG	INT_CLK_E RR_FLAG	–	CLK_RECO VER_FLAG	CLK_ERR_ FLAG	DMON_ER R_FLAG
Reset	0b0	0b0	0b0	0x0	–	0x0	0x0	0b0
Access Type	Read Only	Read Only	Read Only	Read Only	–	Read Only	Read Only	Read Only

BITFIELD	BITS	DESCRIPTION	DECODE
THERMWAR N2_BGN_FL AG	7	Thermal-warning2 Begin Event Maskable Interrupt Flag. Masked by THERMWAR2_BGN_EN and cleared by THERMWAR2_BGN_CLR. If IRQ is enabled, an interrupt is generated on a flag bit rising edge.	0: No rising edge of THERMWAR2_BGN_RAW since last THERMWAR2_BGN_CLR or THERMWAR2_BGN_EN is low. 1: THERMWAR2_BGN_EN is high and rising edge of THERMWAR2_BGN_RAW since last THERMWAR2_BGN_CLR.
THERMWAR N2_END_FL AG	6	Thermal-warning2 End Event Maskable Interrupt Flag. Masked by THERMWAR2_END_EN and cleared by THERMWAR2_END_CLR. If IRQ is enabled, an interrupt is generated on a flag bit rising edge.	0: No rising edge of THERMWAR2_END_RAW since last THERMWAR2_END_CLR or THERMWAR2_END_EN is low. 1: THERMWAR2_END_EN is high and rising edge of THERMWAR2_END_RAW since last THERMWAR2_END_CLR.
INT_SPKMO N_ERR_FLA G	5	Internal Speaker Data Monitor Error Event Maskable Interrupt Flag. Masked by INT_SPKMON_ERR_EN and cleared by INT_SPKMON_ERR_CLR. If IRQ is enabled, an interrupt is generated on a flag bit rising edge.	0: No rising edge of INT_SPKMON_ERR_RAW since last INT_SPKMON_ERR_CLR or INT_SPKMON_ERR_EN is low. 1: INT_SPKMON_ERR_EN high and rising edge of INT_SPKMON_ERR_RAW since last INT_SPKMON_ERR_CLR.

BITFIELD	BITS	DESCRIPTION	DECODE
INT_CLK_ERR_FLAG	4	Internal Clock Monitor Error Event Maskable Interrupt Flag. Masked by INT_CLK_ERR_EN and cleared by INT_CLK_ERR_CLR. If IRQ is enabled, an interrupt is generated on a flag bit rising edge.	0: No rising edge of INT_CLK_ERR_RAW since last INT_CLK_ERR_CLR or INT_CLK_ERR_EN is low. 1: INT_CLK_ERR_EN high and rising edge of INT_CLK_ERR_RAW since last INT_CLK_ERR_CLR.
CLK_RECOVER_FLAG	2	PCM Input Clock Error Recovery Event Maskable Interrupt Flag. Masked by CLK_RECOVER_EN and cleared by CLK_RECOVER_CLR. If IRQ is enabled, an interrupt is generated on a flag bit rising edge.	0: No rising edge of CLK_RECOVER_RAW since last CLK_RECOVER_CLR or CLK_RECOVER_EN is low. 1: BCLK_RECOVER_EN high and rising edge of BCLK_RECOVER_RAW since last BCLK_RECOVER_CLR.
CLK_ERR_FLAG	1	PCM Input Clock Error Event Maskable Interrupt Flag. Masked by CLK_ERR_EN and cleared by CLK_ERR_CLR. If IRQ is enabled, an interrupt is generated on a flag bit rising edge.	0: No rising edge of CLK_ERR_RAW since last CLK_ERR_CLR or CLK_ERR_EN is low. 1: CLK_ERR_EN high and rising edge of CLK_ERR_RAW since last CLK_ERR_CLR.
DMON_ERR_FLAG	0	PCM Data Input Error Event Maskable Interrupt Flag. Masked by DMON_ERR_EN and cleared by DMON_ERR_CLR. If IRQ is enabled, an interrupt is generated on a flag bit rising edge.	0: No rising edge of DMON_ERR_RAW since last DMON_ERR_CLR or DMON_ERR_EN is low. 1: DMON_ERR_EN high and rising edge of DMON_ERR_RAW since last DMON_ERR_CLR.

Interrupt Flag 3 (0x200D)

BIT	7	6	5	4	3	2	1	0
Field	AVDD_UVLO_FLAG	DVDD_UVLO_FLAG	PWRUP_DONE_FLAG	PWRDN_DONE_FLAG	PVDD_UVLO_SHDN_FLAG	VBAT_UVLO_SHDN_FLAG	DHT_ACTIVE_BGN_FLAG	DHT_ACTIVE_END_FLAG
Reset	0b0	0b0	0b0	0b0	0b0	0b0	0b0	0b0
Access Type	Read Only	Read Only	Read Only	Read Only	Read Only	Read Only	Read Only	Read Only

BITFIELD	BITS	DESCRIPTION	DECODE
AVDD_UVLO_FLAG	7	AVDD Supply UVLO Event Maskable Interrupt Flag. Masked by AVDD_UVLO_EN and cleared by AVDD_UVLO_CLR. If IRQ is enabled, an interrupt is generated on a flag bit rising edge.	0: No rising edge of AVDD_UVLO_RAW since last AVDD_UVLO_CLR or AVDD_UVLO_EN is low. 1: AVDD_UVLO_EN is high and rising edge of AVDD_UVLO_RAW since last AVDD_UVLO_CLR.
DVDD_UVLO_FLAG	6	DVDD Supply UVLO Event Maskable Interrupt Flag. Masked by DVDD_UVLO_EN and cleared by DVDD_UVLO_CLR. If IRQ is enabled, an interrupt is generated on a flag bit rising edge.	0: No rising edge of DVDD_UVLO_RAW since last DVDD_UVLO_CLR or DVDD_UVLO_EN is low. 1: DVDD_UVLO_EN is high and rising edge of DVDD_UVLO_RAW since last DVDD_UVLO_CLR.
PWRUP_DONE_FLAG	5	Device Power-Up Done Event Maskable Interrupt Flag. Masked by PWRUP_DONE_EN and cleared by PWRUP_DONE_CLR. If IRQ is enabled, an interrupt is generated on a flag bit rising edge.	0: No rising edge of PWRUP_DONE_RAW since last PWRUP_DONE_CLR or PWRUP_DONE_EN is low. 1: PWRUP_DONE_EN is high and rising edge of PWRUP_DONE_RAW since last PWRUP_DONE_CLR.

BITFIELD	BITS	DESCRIPTION	DECODE
PWRDN_DONE_FLAG	4	Device Power-Down Done Event Maskable Interrupt Flag. Masked by PWRDN_DONE_EN and cleared by PWRDN_DONE_CLR. If IRQ is enabled, an interrupt is generated on a flag bit rising edge.	0: No rising edge of PWRDN_DONE_RAW since last PWRDN_DONE_CLR or PWRDN_DONE_EN is low. 1: PWRDN_DONE_EN is high and rising edge of PWRDN_DONE_RAW since last PWRDN_DONE_CLR.
PVDD_UVLO_SHDN_FLAG	3	PVDD Supply UVLO Event Maskable Interrupt Flag. Masked by PVDD_UVLO_SHDN_EN and cleared by PVDD_UVLO_SHDN_CLR. If IRQ is enabled, an interrupt is generated on a flag bit rising edge.	0: No rising edge of PVDD_UVLO_SHDN_RAW since last PVDD_UVLO_SHDN_CLR or PVDD_UVLO_SHDN_EN is low. 1: PVDD_UVLO_SHDN_EN is high and rising edge of PVDD_UVLO_SHDN_RAW since last PVDD_UVLO_SHDN_CLR.
VBAT_UVLO_SHDN_FLAG	2	VBAT supply UVLO Event Maskable Interrupt Flag. Masked by VBAT_UVLO_SHDN_EN and cleared by VBAT_UVLO_SHDN_CLR. If IRQ is enabled, an interrupt is generated on a flag bit rising edge.	0: No rising edge of VBAT_UVLO_SHDN_RAW since last VBAT_UVLO_SHDN_CLR or VBAT_UVLO_SHDN_EN is low. 1: VBAT_UVLO_SHDN_EN is high and rising edge of VBAT_UVLO_SHDN_RAW since last VBAT_UVLO_SHDN_CLR.
DHT_ACTIVE_BGN_FLAG	1	DHT Active Begin Event Maskable Interrupt Flag. Masked by DHT_ACTIVE_BGN_EN and cleared by DHT_ACTIVE_BGN_CLR. If IRQ is enabled, an interrupt is generated on a flag bit rising edge.	0: No rising edge of DHT_ACTIVE_BGN_RAW since last DHT_ACTIVE_BGN_CLR or DHT_ACTIVE_BGN_EN is low. 1: DHT_ACTIVE_BGN_EN is high and rising edge of DHT_ACTIVE_BGN_RAW since last DHT_ACTIVE_BGN_CLR.
DHT_ACTIVE_END_FLAG	0	DHT Active End Event Maskable Interrupt Flag. Masked by DHT_ACTIVE_END_EN and cleared by DHT_ACTIVE_END_CLR. If IRQ is enabled, an interrupt is generated on a flag bit rising edge.	0: No rising edge of DHT_ACTIVE_END_RAW since last DHT_ACTIVE_END_CLR or DHT_ACTIVE_END_EN is low. 1: DHT_ACTIVE_END_EN is high and rising edge of DHT_ACTIVE_END_RAW since last DHT_ACTIVE_END_CLR.

Interrupt Flag 4 (0x200E)

BIT	7	6	5	4	3	2	1	0
Field	–	–	–	–	BPE_L0_FLAG	BPE_LEVEL_FLAG	BPE_ACTIVE_BGN_FLAG	BPE_ACTIVE_END_FLAG
Reset	–	–	–	–	0x0	0x0	0x0	0x0
Access Type	–	–	–	–	Read Only	Read Only	Read Only	Read Only

BITFIELD	BITS	DESCRIPTION	DECODE
BPE_L0_FLAG	3	Brownout-Protection Engine Level 0 Entry Event Maskable Interrupt Flag. Masked by BPE_L0_EN and cleared by BPE_L0_CLR. If IRQ is enabled, an interrupt is generated on a flag bit rising edge.	0: No rising edge of BPE_L0_RAW since last BPE_L0_CLR or BPE_L0_EN is low. 1: BPE_L0_EN high and rising edge of BPE_L0_RAW since last BPE_L0_CLR.
BPE_LEVEL_FLAG	2	Brownout-Protection Engine Level Change Maskable Interrupt Flag. Masked by BPE_LEVEL_EN and cleared by BPE_LEVEL_CLR. If IRQ is enabled, an interrupt is generated on a flag bit rising edge.	0: No rising edge of BPE_LEVEL_RAW since last BPE_LEVEL_CLR or BPE_LEVEL_EN is low. 1: BPE_LEVEL_EN high and rising edge of BPE_LEVEL_RAW since last BPE_LEVEL_CLR.

BITFIELD	BITS	DESCRIPTION	DECODE
BPE_ACTIVE_BGN_FLAG	1	Brownout-Protection Engine Active End Maskable Interrupt Flag. Masked by BPE_ACTIVE_BGN_EN and cleared by BPE_ACTIVE_BGN_CLR. If IRQ is enabled, an interrupt is generated on a flag bit rising edge.	0: No rising edge of BPE_ACTIVE_BGN_RAW since last BPE_ACTIVE_BGN_CLR or BPE_ACTIVE_BGN_EN is low. 1: BPE_ACTIVE_BGN_EN high and rising edge of BPE_ACTIVE_BGN_RAW since last BPE_ACTIVE_BGN_CLR.
BPE_ACTIVE_END_FLAG	0	Brownout-Protection Engine Active End Maskable Interrupt Flag. Masked by BPE_ACTIVE_END_EN and cleared by BPE_ACTIVE_END_CLR. If IRQ is enabled, an interrupt is generated on a flag bit rising edge.	0: No rising edge of BPE_ACTIVE_END_RAW since last BPE_ACTIVE_END_CLR or BPE_ACTIVE_END_EN is low. 1: BPE_ACTIVE_END_EN high and rising edge of BPE_ACTIVE_END_RAW since last BPE_ACTIVE_END_CLR.

Interrupt Enable 1 (0x2010)

BIT	7	6	5	4	3	2	1	0
Field	THERMSHDN_BGN_EN	THERMSHDN_END_EN	THERMWAR N1_BGN_EN	THERMWAR N1_END_EN	THERMFB_BGN_EN	THERMFB_END_EN	OTP_FAIL_EN	SPK_OVC_EN
Reset	0b0	0b0	0b0	0b0	0b0	0b0	0b1	0b0
Access Type	Write, Read	Write, Read	Write, Read	Write, Read	Write, Read	Write, Read	Write, Read	Write, Read

BITFIELD	BITS	DESCRIPTION	DECODE
THERMSHDN_BGN_EN	7	Enable (unmask) control for THERMSHDN_BGN_FLAG.	0: THERMSHDN_BGN_FLAG cannot go high. 1: THERMSHDN_BGN_FLAG goes high if there is a rising edge on THERMSHDN_BGN_RAW since last THERMSHDN_BGN_CLR.
THERMSHDN_END_EN	6	Enable (unmask) control for THERMSHDN_END_FLAG.	0: THERMSHDN_END_FLAG cannot go high. 1: THERMSHDN_END_FLAG goes high if there is a rising edge on THERMSHDN_END_RAW since last THERMSHDN_END_CLR.
THERMWAR N1_BGN_EN	5	Enable (unmask) control for THERMWAR N1_BGN_FLAG.	0: THERMWAR N1_BGN_FLAG cannot go high. 1: THERMWAR N1_BGN_FLAG goes high if there is a rising edge on THERMWAR N1_BGN_RAW since last THERMWAR N1_BGN_CLR.
THERMWAR N1_END_EN	4	Enable (unmask) control for THERMWAR N1_END_FLAG.	0: THERMWAR N1_END_FLAG cannot go high. 1: THERMWAR N1_END_FLAG goes high if there is a rising edge on THERMWAR N1_END_RAW since last THERMWAR N1_END_CLR.
THERMFB_BGN_EN	3	Enable (unmask) control for THERMFB_BGN_FLAG.	0: THERMFB_BGN_FLAG cannot go high. 1: THERMFB_BGN_FLAG goes high if there is a rising edge on THERMFB_BGN_RAW since last THERMFB_BGN_CLR.
THERMFB_END_EN	2	Enable (unmask) control for THERMFB_END_FLAG.	0: THERMFB_END_FLAG cannot go high. 1: THERMFB_END_FLAG goes high if there is a rising edge on THERMFB_END_RAW since last THERMFB_END_CLR.
OTP_FAIL_EN	1	Enable (unmask) control for OTP_FAIL_FLAG.	0: OTP_FAIL_FLAG cannot go high. 1: OTP_FAIL_FLAG goes high if there is a rising edge on OTP_FAIL_RAW since last OTP_FAIL_CLR.

BITFIELD	BITS	DESCRIPTION	DECODE
SPK_OVC_EN	0	Enable (unmask) control for SPK_OVC_FLAG.	0: SPK_OVC_FLAG cannot go high. 1: SPK_OVC_FLAG goes high if there is a rising edge on SPK_OVC_RAW since last SPK_OVC_CLR.

Interrupt Enable 2 (0x2011)

BIT	7	6	5	4	3	2	1	0
Field	THERMWARN2_BGN_EN	THERMWARN2_END_EN	INT_SPKMON_ERR_EN	INT_CLK_ERR_EN	–	CLK_RECOVER_EN	CLK_ERR_EN	DMON_ERR_EN
Reset	0b0	0b0	0b0	0x0	–	0x0	0x0	0b0
Access Type	Write, Read	Write, Read	Write, Read	Write, Read	–	Write, Read	Write, Read	Write, Read

BITFIELD	BITS	DESCRIPTION	DECODE
THERMWARN2_BGN_EN	7	Enable (unmask) control for THERMWARN2_BGN_FLAG.	0: THERMWARN2_BGN_FLAG cannot go high. 1: THERMWARN2_BGN_FLAG goes high if there is a rising edge on THERMWARN2_BGN_RAW since last THERMWARN2_BGN_CLR.
THERMWARN2_END_EN	6	Enable (unmask) control for THERMWARN2_END_FLAG.	0: THERMWARN2_END_FLAG cannot go high. 1: THERMWARN2_END_FLAG goes high if there is a rising edge on THERMWARN2_END_RAW since last THERMWARN2_END_CLR.
INT_SPKMON_ERR_EN	5	Enable (unmask) control for INT_SPKMON_ERR_FLAG.	0: INT_SPKMON_ERR_FLAG cannot go high. 1: INT_SPKMON_ERR_FLAG goes high if there is a rising edge on INT_SPKMON_ERR_RAW since last INT_SPKMON_ERR_CLR.
INT_CLK_ERR_EN	4	Enable (unmask) control for INT_CLK_ERR_FLAG.	0: INT_CLK_ERR_FLAG cannot go high. 1: INT_CLK_ERR_FLAG goes high if there is a rising edge on INT_CLK_ERR_RAW since last INT_CLK_ERR_CLR.
CLK_RECOVER_EN	2	Enable (unmask) control for CLK_RECOVER_FLAG.	0: CLK_RECOVER_FLAG cannot go high. 1: CLK_RECOVER_FLAG goes high if there is a rising edge on CLK_RECOVER_RAW since last CLK_RECOVER_CLR.
CLK_ERR_EN	1	Enable (unmask) control for CLK_ERR_FLAG.	0: CLK_ERR_FLAG cannot go high. 1: CLK_ERR_FLAG goes high if there is a rising edge on CLK_ERR_RAW since last CLK_ERR_CLR.
DMON_ERR_EN	0	Enable (unmask) control for DMON_ERR_FLAG.	0: DMON_ERR_FLAG cannot go high. 1: DMON_ERR_FLAG goes high if there is a rising edge on DMON_ERR_RAW since last DMON_ERR_CLR.

[Interrupt Enable 3 \(0x2012\)](#)

BIT	7	6	5	4	3	2	1	0
Field	AVDD_UVLO_EN	DVDD_UVLO_EN	PWRUP_DONE_EN	PWRDN_DONE_EN	PVDD_UVLO_SHDN_EN	VBAT_UVLO_SHDN_EN	DHT_ACTIVE_BGN_EN	DHT_ACTIVE_END_EN
Reset	0b0	0b0	0b0	0b0	0b0	0b0	0b0	0b0
Access Type	Write, Read	Write, Read	Write, Read	Write, Read	Write, Read	Write, Read	Write, Read	Write, Read

BITFIELD	BITS	DESCRIPTION	DECODE
AVDD_UVLO_EN	7	Enable (unmask) control for AVDD_UVLO_FLAG.	0: AVDD_UVLO_FLAG cannot go high. 1: AVDD_UVLO_FLAG goes high if there is a rising edge on AVDD_UVLO_RAW since last AVDD_UVLO_CLR.
DVDD_UVLO_EN	6	Enable (unmask) control for DVDD_UVLO_FLAG.	0: DVDD_UVLO_FLAG cannot go high. 1: DVDD_UVLO_FLAG goes high if there is a rising edge on DVDD_UVLO_RAW since last DVDD_UVLO_CLR.
PWRUP_DONE_EN	5	Enable (unmask) control for PWRUP_DONE_FLAG.	0: PWRUP_DONE_FLAG cannot go high. 1: PWRUP_DONE_FLAG goes high if there is a rising edge on PWRUP_DONE_RAW since last PWRUP_DONE_CLR.
PWRDN_DONE_EN	4	Enable (unmask) control for PWRDN_DONE_FLAG.	0: PWRDN_DONE_FLAG cannot go high. 1: PWRDN_DONE_FLAG goes high if there is a rising edge on PWRDN_DONE_RAW since last PWRDN_DONE_CLR.
PVDD_UVLO_SHDN_EN	3	Enable (unmask) control for PVDD_UVLO_SHDN_FLAG.	0: PVDD_UVLO_SHDN_FLAG cannot go high. 1: PVDD_UVLO_SHDN_FLAG goes high if there is a rising edge on PVDD_UVLO_SHDN_RAW since last PVDD_UVLO_SHDN_CLR.
VBAT_UVLO_SHDN_EN	2	Enable (unmask) control for VBAT_UVLO_SHDN_FLAG.	0: VBAT_UVLO_SHDN_FLAG cannot go high. 1: VBAT_UVLO_SHDN_FLAG goes high if there is a rising edge on VBAT_UVLO_SHDN_RAW since last VBAT_UVLO_SHDN_CLR.
DHT_ACTIVE_BGN_EN	1	Enable (unmask) control for DHT_ACTIVE_BGN_FLAG.	0: DHT_ACTIVE_BGN_FLAG cannot go high. 1: DHT_ACTIVE_BGN_FLAG goes high if there is a rising edge on DHT_ACTIVE_BGN_RAW since last DHT_ACTIVE_BGN_CLR.
DHT_ACTIVE_END_EN	0	Enable (unmask) control for DHT_ACTIVE_END_FLAG.	0: DHT_ACTIVE_END_FLAG cannot go high. 1: DHT_ACTIVE_END_FLAG goes high if there is a rising edge on DHT_ACTIVE_END_RAW since last DHT_ACTIVE_END_CLR.

[Interrupt Enable 4 \(0x2013\)](#)

BIT	7	6	5	4	3	2	1	0
Field	–	–	–	–	BPE_LO_EN	BPE_LEVEL_EN	BPE_ACTIVE_BGN_EN	BPE_ACTIVE_END_EN
Reset	–	–	–	–	0x0	0x0	0x0	0x0
Access Type	–	–	–	–	Write, Read	Write, Read	Write, Read	Write, Read

BITFIELD	BITS	DESCRIPTION	DECODE
BPE_L0_EN	3	Enable (unmask) control for BPE_L0_FLAG.	0: BPE_L0_FLAG cannot go high. 1: BPE_L0_FLAG goes high if there is a rising edge on BPE_L0_RAW since last BPE_L0_CLR.
BPE_LEVEL_EN	2	Enable (unmask) control for BPE_LEVEL_FLAG.	0: BPE_LEVEL_FLAG cannot go high. 1: BPE_LEVEL_FLAG goes high if there is a rising edge on BPE_LEVEL_RAW since last BPE_LEVEL_CLR.
BPE_ACTIVE_BGN_EN	1	Enable (unmask) control for BPE_ACTIVE_BGN_FLAG.	0: BPE_ACTIVE_BGN_FLAG cannot go high. 1: BPE_ACTIVE_BGN_FLAG goes high if there is a rising edge on BPE_ACTIVE_BGN_RAW since last BPE_ACTIVE_BGN_CLR.
BPE_ACTIVE_END_EN	0	Enable (unmask) control for BPE_ACTIVE_END_FLAG.	0: BPE_ACTIVE_END_FLAG cannot go high. 1: BPE_ACTIVE_END_FLAG goes high if there is a rising edge on BPE_ACTIVE_END_RAW since last BPE_ACTIVE_END_CLR.

Interrupt Flag Clear 1 (0x2015)

BIT	7	6	5	4	3	2	1	0
Field	THERMSHDN_BGN_CLR	THERMSHDN_END_CLR	THERMWAR N1_BGN_CLR	THERMWAR N1_END_CLR	THERMFB_BGN_CLR	THERMFB_END_CLR	OTP_FAIL_CLR	SPK_OVC_CLR
Reset	0b0	0b0	0b0	0b0	0b0	0b0	0b0	0b0
Access Type	Write Only	Write Only	Write Only	Write Only	Write Only	Write Only	Write Only	Write Only

BITFIELD	BITS	DESCRIPTION	DECODE
THERMSHDN_BGN_CLR	7	Clears associated FLAG and STATE bits.	0: Writing zero has no effect. 1: Writing one clears THERMSHDN_BGN_STATE and THERMSHDN_BGN_FLAG to zero.
THERMSHDN_END_CLR	6	Clears associated FLAG and STATE bits.	0: Writing zero has no effect. 1: Writing one clears THERMSHDN_END_STATE and THERMSHDN_END_FLAG to zero.
THERMWAR N1_BGN_CLR	5	Clears associated FLAG and STATE bits.	0: Writing zero has no effect. 1: Writing one clears THERMWAR N1_BGN_STATE and THERMWAR N1_BGN_FLAG to zero.
THERMWAR N1_END_CLR	4	Clears associated FLAG and STATE bits.	0: Writing zero has no effect. 1: Writing one clears THERMWAR N1_END_STATE and THERMWAR N1_END_FLAG to zero.
THERMFB_BGN_CLR	3	Clears associated FLAG and STATE bits.	0: Writing zero has no effect. 1: Writing one clears THERMFB_BGN_STATE and THERMFB_BGN_FLAG to zero.
THERMFB_END_CLR	2	Clears associated FLAG and STATE bits.	0: Writing zero has no effect. 1: Writing one clears THERMFB_END_STATE and THERMFB_END_FLAG to zero.
OTP_FAIL_CLR	1	Clears associated FLAG and STATE bits.	0: Writing zero has no effect. 1: Writing one clears OTP_FAIL_STATE and OTP_FAIL_FLAG to zero.
SPK_OVC_CLR	0	Clears associated FLAG and STATE bits.	0: Writing zero has no effect. 1: Writing one clears SPK_OVC_STATE and SPK_OVC_FLAG to zero.

[Interrupt Flag Clear 2 \(0x2016\)](#)

BIT	7	6	5	4	3	2	1	0
Field	THERMWAR N2_BGN_ CLR	THERMWAR N2_END_ CLR	INT_SPKM ON_ERR_C LR	INT_CLK_E RR_CLR	–	CLK_RECO VER_CLR	CLK_ERR_ CLR	DMON_ER R_CLR
Reset	0b0	0b0	0b0	0x0	–	0x0	0x0	0b0
Access Type	Write Only	Write Only	Write Only	Write Only	–	Write Only	Write Only	Write Only

BITFIELD	BITS	DESCRIPTION	DECODE
THERMWAR N2_BGN_ CLR	7	Clears associated FLAG and STATE bits.	0: Writing zero has no effect. 1: Writing one clears THERMWAR _{N2_BGN_STATE} and THERMWAR _{N2_BGN_FLAG} to zero.
THERMWAR N2_END_ CLR	6	Clears associated FLAG and STATE bits.	0: Writing zero has no effect. 1: Writing one clears THERMWAR _{N2_END_STATE} and THERMWAR _{N2_END_FLAG} to zero.
INT_SPKMO N_ERR_CLR	5	Clears associated FLAG and STATE bits.	0: Writing zero has no effect. 1: Writing one clears INT_SPKMON_ERR_STATE and INT_SPKMON_ERR_FLAG to zero.
INT_CLK_ER R_CLR	4	Clears associated FLAG and STATE bits.	0: Writing zero has no effect. 1: Writing one clears INT_CLK_ERR_STATE and INT_CLK_ERR_FLAG to zero.
CLK_RECOV ER_CLR	2	Clears associated FLAG and STATE bits.	0: Writing zero has no effect. 1: Writing one clears CLK_RECOVER_STATE and CLK_RECOVER_FLAG to zero.
CLK_ERR_C LR	1	Clears associated FLAG and STATE bits.	0: Writing zero has no effect. 1: Writing one clears CLK_ERR_STATE and CLK_ERR_FLAG to zero.
DMON_ERR_ CLR	0	Clears associated FLAG and STATE bits.	0: Writing zero has no effect. 1: Writing one clears DMON_ERR_STATE and DMON_ERR_FLAG to zero.

[Interrupt Flag Clear 3 \(0x2017\)](#)

BIT	7	6	5	4	3	2	1	0
Field	AVDD_UVL O_CLR	DVDD_UVL O_CLR	PWRUP_D ONE_CLR	PWRDN_D ONE_CLR	PVDD_UVL O_SHDN_C LR	VBAT_UVL O_SHDN_C LR	DHT_ACTI VE_BGN_C LR	DHT_ACTI VE_END_C LR
Reset	0b0	0b0	0b0	0b0	0b0	0b0	0b0	0b0
Access Type	Write Only	Write Only	Write Only	Write Only	Write Only	Write Only	Write Only	Write Only

BITFIELD	BITS	DESCRIPTION	DECODE
AVDD_UVLO CLR	7	Clears associated FLAG and STATE bits.	0: Writing zero has no effect. 1: Writing one clears AVDD_UVLO_STATE and AVDD_UVLO_FLAG to zero.
DVDD_UVL O_CLR	6	Clears associated FLAG and STATE bits.	0: Writing zero has no effect. 1: Writing one clears DVDD_UVLO_STATE and DVDD_UVLO_FLAG to zero.

BITFIELD	BITS	DESCRIPTION	DECODE
PWRUP_DONE_CLR	5	Clears associated FLAG and STATE bits.	0: Writing zero has no effect. 1: Writing one clears PWRUP_DONE_STATE and PWRUP_DONE_FLAG to zero.
PWRDN_DONE_CLR	4	Clears associated FLAG and STATE bits.	0: Writing zero has no effect. 1: Writing one clears PWRDN_DONE_STATE and PWRDN_DONE_FLAG to zero.
PVDD_UVLO_SHDN_CLR	3	Clears associated FLAG and STATE bits.	0: Writing zero has no effect. 1: Writing one clears PVDD_UVLO_SHDN_STATE and PVDD_UVLO_SHDN_FLAG to zero.
VBAT_UVLO_SHDN_CLR	2	Clears associated FLAG and STATE bits.	0: Writing zero has no effect. 1: Writing one clears VBAT_UVLO_SHDN_STATE and VBAT_UVLO_SHDN_FLAG to zero.
DHT_ACTIVE_BGN_CLR	1	Clears associated FLAG and STATE bits.	0: Writing zero has no effect. 1: Writing one clears DHT_ACTIVE_BGN_STATE and DHT_ACTIVE_BGN_FLAG to zero.
DHT_ACTIVE_END_CLR	0	Clears associated FLAG and STATE bits.	0: Writing zero has no effect. 1: Writing one clears DHT_ACTIVE_END_STATE and DHT_ACTIVE_END_FLAG to zero.

Interrupt Flag Clear 4 (0x2018)

BIT	7	6	5	4	3	2	1	0
Field	–	–	–	–	BPE_L0_CLR	BPE_LEVEL_CLR	BPE_ACTIVE_BGN_CLR	BPE_ACTIVE_END_CLR
Reset	–	–	–	–	0x0	0x0	0x0	0x0
Access Type	–	–	–	–	Write Only	Write Only	Write Only	Write Only

BITFIELD	BITS	DESCRIPTION	DECODE
BPE_L0_CLR	3	Clears associated FLAG and STATE bits.	0: Writing zero has no effect. 1: Writing one clears BPE_L0_STATE and BPE_L0_FLAG to zero.
BPE_LEVEL_CLR	2	Clears associated FLAG and STATE bits.	0: Writing zero has no effect. 1: Writing one clears BPE_LEVEL_STATE and BPE_LEVEL_FLAG to zero.
BPE_ACTIVE_BGN_CLR	1	Clears associated FLAG and STATE bits.	0: Writing zero has no effect. 1: Writing one clears BPE_ACTIVE_BGN_STATE and BPE_ACTIVE_BGN_FLAG to zero.
BPE_ACTIVE_END_CLR	0	Clears associated FLAG and STATE bits.	0: Writing zero has no effect. 1: Writing one clears BPE_ACTIVE_END_STATE and BPE_ACTIVE_END_FLAG to zero.

IRQ Control (0x201F)

BIT	7	6	5	4	3	2	1	0
Field	–	–	–	–	–	IRQ_MODE	IRQ_POL	IRQ_EN
Reset	–	–	–	–	–	0b0	0b0	0b0
Access Type	–	–	–	–	–	Write, Read	Write, Read	Write, Read

BITFIELD	BITS	DESCRIPTION	DECODE
IRQ_MODE	2	Controls the drive mode of the IRQ output.	0: Open-drain output (An external pullup resistor is required). 1: CMOS push-pull output.
IRQ_POL	1	Controls the IRQ output assert polarity.	0: IRQ output is low when any interrupt FLAG bits are high (i.e., active-low). 1: IRQ output is high when any interrupt FLAG bits are high (i.e., active-high).
IRQ_EN	0	Enables the IRQ Output.	0: IRQ output is disabled and is Hi-Z. 1: IRQ output is enabled and controlled by the interrupt controller.

Thermal Warning Threshold (0x2020)

BIT	7	6	5	4	3	2	1	0
Field	–	THERMWARN1_THRESH[6:0]						
Reset	–	0x46						
Access Type	–	Write, Read						

BITFIELD	BITS	DESCRIPTION	DECODE
THERMWAR N1_THRESH	6:0	Sets the first thermal-warning threshold temperature.	0x00: 50°C 0x01: 51°C 0x02: 52°C ... 0x62: 148°C 0x63: 149°C 0x64-0x7F: 150°C

Warning Threshold 2 (0x2021)

BIT	7	6	5	4	3	2	1	0
Field	–	THERMWARN2_THRESH[6:0]						
Reset	–	0x52						
Access Type	–	Write, Read						

BITFIELD	BITS	DESCRIPTION	DECODE
THERMWAR N2_THRESH	6:0	Sets the second thermal-warning threshold temperature	0x00: 50°C 0x01: 51°C 0x02: 52°C ... 0x62: 148°C 0x63: 149°C 0x64-0x7F: 150°C

Thermal Shutdown Threshold (0x2022)

BIT	7	6	5	4	3	2	1	0
Field	–	THERMSHDN_THRESH[6:0]						
Reset	–	0x64						
Access Type	–	Write, Read						

BITFIELD	BITS	DESCRIPTION	DECODE
THERMSHD N_THRESH	6:0	Sets the thermal-shutdown threshold temperature.	0x00: 50°C 0x01: 51°C 0x02: 52°C ... 0x30: 98°C 0x31: 99°C 0x64 to 0x7F: 150°C

Thermal Hysteresis (0x2023)

BIT	7	6	5	4	3	2	1	0
Field	–	–	–	–	–	–	THERM_HYST[1:0]	
Reset	–	–	–	–	–	–	0x2	
Access Type	–	–	–	–	–	–	Write, Read	

BITFIELD	BITS	DESCRIPTION	DECODE
THERM_HY ST	1:0	Controls the amount of hysteresis applied to the thermal threshold measurements.	0x0: 2°C 0x1: 5°C 0x2: 7°C 0x3: 10°C

Thermal Foldback Settings (0x2024)

BIT	7	6	5	4	3	2	1	0
Field	THERMFB_HOLD[1:0]		THERMFB_RLS[1:0]		THERMFB_SLOPE2[1:0]		THERMFB_SLOPE1[1:0]	
Reset	0x3		0x0		0x2		0x2	
Access Type	Write, Read		Write, Read		Write, Read		Write, Read	

BITFIELD	BITS	DESCRIPTION	DECODE
THERMFB_ HOLD	7:6	The thermal foldback hold time controls how long the device temperature must remain below the configured thermal threshold hysteresis before thermal foldback release begins.	0x0: 0ms 0x1: 20ms 0x2: 40ms 0x3: 80ms
THERMFB_ RLS	5:4	This sets the release rate of the thermal foldback attenuation.	0x0: 3ms/dB 0x1: 10ms/dB 0x2: 100ms/dB 0x3: 300ms/dB
THERMFB_ S LOPE2	3:2	This sets the slope of the thermal foldback attenuation when die temperature exceeds THERMWARN2_THRESH.	0x0: 0.25dB/°C 0x1: 0.5dB/°C 0x2: 1.0dB/°C 0x3: 2.0dB/°C

BITFIELD	BITS	DESCRIPTION	DECODE
THERMFB_S LOPE1	1:0	This sets the slope of the thermal foldback attenuation when the die temperature exceeds the thermal-warning1 threshold (THERMWARN1_THRESH) but is lower than the thermal-warning2 threshold (THERMWARN2_THRESH).	0x0: 0.25dB/°C 0x1: 0.5dB/°C 0x2: 1.0dB/°C 0x3: 2.0dB/°C

Thermal Foldback Enable (0x2027)

BIT	7	6	5	4	3	2	1	0
Field	–	–	–	–	–	–	–	THERMFB_EN
Reset	–	–	–	–	–	–	–	0b1
Access Type	–	–	–	–	–	–	–	Write, Read

BITFIELD	BITS	DESCRIPTION	DECODE
THERMFB_EN	0	Enables Thermal Foldback.	0: Thermal foldback disabled. 1: Thermal foldback enabled.

Noise Gate/Idle Mode Control (0x2030)

BIT	7	6	5	4	3	2	1	0
Field	NG_UNMUTE_THRESH[3:0]				NG_MUTE_THRESH[3:0]			
Reset	0x3				0x2			
Access Type	Write, Read				Write, Read			

BITFIELD	BITS	DESCRIPTION	DECODE
NG_UNMUTE_THRESH	7:4	Sets the threshold (number of LSBs toggling) at which the noise gate/idle mode deactivates.	0x0: 1 LSB 0x1: 2 LSBs 0x2: 3 LSBs 0x3: 4 LSBs 0x4: 5 LSBs 0x5: 6 LSBs 0x6: 7 LSBs 0x7: 8 LSBs 0x8: 9 LSBs 0x9: 10 LSBs 0xA to 0xF: Reserved
NG_MUTE_THRESH	3:0	Sets the threshold (number of LSBs toggling) at which the noise gate/idle mode is activated.	0x0: 1 LSB 0x1: 2 LSBs 0x2: 3 LSBs 0x3: 4 LSBs 0x4: 5 LSBs 0x5: 6 LSBs 0x6: 7 LSBs 0x7: 8 LSBs 0x8: 9 LSBs 0x9: 10 LSBs 0xA to 0xF: Reserved

Noise Gate/Idle Mode Enables (0x2033)

BIT	7	6	5	4	3	2	1	0
Field	–	–	–	–	–	–	IDLE_MOD E_EN	NOISEGAT E_EN
Reset	–	–	–	–	–	–	0x0	0x0
Access Type	–	–	–	–	–	–	Write, Read	Write, Read

BITFIELD	BITS	DESCRIPTION	DECODE
IDLE_MODE _EN	1	Enables the amplifier idle mode. Idle mode cannot be enabled when the noise gate function is also enabled.	0: Idle mode disabled. 1: Idle mode enabled.
NOISEGATE _EN	0	Enables the noise gate.	0: Noise gate disabled. 1: Noise gate enabled.

Clock Monitor Control (0x2038)

BIT	7	6	5	4	3	2	1	0
Field	–	CMON_BSELTOL[2:0]			CMON_ERRTOL[2:0]			CMON_AU TORESTAR T_EN
Reset	–	0b0			0x0			0x0
Access Type	–	Write, Read			Write, Read			Write, Read

BITFIELD	BITS	DESCRIPTION	DECODE
CMON_BSE LTOL	6:4	The number of frames of incorrect or correct clock ratio (BCLKs per LRCLK) needed to trigger or recover from a framing error.	0x0: Trigger after 1 incorrect LRCLK frame, recover after 1 correct LRCLK frame. 0x1: Trigger after 2 incorrect LRCLK frames, recover after 16 correct LRCLK frames. 0x2: Trigger after 3 incorrect LRCLK frames, recover after 24 correct LRCLK frame. 0x3: Trigger after 4 incorrect LRCLK frames, recover after 32 correct LRCLK frames. 0x4: Trigger after 5 incorrect LRCLK frames, recover after 40 correct LRCLK frames. 0x5: Trigger after 6 incorrect LRCLK frames, recover after 48 correct LRCLK frames. 0x6: Trigger after 7 incorrect LRCLK frames, recover after 56 correct LRCLK frames. 0x7: Trigger after 8 incorrect LRCLK frames, recover after 64 correct LRCLK frames.

BITFIELD	BITS	DESCRIPTION	DECODE
CMON_ERR TOL	3:1	Selects the number of incorrect or correct LRCLK periods needed to trigger or recover from a frame clock rate error.	0x0: Trigger after 1 incorrect LRCLK frame, recover after 1 correct LRCLK frame. 0x1: Trigger after 2 incorrect LRCLK frames, recover after 16 correct LRCLK frames. 0x2: Trigger after 3 incorrect LRCLK frames, recover after 24 correct LRCLK frames. 0x3: Trigger after 4 incorrect LRCLK frames, recover after 32 correct LRCLK frames. 0x4: Trigger after 5 incorrect LRCLK frames, recover after 40 correct LRCLK frames. 0x5: Trigger after 6 incorrect LRCLK frames, recover after 48 correct LRCLK frames. 0x6: Trigger after 7 incorrect LRCLK frames, recover after 56 correct LRCLK frames. 0x7: Trigger after 8 incorrect LRCLK frames, recover after 64 correct LRCLK frames.
CMON_AUT ORESTART_ EN	0	Controls whether or not the device automatically resumes playback when the clocks become valid after the device is disabled due to a clock monitor error.	0: Device does not automatically restart after valid clocks are reapplied. 1: Device automatically restarts after valid clocks are reapplied.

Data Monitor Control (0x2039)

BIT	7	6	5	4	3	2	1	0
Field	–	–	DMON_MAG_THRES[1:0]		DMON_STUCK_THRES[1:0]		DMON_DURATION[1:0]	
Reset	–	–	0x0		0x0		0x0	
Access Type	–	–	Write, Read		Write, Read		Write, Read	

BITFIELD	BITS	DESCRIPTION	DECODE
DMON_MAG _THRES	5:4	Sets the data magnitude error threshold that the input PCM amplitude level is compared against. If the input signal is above this threshold for longer than the DMON_DURATION, a data monitor error is asserted.	0x0: -30.1030dB (5 bits) 0x1: -24.0824dB (4 bits) 0x2: -18.0618dB (3 bits) 0x3: -12.0412dB (2 bits)
DMON_STU CK_THRES	3:2	Sets the data stuck error threshold that the input PCM amplitude level is compared against. If the input signal is stuck at the same value above this threshold for longer than the DMON_DURATION, a data monitor error is asserted.	0x0: 15-bits (-90.3090 dBFS) 0x1: 13-bits (-78.2678 dBFS) 0x2: 11-bits (-66.2266 dBFS) 0x3: 9-bits (-54.1854 dBFS)
DMON_DUR ATION	1:0	Sets the time duration over which the data monitor must consecutively detect erroneous input PCM data before asserting a data monitor error.	0x0: 64ms 0x1: 256ms 0x2: 1024ms 0x3: 4096ms

[Speaker Monitor Threshold \(0x203A\)](#)

BIT	7	6	5	4	3	2	1	0
Field	–	–	–	–	SPKMON_THRESH[3:0]			
Reset	–	–	–	–	0x3			
Access Type	–	–	–	–	Write, Read			

BITFIELD	BITS	DESCRIPTION	DECODE
SPKMON_THRESH	3:0	Sets the speaker power threshold. If the signal power recovered by the circuit is above this threshold, the speaker monitor error is asserted. Minimum threshold is 0.25V and maximum is 4V, 0.25V per step.	0x0: 0.25V 0x1: 0.5V: 0.25V per step 0xE: 3.75V 0xF: 4.0V

[Enable Controls \(0x203F\)](#)

BIT	7	6	5	4	3	2	1	0
Field	–	–	–	–	SPKMON_EN	DMON_MAG_EN	DMON_STUCK_EN	CMON_EN
Reset	–	–	–	–	0x1	0x1	0x1	0x1
Access Type	–	–	–	–	Write, Read	Write, Read	Write, Read	Write, Read

BITFIELD	BITS	DESCRIPTION	DECODE
SPKMON_EN	3	Enables the internal speaker protection monitor.	0x0: Disable internal speaker data monitor. 0x1: Enable internal speaker data monitor.
DMON_MAG_EN	2	Enables the data monitor circuit to monitor PCM input data for large magnitude (DC) audio.	0: Data magnitude check disabled. 1: Data magnitude check enabled.
DMON_STUCK_EN	1	Enables the data monitor circuit to monitor PCM input for stuck data.	0: Data stuck-at monitor disabled. 1: Data stuck-at monitor enabled.
CMON_EN	0	Enables the clock monitor to monitor PCM input clocks for clock errors.	0: Clock monitor disabled. 1: Clock monitor enabled.

[Pin Config \(0x2040\)](#)

BIT	7	6	5	4	3	2	1	0
Field	LV_EN_DRV[1:0]		ICC_DRV[1:0]		IRQ_DRV[1:0]		DOUT_DRV[1:0]	
Reset	0x1		0x1		0x1		0x1	
Access Type	Write, Read		Write, Read		Write, Read		Write, Read	

BITFIELD	BITS	DESCRIPTION	DECODE
LV_EN_DRV	7:6	Configures the output drive strength of the LV_EN pin.	0x0: Reduced drive mode. 0x1: Normal drive mode. 0x2: High drive mode. 0x3: Maximum drive mode.
ICC_DRV	5:4	Configures the output drive strength of the ICC pin.	00: Reduced drive mode. 01: Normal drive mode. 10: High drive mode. 11: Maximum drive mode.

BITFIELD	BITS	DESCRIPTION	DECODE
IRQ_DRV	3:2	Configures the output drive strength of the IRQ pin.	00: Reduced drive mode. 01: Normal drive mode. 10: High drive mode. 11: Maximum drive mode.
DOUT_DRV	1:0	Configures the output drive strength of the DOUT pin.	00: Reduced drive mode. 01: Normal drive mode. 10: High drive mode. 11: Maximum drive mode.

PCM Mode Config (0x2041)

BIT	7	6	5	4	3	2	1	0
Field	PCM_CHANSZ[1:0]		PCM_FORMAT[2:0]			PCM_TX_INTERLEAVE	PCM_CHANNELSEL	PCM_TX_EXTRA_HIZ
Reset	0x3		0x0			0x0	0b0	0b0
Access Type	Write, Read		Write, Read			Write, Read	Write, Read	Write, Read

BITFIELD	BITS	DESCRIPTION	DECODE
PCM_CHANSZ	7:6	Configures the PCM data word size for each channel.	00: Reserved 01: 16-bit 10: 24-bit 11: 32-bit
PCM_FORMAT	5:3	Selects the PCM data format.	0x0: I ² S Mode 0x1: Left-justified 0x2: Reserved 0x3: TDM Mode 0 (0 BCLK delay from LRCLK) 0x4: TDM Mode 1 (1 BCLK delay from LRCLK) 0x5: TDM Mode 2 (2 BCLK delay from LRCLK) 0x6 to 0x7: Reserved
PCM_TX_INTERLEAVE	2	Controls whether or not I/V sense data assigned to the same channel is frame interleaved on the PCM data output (DOUT).	0: Disable Interleave mode. 1: Enable Interleave mode.
PCM_CHANNELSEL	1	Selects which LRCLK edge starts a new frame (channel 0 or slot 0).	0: I ² S and LJ mode: Falling LRCLK edge starts a new frame. In TDM modes: Rising LRCLK edge starts a new frame. 1: In I ² S and LJ mode: Rising LRCLK edge starts a new frame. In TDM modes: Falling LRCLK edge starts a new frame.
PCM_TX_EXTRA_HIZ	0	Select whether DOUT is driven to zero or Hi-Z during extra BCLK cycles.	0: Drive DOUT to zero for extra BCLK cycles. 1: Drive DOUT to Hi-Z for extra BCLK cycles.

PCM Clock Setup (0x2042)

BIT	7	6	5	4	3	2	1	0
Field	–	–	–	PCM_BCLK_EDGE	PCM_BSEL[3:0]			
Reset	–	–	–	0b0	0x4			
Access Type	–	–	–	Write, Read	Write, Read			

BITFIELD	BITS	DESCRIPTION	DECODE
PCM_BCLKEDGE	4	Selects the active BCLK edge.	0: Input data captured and output data valid on rising edge of BCLK. 1: Input data captured and output data valid on falling edge of BCLK.
PCM_BSEL	3:0	Selects the number of BCLKs per LRCLK expected by the PCM Interface.	0x0: Reserved 0x1: Reserved 0x2: 32 0x3: 48 0x4: 64 0x5: 96 0x6: 128 0x7: 192 0x8: 256 0x9: 384 0xA: 512 0xB: 320 0xC: 250 0xD: 125 0xE to 0xF: Reserved

PCM Sample Rate Setup 1 (0x2043)

BIT	7	6	5	4	3	2	1	0
Field	IVADC_SR[3:0]				PCM_SR[3:0]			
Reset	0x8				0x8			
Access Type	Write, Read				Write, Read			

BITFIELD	BITS	DESCRIPTION	DECODE
IVADC_SR	7:4	Sets the sample rate of the I/V Sense ADC path.	0x0: 8kHz 0x1: 11.025kHz 0x2: 12kHz 0x3: 16kHz 0x4: 22.05kHz 0x5: 24kHz 0x6: 32kHz 0x7: 44.1kHz 0x8: 48kHz 0x9: 88.2kHz 0xA: 96kHz 0xB: 176.4kHz 0xC: 192kHz 0xD to 0xF: Reserved

BITFIELD	BITS	DESCRIPTION	DECODE
PCM_SR	3:0	Sets the sample rate of the PCM interface. This corresponds to the expected LRCLK frequency.	0x0: 8kHz 0x1: 11.025kHz 0x2: 12kHz 0x3: 16kHz 0x4: 22.05kHz 0x5: 24kHz 0x6: 32kHz 0x7: 44.1kHz 0x8: 48kHz 0x9: 88.2kHz 0xA: 96kHz 0xB: 176.4kHz 0xC: 192kHz 0xD to 0xF: Reserved

PCM TX Control 1 (0x2044)

BIT	7	6	5	4	3	2	1	0
Field	–	–	PCM_VMON_SLOT[5:0]					
Reset	–	–	0x0					
Access Type	–	–	Write, Read					

BITFIELD	BITS	DESCRIPTION	DECODE
PCM_VMON_SLOT	5:0	Selects the data output (DOUT) slots for the voltage sense output data. In non-TDM mode, only Slot 0/1 and Slot 1/2 are valid.	0x0: Slot 00/01 0x1: Slot 01/02 0x2: Slot 02/03 0x22 to 0x3D: ... 0x3E: Slot 62/63 0x3F: Reserved

PCM TX Control 2 (0x2045)

BIT	7	6	5	4	3	2	1	0
Field	–	–	PCM_IMON_SLOT[5:0]					
Reset	–	–	0x0					
Access Type	–	–	Write, Read					

BITFIELD	BITS	DESCRIPTION	DECODE
PCM_IMON_SLOT	5:0	IMON Data Output Slot Select. IMON data requires two slots. In non-TDM mode, only Slot 0/1 and Slot 1/2 are valid.	0x0: Slot 00/01 0x1: Slot 01/02 0x2: Slot 02/03 0x22 to 0x3D: ... 0x3E: Slot 62/63 0x3F: Reserved

[PCM TX Control 3 \(0x2046\)](#)

BIT	7	6	5	4	3	2	1	0
Field	–	–	PCM_SUPPLY1_SLOT[5:0]					
Reset	–	–	0x0					
Access Type	–	–	Write, Read					

BITFIELD	BITS	DESCRIPTION	DECODE
PCM_SUPPL Y1_SLOT	5:0	PCM Slot Select for Supply1 Measurement ADC Data (ADC) Output. Supply1 ADC data requires two slots.	0x0: Slot 00/01 0x1: Slot 01/02 0x2: Slot 02/03 0x22 to 0x3D: ... 0x3E: Slot 62/63 0x3F: Reserved

[PCM TX Control 4 \(0x2047\)](#)

BIT	7	6	5	4	3	2	1	0
Field	–	–	PCM_SUPPLY2_SLOT[5:0]					
Reset	–	–	0x0					
Access Type	–	–	Write, Read					

BITFIELD	BITS	DESCRIPTION	DECODE
PCM_SUPPL Y2_SLOT	5:0	PCM Slot Select for Supply2 Measurement ADC Data (ADC) Output. Supply2 ADC data requires two slots.	0x0: Slot 00/01 0x1: Slot 01/02 0x2: Slot 02/03 0x22 to 0x3D: ... 0x3E: Slot 62/63 0x3F: Reserved

[PCM TX Control 5 \(0x2048\)](#)

BIT	7	6	5	4	3	2	1	0
Field	–	–	PCM_DHT_ATN_SLOT[5:0]					
Reset	–	–	0x0					
Access Type	–	–	Write, Read					

BITFIELD	BITS	DESCRIPTION	DECODE
PCM_DHT_A TN_SLOT	5:0	DHT Attenuation Data Output Slot Select. DHT Attenuation data requires two slots.	0x0: Slot 00/01 0x1: Slot 01/02 0x2: Slot 02/03 0x22 to 0x3D: ... 0x3E: Slot 62/63 0x3F: Reserved

[PCM TX Control 6 \(0x2049\)](#)

BIT	7	6	5	4	3	2	1	0
Field	–	–	PCM_STATUS_SLOT[5:0]					
Reset	–	–	0x0					
Access Type	–	–	Write, Read					

BITFIELD	BITS	DESCRIPTION	DECODE
PCM_STATUS_SLOT	5:0	Device Status Data Output Slot Select. Device status requires two slots.	0x00: Slot 00/01 0x01: Slot 01/02 0x02 to 0x3D: 0x3E: Slot 62/63 0x3F: Reserved

[PCM TX Control 7 \(0x204A\)](#)

BIT	7	6	5	4	3	2	1	0
Field	–	–	PCM_DSP_MONITOR_SLOT[5:0]					
Reset	–	–	0x0					
Access Type	–	–	Write, Read					

BITFIELD	BITS	DESCRIPTION	DECODE
PCM_DSP_MONITOR_SLOT	5:0	DSP Monitor Data Output Slot Select. DSP monitor data requires 4 slots.	0x0: Slot 00/01/02/03 0x1: Slot 01/02/03/04 0x2: Slot 02/03/04/05 0x3 to 0x3B: 0x3C: Slot 60/61/62/63 0x3D: Reserved 0x3E: Reserved 0x3F: Reserved

[PCM TX Control 8 \(0x204B\)](#)

BIT	7	6	5	4	3	2	1	0
Field	–	–	PCM_BPE_SLOT[5:0]					
Reset	–	–	0x0					
Access Type	–	–	Write, Read					

BITFIELD	BITS	DESCRIPTION	DECODE
PCM_BPE_SLOT	5:0	BPE State Output Slot Select. BPE state requires one slot.	0x0: Slot 00 0x1: Slot 01 0x2: Slot 02 0x22 to 0x3D: ... 0x3E: Slot 62 0x3F: Slot 62

PCM TX Control 9 (0x204C)

BIT	7	6	5	4	3	2	1	0
Field	–	–	PCM_THERM_SLOT[5:0]					
Reset	–	–	0x0					
Access Type	–	–	Write, Read					

BITFIELD	BITS	DESCRIPTION	DECODE
PCM_THERM_SLOT	5:0	PCM Slot Select for Thermal Measurement ADC Data (ADC) Output. Thermal ADC data requires two slots.	0x0: Slot 00/01 0x1: Slot 01/02 0x2: Slot 02/03 0x22 to 0x3D: ... 0x3E: Slot 62/63 0x3F: Reserved

PCM TX Control 10 (0x204D)

BIT	7	6	5	4	3	2	1	0
Field	–	–	PCM_ICC_SLOT[5:0]					
Reset	–	–	0x0					
Access Type	–	–	Write, Read					

BITFIELD	BITS	DESCRIPTION	DECODE
PCM_ICC_SLOT	5:0	<p>Selects the data output (DOUT) slots for the ICC output data.</p> <p>In non-TDM mode, only Slot 00/01 and Slot 01/02 are valid. If IV_{SENSE} is enabled, ICC over DOUT only works when PCM_CHANSZ is set to 32 bits, PCM_TX_INTERLEAVE is enabled, and PCM_ICC_SLOT is set to the same as PCM_VMON_SLOT.</p> <p>In TDM mode, the ICC needs 3 slots. PCM_CHANSZ has to be greater than 16 bits, and the PCM_ICC_SLOT has to set in a number that is shown below: If PCM_CHANSZ = 24 bits, then PCM_ICC_SLOT is divisible by 3. If PCM_CHANSZ = 32 bits, then PCM_ICC_SLOT is divisible by 4.</p>	0x0: Slot 00/01 0x1: Slot 01/02 0x2: Slot 02/03 0x22 to 0x3D: ... 0x3E: Slot 62/63 0x3F: Reserved

PCM Tx HiZ Control 1 (0x204E)

BIT	7	6	5	4	3	2	1	0
Field	PCM_TX_SLOT_HI_Z[63:56]							
Reset	0xFF							
Access Type	Write, Read							

BITFIELD	BITS	DESCRIPTION	DECODE
PCM_TX_SL OT_HIZ	7:0	Configures the unused PCM data output slots to transmit either Hi-Z or 0.	Value: Decode 0: Output 0 on idle slots from 63 to 56. 1: Output Hi-Z on slots from 63 to 56.

PCM Tx HiZ Control 2 (0x204F)

BIT	7	6	5	4	3	2	1	0
Field	PCM_TX_SLOT_HIZ[55:48]							
Reset	0xFF							
Access Type	Write, Read							

BITFIELD	BITS	DESCRIPTION	DECODE
PCM_TX_SL OT_HIZ	7:0	Configures the unused PCM slots to set them to Hi-Z or 0.	0: Output 0 on idle slots from 55 to 48. 1: Output Hi-Z on slots from 55 to 48.

PCM Tx HiZ Control 3 (0x2050)

BIT	7	6	5	4	3	2	1	0
Field	PCM_TX_SLOT_HIZ[47:40]							
Reset	0xFF							
Access Type	Write, Read							

BITFIELD	BITS	DESCRIPTION	DECODE
PCM_TX_SL OT_HIZ	7:0	Configures the unused PCM slots to set them all to Hi-Z or 0.	0: Output 0 on idle slots from 47 to 40. 1: Output Hi-Z on slots from 47 to 40.

PCM Tx HiZ Control 4 (0x2051)

BIT	7	6	5	4	3	2	1	0
Field	PCM_TX_SLOT_HIZ[39:32]							
Reset	0xFF							
Access Type	Write, Read							

BITFIELD	BITS	DESCRIPTION	DECODE
PCM_TX_SL OT_HIZ	7:0	Configures the unused PCM slots to set them all to Hi-Z or 0.	0: Output 0 on idle slots from 39 to 32. 1: Output Hi-Z on slots from 39 to 32.

PCM Tx HiZ Control 5 (0x2052)

BIT	7	6	5	4	3	2	1	0
Field	PCM_TX_SLOT_HIZ[31:24]							
Reset	0xFF							
Access Type	Write, Read							

BITFIELD	BITS	DESCRIPTION	DECODE
PCM_TX_SL OT_HIZ	7:0	Configures the unused PCM slots to set them all to Hi-Z or 0.	0: Output 0 on slots from 31 to 24. 1: Output Hi-Z on idle slots from 31 to 24.

PCM Tx HiZ Control 6 (0x2053)

BIT	7	6	5	4	3	2	1	0
Field	PCM_TX_SLOT_HIZ[23:16]							
Reset	0xFF							
Access Type	Write, Read							

BITFIELD	BITS	DESCRIPTION	DECODE
PCM_TX_SL OT_HIZ	7:0	Configures the unused PCM slots to set them all to Hi-Z or 0.	0: Output 0 on idle slots from 23 to 16. 1: Output Hi-Z on slots from 23 to 16.

PCM Tx HiZ Control 7 (0x2054)

BIT	7	6	5	4	3	2	1	0
Field	PCM_TX_SLOT_HIZ[15:8]							
Reset	0xFF							
Access Type	Write, Read							

BITFIELD	BITS	DESCRIPTION	DECODE
PCM_TX_SL OT_HIZ	7:0	Configures the unused PCM slots to set them all to Hi-Z or 0.	0: Output 0 on slots from 15 to 8. 1: Output Hi-Z on idle slots from 15 to 8.

PCM Tx HiZ Control 8 (0x2055)

BIT	7	6	5	4	3	2	1	0
Field	PCM_TX_SLOT_HIZ[7:0]							
Reset	0xFF							
Access Type	Write, Read							

BITFIELD	BITS	DESCRIPTION	DECODE
PCM_TX_SL OT_HIZ	7:0	Configures the unused PCM slots to set them all to Hi-Z or 0.	0: Output 0 on idle slots from 7 to 0. 1: Output Hi-Z on slots from 7 to 0.

PCM RX Source 1 (0x2057)

BIT	7	6	5	4	3	2	1	0
Field	–	–	–	–	–	–	PCM_DMMIX_CFG[1:0]	
Reset	–	–	–	–	–	–	0x0	
Access Type	–	–	–	–	–	–	Write, Read	

BITFIELD	BITS	DESCRIPTION	DECODE
PCM_DMMIX_CFG	1:0	Determines the behavior of the mono mixer circuit.	0x0: Output of monomixer is Channel 0. 0x1: Output of monomixer is Channel 1. 0x2: Output of monomixer is (Channel 0 + Channel 1)/2. 0x3: Reserved

PCM RX Source 2 (0x2058)

BIT	7	6	5	4	3	2	1	0
Field	PCM_DMMIX_CH1_SOURCE[3:0]				PCM_DMMIX_CH0_SOURCE[3:0]			
Reset	0x1				0x0			
Access Type	Write, Read				Write, Read			

BITFIELD	BITS	DESCRIPTION	DECODE
PCM_DMMIX_CH1_SOURCE	7:4	Selects the PCM data input channel that is routed to the channel 1 of the digital mono mixer.	0x0: PCM Input Channel 0 0x1: PCM Input Channel 1 0x2: PCM Input Channel 2 ... 0xE: PCM Input Channel 14 0xF: PCM Input Channel 15
PCM_DMMIX_CH0_SOURCE	3:0	Selects the PCM data input channel that is routed to the channel 0 of the digital mono mixer.	0x0: PCM Input Channel 0 0x1: PCM Input Channel 1 0x2: PCM Input Channel 2 ... 0xE: PCM Input Channel 14 0xF: PCM Input Channel 15

PCM Bypass Source (0x2059)

BIT	7	6	5	4	3	2	1	0
Field	–	–	–	–	PCM_BYPASS_SOURCE[3:0]			
Reset	–	–	–	–	0x0			
Access Type	–	–	–	–	Write, Read			

BITFIELD	BITS	DESCRIPTION	DECODE
PCM_BYPASS_SOURCE	3:0	Selects the PCM data input channel that is routed to the speaker audio processing bypass path.	0x0: PCM Input Channel 0 0x1: PCM Input Channel 1 0x2: PCM Input Channel 2 ... 0xE: PCM Input Channel 14 0xF: PCM Input Channel 15

PCM TX Source Enables (0x205C)

BIT	7	6	5	4	3	2	1	0
Field	PCM_BPE_EN	PCM_STATUS_EN	PCM_DHT_ATN_EN	PCM_SUPPLY2_EN	PCM_SUPPLY1_EN	PCM_DSPMONITOR_EN	PCM_IMON_EN	PCM_VMON_EN
Reset	0x0	0x0	0x0	0x0	0x0	0x0	0x0	0x0
Access Type	Write, Read	Write, Read	Write, Read	Write, Read	Write, Read	Write, Read	Write, Read	Write, Read

BITFIELD	BITS	DESCRIPTION	DECODE
PCM_BPE_EN	7	Enables transmit of the Brownout-Prevention Engine (BPE) state on the assigned data output (DOUT) slot. This output data can be transmitted only in TDM mode.	0: Disable BPE state transmit. 1: Enable BPE state transmit.
PCM_STATUS_EN	6	Enables transmit of the device status on the assigned data output (DOUT) slots. This output data can be transmitted only in TDM mode.	0: Disable device status transmit. 1: Enable device status transmit.
PCM_DHT_ATN_EN	5	Enables transmit of the applied DHT attenuation on the assigned data output (DOUT) slot. This output data can be transmitted only in TDM mode.	0: Disable DHT attenuation data transmit. 1: Enable DHT attenuation data transmit.
PCM_SUPPLY2_EN	4	Enables transmit of the measured VBAT supply voltage on the assigned data output (DOUT) slot. This output data can be transmitted only in TDM mode.	0: Disable VBAT supply voltage data transmit. 1: Enable VBAT supply voltage data transmit.
PCM_SUPPLY1_EN	3	Enables transmit of the measured PVDD supply voltage on the assigned data output (DOUT) slot. This output data can be transmitted only in TDM mode.	0: Disable PVDD supply voltage data transmit. 1: Enable PVDD supply voltage data transmit.
PCM_DSPMONITOR_EN	2	Enables transmit of the playback path DSP output data on the assigned data output (DOUT) slot.	0: Disable playback path data transmit. 1: Enable playback path data transmit.
PCM_IMON_EN	1	Enables transmit of the current sense output data on the assigned data output (DOUT) slot.	0: Disable current sense data transmit. 1: Enable current sense data transmit.
PCM_VMON_EN	0	Enables transmit of the voltage sense output data on the assigned data output (DOUT) slot.	0: Disable voltage sense data transmit. 1: Enable voltage sense data transmit.

PCM TX Source Enables 2 (0x205D)

BIT	7	6	5	4	3	2	1	0
Field	–	–	–	–	–	–	–	PCM_THERM_EN
Reset	–	–	–	–	–	–	–	0x0
Access Type	–	–	–	–	–	–	–	Write, Read

BITFIELD	BITS	DESCRIPTION	DECODE
PCM_THERM_EN	0	Enables transmit of the measured temperature on the assigned data output (DOUT) slot. This output data can be transmitted only in TDM mode.	0: Disable temperature data transmit. 1: Enable temperature data transmit.

PCM Rx Enables (0x205E)

BIT	7	6	5	4	3	2	1	0
Field	–	–	–	–	–	–	PCM_BYP_EN	PCM_RX_EN
Reset	–	–	–	–	–	–		0b0
Access Type	–	–	–	–	–	–	Write, Read	Write, Read

BITFIELD	BITS	DESCRIPTION	DECODE
PCM_BYP_EN	1	Enables the PCM data input to the speaker amplifier via the bypass path. This path bypasses the speaker playback path audio processing features like volume control, gains, DHT, BPE, and thermal foldback.	0x0: Audio processing bypass path disabled. 0x1: Audio processing bypass path enabled.
PCM_RX_EN	0	Enables the speaker amplifier playback path.	0: PCM data input disabled. 1: PCM data input enabled.

PCM Tx Enables (0x205F)

BIT	7	6	5	4	3	2	1	0
Field	–	–	–	–	–	–	–	PCM_TX_EN
Reset	–	–	–	–	–	–	–	0b0
Access Type	–	–	–	–	–	–	–	Write, Read

BITFIELD	BITS	DESCRIPTION	DECODE
PCM_TX_EN	0	Enables the data output (DOUT) of the PCM interface.	0: PCM data output disabled. 1: PCM data output enabled.

PCM Tx Supply Select (0x2060)

BIT	7	6	5	4	3	2	1	0
Field	–	–	–	–	–	–	SUPPLY_SELECT[1:0]	
Reset	–	–	–	–	–	–	0b0	
Access Type	–	–	–	–	–	–	Write, Read	

BITFIELD	BITS	DESCRIPTION	DECODE
SUPPLY_SELECT	1:0	Supply selection for the measurement ADC output to be sent on the DOUT channel.	0: PCM data output disabled. 1: PCM data output enabled.

[ICC Rx Enables A \(0x2070\)](#)

BIT	7	6	5	4	3	2	1	0
Field	ICC_RX_C H7_EN	ICC_RX_C H6_EN	ICC_RX_C H5_EN	ICC_RX_C H4_EN	ICC_RX_C H3_EN	ICC_RX_C H2_EN	ICC_RX_C H1_EN	ICC_RX_C H0_EN
Reset	0b0	0b0	0b0	0b0	0b0	0b0	0b0	0b0
Access Type	Write, Read	Write, Read	Write, Read	Write, Read	Write, Read	Write, Read	Write, Read	Write, Read

BITFIELD	BITS	DESCRIPTION	DECODE
ICC_RX_CH 7_EN	7	Configures whether or not the ICC interface accepts data from this channel.	0: ICC receive channel 7 is disabled. 1: ICC receive channel 7 is enabled.
ICC_RX_CH 6_EN	6	Configures whether or not the ICC interface accepts data from this channel.	0: ICC receive channel 6 is disabled. 1: ICC receive channel 6 is enabled.
ICC_RX_CH 5_EN	5	Configures whether or not the ICC interface accepts data from this channel.	0: ICC receive channel 5 is disabled. 1: ICC receive channel 5 is enabled.
ICC_RX_CH 4_EN	4	Configures whether or not the ICC interface accepts data from this channel.	0: ICC receive channel 4 is disabled. 1: ICC receive channel 4 is enabled.
ICC_RX_CH 3_EN	3	Configures whether or not the ICC interface accepts data from this channel.	0: ICC receive channel 3 is disabled. 1: ICC receive channel 3 is enabled.
ICC_RX_CH 2_EN	2	Configures whether or not the ICC interface accepts data from this channel.	0: ICC receive channel 2 is disabled. 1: ICC receive channel 2 is enabled.
ICC_RX_CH 1_EN	1	Configures whether or not the ICC interface accepts data from this channel.	0: ICC receive channel 1 is disabled. 1: ICC receive channel 1 is enabled.
ICC_RX_CH 0_EN	0	Configures whether or not the ICC interface accepts data from this channel.	0: ICC receive channel 0 is disabled. 1: ICC receive channel 0 is enabled.

[ICC Rx Enables B \(0x2071\)](#)

BIT	7	6	5	4	3	2	1	0
Field	ICC_RX_C H15_EN	ICC_RX_C H14_EN	ICC_RX_C H13_EN	ICC_RX_C H12_EN	ICC_RX_C H11_EN	ICC_RX_C H10_EN	ICC_RX_C H9_EN	ICC_RX_C H8_EN
Reset	0b0	0b0	0b0	0b0	0b0	0b0	0b0	0b0
Access Type	Write, Read	Write, Read	Write, Read	Write, Read	Write, Read	Write, Read	Write, Read	Write, Read

BITFIELD	BITS	DESCRIPTION	DECODE
ICC_RX_CH 15_EN	7	Configures whether or not the ICC interface accepts data from this channel.	0: ICC receive channel 15 is disabled. 1: ICC receive channel 15 is enabled.
ICC_RX_CH 14_EN	6	Configures whether or not the ICC interface accepts data from this channel.	0: ICC receive channel 14 is disabled. 1: ICC receive channel 14 is enabled.
ICC_RX_CH 13_EN	5	Configures whether or not the ICC interface accepts data from this channel.	0: ICC receive channel 13 is disabled. 1: ICC receive channel 13 is enabled.
ICC_RX_CH 12_EN	4	Configures whether or not the ICC interface accepts data from this channel.	0: ICC receive channel 12 is disabled. 1: ICC receive channel 12 is enabled.
ICC_RX_CH 11_EN	3	Configures whether or not the ICC interface accepts data from this channel.	0: ICC receive channel 11 is disabled. 1: ICC receive channel 11 is enabled.
ICC_RX_CH 10_EN	2	Configures whether or not the ICC interface accepts data from this channel.	0: ICC receive channel 10 is disabled. 1: ICC receive channel 10 is enabled.
ICC_RX_CH 9_EN	1	Configures whether or not the ICC interface accepts data from this channel.	0: ICC receive channel 9 is disabled. 1: ICC receive channel 9 is enabled.

BITFIELD	BITS	DESCRIPTION	DECODE
ICC_RX_CH_8_EN	0	Configures whether or not the ICC interface accepts data from this channel.	0: ICC receive channel 8 is disabled. 1: ICC receive channel 8 is enabled.

ICC Tx Control (0x2072)

BIT	7	6	5	4	3	2	1	0
Field	–	ICC_INTERLEAVE_MODE	ICC_DATA_SEL	–	ICC_TX_DEST[3:0]			
Reset	–	0x0	0x0	–	0x0			
Access Type	–	Write, Read	Write, Read	–	Write, Read			

BITFIELD	BITS	DESCRIPTION	DECODE
ICC_INTERLEAVE_MODE	6	Select whether the ICC pin transmits DHT and thermal foldback data in interleaving fashion when the PCM data word size (data width) is only 16-bits. This has no effect when the data word size is 24- or 32-bits.	0: ICC transmits either DHT or thermal data based on ICC_DATA_SEL. 1: ICC transmits in interleaved mode which DHT and thermal data are sent alternatively.
ICC_DATA_SEL	5	Select whether the ICC pin transmits DHT or thermal foldback data when the PCM data word size (data width) is only 16-bits. This has no effect when the data word size is 24- or 32-bits.	0: ICC transmits DHT data + BPE state. 1: ICC transmits thermal foldback data + BPE state.
ICC_TX_DEST	3:0	Selects the device transmit channel for ICC data.	0x0: ICC Channel 0 0x1: ICC Channel 1 ... 0xE: ICC Channel 14 0xF: ICC Channel 15

ICC Enables (0x207F)

BIT	7	6	5	4	3	2	1	0
Field	–	–	–	–	–	ICC_OVER_DOUT_EN	ICC_LINK_EN	ICC_TX_EN
Reset	–	–	–	–	–	0b0	0b0	0x0
Access Type	–	–	–	–	–	Write, Read	Write, Read	Write, Read

BITFIELD	BITS	DESCRIPTION	DECODE
ICC_OVER_DOUT_EN	2	Enables ICC link data sent over the PCM DOUT pin.	0: ICC link over DOUT disabled. 1: ICC link over DOUT enabled.
ICC_LINK_EN	1	Enables ICC link between devices.	0: ICC link disabled. 1: ICC link enabled.
ICC_TX_EN	0	Select whether the ICC pin transmitter is enabled/disabled.	0: ICC transmit disabled. 1: ICC transmit enabled.

[Tone Generator and DC Config \(0x2083\)](#)

BIT	7	6	5	4	3	2	1	0
Field	–	–	TONE_AMPLITUDE[1:0]		TONE_CONFIG[3:0]			
Reset	–	–	0x0		0x4			
Access Type	–	–	Write, Read		Write, Read			

BITFIELD	BITS	DESCRIPTION	DECODE
TONE_AMPLITUDE	5:4	Sets the sine wave amplitude. This register is not used when programming the tone generator to output DC signals.	0x0: -6dBFS 0x1: -4.8dBFS 0x2: 0dBFS 0x3: Reserved
TONE_CONFIG	3:0	Configures the output of the tone generator. For signal outputs, the frequency is a division of the sample rate (f_S).	0x0: DC value programmed by TONE_DC[23:0] 0x1: DC = 0x0000 = 0 0x2: DC = +FullScale/2 0x3: DC = -FullScale/2 0x4: 1kHz tone at all sample rates 0x5: $f_S/4$ 0x6: $f_S/6$ 0x7 to 0xF: Reserved

[Tone Generator DC Level 1 \(0x2084\)](#)

BIT	7	6	5	4	3	2	1	0
Field	TONE_DC[23:16]							
Reset	0x0							
Access Type	Write, Read							

BITFIELD	BITS	DESCRIPTION
TONE_DC	7:0	Sets the tone generator DC output level as a signed binary relative to full-scale.

[Tone Generator DC Level 2 \(0x2085\)](#)

BIT	7	6	5	4	3	2	1	0
Field	TONE_DC[15:8]							
Reset	0x0							
Access Type	Write, Read							

BITFIELD	BITS	DESCRIPTION
TONE_DC	7:0	Sets the tone generator DC output level as a signed binary relative to full-scale.

Tone Generator DC Level 3 (0x2086)

BIT	7	6	5	4	3	2	1	0
Field	TONE_DC[7:0]							
Reset	0x0							
Access Type	Write, Read							

BITFIELD	BITS	DESCRIPTION
TONE_DC	7:0	Sets the tone generator DC output level as a signed binary relative to full-scale.

Tone Generator Enable (0x208F)

BIT	7	6	5	4	3	2	1	0
Field	–	–	–	–	–	–	PINK_NOISE_EN	TONE_EN
Reset	–	–	–	–	–	–	0b0	0b0
Access Type	–	–	–	–	–	–	Write, Read	Write, Read

BITFIELD	BITS	DESCRIPTION	DECODE
PINK_NOISE_EN	1	Enables pink noise data output to the speaker amplifier path.	0: Pink noise disabled. 1: Pink noise enabled.
TONE_EN	0	Enables the tone generator. When enabled, it replaces the PCM interface as the input to the speaker amplifier path.	0: Tone generator disabled. 1: Tone generate enabled.

AMP volume control (0x2090)

BIT	7	6	5	4	3	2	1	0
Field	SPK_VOL[7:0]							
Reset	0x0							
Access Type	Write, Read							

BITFIELD	BITS	DESCRIPTION	DECODE
SPK_VOL	7:0	Sets the digital volume level of the speaker amplifier path.	0x00: 0dB 0x01: -0.5dB 0x02: -1.0dB ...: (-0.5dB steps) 0x7C: -62.0dB 0x7D: -62.5dB 0x7E: -63dB ...: (-0.5dB steps) 0xB4: -90dB 0xB5 - 0xFE: Reserved 0xFF: Mute

[AMP Path Gain \(0x2091\)](#)

BIT	7	6	5	4	3	2	1	0
Field	–	–	–	SPK_GAIN_MAX[4:0]				
Reset	–	–	–	0x12				
Access Type	–	–	–	Write, Read				

BITFIELD	BITS	DESCRIPTION	DECODE
SPK_GAIN_MAX	4:0	Sets the maximum peak output voltage level (V _{MPO}) for the speaker path (no-load). Values in dB are relative to the baseline speaker path DAC full-scale output level of 0.49dBV.	0x00: 2.98V _P (6dB) 0x01: 3.35V _P (7dB) 0x02: 3.76V _P (8dB) 0x03: 4.22V _P (9dB) 0x04: 4.73V _P (10dB) 0x05: 5.31V _P (11dB) 0x06: 5.96V _P (12dB) 0x07: 6.68V _P (13dB) 0x08: 7.50V _P (14dB) 0x09: 8.41V _P (15dB) 0x0A: 9.44V _P (16dB) 0x0B: 10.59V _P (17dB) 0x0C: 11.88V _P (18dB) 0x0D: 13.33V _P (19dB) 0x0E: 14.96V _P (20dB) 0x0F: 16.79V _P (21dB) 0x10: 18.83V _P (22dB) 0x11: 21.13V _P (23dB) 0x12: 23.71V _P (24dB) 0x13: 26.60V _P (25dB) 0x14: 29.85V _P (26dB) 0x15: 33.49V _P (27dB) 0x16-0x1F: Reserved

[AMP DSP Config \(0x2092\)](#)

BIT	7	6	5	4	3	2	1	0
Field	–	SPK_WBAND_FILTER_EN	SPK_SAFE_EN	SPK_VOL_RMPDN_BYPASS	SPK_VOL_RMPUP_BYPASS	SPK_INVERT	SPK_DITH_EN	SPK_DCBLK_EN
Reset	–	0x0	0x1	0b0	0b0	0b0	0b1	0b1
Access Type	–	Write, Read	Write, Read	Write, Read	Write, Read	Write, Read	Write, Read	Write, Read

BITFIELD	BITS	DESCRIPTION	DECODE
SPK_WBAND_FILTER_EN	6	Enables the wideband filters in the speaker amplifier path with increased passband for sample rates higher than 50kHz.	0: Higher passband filters disabled. 1: Higher passband filters enabled.
SPK_SAFE_EN	5	The safe mode bit protects any speaker connected to the device on power-up. When this setting is enabled, the SPK_VOL and SPK_GAIN_MAX settings are ignored, and the amplifier output is set to -18dBFS.	0: Speaker safe mode disabled. 1: Speaker safe mode enabled.
SPK_VOL_RMPDN_BYPASS	4	Controls whether the speaker amplifier path volume is internally ramped down during shutdown and during volume changes.	0: Volume ramp enabled. 1: Volume ramp bypassed.

BITFIELD	BITS	DESCRIPTION	DECODE
SPK_VOL_R MPUP_BY PASS	3	Controls whether the speaker amplifier path volume is internally ramped up during startup and during volume changes.	0: Volume ramp enabled. 1: Volume ramp bypassed.
SPK_INVER T	2	Inverts the speaker amplifier path output.	0: Output is normal. 1: Output is inverted.
SPK_DITH_ EN	1	Selects whether or not dither is applied to data in the speaker amplifier path.	0: Dither disabled. 1: Dither enabled.
SPK_DCBLK _EN	0	Controls the DC blocking filter in the speaker amplifier path.	0: DC blocking filter disabled. 1: DC blocking filter enabled.

SSM Configuration (0x2093)

BIT	7	6	5	4	3	2	1	0
Field	–	–	–	–	TRI_SSM_ EN	–	TRI_SSM_MOD[1:0]	
Reset	–	–	–	–	0x1	–	0x0	
Access Type	–	–	–	–	Write, Read	–	Write, Read	

BITFIELD	BITS	DESCRIPTION	DECODE
TRI_SSM_E N	3	Enables spread-spectrum clocking in the triangle wave generator.	0: Spread-spectrum clocking is disabled. 1: Spread-spectrum clocking is enabled.
TRI_SSM_M OD	1:0	Selects the modulation index for the Class-D amplifier's triangle wave spread-spectrum clock.	0x0: ±1.5% variation 0x1: ±3.0% variation 0x2: ±4.5% variation 0x3: ±6.0% variation

SPK Class DG Threshold (0x2094)

BIT	7	6	5	4	3	2	1	0
Field	–	–	–	SPK_DG_THRES[4:0]				
Reset	–	–	–	0x12				
Access Type	–	–	–	Write, Read				

BITFIELD	BITS	DESCRIPTION	DECODE
SPK_DG_TH RES	4:0	Sets the DG mode fixed peak signal level threshold (active when SPK_DG_SEL = 0x0 or 0x2).	0x00: 3.8V 0x01: 3.7V 0x02: 3.6V 0x03 to 0x1D: ... (0.1V steps) 0x1E: 0.8V 0x1F: 0.7V

SPK Class DG Headroom (0x2095)

BIT	7	6	5	4	3	2	1	0
Field	–	–	SPK_DG_SEL[1:0]		SPK_DG_HEADROOM[3:0]			
Reset	–	–	0x1		0x7			
Access Type	–	–	Write, Read		Write, Read			

BITFIELD	BITS	DESCRIPTION	DECODE
SPK_DG_SEL	5:4	Selects the method used for speaker amplifier DG mode operation.	0x0: Class-DG mode uses a fixed peak signal level threshold (SPK_DG_THRES). 0x1: Class-DG mode uses supply headroom relative to measured VBAT voltage (SPK_DG_HEADROOM). 0x2: Class-DG mode uses the lower of fixed peak signal level threshold (SPK_DG_THRES) and VBAT supply headroom (SPK_DG_HEADROOM). 0x3: Reserved
SPK_DG_HEADROOM	3:0	Sets the DG mode headroom relative to the measured V_{VBAT} supply level (active when SPK_DG_SEL = 0x1 or 0x2).	0x0: 0V 0x1: 0.25V 0x2: 0.5V 0x3 to 0xD: ... (0.25V steps) 0xE: 3.5V 0xF: 3.75V

SPK Class DG Hold Time (0x2096)

BIT	7	6	5	4	3	2	1	0
Field	–	SPK_DG_PEAK_HYST[2:0]			SPK_DG_HOLD_TIME[3:0]			
Reset	–	0x1			0x7			
Access Type	–	Write, Read			Write, Read			

BITFIELD	BITS	DESCRIPTION	DECODE
SPK_DG_PEAK_HYST	6:4	Sets the signal peak hysteresis relative to the measured V_{VBAT} supply level. To switch from D to G, signal peak must be less than VBAT - hysteresis.	0x0: 0.5dB 0x1: 1.0dB 0x2: 1.5dB 0x3: 2.0dB 0x4: 2.5dB 0x5: 3.0dB 0x6: 4.0dB 0x7: 5.0dB
SPK_DG_HOLD_TIME	3:0	Sets the speaker amplifier DG mode hold time. When the peak signal level falls below the DG mode threshold for longer than this time, VBAT is selected as the active amplifier supply.	0x0: 0.15ms 0x1: 0.25ms 0x2: 0.5ms 0x3: 1.0ms 0x4: 2.5ms 0x5: 5.0ms 0x6: 10ms 0x7: 20ms 0x8: 30ms 0x9: 40ms 0xA: 50ms 0xB: 125ms 0xC: 250ms 0xD: 500ms 0xE: 750ms 0xF: 1.0s

[SPK Class DG Delay \(0x2097\)](#)

BIT	7	6	5	4	3	2	1	0
Field	–	–	SPK_DG_DELAY[5:0]					
Reset	–	–	0x0					
Access Type	–	–	Write, Read					

BITFIELD	BITS	DESCRIPTION	DECODE
SPK_DG_DELAY	5:0	Selects the speaker amplifier path signal delay for DG mode operation. Delays the audio output by N samples (N x fs).	0x0: No Delay 0x1: Delay 1 sample 0x2: Delay 2 samples 0x3 to 0x1D: ... (1 sample steps) 0x1E: Delay 30 samples 0x1F: Delay 31 samples 0x20: Delay 32 samples

[SPK Class DG Mode \(0x2098\)](#)

BIT	7	6	5	4	3	2	1	0
Field	–	–	–	–	–	–	SPK_MODE[1:0]	
Reset	–	–	–	–	–	–	0x0	
Access Type	–	–	–	–	–	–	Write, Read	

BITFIELD	BITS	DESCRIPTION	DECODE
SPK_MODE	1:0	Selects the speaker amplifier operating mode.	0x0: DG mode is enabled. 0x1: DG mode is disabled, and the amplifier is always supplied from the PVDD pin. 0x2: DG Mode is disabled, and the amplifier is supplied from the VBAT pin when supply conditions are met. 0x3: Reserved

[SPK Class DG VBAT Level \(0x2099\)](#)

BIT	7	6	5	4	3	2	1	0
Field	–	–	–	–	–	VBATLOW_OK_LVL[2:0]		
Reset	–	–	–	–	–	0x3		
Access Type	–	–	–	–	–	Write, Read		

BITFIELD	BITS	DESCRIPTION	DECODE
VBATLOW_OK_LVL	2:0	Sets the threshold for the VBAT level below which the amplifier is forced to operate in PVDD mode, i.e., the active amplifier supply is PVDD only.	0x0: 2.5V 0x1: 2.6V 0x2: 2.7V 0x3: 2.8V 0x4: 2.9V 0x5: 3.0V 0x6: Reserved 0x7: Reserved

SPK Edge Control (0x209A)

BIT	7	6	5	4	3	2	1	0
Field	–	–	–	–	–	TRI_FSW2 X_MODE	–	–
Reset	–	–	–	–	–	0x0	–	–
Access Type	–	–	–	–	–	Write, Read	–	–

BITFIELD	BITS	DESCRIPTION	DECODE
TRI_FSW2X _MODE	2	Controls the nominal switching frequency of the speaker amplifier.	0: Normal tri-wave oscillation frequency. 1: 2X tri-wave oscillation frequency.

SPK Path Wideband Only Enable (0x209B)

BIT	7	6	5	4	3	2	1	0
Field	–	–	–	–	–	–	–	SPK_WIDE BAND_ONL Y_EN
Reset	–	–	–	–	–	–	–	0b00
Access Type	–	–	–	–	–	–	–	Write, Read

BITFIELD	BITS	DESCRIPTION	DECODE
SPK_WIDEB AND_ONLY_ EN	0	When enabled, only a wideband signal is sent to the amplifier.	0x0: Ultrasound signal mode disabled. 0x1: Ultrasound signal mode enabled.

SPK Edge Control 1 (0x209C)

BIT	7	6	5	4	3	2	1	0
Field	SPK_EN_T URNOFF_S LEW	–	–	–	SPK_SL_RATE_GMODE[3:0]			
Reset	0x0	–	–	–	0x3			
Access Type	Write, Read	–	–	–	Write, Read			

BITFIELD	BITS	DESCRIPTION	DECODE
SPK_EN_TU RNOFF_SLE W	7	Enables turn-off slewing of power FETs.	0: Power FET turn-off slewing disabled. 1: Power FET turn-off slewing enabled.
SPK_SL_RA TE_GMODE	3:0	These bits control the on/off time of the high-side power FET connected to the VBAT supply pin. This in effect, strongly controls the rise time at OUTx nodes in the VBAT mode and weakly controls the fall time at OUTx nodes in VBAT mode, as fall time is strongly controlled by SPK_SL_RATE_LS<3:0>.	

SPK Edge Control 2 (0x209D)

BIT	7	6	5	4	3	2	1	0
Field	SPK_SL_RATE_LS[3:0]				SPK_SL_RATE_HS[3:0]			
Reset	0xF				0xC			
Access Type	Write, Read				Write, Read			

BITFIELD	BITS	DESCRIPTION	DECODE
SPK_SL_RATE_LS	7:4	These bits control the on/off time of the low side power FET. This in effect strongly controls fall time at OUTx node, and weakly controls rise time at OUTx nodes. Rise times are strongly controlled by SPK_SL_RATE_GMODE in VBAT mode, and SPK_SL_RATE_HS in PVDD mode.	0x0000: Slowest rise time. 0x0101: Slower rise time than default. 0x1010: Default rise time. 0x1111: Faster than default rise time.
SPK_SL_RATE_HS	3:0	These bits control the on/off time of high side power FET connected to the PVDD supply pin. This in effect controls strongly rise time at OUTx nodes, and weakly controls fall time of OUTx nodes in PVDD mode. Fall time is strongly controlled by SPK_SL_RATE_LS.	0x0000: Slowest rise time. 0x0101: Slower rise time than default. 0x1010: Default rise time. 0x1111: Faster than default rise time.

Amp Clip Gain (0x209E)

BIT	7	6	5	4	3	2	1	0
Field	–	–	–	–	SPK_GAIN[3:0]			
Reset	–	–	–	–	0x0			
Access Type	–	–	–	–	Write, Read			

BITFIELD	BITS	DESCRIPTION	DECODE
SPK_GAIN	3:0	Sets the digital clip gain level of the speaker amplifier path.	0x00: 0dB 0x01: 0.5dB 0x02: 1.0dB 0x03: 1.5dB 0x04: 2.0dB 0x05: 2.5dB 0x06: 3.0dB 0x07: 3.5dB 0x08: 4.0dB 0x09: 5.0dB 0x0A: 6.0dB 0x0B to 0x0F: Reserved

Bypass Path Config (0x209F)

BIT	7	6	5	4	3	2	1	0
Field	–	–	–	–	–	–	BYP_WBA ND_FILT_E N	BYP_INVE RT
Reset	–	–	–	–	–	–	0x0	0b0
Access Type	–	–	–	–	–	–	Write, Read	Write, Read

BITFIELD	BITS	DESCRIPTION	DECODE
BYP_WBAND_FILT_EN	1	Enables the wideband filters with increased passband for sample rates higher than 50kHz in the amplifier audio processing bypass path.	0x0: Higher passband filters disabled. 0x1: Higher passband filters enabled.
BYP_INVERT	0	Inverts the bypass amplifier path output.	0: Output is normal. 1: Output is inverted.

AMP enables (0x20AF)

BIT	7	6	5	4	3	2	1	0
Field	–	–	–	–	–	–	SPK_FB_EN	SPK_EN
Reset	–	–	–	–	–	–	0b0	0b0
Access Type	–	–	–	–	–	–	Write, Read	Write, Read

BITFIELD	BITS	DESCRIPTION	DECODE
SPK_FB_EN	1	Enables PCM data output from the end of the speaker amplifier path DSP.	0: Speaker amplifier path DSP feedback disabled. 1: Speaker amplifier path DSP feedback enabled.
SPK_EN	0	Enables the speaker amplifier path.	0: Speaker amplifier is disabled. 1: Speaker amplifier is enabled.

Meas ADC Sample Rate (0x20B0)

BIT	7	6	5	4	3	2	1	0
Field	MEAS_ADC_VDDH_SR[1:0]		MEAS_ADC_TEMP_SR[1:0]		MEAS_ADC_PVDD_SR[1:0]		MEAS_ADC_VBAT_SR[1:0]	
Reset	0x0		0x3		0x0		0x0	
Access Type	Write, Read		Write, Read		Write, Read		Write, Read	

BITFIELD	BITS	DESCRIPTION	DECODE
MEAS_ADC_VDDH_SR	7:6	Configures the sample rate of the VDDH channel of the measurement ADC.	00: 300kHz 01: 150kHz 10: 75kHz 11: 37.5kHz
MEAS_ADC_TEMP_SR	5:4	Configures the sample rate of the thermal channel of the measurement ADC.	0x0: 300kHz 0x1: 150kHz 0x2: 75kHz 0x3: 37.5kHz
MEAS_ADC_PVDD_SR	3:2	Configures the sample rate of the PVDD channel of the measurement ADC.	00: 300kHz 01: 150kHz 10: 75kHz 11: 37.5kHz
MEAS_ADC_VBAT_SR	1:0	Configures the sample rate of the VBAT channel of the measurement ADC.	0x0: 300kHz 0x1: 150kHz 0x2: 75kHz 0x3: 37.5kHz

Meas ADC PVDD Config (0x20B1)

BIT	7	6	5	4	3	2	1	0
Field	–	–	–	MEAS_ADC_PVDD_FILTER_EN	MEAS_ADC_PVDD_FILTER_COEFF[3:0]			
Reset	–	–	–	0x0	0x0			
Access Type	–	–	–	Write, Read	Write, Read			

BITFIELD	BITS	DESCRIPTION	DECODE
MEAS_ADC_PVDD_FILTER_EN	4	Controls whether filtering is applied to the PVDD channel output.	0: Filter is bypassed. 1: Filter is applied.
MEAS_ADC_PVDD_FILTER_COEFF	3:0	Sets the PVDD channel lowpass filter bandwidth.	Value: Decode 0x0: 0.4kHz (Across all sample rates) 0x1: 2.5kHz (Across all sample rates) 0x2: 7.5kHz (Across all sample rates) 0x3: 50kHz (Only 150kHz and 300kHz sample rate) 0x4: 150kHz (Only 300kHz sample rate) 0x5 to 0xF: Reserved

Meas ADC VBAT Config (0x20B2)

BIT	7	6	5	4	3	2	1	0
Field	–	–	–	MEAS_ADC_VBAT_FILTER_EN	MEAS_ADC_VBAT_FILTER_COEFF[3:0]			
Reset	–	–	–	0x0	0x00			
Access Type	–	–	–	Write, Read	Write, Read			

BITFIELD	BITS	DESCRIPTION	DECODE
MEAS_ADC_VBAT_FILTER_EN	4	Controls whether filtering is applied to the VBAT channel output.	0: Filter is bypassed. 1: Filter is applied.
MEAS_ADC_VBAT_FILTER_COEFF	3:0	Sets the VBAT channel lowpass filter bandwidth.	Value: Decode 0x0: 0.4kHz (Across all sample rates) 0x1: 2.5kHz (Across all sample rates) 0x2: 7.5kHz (Across all sample rates) 0x3: 50kHz (Only 150kHz & 300kHz sample rate) 0x4: 150kHz (Only 300kHz sample rate) 0x5 to 0xF: Reserved

Meas ADC Thermal Config (0x20B3)

BIT	7	6	5	4	3	2	1	0
Field	–	–	–	MEAS_ADC_TEMP_FILTER_EN	MEAS_ADC_TEMP_FILTER_COEFF[3:0]			
Reset	–	–	–	0x0	0x00			
Access Type	–	–	–	Write, Read	Write, Read			

BITFIELD	BITS	DESCRIPTION	DECODE
MEAS_ADC_TEMP_FILT_EN	4	Controls whether filtering is applied to the thermal channel output.	0: Filter is bypassed. 1: Filter is applied.
MEAS_ADC_TEMP_FILT_COEFF	3:0	Sets the thermal channel lowpass filter bandwidth.	Value: Decode 0x0: 0.4kHz (Across all sample rates) 0x1: 2.5kHz (Across all sample rates) 0x2: 7.5kHz (Across all sample rates) 0x3: 50kHz (Only 150kHz and 300kHz sample rates) 0x4: 150kHz (Only 300kHz sample rate) 0x5 to 0xF: Reserved

Meas ADC VDDH Config (0x20B4)

BIT	7	6	5	4	3	2	1	0
Field	–	–	–	MEAS_ADC_VDDH_FILTER_EN	MEAS_ADC_VDDH_FILTER_COEFF[3:0]			
Reset	–	–	–	0x0	0x00			
Access Type	–	–	–	Write, Read	Write, Read			

BITFIELD	BITS	DESCRIPTION	DECODE
MEAS_ADC_VDDH_FILTER_EN	4	Controls whether filtering is applied to the VDDH channel output.	0: Filter is bypassed. 1: Filter is applied.
MEAS_ADC_VDDH_FILTER_COEFF	3:0	Sets the VDDH channel lowpass filter bandwidth.	Value: Decode 0x0: 0.4kHz (Across all sample rates) 0x1: 2.5kHz (Across all sample rates) 0x2: 7.5kHz (Across all sample rates) 0x3: 50kHz (Only 150kHz and 300kHz sample rates) 0x4: 150kHz (Only 300kHz sample rate) 0x5 to 0xF: Reserved

Meas ADC Readback Control 1 (0x20B5)

BIT	7	6	5	4	3	2	1	0
Field	–	–	–	–	MEAS_ADC_VDDH_RD_MODE	MEAS_ADC_THERM_RD_MODE	MEAS_ADC_VBAT_RD_MODE	MEAS_ADC_PVDD_RD_MODE
Reset	–	–	–	–	0x0	0x0	0x0	0x0
Access Type	–	–	–	–	Write, Read	Write, Read	Write, Read	Write, Read

BITFIELD	BITS	DESCRIPTION	DECODE
MEAS_ADC_VDDH_RD_MODE	3	Controls whether the thermal ADC channel output readback is updated automatically or manually after each conversion is completed.	0: Measurement ADC channel readback data is automatically updated. 1: Initiates a measurement and locks the result into the measurement ADC channel readback register.
MEAS_ADC_THERM_RD_MODE	2	Controls whether the thermal ADC channel output readback is updated automatically or manually after each conversion is completed.	0: Measurement ADC channel readback data is automatically updated. 1: Initiates a measurement and locks the result into the measurement ADC channel readback register.

BITFIELD	BITS	DESCRIPTION	DECODE
MEAS_ADC_VBAT_RD_MODE	1	Controls whether the VBAT ADC channel output readback is updated automatically or manually after each conversion is completed.	0: Measurement ADC channel readback data is automatically updated. 1: Initiates a measurement and locks the result into the measurement ADC channel readback register.
MEAS_ADC_PVDD_RD_MODE	0	Controls whether the PVDD ADC channel output readback is updated automatically or manually after each conversion is completed.	0: Measurement ADC channel readback data is automatically updated. 1: Initiates a measurement and locks the result into the measurement ADC channel readback register.

Meas ADC Readback Control 2 (0x20B6)

BIT	7	6	5	4	3	2	1	0
Field	–	–	–	–	MEAS_ADC_VDDH_RD_UPD	MEAS_ADC_THERM_RD_UPD	MEAS_ADC_VBAT_RD_UPD	MEAS_ADC_PVDD_RD_UPD
Reset	–	–	–	–	0x0	0x0	0x0	0x0
Access Type	–	–	–	–	Write Only	Write Only	Write Only	Write Only

BITFIELD	BITS	DESCRIPTION	DECODE
MEAS_ADC_VDDH_RD_UPD	3	Write 1 to initiate a measurement and lock the result into the measurement ADC VDDH channel readback register.	0: No effect. 1: Initiates a measurement and locks the result into the measurement ADC channel readback register.
MEAS_ADC_THERM_RD_UPD	2	Write 1 to initiate a measurement and lock the result into the measurement ADC thermal channel readback register.	0: No effect. 1: Initiates a measurement and locks the result into the measurement ADC channel readback register.
MEAS_ADC_VBAT_RD_UPD	1	Write 1 to initiate a measurement and lock the result into the measurement ADC VBAT channel readback register.	0: No effect. 1: Initiates a measurement and locks the result into the measurement ADC channel readback register.
MEAS_ADC_PVDD_RD_UPD	0	Write 1 to initiate a measurement and lock the result into the measurement ADC PVDD channel readback register.	0: No effect. 1: Initiates a measurement and locks the result into the measurement ADC channel readback register.

Meas ADC PVDD Readback MSB (0x20B7)

BIT	7	6	5	4	3	2	1	0
Field	MEAS_ADC_PVDD_DATA[8:1]							
Reset	0x0							
Access Type	Read Only							

BITFIELD	BITS	DESCRIPTION
MEAS_ADC_PVDD_DATA	7:0	Provides the measured PVDD value. To convert the 9-bit code into a real voltage, use the following: Measured V _{PVDD} (V) = MEAS_ADC_PVDD_DATA[8:0] x 0.054703125V

Meas ADC PVDD Readback LSB (0x20B8)

BIT	7	6	5	4	3	2	1	0
Field	–	–	–	–	–	–	–	MEAS_ADC_PVDD_DATA[0]
Reset	–	–	–	–	–	–	–	0x0
Access Type	–	–	–	–	–	–	–	Read Only

BITFIELD	BITS	DESCRIPTION
MEAS_ADC_PVDD_DATA	0	Provides the measured PVDD value. To convert the 9-bit code into a real voltage, use the following: Measured V_{PVDD} (V) = MEAS_ADC_PVDD_DATA[8:0] x 0.054703125V

Meas ADC VBAT Readback MSB (0x20B9)

BIT	7	6	5	4	3	2	1	0
Field	MEAS_ADC_VBAT_DATA[8:1]							
Reset	0x0							
Access Type	Read Only							

BITFIELD	BITS	DESCRIPTION
MEAS_ADC_VBAT_DATA	7:0	Provides the measured VBAT value. To convert the 9-bit code into a real voltage, use the following: Measured V_{VBAT} (V) = MEAS_ADC_VBAT_DATA[8:0] x 0.0113965V

Meas ADC VBAT Readback LSB (0x20BA)

BIT	7	6	5	4	3	2	1	0
Field	–	–	–	–	–	–	–	MEAS_ADC_VBAT_DATA[0]
Reset	–	–	–	–	–	–	–	0x0
Access Type	–	–	–	–	–	–	–	Read Only

BITFIELD	BITS	DESCRIPTION
MEAS_ADC_VBAT_DATA	0	Provides the measured VBAT value. To convert the 9-bit code into a real voltage, use the following: Measured V_{VBAT} (V) = MEAS_ADC_VBAT_DATA[8:0] x 0.0113965V

Meas ADC Temp Readback MSB (0x20BB)

BIT	7	6	5	4	3	2	1	0
Field	MEAS_ADC_THERM_DATA[8:1]							
Reset	0x0							
Access Type	Read Only							

BITFIELD	BITS	DESCRIPTION
MEAS_ADC_THERM_DATA	7:0	Provides the measured temperature value. To convert the 9-bit code into a real temperature, use the following: Measured Temperature (°C) = (MEAS_ADC_THERM_DATA[8:0] x 1.0°C) - 252°C

Meas ADC Temp Readback LSB (0x20BC)

BIT	7	6	5	4	3	2	1	0
Field	–	–	–	–	–	–	–	MEAS_ADC_THERM_DATA[0]
Reset	–	–	–	–	–	–	–	0x0
Access Type	–	–	–	–	–	–	–	Read Only

BITFIELD	BITS	DESCRIPTION
MEAS_ADC_THERM_DATA	0	Provides the measured temperature value. To convert the 9-bit code into a real temperature, use the following: Measured Temperature (°C) = (MEAS_ADC_THERM_DATA[8:0] x 1.0°C) - 252°C

Meas ADC VDDH Readback MSB (0x20BD)

BIT	7	6	5	4	3	2	1	0
Field	MEAS_ADC_VDDH_DATA[8:1]							
Reset	0x0							
Access Type	Read Only							

BITFIELD	BITS	DESCRIPTION
MEAS_ADC_VDDH_DATA	7:0	Provides the measured VDDH value. To convert the 9-bit code into a real voltage, use the following: Measured V _{VDDH} (V) = MEAS_ADC_VDDH_DATA[8:0] x 0.054703125V

Meas ADC VDDH Readback LSB (0x20BE)

BIT	7	6	5	4	3	2	1	0
Field	–	–	–	–	–	–	–	MEAS_ADC_VDDH_DATA[0]
Reset	–	–	–	–	–	–	–	0x0
Access Type	–	–	–	–	–	–	–	Read Only

BITFIELD	BITS	DESCRIPTION
MEAS_ADC_VDDH_DATA	0	Provides the measured VDDH value. To convert the 9-bit code into a real voltage, use the following: Measured V _{VDDH} (V) = MEAS_ADC_VDDH_DATA[8:0] x 0.054703125V

[Meas ADC Lowest PVDD Readback MSB \(0x20BF\)](#)

BIT	7	6	5	4	3	2	1	0
Field	LOWEST_PVDD_DATA[8:1]							
Reset	0xFF							
Access Type	Read Only							
BITFIELD	BITS		DESCRIPTION					
LOWEST_PVDD_DATA	7:0		Provides the lowest measured PVDD value. To convert the 9-bit code into a real voltage, use the following: Measured V_{PVDD} (V) = MEAS_ADC_PVDD_DATA[8:0] x 0.054703125V					

[Meas ADC Lowest PVDD Readback LSB \(0x20C0\)](#)

BIT	7	6	5	4	3	2	1	0
Field	–	–	–	–	–	–	–	LOWEST_PVDD_DATA[0]
Reset	–	–	–	–	–	–	–	0x1
Access Type	–	–	–	–	–	–	–	Read, Ext
BITFIELD	BITS		DESCRIPTION					
LOWEST_PVDD_DATA	0		Provides the lowest measured PVDD value. To convert the 9-bit code into a real voltage, use the following: Measured V_{PVDD} (V) = MEAS_ADC_PVDD_DATA[8:0] x 0.054703125V					

[Meas ADC Lowest VBAT Readback MSB \(0x20C1\)](#)

BIT	7	6	5	4	3	2	1	0
Field	LOWEST_VBAT_DATA[8:1]							
Reset	0xFF							
Access Type	Read Only							
BITFIELD	BITS		DESCRIPTION					
LOWEST_VBAT_DATA	7:0		Provides the measured VBAT value. To convert the 9-bit code into a real voltage, use the following: Measured V_{VBAT} (V) = MEAS_ADC_VBAT_DATA[8:0] x 0.0113965V					

[Meas ADC Lowest VBAT Readback LSB \(0x20C2\)](#)

BIT	7	6	5	4	3	2	1	0
Field	–	–	–	–	–	–	–	LOWEST_VBAT_DATA[0]
Reset	–	–	–	–	–	–	–	0x1
Access Type	–	–	–	–	–	–	–	Read, Ext

BITFIELD	BITS	DESCRIPTION
LOWEST_VBAT_DATA	0	Provides the measured VBAT value. To convert the 9-bit code into a real voltage, use the following: Measured V_{VBAT} (V) = MEAS_ADC_VBAT_DATA[8:0] x 0.0113965V

Meas ADC Lowest VDDH Readback MSB (0x20C3)

BIT	7	6	5	4	3	2	1	0
Field	LOWEST_VDDH_DATA[8:1]							
Reset	0xFF							
Access Type	Read Only							

BITFIELD	BITS	DESCRIPTION
LOWEST_VDDH_DATA	7:0	Provides the lowest measured VDDH value. To convert the 9-bit code into a real voltage, use the following: Measured V_{VDDH} (V) = MEAS_ADC_VDDH_DATA[8:0] x 0.054703125V

Meas ADC Lowest VDDH Readback LSB (0x20C4)

BIT	7	6	5	4	3	2	1	0
Field	–	–	–	–	–	–	–	LOWEST_VDDH_DATA[0]
Reset	–	–	–	–	–	–	–	0x1
Access Type	–	–	–	–	–	–	–	Read, Ext

BITFIELD	BITS	DESCRIPTION
LOWEST_VDDH_DATA	0	Provides the lowest measured VDDH value. To convert the 9-bit code into a real voltage, use the following: Measured V_{VDDH} (V) = MEAS_ADC_VDDH_DATA[8:0] x 0.054703125V

Meas ADC Highest Thermal Readback MSB (0x20C5)

BIT	7	6	5	4	3	2	1	0
Field	HIGHEST_THERM_DATA_MSB[7:0]							
Reset	0x00							
Access Type	Read Only							

BITFIELD	BITS	DESCRIPTION
HIGHEST_THERM_DATA_MSB	7:0	Provides the highest measured thermal value. To convert the 9-bit code into a real temperature, use the following: Highest Measured Temperature (°C) = (HIGHEST_THERM_DATA[8:0] x 1.0°C) - 252°C

[Meas ADC Highest Thermal Readback LSB \(0x20C6\)](#)

BIT	7	6	5	4	3	2	1	0
Field	–	–	–	–	–	–	–	HIGHEST_THERM_DATA_LSB
Reset	–	–	–	–	–	–	–	0x0
Access Type	–	–	–	–	–	–	–	Read, Ext

BITFIELD	BITS	DESCRIPTION
HIGHEST_THERM_DATA_LSB	0	Provides the highest measured thermal value. To convert the 9-bit code into a real temperature, use the following: Highest Measured Temperature (°C) = (HIGHEST_THERM_DATA[8:0] x 1.0°C) - 252°C

[Meas ADC Optimal Mode \(0x20C7\)](#)

BIT	7	6	5	4	3	2	1	0
Field	–	–	–	–	MEAS_ADC_OPT_AVE_SEL[1:0]		MEAS_ADC_OPT_MODE[1:0]	
Reset	–	–	–	–	0x1		0x0	
Access Type	–	–	–	–	Write, Read		Write, Read	

BITFIELD	BITS	DESCRIPTION	DECODE
MEAS_ADC_OPT_AVE_SEL	3:2	When MEAS_ADC_OPT_MODE is enabled, the optimized channel's moving average can be set by this register.	0x0: Bypass 0x1: 2 samples 0x2: 4 samples 0x3: Reserved
MEAS_ADC_OPT_MODE	1:0	Enables the measurement ADC optimal mode. When it is set, the BPE power source (depend on BPE_SRC_SEL) runs at the highest rate, the unselected power source runs at a medium rate, and the thermal runs at 37.5kHz fixed. The MEAS_ADC_xxx_SR has no effect in an optimal mode.	0x0: Measurement ADC runs at regular mode. 0x1: Measurement ADC runs at optimal mode 1, BPE power source at 600kHz, second power source at 300kHz, and thermal at 37.5kHz. 0x2: Measurement ADC runs at optimal mode 2, BPE power source at 900kHz, second power source at 75kHz, and thermal at 37.5kHz. 0x3: Reserved

[Meas ADC Config \(0x20C8\)](#)

BIT	7	6	5	4	3	2	1	0
Field	–	–	–	–	–	MEAS_ADC_VDDH_EN	MEAS_ADC_VBAT_EN	MEAS_ADC_PVDD_EN
Reset	–	–	–	–	–	0x0	0x0	0x0
Access Type	–	–	–	–	–	Write, Read	Write, Read	Write, Read

BITFIELD	BITS	DESCRIPTION	DECODE
MEAS_ADC_VDDH_EN	2	Manually enables the measurement ADC VDDH channel.	0: Do not manually enable the measurement ADC channel (may be automatically enabled) 1: Manually force the measurement ADC channel to be enabled anytime the device is in the active state
MEAS_ADC_VBAT_EN	1	Manually enables the measurement ADC VBAT channel.	0: Do not manually enable the measurement ADC channel (may be automatically enabled) 1: Manually force the measurement ADC channel to be enabled anytime the device is in the active state
MEAS_ADC_PVDD_EN	0	Manually enables the measurement ADC PVDD channel.	0: Do not manually enable the measurement ADC channel (may be automatically enabled) 1: Manually force the measurement ADC channel to be enabled anytime the device is in the active state

DHT Configuration 1 (0x20D0)

BIT	7	6	5	4	3	2	1	0
Field	–	–	–	–	DHT_VROT_PNT[3:0]			
Reset	–	–	–	–	0x0			
Access Type	–	–	–	–	Write, Read			

BITFIELD	BITS	DESCRIPTION	DECODE
DHT_VROT_PNT	3:0	Sets the DRC rotation point.	0x0: 0dBFS 0x1: -1dBFS 0x2: -2dBFS 0x3: -3dBFS 0x4: -4dBFS 0x5: -5dBFS 0x6: -6dBFS 0x7: -8dBFS 0x8: -10dBFS 0x9: -12dBFS 0xA: -15dBFS 0xB: Reserved 0xC: Reserved 0xD: Reserved 0xE: Reserved 0xF: Reserved

Limiter Configuration 1 (0x20D1)

BIT	7	6	5	4	3	2	1	0
Field	–	–	–	DHT_HR[4:0]				
Reset	–	–	–	0x8				
Access Type	–	–	–	Write, Read				

BITFIELD	BITS	DESCRIPTION	DECODE
DHT_HR	4:0	Selects the DHT supply headroom for the DRC and limiter functions.	0x0: -20% 0x1: -17.5% 0x2: -15% 0x3: -12.5% 0x4: -10% 0x5: -7.5% 0x6: -5.0% 0x7: -2.5% 0x8: 0% 0x9: +2.5% 0xA: +5.0% 0xB: +7.5% 0xC: +10% 0xD: +12.5% 0xE: +15% 0xF: +17.5% 0x10: +20%

Limiter Configuration 2 (0x20D2)

BIT	7	6	5	4	3	2	1	0
Field	–	–	DHT_LIM_THRESH[4:0]					DHT_LIM_MODE
Reset	–	–	0x0					0x0
Access Type	–	–	Write, Read					Write, Read

BITFIELD	BITS	DESCRIPTION	DECODE
DHT_LIM_THRESHOLD	5:1	Selects the fixed threshold level for signal level limiter mode (SLL). Has no effect in signal distortion limiter mode (SDL).	00000: 0dBFS 00001: -1dBFS 00010: -2dBFS ...: (-1dBFS steps) 01110: -14dBFS 01111: -15dBFS 10000 to 11111: Reserved
DHT_LIM_MODE	0	Selects whether the DHT limiter is in signal distortion or signal level limiter mode.	0: Signal Distortion Limiter mode where limiter threshold tracks supply 1: Signal Level Limiter mode where limiter uses fixed thresholds

DHT Configuration 2 (0x20D3)

BIT	7	6	5	4	3	2	1	0
Field	–	–	–	DHT_MAX_ATN[4:0]				
Reset	–	–	–	0x14				
Access Type	–	–	–	Write, Read				

BITFIELD	BITS	DESCRIPTION	DECODE
DHT_MAX_ATTEN	4:0	Selects the maximum attenuation that can be applied to the audio signal by the DHT.	0x0: Reserved 0x1: -1dB 0x2: -2dB 0x3: -3dB 0x4: -4dB 0x5: -5dB 0x6: -6dB 0x7: -7dB 0x8: -8dB 0x9: -9dB 0xA: -10dB 0xB: -11dB 0xC: -12dB 0xD: -13dB 0xE: -14dB 0xF: -15dB 0x10: -16dB 0x11: -17dB 0x12: -18dB 0x13: -19dB 0x14: -20dB 0x15-0x1F: Reserved

DHT Configuration 3 (0x20D4)

BIT	7	6	5	4	3	2	1	0
Field	-	-	-	-	DHT_ATK_RATE[3:0]			
Reset	-	-	-	-	0x2			
Access Type	-	-	-	-	Write, Read			

BITFIELD	BITS	DESCRIPTION	DECODE
DHT_ATTACK_RATE	3:0	Selects the DHT attack rate.	0x0: 20 μ s/dB 0x1: 40 μ s/dB 0x2: 80 μ s/dB 0x3: 160 μ s/dB 0x4: 320 μ s/dB 0x5: 640 μ s/dB 0x6: 1.28ms/dB 0x7: 2.56ms/dB 0x8: 5.12ms/dB 0x9: 10.24ms/dB 0xA: 20.48ms/dB 0xB: 40.96ms/dB 0xC: 81.92ms/dB 0xD: 163.84ms/dB 0xE: Reserved 0xF: Reserved

[DHT Configuration 4 \(0x20D5\)](#)

BIT	7	6	5	4	3	2	1	0
Field	–	–	–	–	DHT_RLS_RATE[3:0]			
Reset	–	–	–	–	0x4			
Access Type	–	–	–	–	Write, Read			

BITFIELD	BITS	DESCRIPTION	DECODE
DHT_RLS_RATE	3:0	Selects the DHT release rate.	0x0: 1.67ms/dB 0x1: 3.33ms/dB 0x2: 6.67ms/dB 0x3: 13.33ms/dB 0x4: 26.67ms/dB 0x5: 53.33ms/dB 0x6: 106.67ms/dB 0x7: 213.33ms/dB 0x8: 426.67ms/dB 0x9: 853.33ms/dB 0xA: 1706.67ms/dB 0xB: 3413.33ms/dB 0xC: 6826.67ms/dB 0xD: 13653.33ms/dB 0xE: Reserved 0xF: Reserved

[DHT Supply Hysteresis Configuration \(0x20D6\)](#)

BIT	7	6	5	4	3	2	1	0
Field	–	–	–	–	DHT_SUPPLY_HYST[2:0]			DHT_SUPPLY_HYST_EN
Reset	–	–	–	–	0x3			0x1
Access Type	–	–	–	–	Write, Read			Write, Read

BITFIELD	BITS	DESCRIPTION	DECODE
DHT_SUPPLY_HYST	3:1	Selects the supply hysteresis for DHT attenuation release when supply increases.	0x0: 1 LSB 0x1: 2 LSB 0x2: 3 LSB 0x3: 4 LSB 0x4: 6 LSB 0x5: 8 LSB 0x6: 10 LSB 0x7: 12 LSB
DHT_SUPPLY_HYST_EN	0	Select whether PVDD DHT hysteresis is enabled or disabled.	0: DHT is disabled 1: DHT is enabled

DHT Enable (0x20DF)

BIT	7	6	5	4	3	2	1	0
Field	–	–	–	–	–	–	–	DHT_EN
Reset	–	–	–	–	–	–	–	0x0
Access Type	–	–	–	–	–	–	–	Write, Read

BITFIELD	BITS	DESCRIPTION	DECODE
DHT_EN	0	Select whether DHT is enabled or disabled.	0: DHT is disabled. 1: DHT is enabled.

I_V Sense Path Config (0x20E0)

BIT	7	6	5	4	3	2	1	0
Field	–	–	–	–	IVADC_WB AND_FILT_ EN	IVADC_DIT H_EN	IVADC_I_D CBLK_EN	IVADC_V_ DCBLK_EN
Reset	–	–	–	–	0x0	0b1	0b1	0b1
Access Type	–	–	–	–	Write, Read	Write, Read	Write, Read	Write, Read

BITFIELD	BITS	DESCRIPTION	DECODE
IVADC_WBAND_FILT_EN	3	Enables the wideband filters with increased passband for sample rates higher than 50kHz in the IV ADC path.	0x0: Higher passband filters disabled. 0x1: Higher passband filters enabled.
IVADC_DITH_EN	2	Select whether or not dither is applied to the I/V sense ADC path.	0: Dither disabled. 1: Dither enabled.
IVADC_I_DCBLK_EN	1	Enables the DC blocking filter in the current sense ADC path.	0: DC blocker disabled. 1: DC blocker enabled.
IVADC_V_DCBLK_EN	0	Enables the DC blocking filter in the voltage sense ADC path.	0: DC blocker disabled. 1: DC blocker enabled.

I_V Sense Path Enables (0x20E4)

BIT	7	6	5	4	3	2	1	0
Field	–	–	–	–	–	IVADC_IM_ EN	IVADC_I_E N	IVADC_V_E N
Reset	–	–	–	–	–	0b0	0b0	0b0
Access Type	–	–	–	–	–	Write, Read	Write, Read	Write, Read

BITFIELD	BITS	DESCRIPTION	DECODE
IVADC_IM_EN	2	Enables the speaker current and voltage sense ADC path. When this bit is set to 1, the current sense ADC and voltage sense ADC paths are powered up if the device is in the active state (EN = 1) during idle mode.	0: Speaker current sense ADC and voltage sense ADC paths are disabled during idle mode. 1: Speaker current sense ADC and voltage sense ADC paths are enabled during idle mode.
IVADC_I_EN	1	Enables the speaker current sense ADC path. When this bit is set to 1, the current sense ADC path is powered up if the device is in the active state (EN = 1).	0: Speaker current sense ADC path disabled. 1: Speaker current sense ADC path enabled.

BITFIELD	BITS	DESCRIPTION	DECODE
IVADC_V_EN	0	Enables the speaker voltage sense ADC path. When this bit is set to 1, the voltage sense ADC path is powered up if the device is in the active state (EN = 1).	0: Speaker voltage sense ADC path disabled. 1: Speaker voltage sense ADC path enabled.

BPE State (0x20E5)

BIT	7	6	5	4	3	2	1	0
Field	–	–	–	–	–	BPE_STATE[2:0]		
Reset	–	–	–	–	–	0x0		
Access Type	–	–	–	–	–	Read Only		

BITFIELD	BITS	DESCRIPTION	DECODE
BPE_STATE	2:0	Current level of brownout controller. Reads back 000 when EN = 0.	000: Brownout inactive - normal operation 001: Level 3 010: Level 2 011: Level 1 100: Level 0 101 to 111: Reserved

BPE L3 Threshold MSB (0x20E6)

BIT	7	6	5	4	3	2	1	0
Field	BPE_L3_VTHRESH[8:1]							
Reset	0x0							
Access Type	Write, Read							

BITFIELD	BITS	DESCRIPTION
BPE_L3_VTHRESH	7:0	BPE_Ln_VTHRESH[8:0] sets the trigger level for each threshold in the brownout controller. See the Measurement ADC CH0 (PVDD) Result register to set these levels. A value of 0000 0000 (all zeros) means that state is not used and is entirely bypassed.

BPE L3 Threshold LSB (0x20E7)

BIT	7	6	5	4	3	2	1	0
Field	–	–	–	–	–	–	–	BPE_L3_VTHRESH[0]
Reset	–	–	–	–	–	–	–	0x0
Access Type	–	–	–	–	–	–	–	Write, Read

BITFIELD	BITS	DESCRIPTION
BPE_L3_VTHRESH	0	

BPE L2 Threshold MSB (0x20E8)

BIT	7	6	5	4	3	2	1	0
Field	BPE_L2_VTHRESH[8:1]							
Reset	0x0							
Access Type	Write, Read							

BITFIELD	BITS	DESCRIPTION
BPE_L2_VTHRESH	7:0	BPE_Ln_VTHRESH[8:0] Sets the trigger level for each threshold in the brownout controller. See the Measurement ADC CH0 (PVDD) Result register to set these levels. A value of 0000 0000 (all zeros) means that state is not used and is entirely bypassed.

BPE L2 Threshold LSB (0x20E9)

BIT	7	6	5	4	3	2	1	0
Field	–	–	–	–	–	–	–	BPE_L2_VTHRESH[0]
Reset	–	–	–	–	–	–	–	0x0
Access Type	–	–	–	–	–	–	–	Write, Read

BITFIELD	BITS	DESCRIPTION
BPE_L2_VTHRESH	0	

BPE L1 Threshold MSB (0x20EA)

BIT	7	6	5	4	3	2	1	0
Field	BPE_L1_VTHRESH[8:1]							
Reset	0x0							
Access Type	Write, Read							

BITFIELD	BITS	DESCRIPTION
BPE_L1_VTHRESH	7:0	BPE_Ln_VTHRESH[8:0] Sets the trigger level for each threshold in the brownout controller. See the Measurement ADC CH0 (PVDD) Result register to set these levels. A value of 0000 0000 (all zeros) means that state is not used and is entirely bypassed.

BPE L1 Threshold LSB (0x20EB)

BIT	7	6	5	4	3	2	1	0
Field	–	–	–	–	–	–	–	BPE_L1_VTHRESH[0]
Reset	–	–	–	–	–	–	–	0x0
Access Type	–	–	–	–	–	–	–	Write, Read

BITFIELD	BITS	DESCRIPTION
BPE_L1_VTHRESH	0	

BPE L0 Threshold MSB (0x20EC)

BIT	7	6	5	4	3	2	1	0
Field	BPE_L0_VTHRESH[8:1]							
Reset	0x0							
Access Type	Write, Read							

BITFIELD	BITS	DESCRIPTION
BPE_L0_VTHRESH	7:0	BPE_Ln_VTHRESH[7:0] Sets the trigger level for each threshold in the brownout controller. See the Measurement ADC CH0 (PVDD) Result register to set these levels. BA value of 0000 0000 (all zeros) means that state is not used and is entirely bypassed (no hold times). Level 0 cannot be bypassed by writing all zeros.

BPE L0 Threshold LSB (0x20ED)

BIT	7	6	5	4	3	2	1	0
Field	–	–	–	–	–	–	–	BPE_L0_VTHRESH[0]
Reset	–	–	–	–	–	–	–	0x0
Access Type	–	–	–	–	–	–	–	Write, Read

BITFIELD	BITS	DESCRIPTION
BPE_L0_VTHRESH	0	

BPE L3 Dwell and Hold Time (0x20EE)

BIT	7	6	5	4	3	2	1	0
Field	–	–	BPE_L3_DWELL[2:0]			BPE_L3_HOLD[2:0]		
Reset	–	–	0x0			0x0		
Access Type	–	–	Write, Read			Write, Read		

BITFIELD	BITS	DESCRIPTION	DECODE
BPE_L3_DWELL	5:3	Sets the BPE level 3 gain attenuation dwell time.	0x0: 0 μ s 0x1: 100 μ s 0x2: 250 μ s 0x3: 500 μ s 0x4: 1000 μ s 0x5: 2000 μ s 0x6: 4000 μ s 0x7: 8000 μ s

BITFIELD	BITS	DESCRIPTION	DECODE
BPE_L3_HOLD	2:0	Sets the BPE level 3 gain attenuation hold time.	0x0: 0ms 0x1: 10ms 0x2: 100ms 0x3: 250ms 0x4: 500ms 0x5: 1000ms 0x6: 2000ms 0x7: Infinite

BPE L2 Dwell and Hold Time (0x20EF)

BIT	7	6	5	4	3	2	1	0
Field	–	–	BPE_L2_DWELL[2:0]			BPE_L2_HOLD[2:0]		
Reset	–	–	0x0			0x0		
Access Type	–	–	Write, Read			Write, Read		

BITFIELD	BITS	DESCRIPTION	DECODE
BPE_L2_DWELL	5:3	Sets the BPE level 2 gain attenuation dwell time.	0x0: 0μs 0x1: 100μs 0x2: 250μs 0x3: 500μs 0x4: 1000μs 0x5: 2000μs 0x6: 4000μs 0x7: 8000μs
BPE_L2_HOLD	2:0	Sets the BPE level 2 gain attenuation hold time.	0x0: 0ms 0x1: 10ms 0x2: 100ms 0x3: 250ms 0x4: 500ms 0x5: 1000ms 0x6: 2000ms 0x7: Infinite

BPE L1 Dwell and Hold Time (0x20F0)

BIT	7	6	5	4	3	2	1	0
Field	–	–	BPE_L1_DWELL[2:0]			BPE_L1_HOLD[2:0]		
Reset	–	–	0x0			0x0		
Access Type	–	–	Write, Read			Write, Read		

BITFIELD	BITS	DESCRIPTION	DECODE
BPE_L1_DWELL	5:3	Sets the BPE level 1 gain attenuation dwell time.	0x0: 0μs 0x1: 100μs 0x2: 250μs 0x3: 500μs 0x4: 1000μs 0x5: 2000μs 0x6: 4000μs 0x7: 8000μs

BITFIELD	BITS	DESCRIPTION	DECODE
BPE_L1_HOLD LD	2:0	Sets the BPE level 1 gain attenuation hold time.	0x0: 0ms 0x1: 10ms 0x2: 100ms 0x3: 250ms 0x4: 500ms 0x5: 1000ms 0x6: 2000ms 0x7: Infinite

BPE L0 Hold Time (0x20F1)

BIT	7	6	5	4	3	2	1	0
Field	–	–	–	–	–	BPE_L0_HOLD[2:0]		
Reset	–	–	–	–	–	0x0		
Access Type	–	–	–	–	–	Write, Read		

BITFIELD	BITS	DESCRIPTION	DECODE
BPE_L0_HOLD LD	2:0	Sets the BPE level 0 gain attenuation hold time.	0x0: 0ms 0x1: 10ms 0x2: 100ms 0x3: 250ms 0x4: 500ms 0x5: 1000ms 0x6: 2000ms 0x7: Infinite

BPE L3 Attack and Release Step (0x20F2)

BIT	7	6	5	4	3	2	1	0
Field	–	–	–	–	BPE_L3_STEP[3:0]			
Reset	–	–	–	–	0x0			
Access Type	–	–	–	–	Write, Read			

BITFIELD	BITS	DESCRIPTION	DECODE
BPE_L3_STEP EP	3:0	Sets the BPE level 3 gain attenuation step size.	0x0: 0.0625dB 0x1: 0.125dB 0x2: 0.1875dB 0x3: 0.25dB 0x4: 0.375dB 0x5: 0.5dB 0x6: 0.75dB 0x7: 1.0dB 0x8: 1.5dB 0x9: 2.0dB 0xA: 2.5dB 0xB: 3.0dB 0xC: 4.0dB 0xD: 5.0dB 0xE: 5.5dB 0xF: 6.0dB

BPE L2 Attack and Release Step (0x20F3)

BIT	7	6	5	4	3	2	1	0
Field	–	–	–	–	BPE_L2_STEP[3:0]			
Reset	–	–	–	–	0x0			
Access Type	–	–	–	–	Write, Read			

BITFIELD	BITS	DESCRIPTION	DECODE
BPE_L2_STEP	3:0	Sets the BPE level 2 gain attenuation step size.	0x0: 0.0625dB 0x1: 0.125dB 0x2: 0.1875dB 0x3: 0.25dB 0x4: 0.375dB 0x5: 0.5dB 0x6: 0.75dB 0x7: 1.0dB 0x8: 1.5dB 0x9: 2.0dB 0xA: 2.5dB 0xB: 3.0dB 0xC: 4.0dB 0xD: 5.0dB 0xE: 5.5dB 0xF: 6.0dB

BPE L1 Attack and Release Step (0x20F4)

BIT	7	6	5	4	3	2	1	0
Field	–	–	–	–	BPE_L1_STEP[3:0]			
Reset	–	–	–	–	0x0			
Access Type	–	–	–	–	Write, Read			

BITFIELD	BITS	DESCRIPTION	DECODE
BPE_L1_STEP	3:0	Sets the BPE level 1 gain attenuation step size.	0x0: 0.0625dB 0x1: 0.125dB 0x2: 0.1875dB 0x3: 0.25dB 0x4: 0.375dB 0x5: 0.5dB 0x6: 0.75dB 0x7: 1.0dB 0x8: 1.5dB 0x9: 2.0dB 0xA: 2.5dB 0xB: 3.0dB 0xC: 4.0dB 0xD: 5.0dB 0xE: 5.5dB 0xF: 6.0dB

BPE L0 Attack and Release Step (0x20F5)

BIT	7	6	5	4	3	2	1	0
Field	–	–	–	–	BPE_L0_STEP[3:0]			
Reset	–	–	–	–	0x0			
Access Type	–	–	–	–	Write, Read			

BITFIELD	BITS	DESCRIPTION	DECODE
BPE_L0_STEP	3:0	Sets the BPE level 0 gain attenuation step size.	Value: Decode 0x0: 0.0625dB 0x1: 0.125dB 0x2: 0.1875dB 0x3: 0.25dB 0x4: 0.375dB 0x5: 0.5dB 0x6: 0.75dB 0x7: 1.0dB 0x8: 1.5dB 0x9: 2.0dB 0xA: 2.5dB 0xB: 3.0dB 0xC: 4.0dB 0xD: 5.0dB 0xE: 5.5dB 0xF: 6.0dB

BPE L3 Max Gain Attn (0x20F6)

BIT	7	6	5	4	3	2	1	0
Field	–	–	–	BPE_L3_MAXATTN[4:0]				
Reset	–	–	–	0x0				
Access Type	–	–	–	Write, Read				

BITFIELD	BITS	DESCRIPTION	DECODE
BPE_L3_MAXATTN	4:0	Sets the BPE level 3 maximum gain attenuation.	0x0: 0dB 0x1: -1dB 0x2: -2dB 0x3: -3dB 0x4: .. 0x1D: ...(-1dB steps) 0x1E: -30dB 0x1F: -31dB

BPE L2 Max Gain Attn (0x20F7)

BIT	7	6	5	4	3	2	1	0
Field	–	–	–	BPE_L2_MAXATTN[4:0]				
Reset	–	–	–	0x0				
Access Type	–	–	–	Write, Read				

BITFIELD	BITS	DESCRIPTION	DECODE
BPE_L2_MAXATTN	4:0	Sets the BPE level 2 maximum gain attenuation.	0x0: 0dB 0x1: -1dB 0x2: -2dB 0x3: -3dB 0x4.. 0x1D: ...(-1dB steps) 0x1E: -30dB 0x1F: -31dB

BPE L1 Max Gain Attn (0x20F8)

BIT	7	6	5	4	3	2	1	0
Field	–	–	–	BPE_L1_MAXATTN[4:0]				
Reset	–	–	–	0x0				
Access Type	–	–	–	Write, Read				

BITFIELD	BITS	DESCRIPTION	DECODE
BPE_L1_MAXATTN	4:0	Sets the BPE level 1 maximum gain attenuation.	0x0: 0dB 0x1: -1dB 0x2: -2dB 0x3: -3dB 0x4.. 0x1D: ...(-1dB steps) 0x1E: -30dB 0x1F: -31dB

BPE L0 Max Gain Attn (0x20F9)

BIT	7	6	5	4	3	2	1	0
Field	–	–	–	BPE_L0_MAXATTN[4:0]				
Reset	–	–	–	0x0				
Access Type	–	–	–	Write, Read				

BITFIELD	BITS	DESCRIPTION	DECODE
BPE_L0_MAXATTN	4:0	Sets the BPE level 0 maximum gain attenuation.	0x0: 0dB 0x1: -1dB 0x2: -2dB 0x3: -3dB 0x4.. 0x1D: ...(-1dB steps) 0x1E: -30dB 0x1F: -31dB

BPE L3 Gain Attack and Rls Rates (0x20FA)

BIT	7	6	5	4	3	2	1	0
Field	–	–	BPE_L3_GAIN_RLS[2:0]			BPE_L3_GAIN_ATK[2:0]		
Reset	–	–	0x0			0x0		
Access Type	–	–	Write, Read			Write, Read		

BITFIELD	BITS	DESCRIPTION	DECODE
BPE_L3_GAIN_RLS	5:3	Sets the BPE level 3 gain attenuation release rate.	0x0: 5ms/step 0x1: 10ms/step 0x2: 25ms/step 0x3: 50ms/step 0x4: 100ms/step 0x5: 250ms/step 0x6: 500ms/step 0x7: 1000ms/step
BPE_L3_GAIN_ATK	2:0	Sets the BPE level 3 gain attenuation attack rate.	0x0: 2.5 μ s/step 0x1: 5 μ s/step 0x2: 10 μ s/step 0x3: 25 μ s/step 0x4: 50 μ s/step 0x5: 100 μ s/step 0x6: 250 μ s/step 0x7: 500 μ s/step

BPE L2 Gain Attack and Rls Rates (0x20FB)

BIT	7	6	5	4	3	2	1	0
Field	–	–	BPE_L2_GAIN_RLS[2:0]			BPE_L2_GAIN_ATK[2:0]		
Reset	–	–	0x0			0x0		
Access Type	–	–	Write, Read			Write, Read		

BITFIELD	BITS	DESCRIPTION	DECODE
BPE_L2_GAIN_RLS	5:3	Sets the BPE level 2 gain attenuation release rate.	0x0: 5ms/step 0x1: 10ms/step 0x2: 25ms/step 0x3: 50ms/step 0x4: 100ms/step 0x5: 250ms/step 0x6: 500ms/step 0x7: 1000ms/step
BPE_L2_GAIN_ATK	2:0	Sets the BPE level 2 gain attenuation attack rate.	0x0: 2.5 μ s/step 0x1: 5 μ s/step 0x2: 10 μ s/step 0x3: 25 μ s/step 0x4: 50 μ s/step 0x5: 100 μ s/step 0x6: 250 μ s/step 0x7: 500 μ s/step

BPE L1 Gain Attack and Rls Rates (0x20FC)

BIT	7	6	5	4	3	2	1	0
Field	–	–	BPE_L1_GAIN_RLS[2:0]			BPE_L1_GAIN_ATK[2:0]		
Reset	–	–	0x0			0x0		
Access Type	–	–	Write, Read			Write, Read		

BITFIELD	BITS	DESCRIPTION	DECODE
BPE_L1_GAIN_RLS	5:3	Sets the BPE level 1 gain attenuation release rate.	0x0: 5ms/step 0x1: 10ms/step 0x2: 25ms/step 0x3: 50ms/step 0x4: 100ms/step 0x5: 250ms/step 0x6: 500ms/step 0x7: 1000ms/step
BPE_L1_GAIN_ATK	2:0	Sets the BPE level 1 gain attenuation attack rate.	0x0: 2.5 μ s/step 0x1: 5 μ s/step 0x2: 10 μ s/step 0x3: 25 μ s/step 0x4: 50 μ s/step 0x5: 100 μ s/step 0x6: 250 μ s/step 0x7: 500 μ s/step

BPE L0 Gain Attack and Rls Rates (0x20FD)

BIT	7	6	5	4	3	2	1	0
Field	–	–	BPE_L0_GAIN_RLS[2:0]			BPE_L0_GAIN_ATK[2:0]		
Reset	–	–	0x0			0x0		
Access Type	–	–	Write, Read			Write, Read		

BITFIELD	BITS	DESCRIPTION	DECODE
BPE_L0_GAIN_RLS	5:3	Sets the BPE level 0 gain attenuation release rate.	0x0: 5ms/step 0x1: 10ms/step 0x2: 25ms/step 0x3: 50ms/step 0x4: 100ms/step 0x5: 250ms/step 0x6: 500ms/step 0x7: 1000ms/step
BPE_L0_GAIN_ATK	2:0	Sets the BPE level 0 gain attenuation attack rate.	0x0: 2.5 μ s/step 0x1: 5 μ s/step 0x2: 10 μ s/step 0x3: 25 μ s/step 0x4: 50 μ s/step 0x5: 100 μ s/step 0x6: 250 μ s/step 0x7: 500 μ s/step

BPE L3 Limiter Config (0x20FE)

BIT	7	6	5	4	3	2	1	0
Field	–	–	–	–	BPE_L3_LIM[3:0]			
Reset	–	–	–	–	0x0			
Access Type	–	–	–	–	Write, Read			

BITFIELD	BITS	DESCRIPTION	DECODE
BPE_L3_LIM	3:0	Sets the limiter threshold for BPE level 3.	0x0: 0dBFS 0x1: -1dBFS 0x2: -2dBFS 0x3: -3dBFS 0x4: -4dBFS 0x5: -5dBFS 0x6: -6dBFS 0x7: -7dBFS 0x8: -8dBFS 0x9: -9dBFS 0xA: -10dBFS 0xB: -11dBFS 0xC: -12dBFS 0xD: -13dBFS 0xE: -14dBFS 0xF: -15dBFS

BPE L2 Limiter Config (0x20FF)

BIT	7	6	5	4	3	2	1	0
Field	–	–	–	–	BPE_L2_LIM[3:0]			
Reset	–	–	–	–	0x0			
Access Type	–	–	–	–	Write, Read			

BITFIELD	BITS	DESCRIPTION	DECODE
BPE_L2_LIM	3:0	Sets the limiter threshold for BPE level 2.	0x0: 0dBFS 0x1: -1dBFS 0x2: -2dBFS 0x3: -3dBFS 0x4: -4dBFS 0x5: -5dBFS 0x6: -6dBFS 0x7: -7dBFS 0x8: -8dBFS 0x9: -9dBFS 0xA: -10dBFS 0xB: -11dBFS 0xC: -12dBFS 0xD: -13dBFS 0xE: -14dBFS 0xF: -15dBFS

BPE L1 Limiter Config (0x2100)

BIT	7	6	5	4	3	2	1	0
Field	–	–	–	–	BPE_L1_LIM[3:0]			
Reset	–	–	–	–	0x0			
Access Type	–	–	–	–	Write, Read			

BITFIELD	BITS	DESCRIPTION	DECODE
BPE_L1_LIM	3:0	Sets the limiter threshold for BPE level 1.	0x0: 0dBFS 0x1: -1dBFS 0x2: -2dBFS 0x3: -3dBFS 0x4: -4dBFS 0x5: -5dBFS 0x6: -6dBFS 0x7: -7dBFS 0x8: -8dBFS 0x9: -9dBFS 0xA: -10dBFS 0xB: -11dBFS 0xC: -12dBFS 0xD: -13dBFS 0xE: -14dBFS 0xF: -15dBFS

BPE L0 Limiter Config (0x2101)

BIT	7	6	5	4	3	2	1	0
Field	–	–	–	–	BPE_L0_LIM[3:0]			
Reset	–	–	–	–	0x0			
Access Type	–	–	–	–	Write, Read			

BITFIELD	BITS	DESCRIPTION	DECODE
BPE_L0_LIM	3:0	Sets the limiter threshold for BPE level 0.	0x0: 0dBFS 0x1: -1dBFS 0x2: -2dBFS 0x3: -3dBFS 0x4: -4dBFS 0x5: -5dBFS 0x6: -6dBFS 0x7: -7dBFS 0x8: -8dBFS 0x9: -9dBFS 0xA: -10dBFS 0xB: -11dBFS 0xC: -12dBFS 0xD: -13dBFS 0xE: -14dBFS 0xF: -15dBFS

BPE L3 Limiter Attack and Release Rates (0x2102)

BIT	7	6	5	4	3	2	1	0
Field	–	–	BPE_L3_LIM_RLS[2:0]			BPE_L3_LIM_ATK[2:0]		
Reset	–	–	0x0			0x0		
Access Type	–	–	Write, Read			Write, Read		

BITFIELD	BITS	DESCRIPTION	DECODE
BPE_L3_LIM_RLS	5:3	Sets the BPE level 3 limiter release rate.	0x0: 5ms/step 0x1: 10ms/step 0x2: 25ms/step 0x3: 50ms/step 0x4: 100ms/step 0x5: 250ms/step 0x6: 500ms/step 0x7: 1000ms/step
BPE_L3_LIM_ATK	2:0	Sets the BPE level 3 limiter attack rate.	0x0: 2.5 μ s/step 0x1: 5 μ s/step 0x2: 10 μ s/step 0x3: 25 μ s/step 0x4: 50 μ s/step 0x5: 100 μ s/step 0x6: 250 μ s/step 0x7: 500 μ s/step

[BPE L2 Limiter Attack and Release Rates \(0x2103\)](#)

BIT	7	6	5	4	3	2	1	0
Field	–	–	BPE_L2_LIM_RLS[2:0]			BPE_L2_LIM_ATK[2:0]		
Reset	–	–	0x0			0x0		
Access Type	–	–	Write, Read			Write, Read		

BITFIELD	BITS	DESCRIPTION	DECODE
BPE_L2_LIM_RLS	5:3	Sets the BPE level 2 limiter release rate.	0x0: 5ms/step 0x1: 10ms/step 0x2: 25ms/step 0x3: 50ms/step 0x4: 100ms/step 0x5: 250ms/step 0x6: 500ms/step 0x7: 1000ms/step
BPE_L2_LIM_ATK	2:0	Sets the BPE level 2 limiter attack rate.	0x0: 2.5 μ s/step 0x1: 5 μ s/step 0x2: 10 μ s/step 0x3: 25 μ s/step 0x4: 50 μ s/step 0x5: 100 μ s/step 0x6: 250 μ s/step 0x7: 500 μ s/step

[BPE L1 Limiter Attack and Release Rates \(0x2104\)](#)

BIT	7	6	5	4	3	2	1	0
Field	–	–	BPE_L1_LIM_RLS[2:0]			BPE_L1_LIM_ATK[2:0]		
Reset	–	–	0x0			0x0		
Access Type	–	–	Write, Read			Write, Read		

BITFIELD	BITS	DESCRIPTION	DECODE
BPE_L1_LIM_RLS	5:3	Sets the BPE level 1 limiter release rate.	0x0: 5ms/step 0x1: 10ms/step 0x2: 25ms/step 0x3: 50ms/step 0x4: 100ms/step 0x5: 250ms/step 0x6: 500ms/step 0x7: 1000ms/step
BPE_L1_LIM_ATK	2:0	Sets the BPE level 1 limiter attack rate.	0x0: 2.5 μ s/step 0x1: 5 μ s/step 0x2: 10 μ s/step 0x3: 25 μ s/step 0x4: 50 μ s/step 0x5: 100 μ s/step 0x6: 250 μ s/step 0x7: 500 μ s/step

[BPE L0 Limiter Attack and Release Rates \(0x2105\)](#)

BIT	7	6	5	4	3	2	1	0
Field	–	–	BPE_L0_LIM_RLS[2:0]			BPE_L0_LIM_ATK[2:0]		
Reset	–	–	0x0			0x0		
Access Type	–	–	Write, Read			Write, Read		

BITFIELD	BITS	DESCRIPTION	DECODE
BPE_L0_LIM_RLS	5:3	Sets the BPE level 0 limiter release rate.	0x0: 5ms/step 0x1: 10ms/step 0x2: 25ms/step 0x3: 50ms/step 0x4: 100ms/step 0x5: 250ms/step 0x6: 500ms/step 0x7: 1000ms/step
BPE_L0_LIM_ATK	2:0	Sets the BPE level 0 limiter attack rate.	0x0: 2.5 μ s/step 0x1: 5 μ s/step 0x2: 10 μ s/step 0x3: 25 μ s/step 0x4: 50 μ s/step 0x5: 100 μ s/step 0x6: 250 μ s/step 0x7: 500 μ s/step

[BPE Threshold Hysteresis \(0x2106\)](#)

BIT	7	6	5	4	3	2	1	0
Field	BPE_VTHRESH_HYST[7:0]							
Reset	0x0							
Access Type	Write, Read							

BITFIELD	BITS	DESCRIPTION	DECODE
BPE_VTHRESH_HYST	7:0	Sets the hysteresis to move up to the next level in the brownout controller. See the measurement ADC PVDD or VBAT channel result register to set these levels.	00000000: No hysteresis 00000001: 1 LSB of hysteresis 00000010: 2 LSBs of hysteresis ...: 1 LSB steps 11111101: 253 LSBs of hysteresis 11111110: 254 LSBs of hysteresis 11111111: 255 LSBs of hysteresis

BPE Infinite Hold Clear (0x2107)

BIT	7	6	5	4	3	2	1	0
Field	–	–	–	–	–	–	–	BPE_HLD_RLS
Reset	–	–	–	–	–	–	–	
Access Type	–	–	–	–	–	–	–	Write Only

BITFIELD	BITS	DESCRIPTION	DECODE
BPE_HLD_RLS	0	Manually releases the BPE controller when infinite hold is enabled.	0x0: Writing 0 has no effect. 0x1: Releases brownout-protection engine controller from infinite hold.

BPE Supply Source (0x2108)

BIT	7	6	5	4	3	2	1	0
Field	–	–	–	–	–	–	BPE_SRC_SEL[1:0]	
Reset	–	–	–	–	–	–	0x0	
Access Type	–	–	–	–	–	–	Write, Read	

BITFIELD	BITS	DESCRIPTION	DECODE
BPE_SRC_SEL	1:0	This bit selects the measurement ADC channel that is the input to the brownout-protection engine controller.	0x0: Measurement ADC PVDD channel is the input to the BPE controller. 0x1: Measurement ADC VBAT channel is the input to the BPE controller. 0x2: Measurement ADC VDDH channel is the input to the BPE controller.

BPE Lowest State (0x2109)

BIT	7	6	5	4	3	2	1	0
Field	–	–	–	–	–	BPE_LOWEST[2:0]		
Reset	–	–	–	–	–	0x0		
Access Type	–	–	–	–	–	Read, Ext		

BITFIELD	BITS	DESCRIPTION	DECODE
BPE_LOWEST	2:0	Returns the lowest level the brownout-protection engine has transitioned to. Upon reading the register it is updated to show the current level of the brownout controller.	000: Brownout inactive - normal operation 001: Level 3 010: Level 2 011: Level 1 100: Level 0 101 to 111: Reserved

BPE Lowest Gain (0x210A)

BIT	7	6	5	4	3	2	1	0
Field	BPE_LOWEST_GAIN[7:0]							
Reset	0x0							
Access Type	Read, Ext							

BITFIELD	BITS	DESCRIPTION	DECODE
BPE_LOWEST_GAIN	7:0	Returns the lowest gain (highest gain attenuation) of the brownout-protection engine. Upon reading the register, it is updated to show the current gain attenuation applied by the BPE. Gain format: 5-bit integer and 3-bit fraction. The integer part is 1dB per step, while the fractional part is 1/8dB per step.	000: Brownout inactive - normal operation 001: Level 3 010: Level 2 011: Level 1 100: Level 0 101 to 111: Reserved

BPE Lowest Limiter (0x210B)

BIT	7	6	5	4	3	2	1	0
Field	BPE_LOWEST_LIMIT[7:0]							
Reset	0x0							
Access Type	Read, Ext							

BITFIELD	BITS	DESCRIPTION	DECODE
BPE_LOWEST_LIMIT	7:0	Return the lowest limiter setting applied by the brownout-protection engine. Upon reading the register, it is updated to show the current limiter setting of the BPE. Limiter format: 4-bit integer and 4-bit fraction. The integer part is 1dB per step, while the fractional part is 1/16dB per step.	000: Brownout inactive - normal operation 001: Level 3 010: Level 2 011: Level 1 100: Level 0 101 to 111: Reserved

BPE Enable (0x210D)

BIT	7	6	5	4	3	2	1	0
Field	–	–	–	–	–	–	BPE_LIM_EN	BPE_EN
Reset	–	–	–	–	–	–	0x0	0x0
Access Type	–	–	–	–	–	–	Write, Read	Write, Read

BITFIELD	BITS	DESCRIPTION	DECODE
BPE_LIM_EN	1	Enables BPE limiter function.	0x0: BPE limiter disabled. 0x1: BPE limiter enabled.
BPE_EN	0	Enables the BPE function.	0x0: BPE Disabled. 0x1: BPE Enabled.

[Auto-Restart Behavior \(0x210E\)](#)

BIT	7	6	5	4	3	2	1	0
Field	–	–	–	–	OVC_AUTO RESTART_ EN	THERM_AU TORESTAR T_EN	VBAT_AUT ORESTART _EN	PVDD_AUT ORESTART _EN
Reset	–	–	–	–	0b0	0b0	0b0	0b0
Access Type	–	–	–	–	Write, Read	Write, Read	Write, Read	Write, Read

BITFIELD	BITS	DESCRIPTION	DECODE
OVC_AUTO RESTART_ EN	3	Controls whether or not the speaker amplifier is automatically reenabled after an overcurrent fault condition.	0: Overcurrent recovery is in manual mode. 1: Overcurrent recovery is in auto mode.
THERM_AU TORESTART _EN	2	Controls whether or not the device automatically returns to the active state when the die temperature recovers from thermal shutdown.	0: Thermal shutdown recovery is in manual mode. 1: Thermal shutdown recovery is in auto mode.
VBAT_AUTO RESTART_ EN	1	Controls whether or not the device automatically returns to the active state when VBAT recovers from UVLO event.	0: VBAT UVLO recovery is in manual mode. 1: VBAT UVLO recovery is in auto mode.
PVDD_AUT ORESTART_ EN	0	Controls whether or not the device automatically returns to the active state when PVDD recovers from UVLO event.	0: PVDD UVLO recovery is in manual mode. 1: PVDD UVLO recovery is in auto mode.

[Global Enable \(0x210F\)](#)

BIT	7	6	5	4	3	2	1	0
Field	–	–	–	–	–	–	–	EN
Reset	–	–	–	–	–	–	–	0x0
Access Type	–	–	–	–	–	–	–	Write, Read, Ext

BITFIELD	BITS	DESCRIPTION	DECODE
EN	0	Disable or enable all blocks and reset all logic except the I ² C interface and control registers.	0: Device powered down. 1: Device enabled.

[Revision ID \(0x22FF\)](#)

BIT	7	6	5	4	3	2	1	0
Field	REV_ID[7:0]							
Reset	0x43							
Access Type	Read Only							

BITFIELD	BITS	DESCRIPTION	DECODE
REV_ID	7:0	Revision of the device. Updated at every device revision.	0x43: Device Revision

Applications Information

Layout and Grounding

Proper layout and grounding are essential for optimum performance. Use at least four PCB layers and add thermal vias to the ground/power plane close to the device to ensure good thermal performance and high-end output power. Good grounding improves audio performance and prevents switching noise from coupling into the audio signal. Ground the power signals and the analog signals of the IC separately at the system ground plane, to prevent switching interference from corrupting sensitive analog signals. Place the recommended supply decoupling capacitors as close as possible to the IC. The PVDD to PGND connection must be kept short and should have minimum trace length and loop area to ensure optimal Noise, THD+N, and EMI performance. Use wide, low-resistance output, supply and ground traces. As load impedance decreases, the current drawn from the device outputs increase. At higher current, the resistance of the output traces decreases the power delivered to the load. For example, if 2W is delivered from the speaker output to a 4Ω load through a 100mΩ trace, 49mW is consumed in the trace. If power is delivered through a 10mΩ trace, only 5mW is consumed in the trace. Wide output, supply, and ground traces also improve the power dissipation of the device. The device is inherently designed for excellent RF immunity. For best performance, add ground fills around all signal traces on the top and bottom PCB planes. It is advisable to follow the layout of the MAX98397 EV kit as closely as possible in the application. Thermal and performance measurements shown in the MAX98397 EV kit data sheet were measured with a 6-layer board ($\theta_{JA} = 28^\circ\text{C/W}$). As a result, the EV kit performance is likely better than what can be achieved with a JEDEC standard board.

Recommended External Components

[Table 13](#) shows the recommended external components. See the [Typical Application Circuit](#) for more details.

Table 13. Component List

BUMP	VALUE	SIZE	VOLTAGE RATING (V)	DIELECTRIC
PVDD	220μF ± 20%	—	50	Alum-Elec
PVDD	10μF ± 10%	1206	50	X5R
PVDD	1μF ± 10%	0603	50	X5R
PVDD	0.1μF ± 10%	0402	50	X7R
VBAT	1μF	0402	16	X5R
VBAT	10μF	0603	25	X5R
DVDD	1μF ± 20%	0201	6.3	X5R
AVDD	1μF ± 20%	0201	6.3	X5R
VBOOTP	0.1μF ± 10%	0402	16	X7R
VBOOTN	0.1μF ± 10%	0402	16	X7R

Bootstrap Capacitors

The output stage of the MAX98397 uses nMOS power FETs as high-side drivers to provide high output power with high efficiency in a small package. A bootstrap capacitor connected between the OUTx pin and VBOOTx pin acts as a floating power supply for the gate driver of the high-side nMOS power FET of the corresponding OUTx pin. During normal operation, the bootstrap capacitor gets charged when the PWM output forces the OUTx pin low i.e., the low-side nMOS power FET of the corresponding OUTx pin is on. As the high-side power FET of the OUTx pin turns on, OUTx and the corresponding VBOOTx pin voltages rise due to capacitive action, thus providing the required high-side driver voltage. The necessary charge to turn on the high-side power FET comes from the bootstrap capacitor, and hence every time the high-side power FET turns on, it loses charge which needs to be replenished during the next low-side turn-on. Thus, it is important to choose a bootstrap capacitor value that can sustain this switching action i.e., large enough to not lose too much charge during high-side turn-on, and any other supervisory circuit biased from the bootstrap capacitor supply.

However, there is an upper limit to how large the bootstrap capacitor can be, apart from being too large on the PCB. During hard-clipping at the output of the Class-D amplifier, the high-side power FET of the OUTx pin can remain on for

MAX98397

28V Digital Input, Class-DG Amplifier with I_{VSENSE} , Ultra-Low I_Q , and Brownout Prevention

hundreds of microseconds. This causes the bootstrap capacitor to continue to lose charge due to charge consumption by internal circuitry and capacitance leakage. When the bootstrap capacitor voltage becomes too low, it forces a small cycle of low-side turn-on to replenish the charge on the bootstrap capacitor. This is called a refresh cycle and care must be taken to ensure that a large capacitor value does not force a refresh cycle at a rate that affects the audio band.

It is recommended to use a 0.1µF, 16V capacitor as a bootstrap capacitor with the MAX98397 and to place the capacitor as close to the pins as possible to minimize the loop between the OUTx and VBOOTx pins.

Typical Application Circuits

Typical Application Circuit

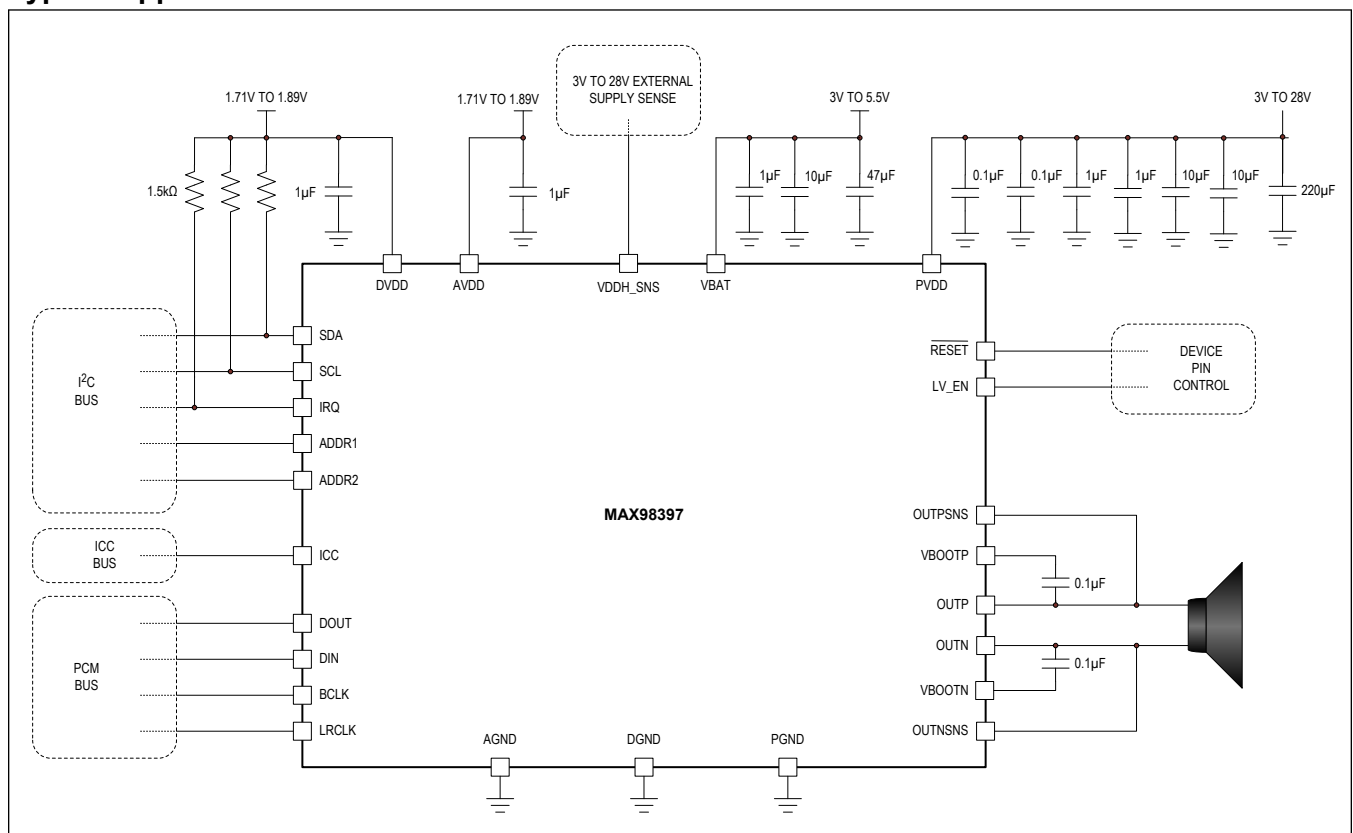

Ordering Information

PART NUMBER	TEMP RANGE	PIN-PACKAGE
MAX98397EWB+	-40°C to +85°C	35 WLP
MAX98397EWB+T	-40°C to +85°C	35 WLP

+Denotes a lead(Pb)-free/RoHS-compliant package.

T = Tape and reel.

MAX98397

28V Digital Input, Class-DG Amplifier with
 I_{VSENSE} , Ultra-Low I_Q , and Brownout Prevention

Revision History

REVISION NUMBER	REVISION DATE	DESCRIPTION	PAGES CHANGED
0	10/23	Release for Market Intro	—