

FEATURES

- Miniature connector with flat plug pins
- Miniature connector size
- Easy jab-in connection for rapid termination. Just push-in wire & tighten screw
- IEC colour code
- The International Electrotechnical Commission (IEC) is an international standards organisation that prepares and publishes international standards.

RS PRO Miniature Quick Wire Connector Thermocouple Plug & Socket

IM-J-MQ+FQ Type J IEC

RS Stock No.: 220-9511



RS Professionally Approved Products bring to you professional quality parts across all product categories. Our product range has been tested by engineers and provides a comparable quality to the leading brands without paying a premium price.

Product Description

Miniature connector with flat plug pins. Easy jab-in connection for rapid termination. Just push-in wire & tighten screw.

General Specifications

General Description	Easy jab-in connection for rapid termination
----------------------------	--

Specifications

Thermocouple Type	J IEC
Connector Size	Miniature
Connector Type	Quick Wire Plug & Socket
Colour	Black
Max. Temperature	220°C
Pins	Flat Pins
+Positive Contact	Iron
-Negative Contact	Copper Nickel

Approvals

RoHS Compliant	Yes
Standards Met	BS EN 50212:1997. RoHS

Thermocouple Connectors Product Guide

A comprehensive family of miniature and standard Thermocouple Connectors, accessories, panels, terminal and barrier blocks. Available in IEC, ANSI & JIS colour specifications.

[Click below to view:](#)

[RS Pro Thermocouple Connector Selection Guide](#)

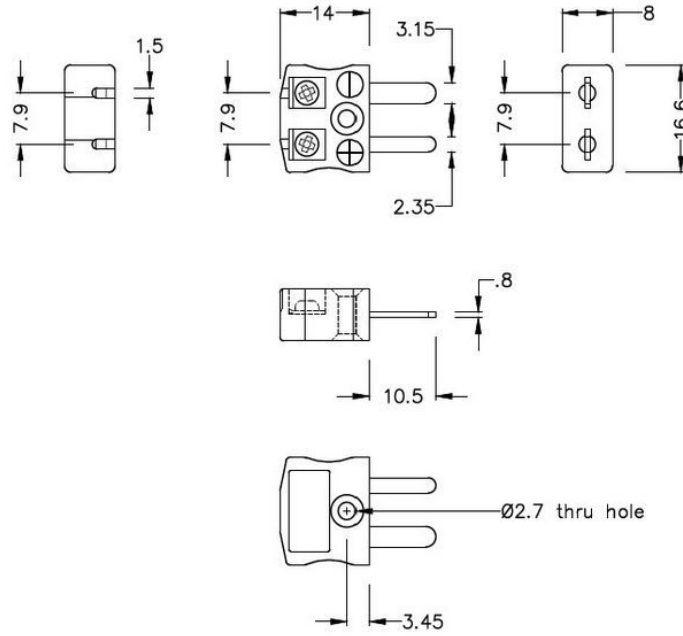



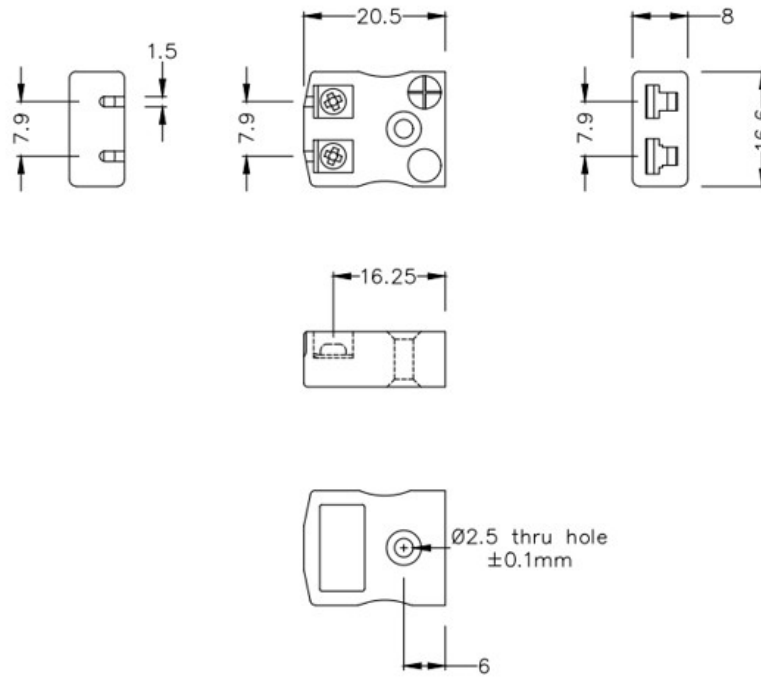















Miniature in-line Plug - Quick Wire
(dimensions in mm)



Miniature in-line Socket - Quick Wire
(dimensions in mm)

RS Components is a leading provider for Automation and Control Gear, below is a selection of best selling products:

<p style="text-align: center;">rspro.com</p>  <p style="text-align: center;">Temperature. It matters</p>	<p style="text-align: center;">Calibration</p> <p>Whether it's existing equipment or a new purchase, you need to have confidence in the accuracy of your measurements.</p> <p>That's where our calibration service can help.</p> <p>Purchase new products with confidence.</p> <p>A certificated calibrated sensor straight out of the box, ready to use.</p>  <p style="text-align: center;">RTD Detectors</p> <p>Wire-wound type provides greater accuracy and stability but are vulnerable to shock.</p> <p>Flat film type are resistant to shock and have quicker thermal response times.</p> <p>Various lengths and diameters available, in class A, B and 1/10th Din.</p>	<p style="text-align: center;">Best Sellers </p>  <p>ANSI SYSCAL Type K Mineral Insulated Thermocouple RS 181-7296</p>  <p>IEC SYSCAL Type K Mineral Insulated Thermocouple RS 181-7288</p>  <p>IEC SYSCAL Type J Mineral Insulated Thermocouple RS 181-7305</p>
 <p style="text-align: center;">Exposed Junction Thermocouples</p> <p>Including exposed junctions with fitted or moulded miniature plug and insulated leads, ideal for test and development applications.</p> <p>1, 2, 3, 5 & 10m lengths available in IEC or ANSI colours.</p>	<p style="text-align: center;">Best Sellers </p>  <p>ANSI Type K Exposed Junction RS 814-0134 Allied 70656459</p>  <p>ANSI Type K High Temp Exposed Junction RS 131-4749 Allied 71080908</p>  <p>IEC Type K Exposed Junction RS 363-0250 Allied 70643600</p>	<p style="text-align: center;">Best Sellers </p>  <p>Magnet Thermocouple RS 762-1115 Allied 70651739</p>  <p>Heavy Duty Thermocouple RS 762-1128 Allied 70651743</p>  <p>Rubber Patch Thermocouple RS 290-5036 Allied 70642886</p>
 <p style="text-align: center;">Thermocouple & PRT Cable</p> <p>Thermocouple cables are available in IEC or ANSI colour codes. Insulation types include PFA, PTFE, PVC & Fibreglass. Available spool lengths include 10, 25, 50, 100 and 200m.</p>	<p style="text-align: center;">Best Sellers </p>  <p>IEC PVC Insulated Flat Pair RS 219-4573 Allied 70641630</p>  <p>ANSI PFA Insulated Twin Twisted RS 814-0030 Allied 70656106</p>  <p>IEC Glassfibre Insulated Flat Pair RS 236-3836 Allied 70641730</p>	<p style="text-align: center;">Best Sellers </p>  <p>IEC Thermocouple Plug RS 455-9764 Allied 70644391</p>  <p>ANSI Thermocouple Socket RS 769-1127 Allied 70652125</p>  <p>IEC Thermocouple PCB Socket RS 381-7570 Allied 70643749</p>

RS Components is a leading provider for Automation and Control Gear, below is a selection of best selling products:

 <p>Mineral Insulated Thermocouples</p> <p>Available in various calibration types with a variety of terminations. These include; Thermocouple plugs, Terminal heads and Thermocouple cable</p>	<p>Best Sellers </p> <p>IEC Thermocouple with PTFE Cable RS 397-1236 Allied 70643843</p> <p>IEC Thermocouple with Mini Plug RS 397-1488 Allied 70643863</p> <p>ANSI Thermocouple with PFA Cable RS 847-1019 Allied 70658112</p>	 <p>NEW PRODUCTS</p> <p>RS PRO, the own brand of RS Components, offers an unbeatable range of products across all industries with quality you can trust.</p> <p>New products are constantly added to improve the offering of our product range.</p>	<p>NEW PRODUCTS </p> <p>Brake Pad Temp Sensor RS 200-0601 Allied 72173869</p> <p>RTD Temp Sensor Hirschmann Style RS 200-0594 Allied 72173862</p> <p>Washer Thermocouple RS 200-0616 Allied 72173882</p>
 <p>Sensors with Industrial Terminal Heads</p> <p>Industrial sensors housed in a stainless steel sheath and terminal head protection to IP67. Available as a thermocouple or Pt100.</p>	<p>Best Sellers </p> <p>Type K 300mm Long RS 787-7829 Allied 70653306</p> <p>Type K 200mm Long RS 787-7816 Allied 70653303</p> <p>Type K 100mm Long RS 787-7804 Allied 70653235</p>	<p>www.rspro.com</p>  <p>www.alliedelec.com</p>	
 <p>L60 Fine Wire Thermocouple Welder</p> <p>The Thermocouple Welder is a compact, simple-to-use instrument designed for thermocouple and fine wire welding. Supplied with foot switch, spare electrodes, pliers & safety glasses, impact clip and pen plate.</p>	<p>Best Sellers </p> <p>L60 Fine Wire Thermocouple Welder RS 363-0351 Allied 70825788</p> 		