

Datasheet

Worm Drive Zinc Plated Mild Steel Hose Clip

RS Stock No: 145-0254



Specification:

Material: Mild Steel

Plating: Zinc Plated

RoHS Complaint

Drawing:

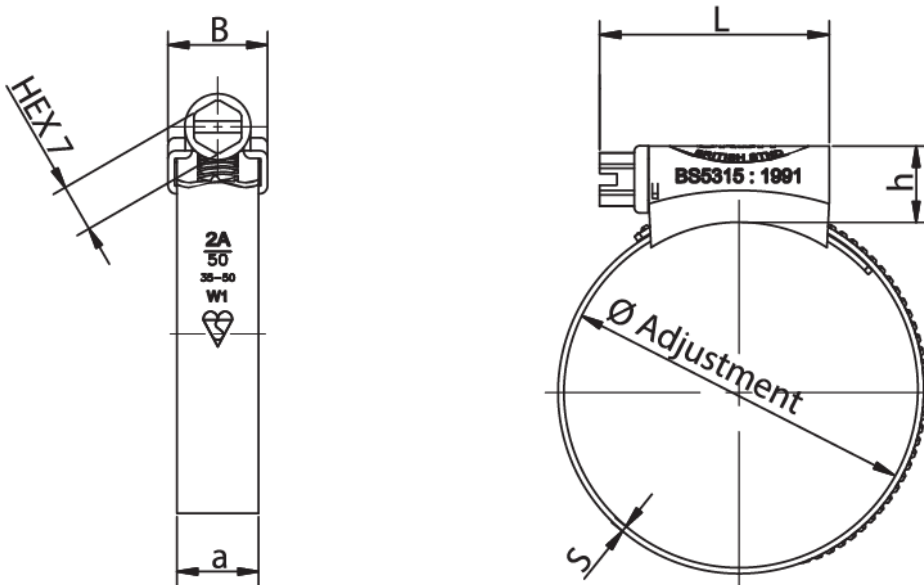

Stock no	BS Size	Inside Diameter		L max	S±0.05	h max	a Band Width	b max	Torque Nm	
		mm	in							
1450243	12	9.5 – 12	3/8 - 1/2	19.5	0.95	10.0	9.5	12.3	4.5	
1450244	16	11 – 16	1/2 - 5/8							
1450245	20	13 – 20	1/2 - 3/4							
1450246	22	16 – 22	5/8 - 7/8	25.0		11.5	12.0	14.7	5.6	
1450247	25	18 – 25	3/4 - 1							
1450248	30	22 – 30	7/8 - 1 1/8							
1450249	35	25 – 35	1 - 1 3/8							
1450250	40	30 – 40	1 1/8 - 1 5/8							
1450251	45	35 – 45	1 3/8 - 1 3/4							
1450252	50	35 – 50	1 3/8 - 2	33.0			11.5	12.0	14.7	7.9
1450253	55	40 – 55	1 5/8 - 2 1/8							
1450254	60	45 – 60	1 3/4 - 2 3/8							
1450255	70	55 – 70	2 - 2 3/4							
1450256	80	60 – 80	2 3/8 - 3 1/8							
1450257	90	70 – 90	2 3/4 - 3 1/2							
1450258	100	85 – 100	3 1/8 - 4	33.0	11.5	12.0		14.7	9.0	
1450259	120	90 – 120	3 1/2 - 4 3/4							
1450260	140	120 – 140	4 1/8 - 5							
1450261	160	130 – 160	5 1/8 - 6 1/4							
1450262	180	150 – 180	5 7/8 - 7 1/8							
1450263	200	170 – 200	6 5/8 - 7 7/8							



Product feature:

These hose clips are made from the finest cold rolled steel with a special surface treatment. They are manufactured and “BSI Kitemark™” certified according to British Standard 5315:1991.

The band is processed to erase any burrs from the edges and to increase strength ensuring a high destructive torque. The band thread is cold formed and results in smooth underside surface to optimize hose protection. It protects soft hoses from damage during installation, providing exterior hose wall protection. The housing is riveted for extra strength and provides smooth contact with the hose.