

Datasheet

Telephone Slide LED Indicator Lamp

RS Stock number 205-117

Dimensions (mm):

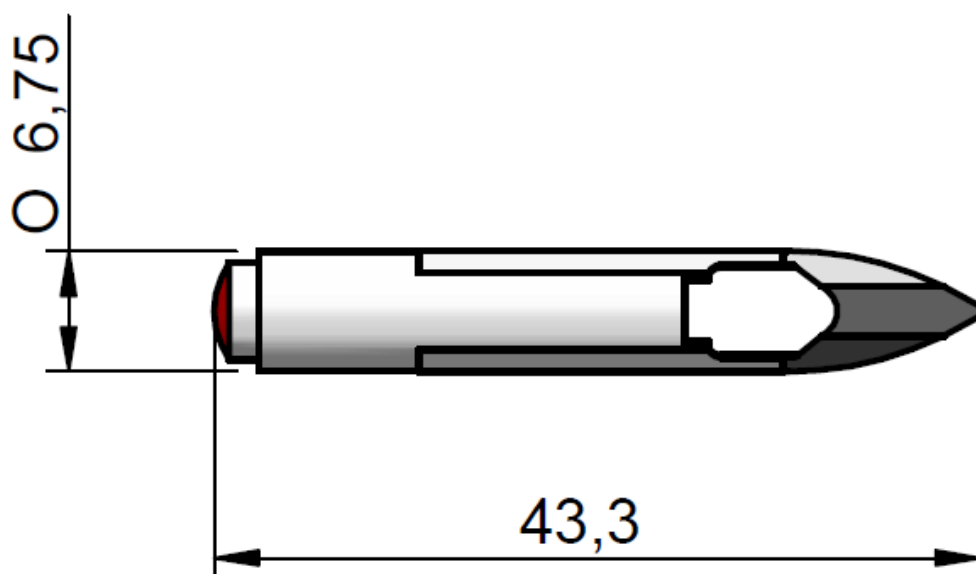

Specifications:

LED/Multiled	<i>Multiled</i>	Optimum voltage (V)	<i>28vdc</i>	Intensity	<i>45mcd</i>
Mounting Size		Rectifier			
Mounting Finish		AC current			
Protection		DC current	<i>15mA</i>		
Mount Holder	<i>T6.8</i>	Voltage Tolerance(%)	<i>10%</i>		
Chip Qty	<i>6</i>	Optimum temperature (°C)	<i>-30°C...+60°C</i>		
Indicator colour	<i>Red</i>	Storage temperature (°C)	<i>-30°C...+60°C</i>		
Wavelength (nm)	<i>635</i>	Contact Tab x 2	<i>T6.8 Slide Base</i>		