

15W AC to DC Converter PCB Mount

**RoHS
Compliant**

15W, AC-DC converter



Features

- Ultra-wide 85 - 305VAC and 100 - 430V DC input voltage range
- Operating ambient temperature range: -40°C to +85°C
- Up to 86% efficiency
- No-load power consumption <0.1W
- 5000m altitude application
- EMI performance meets CISPR32 / EN55032 CLASS B
- Design to meet IEC/EN/UL62368/EN60335/EN61558 standards
- Design to meet IEC/EN60601-1/ANSI/AAMI ES60601-1 standards (2xMOPP)
- 3 years warranty

Description

MP-LD15-23BxxR2 series AC-DC converters is one of new generation compact size power converter. It features ultra-wide AC input and at the same time accepts DC input voltage, low power consumption, low ripple & noise, high efficiency, high reliability, reinforced isolation. It offers good EMC performance compliant to IEC/EN61000-4 and CISPR32/EN55032 and meets IEC/EN/UL62368/EN60335/ EN61558/IEC/EN60601-1/ANSI/AAMI ES60601-1 standards. The converters are widely used in industrial, power, medical treatment, home appliances, instrumentation, communication and civil applications. For extremely harsh EMC environment, we recommend using the application circuit show in Design Reference of this datasheet.

Selection Guide				
Part Number	Output Power	Nominal Output Voltage and Current	Efficiency at 230VAC (%) Typ.	Capacitive Load (µF) Max.
MP-LD15-23B03R2	13.2W	3.3V/4000mA	82	6600
MP-LD15-23B05R2*	15W	5V/3000mA	85	5000
MP-LD15-23B09R2		9V/1670mA	84	3000
MP-LD15-23B12R2		12V/1250mA	85	2000
MP-LD15-23B24R2		24V/625mA	86	680

Note*

A2S suffix donates chassis mount option. For dimensions see page 6 of the datasheet.

Input Specifications					
Item	Operating Conditions	Min.	Typ.	Max.	Unit
Input Voltage Range	AC input	85	-	305	V AC
	DC input	100		430	V DC
Input Frequency		47		63	Hz
Input Current	115V AC	-		0.45	A
	230V AC			0.3	
Inrush Current	115V AC		60	--	
	230V AC				
Leakage Current	277V AC/50Hz		0.1mA RMS Max.		
Built In Fuse		2A/300V, slow-blow			
Hot Plug		Unavailable			

15W AC to DC Converter PCB Mount



Output Specifications						
Item	Operating Conditions		Min.	Typ.	Max.	Unit
Output Voltage Accuracy			--	±2	-	%
Line Regulation	Full load		--	±0.5	-	
Load Regulation	0%-100% load		--	±1	-	
Ripple & Noise*	20MHz bandwidth (peak-to-peak value)		--	70	120	mV
Stand-by Power Consumption	230V AC	3.3/5/9/12V	--	--	0.1	W
		24V	--	--	0.12	
Temperature Coefficient			--	±0.02	-	%/°C
Short-circuit Protection			Hiccup, continuous, self-recovery			
Over-current Protection			≥110%Io, self-recovery			
Over-voltage Protection	3.3/5V		≤7.5VDC (Output voltage clamp or hiccup)			
	9V		≤15VDC (Output voltage clamp or hiccup)			
	12V		≤20VDC (Output voltage clamp or hiccup)			
	24V		≤30VDC (Output voltage clamp or hiccup)			
Minimum Load			0	-	-	%
Hold-up Time	115V AC input		-	10	-	ms
	230V AC input		-	55	-	

Notes: *The "Tip and barrel method" is used for ripple and noise test, output parallel 10uF electrolytic capacitor and 1uF ceramic capacitor, please refer to AC-DC Converter Application Notes for specific information.

General Specifications

Item	Operating Conditions		Min.	Typ.	Max.	Unit
Isolation	Input-Output	Electric Strength Test for 1min, leakage current <5mA	4000	-	-	V AC
Insulation Resistance	Input-Output	At 500V DC	100	-	-	MΩ
Operating Temperature			-40	-	+85	°C
Storage Temperature				-		
Storage Humidity			-	-	95	%RH
Soldering Temperature	Wave-soldering		260 ± 5°C; time: 5 - 10s			
	Manual-welding		360 ± 10°C; time: 3 - 5s			
Switching Frequency			-	65	-	kHz
Power Derating	-50°C to -70°C	3.3/5V	3	-	-	% / °C
	+55°C to +70°C	9/12/24V	2.67	-	-	
	+70°C to +85°C		1.33	-	-	
	85V AC to 100V AC		0.66	-	-	% / V AC
	277V AC to 305V AC		0.71	-	-	
	2000m - 5000m		0.67	-	--	
Safety Standard			IEC/EN/UL62368/EN60335/EN61558/ IEC/EN60601-1/ANSI/AAMI ES60601-1			

15W AC to DC Converter PCB Mount

Item	Operating Conditions		Min.	Typ.	Max.	Unit
Safety Certification			IEC/EN/UL62368/EN60335/EN61558(Pending)			
Safety Class			CLASS II			
MTBF			MIL-HDBK-217F@25°C > 3200,000 h			
Designed Life	230V AC	Ta:25°C 100% load	>130 × 10 ³ h			
		Ta: 55°C 100% load	>27 × 10 ³ h			

Mechanical Specifications		
Case Material	Black plastic; flame-retardant and heat-resistant (UL94 V-0)	
Dimensions	DIP package	47.6mm × 26.8mm × 23.5mm
Weight	DIP	48g (Typ.)
Cooling Method	Free air convection	

Electromagnetic Compatibility (EMC)				
Emissions	CE	CISPR32/EN55032	CLASS B	
		CISPR11/EN5501	CLASS B	
		EN55014-1		
	RE	CISPR32/EN55032	CLASS B	
		CISPR11/EN55011	CLASS B	
		EN55014-1		
Immunity	ESD	IEC/EN61000-4-2	Contact ± 8KV	perf. Criteria B
		EN55014-2		perf. Criteria B
	RS	IEC/EN61000-4-3	10V/m	perf. Criteria A
		EN55014-2		perf. Criteria A
	EFT	IEC/EN61000-4-4	±2KV	perf. Criteria B
		IEC/EN61000-4-4	±4KV (See Fig.2 for recommended circuit)	perf. Criteria B
		EN55014-2		perf. Criteria B
	Surge	IEC/EN61000-4-5	line to line ±1KV	perf. Criteria B
		IEC/EN61000-4-5	line to line ±2KV (See Fig.2 for recommended circuit)	
		EN55014-2		perf. Criteria B
	CS	IEC/EN61000-4-6	10Vr.m.s	perf. Criteria A
		EN55014-2		perf. Criteria A
Voltage dip, short interruption and voltage variation	IEC/EN61000-4-11	0%, 70%	perf. Criteria B	
	EN55014-2		perf. Criteria B	

15W AC to DC Converter PCB Mount

Product Characteristic Curve

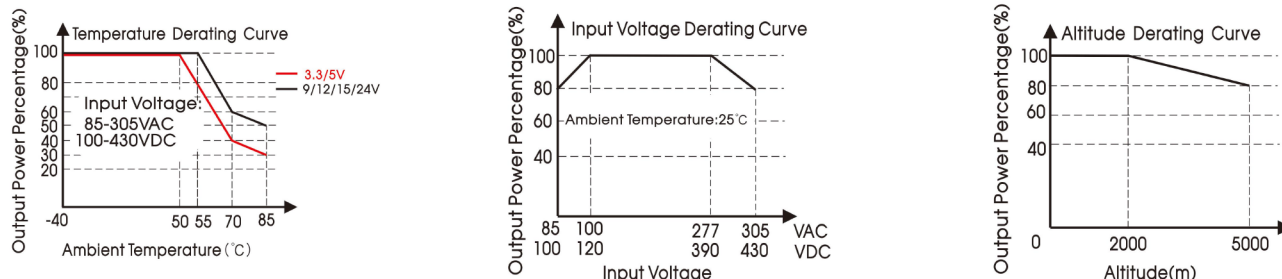

Note: ① With an AC input between 85-100V/277-305VAC and a DC input between 100-120V/390-430VDC, the output power must be derated as per temperature derating curves;
 ② This product is suitable for applications using natural air cooling; for applications in closed environment please consult factory or one of our FAE.

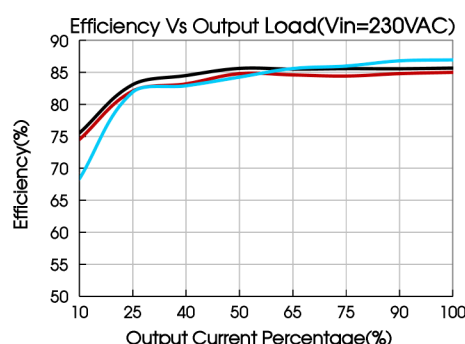
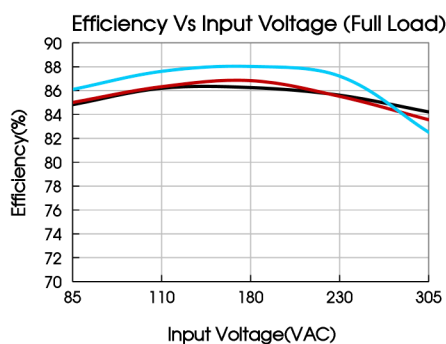

Design Reference

1. Typical application

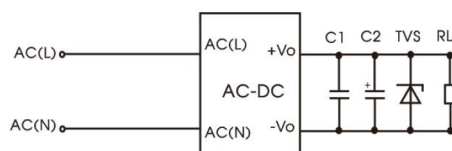

Fig. 1: Typical circuit diagram

Part Number	C1(μF)	C2(μF)	TVS
MP-LD15-23B03R2	1μF/50V	220μF/16V	SMBJ7A
MP-LD15-23B05R2			
MP-LD15-23B09R2		100μF/25V	SMBJ12A
MP-LD15-23B12R2			SMBJ20A
MP-LD15-23B24R2			100μF/35V

Output Filter Components:

We recommend using an electrolytic capacitor with high frequency, and low ESR rating for C2 (refer to manufacture's datasheet). Choose a Capacitor voltage rating with at least 20% margin, in other words not exceeding 80%. C1 is a ceramic capacitor used for filtering high-frequency noise and TVS is a recommended suppressor diode to protect the application in case of a converter failure.

15W AC to DC Converter PCB Mount

2. EMC compliance recommended circuit

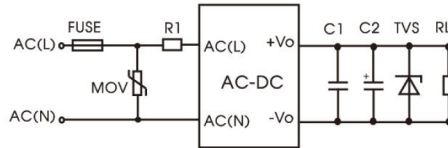
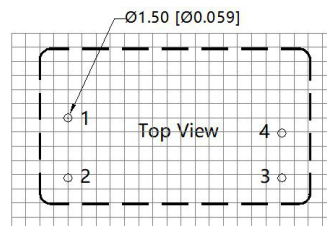
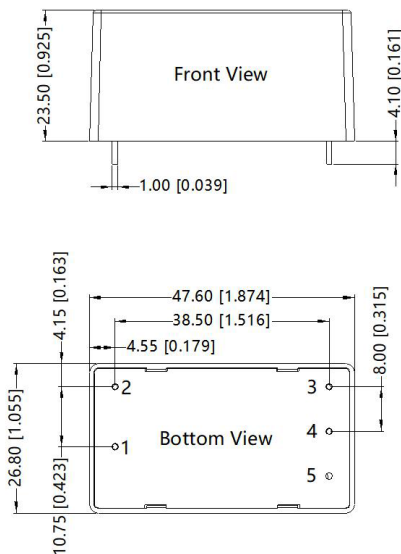

Fig 2: EMC application circuit with higher requirements

Component	Recommended value
MOV	S14K350
R1	6.8Ω/3W
FUSE	3.15A/300V, slow-blow, required

Dimensions and Recommended Layout

THIRD ANGLE PROJECTION



Note: Grid 2.54*2.54mm

Pin-Out	
Pin	Function
1	AC(L)
2	AC(N)
3	-Vo
4	+Vo
5	No Pin

Note:
 Unit: mm[inch]
 Pin diameter tolerances: $\pm 0.10[\pm 0.004]$
 General tolerances: $\pm 0.50[\pm 0.020]$

Dimensions : Millimetres

15W AC to DC Converter PCB Mount

A2S Dimensions (chassis mount option)

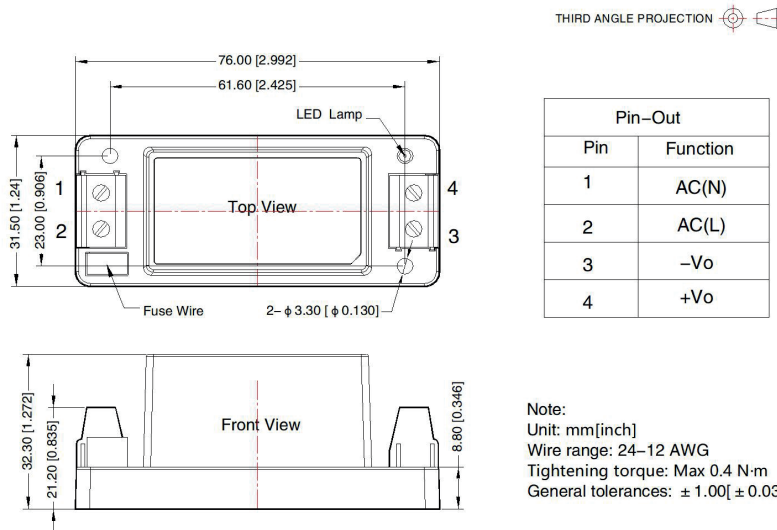

Part Number Table

Description	Part Number
15W AC/DC Converter, PCB, 3.3V/4000mA	MP-LD15-23B03R2
15W AC/DC Converter, PCB, 5V/3000mA	MP-LD15-23B05R2
15W AC/DC Converter, PCB, 9V/1670mA	MP-LD15-23B09R2
15W AC/DC Converter, PCB, 12V/1250mA	MP-LD15-23B12R2
15W AC/DC Converter, PCB, 24V/625mA	MP-LD15-23B24R2

Important Notice : This data sheet and its contents (the "Information") belong to the members of the AVNET group of companies (the "Group") or are licensed to it. No licence is granted for the use of it other than for information purposes in connection with the products to which it relates. No licence of any intellectual property rights is granted. The Information is subject to change without notice and replaces all data sheets previously supplied. The Information supplied is believed to be accurate but the Group assumes no responsibility for its accuracy or completeness, any error in or omission from it or for any use made of it. Users of this data sheet should check for themselves the Information and the suitability of the products for their purpose and not make any assumptions based on information included or omitted. Liability for loss or damage resulting from any reliance on the Information or use of it (including liability resulting from negligence or where the Group was aware of the possibility of such loss or damage arising) is excluded. This will not operate to limit or restrict the Group's liability for death or personal injury resulting from its negligence. Multicomp Pro is the registered trademark of Premier Farnell Limited 2019.