



Low Voltage Products

ABB Low Voltage Essentials Industrial & Automation Products

ABB Low Voltage Essentials

Industrial & Automation Products

Within this catalogue, you will find products for industrial and automation applications available from stock from ABB Low Voltage Products in the UK and via our expanding distributor network which can be located in the links section of our website: <http://www.abb.co.uk/lowvoltage>

Our global range of Low Voltage Products not covered in our Low Voltage Essentials stock product catalogues are available on factory lead times. See overleaf for our complete range of technical catalogues. Alternatively please visit our website: <http://www.abb.co.uk/lowvoltage>

As well as our range of industrial products contained in this catalogue, we have a comprehensive range of contractor/wholesaler products too, with the same emphasis on providing items from stock, all of which are included in our catalogue **Low Voltage Essentials - Contractor/Installer Products**.

ABB has a reputation for manufacturing and supplying quality low voltage components, the result of our on-going research and development programme. Our product ranges are supported by full and extensive technical documentation and the page opposite shows some of the major supporting catalogues. In addition, a visit to our website at <http://www.abb.co.uk/lowvoltage> will provide you with a wealth of product information including catalogue downloads, cad drawings and product configurators.”



Industrial LV Essentials

<http://view.digi-page.net/?id=1TXD000001P0210>



Contractor LV Essentials

<http://view.digi-page.net/?id=1TXD00000P0209>

To view these publications on line with our turning page technology type the URLs into your web browser, you do not have to download pdf files. Save the URLs in your favourites for future viewing.

ABB Low Voltage Technical Publications

Integrated Control Range



1SBC100155C0201

New

Block Contactors



1SBC100122C0202

Pilot Devices



1SFC151003C0201

Soft Starters



1SFC132004C0201

Relay & Timers



2CDC110004C0206

Installation Equipment



2CSC400002D0208

KNX Equipment



2CDC500007B0207

Wiring Accessories



1SXF610007C0201

Watchdog PIRs



9AKK104295D5667

MCCBs



1SDC210015D0204

ACBs



1SDC200006D0207

Our main technical catalogues are illustrated on this page.
Visit the ABB Library at:
<http://www.abb.com/abblibrary/DownloadCenter/>
or enter the catalogue part number into a search engine to
download the catalogue(s) you require.

Switch Fuses



1SCC311013C0201

Switch Disconnectors



1SCC301001C0201

Changeover Switches



1SCC303003C0201

XR SlimLine Switch Fuses



1SEC311001C0201

Cam Switches



1SCC302003C0201

5000 Series



1SNC160001C0207

SNK Series



1SNK161001C0201

New



Contractor LV Essentials

1TXD00000P0209

General Information

Strategic Partners

We have created two dedicated publications focussing on our core products for industrial automation and contractor/installer markets.

You will find information on our stocked products including brief technical specification, short code, order code and product hierarchy. (Example below)

Measuring & Monitoring Relays		Product Hierarchy 400004	
Description	Order Code	Price	
CM-MSS Thermistor motor protection relay , 2x1c/o, 24-240VAC/DC	1SVR430710R0200	98.76	
CM-MSS Thermistor motor protection relay , 2c/o, 24VAC/DC	1SVR430710R9300	45.33	
CM-MSS Thermistor motor protection relay , 2c/o, 110-130VAC	1SVR430711R0300	45.33	
CM-MSS Thermistor motor protection relay , 2c/o, 380-415VAC	1SVR430711R2300	51.87	

The Product Hierarchy has been included to assist in identifying discounts for particular product ranges when used in conjunction with the customer discount structure file.

By focusing on core products, we are confident that the majority of your requirements can be satisfied from stock by selecting products from the Low Voltage Essentials catalogues. Of course, our full range of products is still available to you, but on factory lead times.

We have also included complimentary items that support other products in our range. These products are not normally stocked.

As a customer, you can also take advantage of the services provided by our web based on-line solutions, MyABB.



From this portal you can obtain price and availability, check order status, obtain copy documentation and place orders on-line 24/7/365. If you have not already registered, you can do this by talking to your local ABB sales engineer.

Contact Us

Knowledge Base

General Enquiries: LV.Enquiries@gb.abb.com
Customer Services: LV.CustomerService@gb.abb.com
Technical: LV.TechnicalSupport@gb.abb.com

Sales Desk

To find your nearest stockists, please visit:
<http://www.abb.co.uk/lowvoltage>



Telephone: 02476 368676
Facsimile: 02476 368401
Credit Control: 01480 475321

If you already have an account you can place orders:
Online: <http://online.abb.com/bol>
Email: orders.lvp@gb.abb.com
Facsimile: 02476 368401



Tower Court
Foleshill Enterprise Park
Courtaulds Way
Coventry
CV6 5NX



This price list supercedes all previously issued prices.

All prices are in £'s Sterling and do not include VAT.

Every effort has been made to ensure that the information given in this publication is correct, and we accept no liability in respect of contingencies arising from errors.

All goods are offered subject to our Terms of Tender and Sale, Form TS.2c see pages 13/84

Easy View Product Finder

New AF Range
Available September 2010

Control 1



AF Series contactors
2



A & EK contactors
10



Mini Contactors
24



Manual Motor Starters
26

Line Protection 2



Compact S200 Series
44



Compact 800 Series
51



Compact RCCBs
52



Compact RCDs
53

Power Breakers 3



Tmax T1 ... T7
60

Switchgear 4

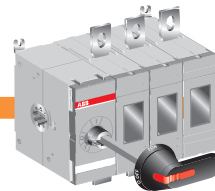
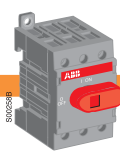

SwitchLine Disconnectors
78

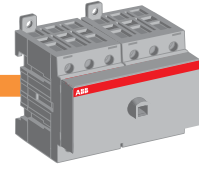

SwitchLine Changeover Switches
86

Enclosures 5



Sheet Steel Enclosures
98



Gemini Enclosures
99

Terminals 6



Feed Through Terminals
104



SNK Terminals
142



Soft Starters
28



Pilot Devices
29



Electronic Relays
Timers 34



S271 RCBOs
54



Compact Energy
Meters 57



Compact Modular
Devices 58



X Series ACBs
73



E Series ACBs
73



PowerLine Switch
Fuses 86



SlimLine Switch
Disconnectors 95



CamLine
Cam Switches 96



*The integrated product
range for the system builder*



Control Gear

Control Gear

New AF Series Block Contactors 2 - 9

A and EK Series 3 & 4 Pole Block Contactors..... 10 - 23

Mini Contactors..... 24 - 25

Manual Motor Starters..... 26 - 27

Soft Starters..... 28

Pilot Devices..... 29 - 33

Electronic Relays & Timers 34 - 41



New AF Range
Available September 2010

New Range Contactors



Full range of product and technical information place this part number in a search engine and download
1SBC100155C0201

Block Contactors



Full range of product and technical information place this part number in a search engine and download
1SBC100122C0202

Pilot Devices



Full range of product and technical information place this part number in a search engine and download
1SFC151003C0201

Soft Starters



Full range of product and technical information place this part number in a search engine and download
1SFC132004C0201

Relay & Timers



Full range of product and technical information place this part number in a search engine and download
2CDC110004C0206



Motor Protection and Control up to 18kW/20hp

Overview

1

- Harmonised design and colour
- Modular and compact
- Low energy consumption
- Small number of components
- Minimum need for accessories
- Optimised wiring and configuration
- High ratings and service capability
- Increased application possibilities
- Reliable and experienced



Starters Protected by Manual Motor Starters

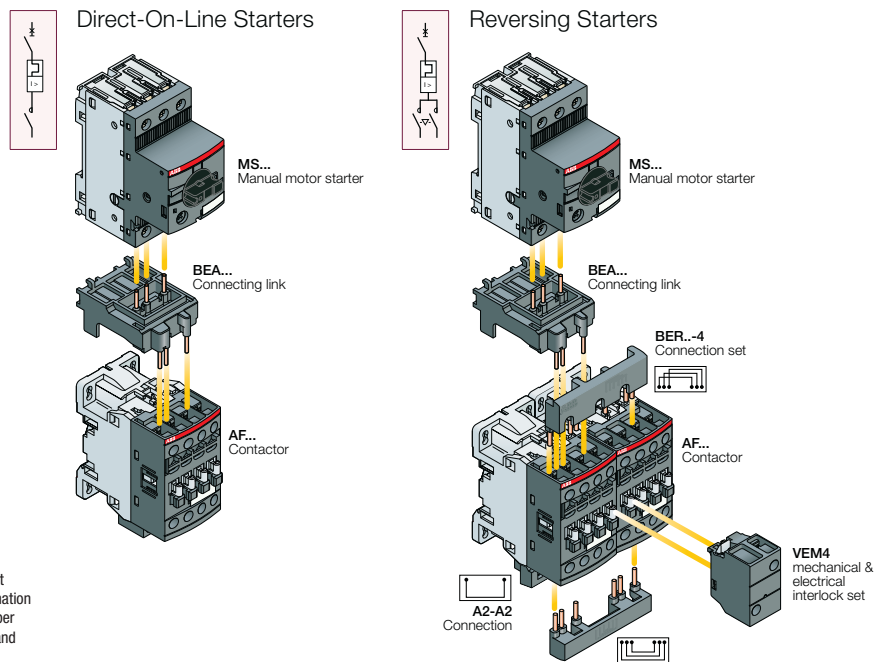

Full range of product and technical information place this part number in a search engine and download
1SBC100155C0201



Motor Protection and Control up to 18kW/20hp

Overview

Starters Protected by Thermal Overload Relays

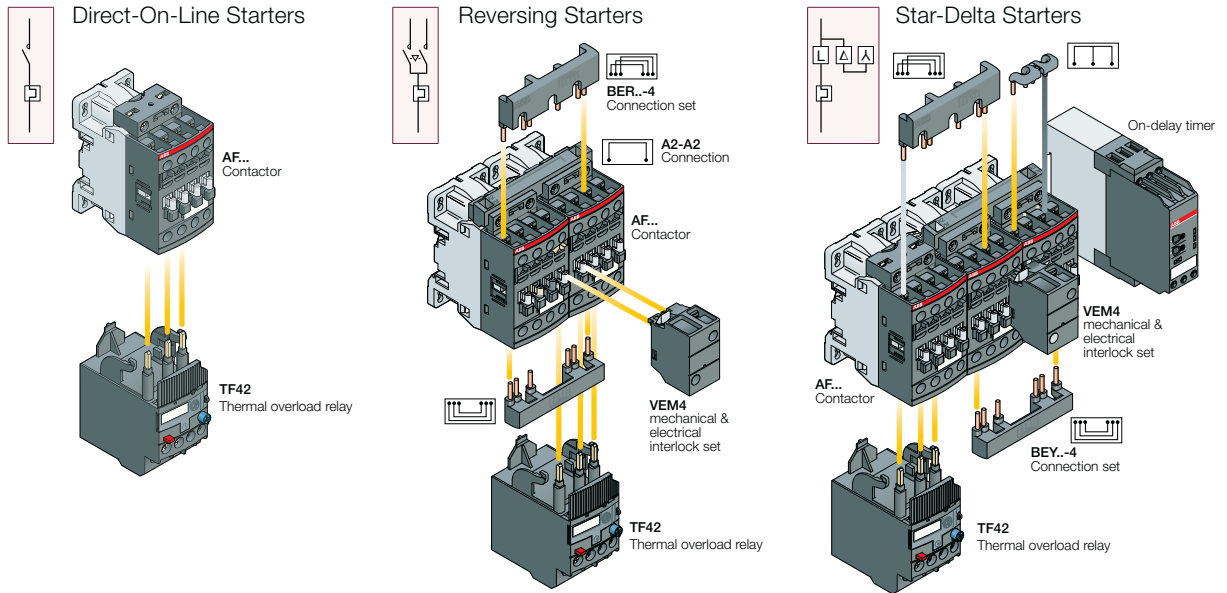

Greater flexibility with fewer components



Meets all relevant electrical standards



Allows the design engineer greater flexibility



Reliability of operation through years of experience



Full range of product and technical information place this part number in a search engine and download
1SBC100155C0201

3 Pole Block Contactors

for all industrial applications
and motor starting

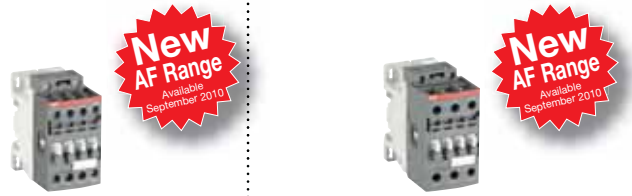

IEC	AC-3 Rated Power	$\theta \leq 55^\circ\text{C}$, 400 V	kW	4	5.5	7.5	11	15	18.5
UL/CSA	3-phase Motor Power	480 V	hp	5	7.5	10	15	20	20
AC Control Supply			Type	AF09	AF12	AF16	AF26	AF30	AF38
DC Control Supply			Type	AF09	AF12	AF16	AF26	AF30	AF38
AC / DC Control Supply			Type	AF09	AF12	AF16	AF26	AF30	AF38
IEC	AC-3 Rated Current	$\theta \leq 55^\circ\text{C}$, 400 V	A	9	12	18	26	32	38
	AC-1 Rated Current	$\theta \leq 40^\circ\text{C}$, 690 V	A	25	28	30	45	50	50
UL/CSA	NEMA Size			00	0	—	1	—	—
	General Use Rating	600 V	A	25	28	30	45	50	50

Main Accessories

Auxiliary Contact Blocks	Front mounting	CA4-10 (1 x N.O.)	CA4-01 (1 x N.C.)
	Side mounting	CAL4-11 (1 x N.O. + 1 x N.C.)	
Timers	Pneumatic (Front mounting)		
	Electronic*		
Interlocking Units	Mechanical	VM4	
	Mechanical / Electrical	VEM4	
Connection Sets	For reversing contactors	BER16-4	BER38-4
Surge Suppressors	Varistor (AC/DC)		
	RC Type (AC)		
	Transil diode (DC)		

* AF contactors do not need TE5S electronic timer

Overload Relays

Thermal Relays		Class 10 (10A or 20 for TA42DU to TA80DU)	TF42	TF42
Electronic Relays		Class 10E, 20E, 30E	EF19 (0.10...18.9 A)	EF19 (0.10...18.9 A) EF45 (9...45 A)
Accessories for Thermal Overload Relays		Remote tripping coil		
		Remote reset coil		
		Wall/separate mounting kit		

Manual Motor Starters

Manual Motor Starters		Thermal / magnetic protection	Class 10	MS116 for class 10A (0.10...16 A) I _{cs} up to 50 kA	MS450 (11...50 A)
				MS132 (0.10...32 A) I _{cs} up to 100 kA	MS497 (11...100 A)
					MS451 (11...50 A)
		Magnetic only types			
Accessories		For contactor mounting	BEA16-4	BEA38-4	HK4, HKS4, UA4, AA4, PS4, S4, SK4
		Aux. trip units, aux. contacts, busbars	HKF1, HK1, UA1, AA1, PS1, S1, SK1, CK1 (MS132 only)		



AF9 ... AF12 contactors

AC/DC Operated with screw terminals

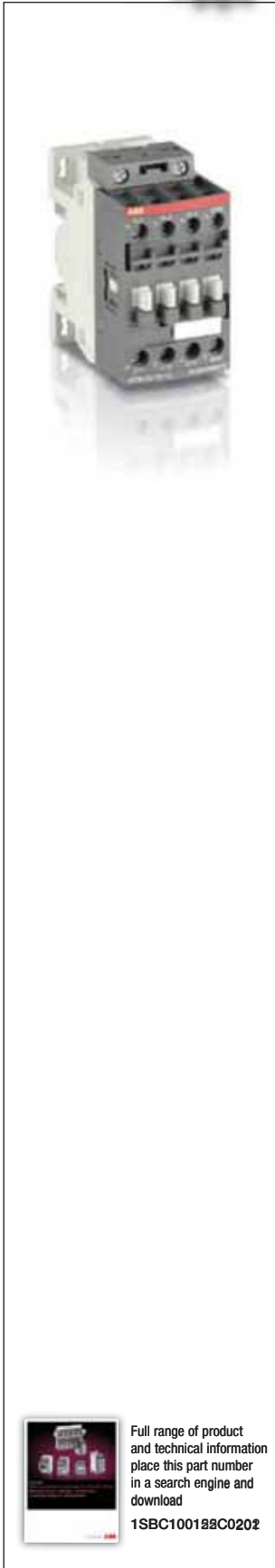

AF9 ... AF12 Contactors

Product Hierarchy 1700009

AC-3 400V kW	AC-3 400V A	AC-1 40°C A	Aux NO	Aux NC	Description	Order Code	Price £			
4	9	25	1	-	AF09-30-10-12 48-130V50/60HZ-DC	1SBL137001R1210	19.38			
					AF09-30-10-13 100-250V50/60HZ-DC	1SBL137001R1310	19.38			
					AF09-30-10-14 250-500V50/60HZ-DC	1SBL137001R1410	19.38			
					AF09Z-30-10-20 12-20VDC	1SBL136001R2010	38.55			
					AF09Z-30-10-21 24-60V50/60HZ 20-60VDC	1SBL136001R2110	38.55			
			-	1	AF09-30-01-12 48-130V50/60HZ-DC	1SBL137001R1201	19.38			
					AF09-30-01-13 100-250V50/60HZ-DC	1SBL137001R1301	19.38			
					AF09-30-01-14 250-500V50/60HZ-DC	1SBL137001R1401	19.38			
					AF09Z-30-01-20 12-20VDC	1SBL136001R2001	38.55			
					AF09Z-30-01-21 24-60V50/60HZ 20-60VDC	1SBL136001R2101	38.55			
		-	-	22	-	AF09-22-00-12 48-130V50/60HZ-DC	1SBL137501R1200	20.25		
						AF09-22-00-13 100-250V50/60HZ-DC	1SBL137501R1300	20.25		
						AF09-22-00-14 250-500V50/60HZ-DC	1SBL137501R1400	20.25		
						AF09Z-22-00-21 24-60V50/60HZ 20-60VDC	1SBL136501R2100	45.88		
				40	-	-	-	AF09-40-00-12 48-130V50/60HZ-DC	1SBL137201R1200	20.25
								AF09-40-00-13 100-250V50/60HZ-DC	1SBL137201R1300	20.25
								AF09-40-00-14 250-500V50/60HZ-DC	1SBL137201R1400	20.25
								AF09Z-40-00-20 12-20VDC	1SBL136201R2000	40.72
		AF09Z-40-00-21 24-60V50/60HZ 20-60VDC	1SBL136201R2100	40.72						
		5.5	12	27	1	-	AF12Z-30-10-20 12-20VDC	1SBL156001R2010	40.72	
AF12-30-10-12 48-130V50/60HZ-DC	1SBL157001R1210						23.37			
AF12-30-10-13 100-250V50/60HZ-DC	1SBL157001R1310						23.37			
AF12-30-10-14 250-500V50/60HZ-DC	1SBL157001R1410						23.37			
AF12Z-30-10-21 24-60V50/60HZ 20-60VDC	1SBL156001R2110						40.72			
-	1				AF12Z-30-01-20 12-20VDC	1SBL156001R2001	40.72			
					AF12-30-01-12 48-130V50/60HZ-DC	1SBL157001R1201	23.37			
					AF12-30-01-13 100-250V50/60HZ-DC	1SBL157001R1301	23.37			
					AF12-30-01-14 250-500V50/60HZ-DC	1SBL157001R1401	23.37			
					AF12Z-30-01-21 24-60V50/60HZ 20-60VDC	1SBL156001R2101	40.72			



Full range of product and technical information place this part number in a search engine and download
1SBC100122C0202



AF16 ... AF38 contactors

AC/DC Operated with screw terminals



AF16 ... AF38 Contactors

Product Hierarchy 1700009

AC-3 400V kW	AC-3 400V A	AC-1 40°C A	Aux NO	Aux NC	Description	Order Code	Price £			
7.5	17	30	1	-	AF16-30-10-12 48-130V50/60HZ-DC	1SBL177001R1210	30.86			
					AF16-30-10-13 100-250V50/60HZ-DC	1SBL177001R1310	30.86			
					AF16-30-10-14 250-500V50/60HZ-DC	1SBL177001R1410	30.86			
					AF16Z-30-10-20 12-20VDC	1SBL176001R2010	53.08			
					AF16Z-30-10-21 24-60V50/60HZ 20-60VDC	1SBL176001R2110	53.08			
			-	1	AF16-30-01-12 48-130V50/60HZ-DC	1SBL177001R1201	30.86			
					AF16-30-01-13 100-250V50/60HZ-DC	1SBL177001R1301	30.86			
					AF16-30-01-14 250-500V50/60HZ-DC	1SBL177001R1401	30.86			
					AF16Z-30-01-20 12-20VDC	1SBL176001R2001	53.08			
					AF16Z-30-01-21 24-60V50/60HZ 20-60VDC	1SBL176001R2101	53.08			
			-	-	AF16-22-00-12 48-130V50/60HZ-DC	1SBL177501R1200	36.35			
					AF16-22-00-13 100-250V50/60HZ-DC	1SBL177501R1300	36.35			
					AF16-22-00-14 250-500V50/60HZ-DC	1SBL177501R1400	36.35			
					AF16Z-22-00-21 24-60V50/60HZ 20-60VDC	1SBL176501R2100	56.33			
			-	-	AF16-40-00-12 48-130V50/60HZ-DC	1SBL177201R1200	32.60			
					AF16-40-00-13 100-250V50/60HZ-DC	1SBL177201R1300	32.60			
					AF16-40-00-14 250-500V50/60HZ-DC	1SBL177201R1400	32.60			
					AF16Z-40-00-20 12-20VDC	1SBL176201R2000	54.57			
								AF16Z-40-00-21 24-60V50/60HZ 20-60VDC	1SBL176201R2100	54.57
			11	26	45	-	-	AF26-30-00-12 48-130V50/60HZ-DC	1SBL237001R1200	40.07
AF26-30-00-13 100-250V50/60HZ-DC	1SBL237001R1300	40.07								
AF26-30-00-14 250-500V50/60HZ-DC	1SBL237001R1400	40.07								
AF26Z-30-00-20 12-20VDC	1SBL236001R2000	61.40								
AF26Z-30-00-21 24-60V50/60HZ 20-60VDC	1SBL236001R2100	61.40								
15	32	55	-	-	AF30-30-00-12 48-130V50/60HZ-DC	1SBL277001R1200	61.77			
					AF30-30-00-13 100-250V50/60HZ-DC	1SBL277001R1300	61.77			
					AF30-30-00-14 250-500V50/60HZ-DC	1SBL277001R1400	61.77			
					AF30Z-30-00-20 12-20VDC	1SBL276001R2000	80.63			
					AF30Z-30-00-21 24-60V50/60HZ 20-60VDC	1SBL276001R2100	80.63			
18.5	35	60	-	-	AF38-30-00-12 48-130V50/60HZ-DC	1SBL297001R1200	76.79			
					AF38-30-00-13 100-250V50/60HZ-DC	1SBL297001R1300	76.79			
					AF38-30-00-14 250-500V50/60HZ-DC	1SBL297001R1400	76.79			
					AF38Z-30-00-20 12-20VDC	1SBL296001R2000	91.19			
					AF38Z-30-00-21 24-60V50/60HZ 20-60VDC	1SBL296001R2100	91.19			



Full range of product and technical information place this part number in a search engine and download
1SBC100122C0202



NF contactor relays

AC/DC Operated with screw terminals



NF Contactor Relays

NF Contactor Relays			Product Hierarchy 1700009	
NO	NC	Part No	Order Code	Price £
2	2	NF22E-12 48-130V50/60HZ-DC	1SBH137001R1222	19.59
		NF22E-13 100-250V50/60HZ-DC	1SBH137001R1322	19.59
		NFZ22E-21 24-60V50/60HZ 20-60VDC	1SBH136001R2122	40.20
3	1	NF31E-12 48-130V50/60HZ-DC	1SBH137001R1231	19.59
		NF31E-13 100-250V50/60HZ-DC	1SBH137001R1331	19.59
		NFZ31E-21 24-60V50/60HZ 20-60VDC	1SBH136001R2131	40.20
4	-	NF40E-12 48-130V50/60HZ-DC	1SBH137001R1240	19.59
		NF40E-13 100-250V50/60HZ-DC	1SBH137001R1340	19.59
		NFZ40E-21 24-60V50/60HZ 20-60VDC	1SBH136001R2140	40.20



Full range of product and technical information place this part number in a search engine and download
1SBC100155C0201



AF09 ... AF38 Main Accessories

for contactors and relays



Front mounted instantaneous auxiliary contacts

For Contactor	NO	NC	Part No.	Product Hierarchy 1700009	
				Order Code	Price
AF09 ... AF38	1	0	CA4-10	1SBN010110R1010	2.82
	1	0	CA4-10-T	1SBN010110T1010	2.82
	0	1	CA4-01	1SBN010110R1001	2.82
	0	1	CA4-01-T	1SBN010110T1001	2.82
AF09 ... AF16-30-10	2	2	CA4-22M	1SBN010140R1122	10.08
	3	1	CA4-31M	1SBN010140R1131	10.08
	1	3	CA4-13M	1SBN010140R1113	10.08
	0	4	CA4-04M	1SBN010140R1104	10.08
AF26 ... AF38-30-00	2	2	CA4-22E	1SBN010140R1022	10.08
	3	1	CA4-31E	1SBN010140R1031	10.08
	4	0	CA4-40E	1SBN010140R1040	10.08
	0	4	CA4-04E	1SBN010140R1004	10.08
AF09 ... AF16-30-10	2	2	CA4-22U	1SBN010140R1322	10.08
	3	1	CA4-31U	1SBN010140R1331	10.08
	4	0	CA4-40U	1SBN010140R1340	10.08

Front mounted auxiliary contacts with NO leading and NC lagging

AF09 ... AF38	1	0	CC4-10	1SBN010111R1010	8.56
	0	1	CC4-01	1SBN010111R1001	8.56

Side mounted instantaneous auxiliary contacts

AF09 ... AF38	1	1	CAL4-11	1SBN010120R1011	6.40
	1	1	CAL4-11-T	1SBN010120T1011	6.40

Front mounted instantaneous auxiliary contacts with A1/A2 terminal blocks

AF09 ... AF16-30-10	1	1	CAT4-11E	1SBN010151R1011	6.07
AF26 ... AF38-30-00	1	1	CAT4-11M	1SBN010151R1111	6.07
AF09 ... AF16-30-10	1	1	CAT4-11U	1SBN010151R1311	6.07

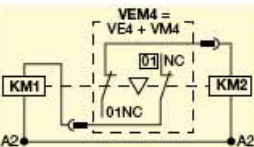

Add on Mechanical Interlocks

		Product Hierarchy 1700009	
Mechanical and Electrical Interlock Unit	VEM4	1SBN030111R1000	11.30
Mechanical Interlock Unit	VM4	1SBN030105T1000	6.04

Connecting Links

		Product Hierarchy 1700009	
Connecting Link	BEA16-4	1SBN081306T1000	3.61
Connecting Link	BEA38-4	1SBN082306T2000	4.39
Connection kit for PSR24-30 and MS132	PSR30-MS132	1SFA896212R1001	12.09
Connection Set for Reversing Starter	BER16-4	1SBN081311R1000	7.43
Connection Set for Reversing Starter	BER38-4	1SBN082311R1000	10.24
Connection Set for Star-Delta Starter	BEY16-4	1SBN081313R2000	11.64
Connection Set for Star-Delta Starter	BEY38-4	1SBN082713R2000	15.97



Full range of product and technical information place this part number in a search engine and download
1SBC100155C0201

Overload Protection



EF19



EF45

Electronic Overload Relays

Setting [A]	Part No	Product Hierarchy 1700006	
		Order Code	Price
0.10...0.32 A	EF19-0.32	1SAX121001R1101	51.91
0.30...1.00 A	EF19-1.0	1SAX121001R1102	51.91
0.80...2.70 A	EF19-2.7	1SAX121001R1103	51.91
1.90...6.30 A	EF19-6.3	1SAX121001R1104	54.87
5.70...18.9 A	EF19-18.9	1SAX121001R1105	54.87
9.00...30.0 A	EF45-30	1SAX221001R1101	81.52
15.0...45.0 A	EF45-45	1SAX221001R1102	98.48

Thermal Overload Relays

0.10...0.13 A	TF42-0.13	1SAZ721201R1005	25.50
0.13...0.17 A	TF42-0.17	1SAZ721201R1008	25.50
0.17...0.23 A	TF42-0.23	1SAZ721201R1009	25.50
0.23...0.31 A	TF42-0.31	1SAZ721201R1013	25.50
0.31...0.41 A	TF42-0.41	1SAZ721201R1014	25.50
0.41...0.55 A	TF42-0.55	1SAZ721201R1017	25.50
0.55...0.74 A	TF42-0.74	1SAZ721201R1021	25.50
0.74...1.00 A	TF42-1.0	1SAZ721201R1023	25.50
1.00...1.30 A	TF42-1.3	1SAZ721201R1025	25.50
1.30...1.70 A	TF42-1.7	1SAZ721201R1028	25.50
1.70...2.30 A	TF42-2.3	1SAZ721201R1031	25.50
2.30...3.10 A	TF42-3.1	1SAZ721201R1033	25.50
3.10...4.20 A	TF42-4.2	1SAZ721201R1035	25.50
4.20...5.70 A	TF42-5.7	1SAZ721201R1038	25.50
5.70...7.60 A	TF42-7.6	1SAZ721201R1040	25.50
7.60...10.0 A	TF42-10	1SAZ721201R1043	25.50
10.0...13.0 A	TF42-13	1SAZ721201R1045	26.58
13.0...16.0 A	TF42-16	1SAZ721201R1047	31.84
16.0...20.0 A	TF42-20	1SAZ721201R1049	32.95
20.0...24.0 A	TF42-24	1SAZ721201R1051	41.82
24.0...29.0 A	TF42-29	1SAZ721201R1052	44.24
29.0...35.0 A	TF42-35	1SAZ721201R1053	46.66
35.0...38.0 A	TF42-38	1SAZ721201R1055	46.66









Full range of product and technical information place this part number in a search engine and download

1SBC100155C0201

3 Pole Block Contactors (see also New AF Range page 4 onwards - Available from September 2010)

3-pole Block Contactors

														
IEC	AC-3 Power Rating	$\theta \leq 55^\circ\text{C}$, 400 V	kW	4	5.5	7.5	11	15	18.5	22	30	37	45	55
UL/CSA	3-phase Motor Rating	480 V	hp	5	7.5	10	20	25	30	40	60	60	60	75
a.c. Control Supply			Type	A 9	A 12	A 16	A 26	A 30	A 40	A 50	A 63	A 75	A 95	A 110
d.c. Control Supply			Type	AL 9	AL 12	AL 16	AL 26	AL 30	AL 40	AE 50	AE 63	AE 75	AE 95	AE 110
a.c. / d.c. Control Supply			Type	-	-	-	-	-	-	AF 50	AF 63	AF 75	AF 95	AF 110
IEC	AC-3 Rated Current	$\theta \leq 55^\circ\text{C}$, 400 V	A	9	12	17	26	32	37	50	65	75	96	110
		$\theta \leq 55^\circ\text{C}$, 690 V	A	7	9	10	17*	21*	25*	35	43	46	65	82
	AC-1 Rated Current	$\theta \leq 40^\circ\text{C}$, 690 V	A	25	27	30	45	55	60	100	115	125	145	160
		$\theta \leq 55^\circ\text{C}$, 690 V	A	22	25	27	40	55	60	85	95	105	135	145
	$\theta \leq 70^\circ\text{C}$, 690 V	A	18	20	23	32	39	42	70	80	85	115	130	
UL/CSA	3-phase Motor Rating	480 V	hp	5	7.5	10	20	25	30	40	60	60	60	75
		600 V	A	21	25	30	40	50	60	80	90	105	125	140
	Nema Size		00	0	-	1	1P	-	2	-	3	-	-	
* For AL 26 ... AL 40, see the technical documentation														

Main Accessories

Auxiliary Contact Blocks	Front mounting (1 or 4-pole)	CA 5-10 (1 x N.O.)	CA 5-01 (1 x N.C.)	CA 5-40.. (4 x N.O.)	CA 5-31.. (3 x N.O. + 1 x N.C.)	CA 5-22.. (2 x N.O. + 2 x N.C.)
	Side mounting (2-pole)	CAL 5-11 (1 x N.O. + 1 x N.C.)	CAL 5-11 (1 x N.O. + 1 x N.C.)	CAL 5-11 (1 x N.O. + 1 x N.C.)	CAL 5-11 (1 x N.O. + 1 x N.C.)	CAL 18-11 (1 x N.O. + 1 x N.C.)
Timers	Pneumatic*	TP 40 DA, TP 180 DA Direct timing - Front mounting			TP 40 IA, TP 180 IA Inverse timing - Front mounting	
	Electronic**	TE55-.. Direct timing - Separate mounting	TE55-.. Direct timing - Separate mounting	TE55-.. Direct timing - Separate mounting	TE55-.. Direct timing - Separate mounting	TE55-.. Direct timing Separate mounting
Interlocking Units	Mechanical	VM 5-1	VM 5-1			
	Mechanical / Electrical	VE 5-1	VE 5-1	VE 5-2	VE 5-2	
Surge Suppressors**	Varistor (a.c./d.c.)	RV 5/.. (24 ... 440 V)	RV 5/.. (24 ... 440 V)	RV 5/.. (24 ... 440 V)	RV 5/.. (24 ... 440 V)	RV 5/.. (24 ... 440 V)
	RC Type (a.c.)	RC 5-1/.. (24 ... 440 V)	RC 5-1/.. (24 ... 440 V)	RC 5-2/.. (24 ... 440 V)	RC 5-2/.. (24 ... 440 V)	RC 5-2/.. (24 ... 440 V)
	Transil diode (d.c.)	RT 5/.. (12 ... 264 V)	RT 5/.. (12 ... 264 V)	RT 5/.. (12 ... 264 V)	RT 5/.. (12 ... 264 V)	RT 5/.. (12 ... 264 V)
Connection Sets	For reversing contactors	BER 16..	BER 40..	BEM 75-30	BEM 110-30	

* TP pneumatic timer not suitable for (T)AL contactors and (T)NL-E contactor relays

** AF contactors do not need TE55 electronic timer or extra surge suppressor

Overload Relays

Thermal Relays		Class 10A (10 A or 20 for TA 25 to TA 80)	TA 25 DU (0.1 ... 32 A)	TA 25 DU (0.1 ... 32 A)	TA 75 DU (18 ... 80 A)	TA 80 DU (29 ... 80 A)
				TA 42 DU (18 ... 42 A)		TA 110 DU (65 ... 110 A)
Electronic Relays		Class 10, 20, 30	E 16 DU (0.1 ... 18.9 A)	E 45 DU (9 ... 45 A)	E 80 DU (27 ... 80 A)	E 140 DU (50 ... 140 A)

Manual Motor Starters

	Thermal / magnetic protection	MS 116 (0.16 ... 16 A)	MS 450 (11 ... 50 A)	MS 495 (28 ... 100 A)	MS 495 (28 ... 100 A)		
		MS 325 (0.16 ... 25 A)					
Connecting Links	For contactor mounting	BEA 16/..	BEA 26/..	BEA 40/..	BEA 50/..	BEA 75/..	BEA 110..



Full range of product and technical information place this part number in a search engine and download

1SBC100122C0202

				
75 90	110 140 160	200 250	315 400 -	475 560 -
100 125	150 200 250	350 400	500 600 -	800 900 -
A 145 A 185	A 210 A 260 A 300	AF 400 AF 460	AF 580 AF 750 AF 1250	AF 1350 AF 1650 AF 2050
AF 145 AF 185	AF 210 AF 260 AF 300	AF 400 AF 460	AF 580 AF 750 AF 1250	AF 1350 AF 1650 AF 2050
AF 145 AF 185	AF 210 AF 260 AF 300	AF 400 AF 460	AF 580 AF 750 AF 1250	AF 1350 AF 1650 AF 2050
145 185 120 170	210 260 305 210 220 280	400 460 350 400	580 750 - 500 650 -	860 1050 - 800 950 -
250 275 230 250 180 180	350 400 500 300 350 400 240 290 325	600 700 500 600 400 480	800 1050 1260 700 875 1040 580 720 875	1350 1650 2050 1150 1450 - 1000 1270 -
100 125 230 250 4 -	150 200 250 300 350 400 - 5 -	350 400 550 650 - 6	500 600 - 750 900 1210 - 7 -	800 900 - 1350 1650 2100 - 8 -

CAL 18-11 (1x)	CAL 18-11 (1x N.O. + 1x N.C.)	CAL 18-11 (1x N.O. + 1x N.C.)	CAL 18-11 (1x N.O. + 1x N.C.)	CAL 18-11 (1x N.O. + 1x N.C.)
TE55-... Direct timing Separate mounting	TE55-... Direct timing - Separate mounting			
VM 300H	VM 300H	VM 750H	VM 750H	VM 1650H
RC-EH 300	RC-EH 300			
BEM 185-30	BEM 300-30	BEM 460-30	BEM 750-30	

TA 200 DU (66	TA 450 DU (130 ... 310 A)			
E 200 DU (60 ...	E 320 DU (100 ... 320 A)	E 500 DU (150 ... 500 A)	E 800 DU (250 ... 800 A)	E 1250 DU (375 ... 1250 A)

Block Contactors

A9 ... A16 ac operated

1



AC-3 400V kW	AC-3 400V A	AC-1 40°C A	Aux NO	Aux NC	Description	Product Hierarchy 1700003	
						Order Code	Price £
4	9	25	-	1	A9-30-01 110V 50/60Hz	1SBL141001R8401	19.38
					A9-30-01 220-230V 50Hz	1SBL141001R8101	19.38
					A9-30-01 230-240V 50Hz	1SBL141001R8801	19.38
					A9-30-01 24V 50/60Hz	1SBL141001R8101	19.38
			1	-	A9-30-10 110V 50/60Hz	1SBL141001R8410	19.38
					A9-30-10 220-230V 50Hz	1SBL141001R8010	19.38
					A9-30-10 230-240V 50Hz	1SBL141001R8810	19.38
					A9-30-10 24V 50/60Hz	1SBL141001R8110	19.38
					A9-30-10 400-415V 50Hz	1SBL141001R8610	19.38
			-	-	A9-40-00 110V 50/60Hz	1SBL141201R8400	20.25
					A9-40-00 220-230V 50Hz	1SBL141201R8000	20.25
					A9-40-00 230-240v 50Hz	1SBL141201R8800	20.25
					A9-40-00 24V 50/60Hz	1SBL141201R8100	20.25
					A9-40-00 400-415V 50Hz	1SBL141201R8600	20.25
					A9-22-00 110V 50/60Hz	1SBL141501R8400	20.25
			A9-22-00 230-240v 50Hz	1SBL141501R8800	20.25		

5.5	12	27	-	1	A12-30-01 110V 50/60Hz	1SBL161001R8401	23.37
					A12-30-01 220-230V 50Hz	1SBL161001R8001	23.37
					A12-30-01 230-240v 50Hz	1SBL161001R8801	23.37
					A12-30-01 24V 50/60Hz	1SBL161001R8101	23.37
			1	-	A12-30-10 110V 50/60Hz	1SBL161001R8410	23.37
					A12-30-10 220-230V 50Hz	1SBL161001R8010	23.37
					A12-30-10 230-240v 50Hz	1SBL161001R8810	23.37
					A12-30-10 24V 50/60Hz	1SBL161001R8110	23.37
A12-30-10 400-415V 50Hz	1SBL161001R8610	23.37					

7.5	17	30	-	1	A16-30-01 110V 50/60Hz	1SBL181001R8401	30.86
					A16-30-01 220-230V 50Hz	1SBL181001R8001	30.86
					A16-30-01 230-240v 50Hz	1SBL181001R8801	30.86
					A16-30-01 24V 50/60Hz	1SBL181001R8101	30.86
			1	-	A16-30-10 110V 50/60Hz	1SBL181001R8410	30.86
					A16-30-10 220-230V 50Hz	1SBL181001R8010	30.86
					A16-30-10 230-240v 50Hz	1SBL181001R8810	30.86
					A16-30-10 24V 50/60Hz	1SBL181001R8110	30.86
			A16-30-10 400-415V 50Hz	1SBL181001R8610	30.86		
			-	-	A16-40-00 110V 50/60Hz	1SBL181201R8400	32.60
					A16-40-00 220-230V 50Hz	1SBL181201R8000	32.60
					A16-40-00 230-240v 50Hz	1SBL181201R8800	32.60
					A16-40-00 24V 50/60Hz	1SBL181201R8100	32.60
			A16-40-00 400-415V 50Hz	1SBL181201R8600	32.60		
			-	-	A16-22-00 110V 50/60Hz	1SBL181501R8400	36.35
					A16-22-00 230-240v 50Hz	1SBL181501R8800	36.35
A16-22-00 24V 50/60Hz	1SBL181501R8100	36.35					



Full range of product and technical information place this part number in a search engine and download
1SBC100122C0202

Block Contactors

A26 ... A45 ac operated



Product Hierarchy 1700003

AC-3 400V kW	AC-3 400V A	AC-1 40°C A	Aux NO	Aux NC	Description	Order Code	Price £			
11	26	45	-	1	A26-30-01 110V 50/60Hz	1SBL241001R8401	42.89			
					A26-30-01 220-230V 50Hz	1SBL241001R8001	42.89			
					A26-30-01 230-240v 50Hz	1SBL241001R8801	42.89			
					A26-30-01 24V 50/60Hz	1SBL241001R8101	42.89			
			1	-	A26-30-10 110V 50/60Hz	1SBL241001R8410	42.89			
					A26-30-10 220-230V 50Hz	1SBL241001R8010	42.89			
					A26-30-10 230-240v 50Hz	1SBL241001R8810	42.89			
					A26-30-10 24V 50/60Hz	1SBL241001R8110	42.89			
					A26-30-10 400-415V 50Hz	1SBL241001R8610	42.89			
			-	-	A26-40-00 110V 50/60Hz	1SBL241201R8400	48.91			
					A26-40-00 230-240v 50Hz	1SBL241201R8800	48.91			
					A26-40-00 24V 50/60Hz	1SBL241201R8100	48.91			
			-	-	A26-22-00 110v 50/60Hz	1SBL241501R8400	55.11			
					A26-22-00 230-240v 50Hz	1SBL241501R8800	55.11			
			15	32	55	-	1	A30-30-01 110V 50/60Hz	1SBL281001R8401	64.59
								A30-30-01 220-230V 50Hz	1SBL281001R8001	64.59
A30-30-01 230-240v 50Hz	1SBL281001R8801	64.59								
A30-30-01 24V 50/60Hz	1SBL281001R8101	64.59								
1	-	A30-30-10 110V 50/60Hz				1SBL281001R8410	64.59			
		A30-30-10 220-230V 50Hz				1SBL281001R8010	64.59			
		A30-30-10 230-240v 50Hz				1SBL281001R8810	64.59			
		A30-30-10 24V 50/60Hz				1SBL281001R8110	64.59			
A30-30-10 400-415V 50Hz	1SBL281001R8610	64.59								
18.5	37	60	-	1	A40-30-01 110V 50/60Hz	1SBL321001R8401	79.61			
					A40-30-01 220-230V 50Hz	1SBL321001R8001	79.61			
					A40-30-01 230-240v 50Hz	1SBL321001R8801	79.61			
					A40-30-01 24V 50/60Hz	1SBL321001R8101	79.61			
			1	-	A40-30-10 110V 50/60Hz	1SBL321001R8410	79.61			
					A40-30-10 220-230V 50Hz	1SBL321001R8010	79.61			
					A40-30-10 230-240v 50Hz	1SBL321001R8810	79.61			
					A40-30-10 24V 50/60Hz	1SBL321001R8110	79.61			
A40-30-10 400-415V 50Hz	1SBL321001R8610	79.61								
-	-	80	-	-	A45-22-00 230-240v 50Hz	1SBL331501R8800	120.55			
					A45-40-00 220-230V 50Hz	1SBL331201R8000	120.55			
					A45-40-00 230-240v 50Hz	1SBL331201R8800	120.55			



Full range of product and technical information place this part number in a search engine and download
1SBC100122C0202

Block Contactors

A50 ... A145 ac operated



1

AC-3 400V kW	AC-3 400V A	AC-1 40°C A	Aux NO	Aux NC	Description	Product Hierarchy 1700003	
						Order Code	Price £
22	50	100	1	1	A50-30-11 110V 50/60Hz	1SBL351001R8411	101.78
					A50-30-11 220-230V 50Hz	1SBL351001R8011	101.78
					A50-30-11 230-240v 50Hz	1SBL351001R8811	101.78
					A50-30-11 24V 50/60Hz	1SBL351001R8111	101.78
					A50-30-11 400-415V 50Hz	1SBL351001R8611	101.78
			-	-	A50-40-00 110V 50/60Hz	1SBL351201R8400	149.99
			A50-40-00 220-230V 50Hz	1SBL351201R8000	149.99		
A50-40-00 230-240v 50Hz	1SBL351201R8800	149.99					

37	65	115	1	1	A63-30-11 110V 50/60Hz	1SBL371001R8411	137.37
					A63-30-11 220-230V 50Hz	1SBL371001R8011	137.37
					A63-30-11 230-240v 50Hz	1SBL371001R8811	137.37
					A63-30-11 24V 50/60Hz	1SBL371001R8111	137.37
					A63-30-11 400-415V 50Hz	1SBL371001R8611	137.37

40	75	125	1	1	A75-30-11 110V 50/60Hz	1SBL411001R8411	161.11
					A75-30-11 220-230V 50Hz	1SBL411001R8011	161.11
					A75-30-11 230-240v 50Hz	1SBL411001R8811	161.11
					A75-30-11 24V 50/60Hz	1SBL411001R8111	161.11
					A75-30-11 400-415V 50Hz	1SBL411001R8611	161.11
			-	-	A75-40-00 110V 50/60Hz	1SBL411201R8400	216.43
			A75-40-00 220-230V 50Hz	1SBL411201R8000	216.43		
A75-40-00 230-240v 50Hz	1SBL411201R8800	216.43					
A75-22-00 230-240v 50Hz	1SBL411501R8800	185.50					

45	96	145	1	1	A95-30-11 110V 50Hz	1SFL431001R8411	172.98
					A95-30-11 220-230V 50Hz	1SFL431001R8011	172.98
					A95-30-11 230-240V 50Hz	1SFL431001R8811	172.98
					A95-30-11 24V 50Hz	1SFL431001R8111	172.98
					A95-30-11 400-415V 50Hz	1SFL431001R8611	172.98

AC-3 400V kW	AC-3 400V A	AC-1 40°C A	Aux NO	Aux NC	Description	Product Hierarchy 1700001	
						Order Code	Price £
55	110	160	1	1	A110-30-11 110V 50/60Hz	1SFL451001R8411	225.21
					A110-30-11 220-230V 50Hz	1SFL451001R8011	225.21
					A110-30-11 230-240V 50Hz	1SFL451001R8811	225.21
					A110-30-11 400-415V 50Hz	1SFL451001R8611	225.21

75	145	250	1	1	A145-30-11 110V 50Hz	1SFL471001R8411	274.68
					A145-30-11 220-230V 50Hz	1SFL471001R8011	274.68
					A145-30-11 230-240V 50Hz	1SFL471001R8811	274.68
					A145-30-11 24V 50Hz	1SFL471001R8111	274.68
					A145-30-11 400-415V 50Hz	1SFL471001R8611	274.68



Full range of product and technical information place this part number in a search engine and download
1SBC100122C0202

Block Contactors

A195 ... A300 ac operated
AF50 ... AF750 ac/dc operated



A 145-30-11

SB8026C2



A 300-30-11



AF 460-30-11

SB8173C3



AF 750-30-11

SB8171C3



Full range of product and technical information place this part number in a search engine and download
1SBC100122C0202

						Product Hierarchy 1700003	
AC-3 400V kW	AC-3 400V A	AC-1 40°C A	Aux NO	Aux NC	Description	Order Code	Price £
90	185	275	1	1	A185-30-11 110V 50Hz	1SFL491001R8411	371.44
					A185-30-11 220-230V 50Hz	1SFL491001R8011	371.44
					A185-30-11 230-240V 50Hz	1SFL491001R8811	371.44
					A185-30-11 24V 50Hz	1SFL491001R8111	371.44
					A185-30-11 400-415V 50Hz	1SFL491001R8611	371.44
110	210	350	1	1	A210-30-11 110V 50Hz	1SFL511001R8411	415.22
					A210-30-11 220-230V 50Hz	1SFL511001R8011	415.22
					A210-30-11 230-240V 50Hz	1SFL511001R8811	415.22
140	260	400	1	1	A260-30-11 110V 50Hz	1SFL531001R8411	602.74
					A260-30-11 230-240V 50Hz	1SFL531001R8811	602.74
					A260-30-11 400-415V 50Hz	1SFL531001R8611	602.74
160	305	500	1	1	A300-30-11 110V 50Hz	1SFL551001R8411	732.40
					A300-30-11 230-240V 50Hz	1SFL551001R8811	732.40
22	52	100	1	1	AF50-30-11 100-250V AC/DC	1SFL477001R7011	326.76
40	75	125	1	1	AF75-30-11 100-250V AC/DC	1SBL417001R7211	205.81

						Product Hierarchy 1700001	
AC-3 400V kW	AC-3 400V A	AC-1 40°C A	Aux NO	Aux NC	Description	Order Code	Price £
75	145	250	1	1	AF145-30-11 100-250V AC/DC	1SFL477001R7011	326.76
55	110	160	1	1	AF210-30-11 100-250V AC/DC	1SFL517001R7011	444.18
160	305	500	1	1	AF300-30-11 100-250V AC/DC	1SFL557001R7011	787.19
200	400	600	1	1	AF400-30-11 100-250V AC/DC	1SFL577001R7011	876.85
250	460	700	1	1	AF460-30-11 100-250V AC/DC	1SFL597001R7011	1039.28
315	580	800	1	1	AF580-30-11 100-250V AC/DC	1SFL617001R7011	1543.37
400	750	1050	1	1	AF750-30-11 100-250V AC/DC	1SFL637001R7011	2407.41

AL9 ... AL40 - AF50 ... AF260 contactors

dc operated

1



AL 9-40-00



AL 9-22-00



AF 75-40-00



Full range of product and technical information place this part number in a search engine and download

1SBC100122C0202

AC-3 400V kW	AC-3 400V A	AC-1 40°C A	Aux NO	Aux NC	Description	Product Hierarchy 1700003	
						Order Code	Price £
4	9	25	1	-	AL9-30-10 110V DC	1SBL143001R8610	38.55
					AL9-30-10 24V DC	1SBL143001R8110	38.55
			-	1	AL9-30-01 24V DC	1SBL143001R8101	38.55
			-	-	AL9-40-00 24V DC	1SBL143201R8100	40.72
			-	-	AL9-22-00 110V DC	1SBL143501R8600	45.88
			-	-	AL9-22-00 24V DC	1SBL143501R8100	45.88

5.5	12	27	1	-	AL12-30-10 24V DC	1SBL163001R8110	40.72
-----	----	----	---	---	-------------------	-----------------	-------

7.5	17	30	1	-	AL16-30-10 24V DC	1SBL183001R8110	53.08
					AL16-30-01 24V DC	1SBL183001R8101	53.08
			-	-	AL16-40-00 24V DC	1SBL183201R8100	54.57
			-	-	AL16-22-00 110V DC	1SBL183501R8600	56.33
			-	-	AL16-22-00 24V DC	1SBL183501R8100	56.33

11	26	45	1	-	AL26-30-10 110V DC	1SBL243001R8610	64.22
					AL26-30-10 24V DC	1SBL243001R8110	64.22
			-	-	AL26-40-00 24V DC	1SBL243201R8100	66.44

15	32	55	1	-	AL30-30-10 110V DC	1SBL283001R8610	83.45
					AL30-30-10 24V DC	1SBL283001R8110	83.45

18.5	37	60	1	-	AL40-30-10 110V DC	1SBL323001R8610	94.01
					AL40-30-10 24V DC	1SBL323001R8110	94.01

22	50	100	1	1	AF50-30-11 20-60V DC	1SBL357001R7211	144.34
----	----	-----	---	---	----------------------	-----------------	--------

37	65	115	1	1	AF63-30-11 20-60V DC	1SBL377001R7211	178.89
----	----	-----	---	---	----------------------	-----------------	--------

AC-3 400V kW	AC-3 400V A	AC-1 40°C A	Aux NO	Aux NC	Description	Product Hierarchy 1700003	
						Order Code	Price £
55	110	160	1	1	AF110-30-11 20-60V DC	1SFL457001R7211	277.29

75	145	250	1	1	AF145-30-11 20-60V DC	1SFL477001R7211	326.76
----	-----	-----	---	---	-----------------------	-----------------	--------

140	260	400	1	1	AF260-30-11 20-60V DC	1SFL537001R7211	632.04
-----	-----	-----	---	---	-----------------------	-----------------	--------

N - NL Relays

ac-dc operated



NL 22 E

AC Operated Relays	Aux NO	Aux NC	Description	Product Hierarchy 1700003	
				Order Code	Price £
	2	2	N22E 110V 50/60Hz	1SBH141001R8422	19.59
			N22E 220-230V 50Hz	1SBH141001R8022	19.59
			N22E 230-240v 50Hz	1SBH141001R8822	19.59
			N22E 24V 50/60Hz	1SBH141001R8122	19.59
			N22E 400-415V 50Hz	1SBH141001R8622	19.59
	3	1	N31E 110V 50/60Hz	1SBH141001R8431	19.59
			N31E 220-230V 50Hz	1SBH141001R8031	19.59
			N31E 230-240V 50Hz	1SBH141001R8831	19.59
	4	-	N40E 110V 50/60Hz	1SBH141001R8440	19.59
			N40E 220-230V 50Hz	1SBH141001R8040	19.59
			N40E 230-240v 50Hz	1SBH141001R8840	19.59
			N40E 24V 50/60Hz	1SBH141001R8140	19.59

DC Operated Relays

	2	2	NL22E 110V DC	1SBH143001R8622	40.20
			NL22E 24V DC	1SBH143001R8122	40.20
	3	1	NL31E 110V DC	1SBH143001R8631	40.20
			NL31E 24V DC	1SBH143001R8131	40.20
	4	-	NL40E 110V DC	1SBH143001R8640	40.20
			NL40E 24V DC	1SBH143001R8140	40.20



Full range of product and technical information place this part number in a search engine and download

1SBC100122C0202

Contactor and Relays

Main Accessories



CAL 5-11

CA 5-10



TP 40 DA



TE5S-240



VE 5-1



Full range of product and technical information place this part number in a search engine and download
1SBC100122C0202

Add on Contacts A9 - A95

Description	Product Hierarchy 1700003	
	Order Code	Price
CA5-04E Top Mount Aux Block	1SBN010040R1004	10.08
CA5-04N Top Mount Aux Block	1SBN010040R1204	10.08
CA5-10 Top Mount Aux Block	1SBN010010R1010	2.82
CA5-22E Aux. Contacts	1SBN010040R1022	10.08
CA5-22M Top Mount Aux Block	1SBN010040R1122	10.08
CA5-22N Top Mount Aux Block	1SBN010040R1222	10.08
CA5-31E Top Mount Aux Block	1SBN010040R1031	10.08
CA5-31M Top Mount Aux Block	1SBN010040R1131	10.08
CA5-40E Top Mount Aux Block	1SBN010040R1040	10.08
CA5-40N Top Mount Aux Block	1SBN010040R1240	10.08
CAL5-11B Side Mount Aux Block	1SBN010420R3311	6.40
CAL5-11 Side Mount Aux Block	1SBN010020R1011	6.40
CCL5-11 Side Mount Aux Block	1SBN011421R1008	9.24
CB5-10 Start Contact	1SBN010013R1010	10.68

Add on Contacts A110>

Description	Product Hierarchy 1700001	
	Order Code	Price
CAL18-11 Side Mount Aux Block	1SFN010720R1011	12.97
CAL18-11B Side Mount Aux Block	1SFN010720R3311	12.97

Add on Timers A9 - A95

Description	Product Hierarchy 1700003	
	Order Code	Price
TP180DA Pneumatic Timer 10-180s On Delay	1SBN020300R1001	48.54
TP180IA Pneumatic Timer 10-180s Off Delay	1SBN020301R1001	48.54
TP40DA Pneumatic Timer 0.1-40s On Delay	1SBN020300R1000	40.57
TP40IA Pneumatic Timer 0.1-40s Off Delay	1SBN020301R1000	40.57

Star Delta Timers

Description	Product Hierarchy 1700003	
	Order Code	Price
TE5S-120 Star/Delta Timer 110/120V AC	1SBN020010R1002	37.55
TE5S-24 Star/Delta Timer 24V AC/DC	1SBN020010R1001	37.53
TE5S-240 Star/Delta Timer 220/240V AC	1SBN020010R1003	37.55
TE5S-440 Star/Delta Timer 380/440V AC	1SBN020010R1004	37.55

Mechanical Interlocks & Latches A9 - A95

Description	Product Hierarchy 1700003	
	Order Code	Price
VM5-1	1SBN030100R1000	6.04
VE5-1	1SBN030110R1000	11.30
VE5-2	1SBN030210R1000	22.32
WB75A 24V latching block	FPTN372726R1001	51.06

Mechanical Interlocks A110>

Description	Product Hierarchy 1700001	
	Order Code	Price
VM300/460H	1SFN035100R1000	18.75
VM300H	1SFN034700R1000	10.72
VM750H	1SFN035700R1000	20.03

Contactors and Relays

Main Accessories



RV 5/50



RC 5-1/50



LT...-AC



LT...-AL



Full range of product and technical information place this part number in a search engine and download
1SBC100122C0202

Suppressors

Description	Product Hierarchy 1700003	
	Order Code	Price
RC5-1/133 50-133VAC	1SBN050100R1001	7.73
RC5-1/250 110-250VAC	1SBN050100R1002	7.73
RC5-1/440 250-440VAC	1SBN050100R1003	7.73
RC5-1/50 24-50VAC	1SBN050100R1000	7.73
RC5-2/133 50-133VAC	1SBN050200R1001	7.73
RC5-2/250 110-250VAC	1SBN050200R1002	7.73
RC5-2/50 24-50VAC	1SBN050200R1000	7.73
RT5/150 77-150V DC	1SBN050020R1003	16.82
RT5/32 12-32V DC	1SBN050020R1000	16.82
RV5/250 110-250V AC/DC	1SBN050010R1002	7.14
RV5/50 24-50V AC/DC	1SBN050010R1000	7.14
RA5-1 Interface Relay	1SBN060300R1000	37.97

Terminal Shrouds

Description	Product Hierarchy 1700001	
	Order Code	Price
LT185-AC	1SFN124701R1000	6.90
LT185-AL	1SFN124703R1000	9.65
LT185-AY	1SFN124704R1000	5.91
LT200/A	1SAZ401901R1001	26.63
LT200E E200DU	1SAX501904R0001	19.67
LT300-AC	1SFN125101R1000	13.80
LT300-AL	1SFN125103R1000	15.80
LT320E E320DU	1SAX601904R0001	21.86
LT460-AC	1SFN125701R1000	19.45
LT460-AL	1SFN125703R1000	51.91
LT500E E500DU	1SAX701904R0001	22.47
LT750-AC	1SFN126101R1000	17.51
LT750-AL	1SFN126103R1000	52.74
LW300 Terminal Enlargement	1SFN075107R1000	23.45
LD110 Terminal Extension (Pack 1)	1SFN074308R1000	10.43
LB6 Soldering receptacle 5-POL.	GJL1201902R0001	7.92



Contactor and Relay

Main Accessories

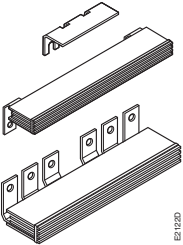

BED 185

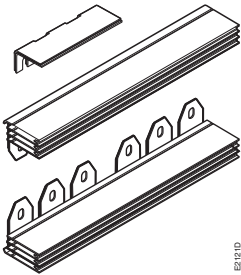

BED 400



Full range of product and technical information place this part number in a search engine and download
1SBC100122C0202

Connection Sets A9 - A95

Description	Product Hierarchy 1700003	
	Order Code	Price
BSM6-30 Reversing connecting link	GJL1201908R0001	1.78
BEY26-2 Star/Delta Starter Connection Set	1SBN082413R2000	15.97
BEY40-2 Star/Delta Main/Delta/Star Connection Set	1SBN082813R2000	17.65
BED50 Star/Delta Connection Set A30-A63	1SBN083503R1000	60.87
BED75 Star/Delta Connection Set A50-A75	1SBN084103R1000	62.72
BES75-40 Reversing Contactors A(E)45-75	1SBN083302R1000	27.33

Connection Sets A110>

Description	Product Hierarchy 1700001	
	Order Code	Price
BED95 Star/Delta Connection Set	1SFN084303R1000	61.24
BED110 Star/Delta Connection Set	1SFN084503R1000	65.00
BED145A Star/Delta Connection Set	1SFN084703R1000	83.44
BED210 Star/Delta Connection Set	1SFN085103R1000	96.85

Spare Coils A9 - A75

Description	Product Hierarchy 1700003	
	Order Code	Price
ZA16 110V 50HZ Coil	1SBN151410R8406	11.66
ZA16 230-240V 50HZ Coil	1SBN151410R8806	11.66
ZA16 400-415V 50HZ Coil	1SBN151410R8606	11.66
ZA16 A16 24V 50/60HZ Coil	1SBN151410R8106	11.66
ZA40 110V 50HZ Coil	1SBN152410R8406	16.14
ZA40 220-230V 50HZ Coil	1SBN152410R8006	16.14
ZA40 230-240V 50HZ Coil	1SBN152410R8806	16.14
ZA40 24V 50/60HZ Coil	1SBN152410R8106	16.14
ZA40 A40 400-415V 50HZ Coil	1SBN152410R8606	16.14
ZA75 110V 50HZ Coil	1SBN153510R8406	28.99
ZA75 230-240V 50HZ Coil	1SBN153510R8806	28.99
ZA75 24V 50/60HZ COIL	1SBN153510R8106	28.99
ZA75 400-415V 50HZ Coil	1SBN153510R8606	28.99

Spare Coils A110>

Description	Product Hierarchy 1700001	
	Order Code	Price
ZA110 110V 50/60HZ Coil	1SFN154310R8406	57.60

Spare Contact Sets A50 - A95

Description	Product Hierarchy 1700003	
	Order Code	Price
ZL50 Main Contact Set	1SBN163503R1000	71.57
ZL95 Main Contact Set	1SFN164303R1000	112.29

Spare Contact Sets A110>

Description	Product Hierarchy 1700001	
	Order Code	Price
ZL110 Main Contact Set	1SFN164503R1000	118.77
ZL145 Main Contact Set	1SFN164703R1000	177.52
ZL185 Main Contact Set	1SFN164903R1000	179.79
ZL210 Main Contact Set	1SFN165103R1000	214.64
ZL300 Main Contact Set	1SFN165503R1000	294.77

Block Contactors

4 Pole EK110 ... EK1000

ac operated



EK 175-40-11

1SBC573442F0301



EK 370-40-11

1SBC573432F0301



EK 1000-40-11

1SFT9099-091C2



Full range of product and technical information place this part number in a search engine and download

1SBC100122C0202

Product Hierarchy 1700002

AC-1 40°C A	Aux NO	Aux NC	Description	Order Code	Price £
200	1	1	EK110-40-11 230-240V 50Hz	SK824440-AM	306.41
250	1	1	EK150-40-11 230-240V 50Hz	SK824441-AM	373.85
300	1	1	EK175-40-11 230-240V 50Hz	SK825440-AM	524.22
350	1	1	EK210-40-11 230-240V 50Hz	SK825441-AM	649.06
550	1	1	EK370-40-11 230-240V 50Hz	SK827040-AM	1129.43
800	1	1	EK550-40-11 230-240V 50Hz	SK827041-AM	1557.44
1000	1	1	EK1000-40-11 230-240V 50Hz	SK827044-AM	1883.40

Aux Contacts

CAL16-11A Side Mount Aux Block	SK829002-A	13.36
CAL16-11B Side Mount Aux Block	SK829002-B	13.36
CAL16-11C Side Mount Aux Block	SK829002-C	13.36
CAL16-11D Side Mount Aux Block	SK829002-D	13.36

Mechanical Interlocks

VH145	SK829071-A	30.48
VH300	SK829071-B	32.08
VH800	SK829070-F	123.34

Terminal Shrouds

LT150-EK EK110 / EK150	SK178001-HB	17.79
LT210-EK EK175 / EK210	SK178001-KB	18.15

Connection Sets

BSS100 Connection Sets	SK829090-B	41.25
BSS145 Connection Sets	SK829090-F	42.36
BSS210 Connection Sets	SK829090-G	69.19
BSS550 Connection Sets	SK829090-E	123.16
BSS1000 Connection Sets	SK829090-H	186.05

Suppressors

RC-EH300/415 110-415V AC Suppressor	SK829007-B	23.37
-------------------------------------	------------	-------

Thermal & Electronic O/L Relays

A9 ... A300 - AL9 ... AL40

AF95 ... AF750 3-pole contactors



TA 25 DU

SB7386C2



TA 42 DU

SB7381C3



TA 75 DU

SB7387C2



TA 200 DU

1SFT91199-006C3



TA 450 DU



E 320 DU



Full range of product and technical information place this part number in a search engine and download

1SBC100122C0202

Thermal O/L Relays, Class 10A

For Contactors	Setting	Description	Product Hierarchy 1700006	
			Order Code	Price
A9 ... A30 AL9 ... AL40	0.10 - 0.16A	TA 25 DU 0.16	1SAZ211201R1005	24.48
	0.16 - 0.25A	TA 25 DU 0.25	1SAZ211201R1009	24.48
	0.25 - 0.4A	TA 25 DU 0.4	1SAZ211201R1013	24.48
	0.40 - 0.63A	TA 25 DU 0.63	1SAZ211201R1017	24.48
	0.63 - 1.0A	TA 25 DU 1.0	1SAZ211201R1021	24.48
	1.0 - 1.4A	TA 25 DU 1.4	1SAZ211201R1023	24.48
	1.3 - 1.8A	TA 25 DU 1.8	1SAZ211201R1025	24.48
	1.7 - 2.4A	TA 25 DU 2.4	1SAZ211201R1028	24.48
	2.2 - 3.1A	TA 25 DU 3.1	1SAZ211201R1031	24.48
	2.8 - 4.0A	TA 25 DU 4.0	1SAZ211201R1033	24.48
	3.5 - 5.0A	TA 25 DU 5.0	1SAZ211201R1035	24.48
	4.5 - 6.5A	TA 25 DU 6.5	1SAZ211201R1038	24.48
	6.0 - 8.5A	TA 25 DU 8.5	1SAZ211201R1040	24.48
	7.5 - 11A	TA 25 DU 11	1SAZ211201R1043	24.48
	10 - 14A	TA 25 DU 14	1SAZ211201R1045	25.76
	A30 ... A40 AL30 ... AL40	13 - 19A	TA 25 DU 19	1SAZ211201R1047
18 - 25A		TA 25 DU 25	1SAZ211201R1051	32.78
24 - 32A		TA 25 DU 32	1SAZ211201R1053	43.14
18 - 25A		TA 42 DU 25	1SAZ311201R1001	43.22
22 - 32A		TA 42 DU 32	1SAZ311201R1002	43.22
A50 ... A75 AL50 ... AF75	29 - 42A	TA 42 DU 42	1SAZ311201R1003	43.22
	22 - 32A	TA 75 DU 32	1SAZ321201R1002	49.21
	29 - 42A	TA 75 DU 42	1SAZ321201R1003	49.21
	36 - 52A	TA 75 DU 52	1SAZ321201R1004	58.16
	45 - 63A	TA 75 DU 63	1SAZ321201R1005	60.95
	60 - 80A	TA 75 DU 80	1SAZ321201R1006	72.55

Thermal O/L Relays, Class 10A

For Contactors	Setting	Description	Product Hierarchy 1700007	
			Order Code	Price
A95 ... A110 AF95 ... AF110	45 - 63A	TA 80 DU 63	1SAZ331201R1005	73.25
	60 - 80A	TA 80 DU 80	1SAZ331201R1006	76.25
	65 - 90A	TA 110 DU 90	1SAZ411201R1001	109.81
	80 - 110A	TA 110 DU 110	1SAZ411201R1002	121.21
A145 ... A185	80 - 110A	TA 200 DU 110	1SAZ421201R1002	142.51
	100 - 135A	TA 200 DU 135	1SAZ421201R1003	142.51
	110 - 150A	TA 200 DU 150	1SAZ421201R1004	142.51
	130 - 175A	TA 200 DU 175	1SAZ421201R1005	142.51
	150 - 200A	TA 200 DU 200	1SAZ421201R1006	142.51
A210 ... A300	130 - 185A	TA450 DU 185	1SAZ511201R1001	172.19
	165 - 235A	TA450 DU 235	1SAZ511201R1002	172.19
	220 - 310A	TA450 DU 310	1SAZ511201R1003	203.29

Thermal & Electronic O/L Relays

Electronic Overload Relays & Accessories

Electronic O/L Relays

Electronic O/L Relays			Product Hierarchy 1700006	
For Contactors	Setting	Description	Order Code	Price
A9 ... A16 AL9 ... AL16	0.3 - 0.1.0A	E16DU1.0	1SAZ211201R1005	50.39
	0.9 - 2.7A	E16DU2.7	1SAX111001R1103	50.39
	2.0 - 6.3A	E16DU6.3	1SAX111001R1104	52.80
	5.7 - 18.9A	E16DU18.9	1SAX111001R1105	52.80

Electronic O/L Relays

Electronic O/L Relays			Product Hierarchy 1700007	
For Contactors	Setting	Description	Order Code	Price
A145 ... A185	60 - 200A	E200DU200	1SAX511001R1101	247.28
A210 ... A300	100 - 320A	E320DU320	1SAX521001R1101	287.86
AF400 ... AF460	150 - 500A	E500DU500	1SAX711001R1101	368.32
AF580 ... AF750	250 - 800A	E800DU800	1SAX811001R1101	514.29

Separate Mounting Kits

Separate Mounting Kits		Product Hierarchy 1700006	
For Overload Relays	Description	Order Code	Price
TA25DU ...	DB25/25A	1SAZ201108R0001	11.92
TA25DU32 ...	DB25/32A	1SAZ201108R0002	11.92
TA42,TA75,TA80 ...	DB80	1SAZ301110R0001	18.24
E16DU	DB16E	1SAX101110R0001	15.21
E140DU	DB140E	1SAX301110R1002	46.57

Separate Mounting Kits

Separate Mounting Kits		Product Hierarchy 1700007	
For Overload Relays	Description	Order Code	Price
TA110,TA200 ...	DB200	1SAZ401110R0001	23.58
TA450DU/SU ...	DT450/A300	1SAZ501902R1001	58.55
E500DU	DT500/AF460L	1SAX701902R1001	55.74

Accessories

Accessories		Product Hierarchy 1700006	
For Overload Relays	Description	Order Code	Price
24v Remote Reset T25DU	DR25-A-24	1SAZ201504R0001	25.13
110v Remote Reset T25DU	DR25-A-110	1SAZ201504R0003	25.13
220/380v Remote Reset T25DU	DR25-A-220/380	1SAZ201504R0005	25.13



Full range of product and technical information place this part number in a search engine and download

1SBC100122C0202

Mini Contactors

3 - 4 Pole Contactors and Relays

1



B6-30-10



B6-30-10F



B6-30-10P



B7-30-10



B7-40-10



Full range of product and technical information place this part number in a search engine and download
1SBC100122C0202

AC3 @415v	Aux Contacts		Description	Product Hierarchy 1700004	
	NO	NC		Order Code	Price

3 pole contactors

8.5	-	1	B6-30-01 230AC	GJL1211001R8010	14.20
			B6-30-01 24AC	GJL1211001R0011	14.20
			B6-30-01-F 110AC •	GJL1211003R8014	14.20
			B6-30-01-F 24AC •	GJL1211003R0011	14.20
	1	-	B6-30-10 110AC	GJL1211001R8104	14.20
			B6-30-10 230AC	GJL1211001R8100	14.20
			B6-30-10 24AC	GJL1211001R0101	14.20
			B6-30-10 400AC	GJL1211001R8105	14.20

4 pole contactors

8.5	-	-	B6-40-00 110AC	GJL1211201R8004	14.20
			B6-40-00 230AC	GJL1211201R8000	14.20
			B6-40-00 24AC	GJL1211201R0001	14.20
			B6-40-00-F 230AC •	GJL1211203R8000	14.20

3 pole interface contactors

8.5	-	1	B7-30-01 230AC	GJL1311001R8010	23.34
			B7-30-10 110AC	GJL1311001R8104	23.34
	1	-	B7-30-10 230AC	GJL1311001R8100	23.34
			B7-30-10 24AC	GJL1311001R0101	23.34

3 pole DC contactors

8.5	-	1	BC6-30-01 110DC	GJL1213001R0014	14.20
			BC6-30-01 24DC	GJL1213001R0011	14.20
			BC6-30-01-F 24DC •	GJL1213003R0011	14.20

Reversing Pairs

-	-	1	VB6-30-01 110AC	GJL1211901R8014	36.11
			VB6-30-10 110AC	GJL1211901R8104	36.11
	1	-	VB6-30-10 230AC	GJL1211901R8100	36.11
			VB6-30-10 24AC	GJL1211901R0101	36.11
			VB6A-30-10 230AC	GJL1211911R8100	36.11
			VB6A-40-00 220-240V 40-450HZ	GJL1211911R8000	36.11

Relays

-	2	2	K6-22Z 230AC Mini Contactor Relay	GJH1211001R8220	14.20
			K6-31Z 230AC Mini Contactor Relay	GJH1211001R8310	14.20
	2	2	KC6-22Z 110DC Mini Contactor Relay	GJH1213001R0224	14.20
			KC6-22Z 24DC Mini Contactor Relay	GJH1213001R0221	14.20

• Flat Pin Terminals

Mini Contactors

Thermal Overloads and Accessories



Description	Product Hierarchy 1700006	
	Order Code	Price

Overload Relays

Description	Order Code	Price
T7DU-0.4 Thermal Overload (0.24-0.4A)	1SAZ111301R0003	22.29
T7DU-0.6 Thermal Overload (0.4-0.6A)	1SAZ111301R0004	22.29
T7DU-1.0 Thermal Overload (0.6-1.0A)	1SAZ111301R0005	22.29
T7DU-1.6 Thermal Overload (1.0-1.6A)	1SAZ111301R0006	22.29
T7DU-2.4 Thermal Overload (1.6-2.4A)	1SAZ111301R0007	22.29
T7DU-4.0 Thermal Overload (2.4-4.0A)	1SAZ111301R0008	22.29
T7DU-6.0 Thermal Overload (4.0-6.0A)	1SAZ111301R0009	22.29
T7DU-9.0 Thermal Overload (6.0-9.0A)	1SAZ111301R0010	22.29
T7DU-12.0 Thermal Overload (9.0-12A)	1SAZ111301R0011	22.29

Accessories	Product Hierarchy 1700003	
	Order Code	Price
DB16E Mounting Kit E16DU	1SAX101110R0001	15.21
LB6 Soldering receptacle 5-POL.	GJL1201902R0001	7.92
BA5.50 pkt 50 markers for a range cont	1SBN110000R1000	21.53
BSM6-30 Reversing connecting link	GJL1201908R0001	1.78
RV-BC6/60 Varistor	GHV2501902R0002	2.67



Full range of product and technical information place this part number in a search engine and download
1SBC100122C0202

Manual Motor Starters

MS116 ... M495



MS 116

SST11601

1



Manual Motor Starter MS116

	Product Hierarchy 1800002	
	Order Code	Price
MS 116 - 0.25	1SAM250000R1002	30.41
MS 116 - 0.4	1SAM250000R1003	30.63
MS 116 - 0.63	1SAM250000R1004	30.63
MS 116 - 1.0	1SAM250000R1005	32.71
MS 116 - 1.6	1SAM250000R1006	34.65
MS 116 - 2.5	1SAM250000R1007	36.54
MS 116 - 4	1SAM250000R1008	36.54
MS 116 - 6.3	1SAM250000R1009	36.54
MS 116 - 10.0	1SAM250000R1010	40.50
MS 116 - 12..0	1SAM250000R1012	40.50
MS 116 - 16.0	1SAM250000R1011	40.50

Manual Motor Starters MS132

Description	Product Hierarchy 1800001	
	Order Code	Price
MS 132 - 0.16	1SAM350000R1001	36.37
MS 132 - 0.25	1SAM350000R1002	36.37
MS 132 - 0.4	1SAM350000R1003	36.37
MS 132 - 0.63	1SAM350000R1004	36.37
MS 132 - 1.0	1SAM350000R1005	41.84
MS 132 - 1.6	1SAM350000R1006	41.84
MS 132 - 2.5	1SAM350000R1007	41.84
MS 132 - 4.0	1SAM350000R1008	41.84
MS 132 - 6.3	1SAM350000R1009	41.84
MS 132 - 10	1SAM350000R1010	45.98
MS 132 - 12	1SAM350000R1012	49.40
MS 132 - 16	1SAM350000R1011	49.40
MS 132 - 20	1SAM350000R1013	52.14
MS 132 - 25	1SAM350000R1014	59.01
MS 132 - 32	1SAM350000R1015	74.78

Manual Motor Starter MS450 - 495

	Product Hierarchy 1800001	
	Order Code	Price
MS 450 - 40	1SAM450000R1005	140.51
MS 450 - 50	1SAM450000R1007	157.92
MS 495 - 63	1SAM550000R1007	168.36
MS 495 - 75	1SAM550000R1008	177.09
MS 495 - 100	1SAM550000R1010	209.00



Full range of product and technical information place this part number in a search engine and download
1SBC100122C0202



Full range of product and technical information place this part number in a search engine and download
1SBC100155C0201

Manual Motor Starters

Accessories



Accessories

	Product Hierarchy 1800002	
	Order Code	Price
HK4-11 Side Mount Aux Block	1SAM401901R1001	9.79
AA1-24 Shunt Trip 24V	1SAM201910R1001	31.40
AA1-110 Shunt Trip 100V	1SAM201910R1002	31.40
BEA40/450 Connection Module	1SBN083206R1000	8.55

Accessories MS116 ... MS132

	Product Hierarchy 1800002	
	Order Code	Price
HKF1-11 Front	1SAM201901R1001	6.10
HK1-11 Side	1SAM201902R1001	6.10
HK1-20 Side	1SAM201902R1002	6.10
SK1-11 Signal	1SAM201903R1001	9.63
BEA7/116 Connection Module	1SBN080906R1000	3.61
BEA16/116 Connection Module	1SBN081406R1000	3.61
OHB2AJM Black Handle	OHB2AJM	6.79

MS116	MS132	No. MMS	Aux Contacts	Part no	Product Hierarchy 1800002	
					Order Code	Price
3-phase busbar up to 65A						
•	•	2	0	PS1-2-0-65	1SAM201906R1102	5.92
•	•	3	0	PS1-3-0-65	1SAM201906R1103	7.01
•	•	4	0	PS1-4-0-65	1SAM201906R1104	8.18
•	•	5	0	PS1-5-0-65	1SAM201906R1105	8.94
•	•	2	1	PS1-2-1-65	1SAM201906R1112	6.18
•	•	3	1	PS1-3-1-65	1SAM201906R1113	7.31
•	•	4	1	PS1-4-1-65	1SAM201906R1114	8.29
•	•	5	1	PS1-5-1-65	1SAM201906R1115	9.31
•	•	2	2	PS1-2-2-65	1SAM201906R1122	7.09
•	•	3	2	PS1-3-2-65	1SAM201906R1123	7.93
•	•	4	2	PS1-4-2-65	1SAM201906R1124	8.81
•	•	5	2	PS1-5-2-65	1SAM201906R1125	9.99

3-phase feeder terminals

65A	Remarks	mm ²	Part no	Product Hierarchy 1800002	
				Order Code	Price
•	flat	25mm ²	S1-M1-25	1SAM201907R1101	6.20
•	high		S1-M2-25	1SAM201 907R1102	7.41



Full range of product and technical information place this part number in a search engine and download

ISBN 1001220202

Soft Starters

Basic PSR and Advanced PSS/PST



PSR3 ... PSR16

PSR Basic Softstarts

Description	Part No	Product Hierarchy 1600002	
		Order Code	Price
Basic Softstarter 3A	PSR3-600-70	1SFA896103R7000	88.22
Basic Softstarter 6A	PSR6-600-70	1SFA896104R7000	98.56
Basic Softstarter 9A	PSR9-600-70	1SFA896105R7000	116.02
Basic Softstarter 12A	PSR12-600-70	1SFA896106R7000	125.60
Basic Softstarter 16A	PSR16-600-70	1SFA896107R7000	144.78
Basic Softstarter 25A	PSR25-600-70	1SFA896108R7000	163.97
Basic Softstarter 30A	PSR30-600-70	1SFA896109R7000	193.65
Basic Softstarter 37A	PSR37-600-70	1SFA896110R7000	247.74
Basic Softstarter 45A	PSR45-600-70	1SFA896111R7000	318.37
Basic Softstarter 60A	PSR60-600-70	1SFA896112R7000	364.50
Basic Softstarter 72A	PSR72-600-70	1SFA896113R7000	439.11
Basic Softstarter 85A	PSR85-600-70	1SFA896114R7000	481.71
Basic Softstarter 105A	PSR105-600-70	1SFA896115R7000	530.86
Connection Kit PSR3 - 16 and MS116		1SFA896211R1001	5.80
Connection Kit PSR37 - 45 and MS450		1SFA896213R1001	14.68
Connection Kit PSR60 - 105 and MS495		1SAM501903R1001	13.57
Fan for PSR3 to PSR45		1SFA896311R1001	34.26
Fan for PSR60 to PSR105		1SFA896313R1001	37.48

PST Advanced Softstarts

Description	Part No	Product Hierarchy 1600001	
		Order Code	Price
Advanced Softstarter 30A	PST30-600-70	1SFA894002R7000	903.29
Advanced Softstarter 37A	PST37-600-70	1SFA894003R7000	984.71
Advanced Softstarter 44A	PST44-600-70	1SFA894004R7000	1038.53
Advanced Softstarter 50A	PST50-600-70	1SFA894005R7000	1071.36
Advanced Softstarter 60A	PST60-600-70	1SFA894006R7000	1159.33
Advanced Softstarter 72A	PST72-600-70	1SFA894007R7000	1330.01
Advanced Softstarter 85A	PST85-600-70	1SFA894008R7000	1441.61
Advanced Softstarter 105A	PST105-600-70	1SFA894009R7000	1576.84
Advanced Softstarter 142A	PST142-600-70	1SFA894010R7000	1819.74
Advanced Softstarter 175A	PST175-600-70	1SFA894011R7000	2049.49
Advanced Softstarter 210A	PST210-600-70	1SFA894012R7000	2239.88
Advanced Softstarter 250A	PST250-600-70	1SFA894013R7000	2456.50
Advanced Softstarter 300A	PST300-600-70	1SFA894014R7000	2526.09
External Keypad kit for PST range	PSTEK	1SFA899003R1000	248.52



PST30...PST72



Full range of product and technical information place this part number in a search engine and download

1SFC132004C0201

Pilot Devices - Compact 22mm

Push Buttons, Selector Switches, Pilot Lights



22mm Pushbuttons

	Product Hierarchy 1300001	
	Order Code	Price
Green 1NO	1SFA619100R1012	4.99
Yellow 1NO	1SFA619100R1013	4.99
Blue 1NO	1SFA619100R1014	4.99
Black 1NO	1SFA619100R1016	4.99
Green 2NO	1SFA619100R1022	7.06
Black 2NO	1SFA619100R1026	7.06
Red 1NC	1SFA619100R1041	4.99
Black 1NC	1SFA619100R1046	4.99
Red 1NO/1NC	1SFA619100R1071	7.06
Green 1NO/1NC	1SFA619100R1072	7.06
Yellow 1NO/1NC	1SFA619100R1073	7.06
Blue 1NO/1NC	1SFA619100R1074	7.06
Extended Red 1NC	1SFA619102R1041	4.99

22mm Selector Switches 2 Position

Black Stay Put Switch Position BC 1NO	1SFA619200R1016	7.05
Black Stay Put Switch Position BC 2NO	1SFA619200R1026	9.11
Black Stay Put Switch Position BC 1NO/1NC	1SFA619200R1076	9.11
Black Stay Put Switch Position AC 1NO	1SFA619201R1016	7.05
Black Stay Put Switch Position AC 2NO	1SFA619201R1026	9.11
Black Stay Put Switch Position AC 1NC	1SFA619201R1046	7.05
Black Stay Put Switch Position AC 1NO/1NC	1SFA619201R1076	9.11
Black Spring Return Switch Position BC 2NO	1SFA619202R1026	9.11
Black Spring Return Switch Position BC 2NO 1NO/1NC	1SFA619202R1076	9.11

22mm Selector Switches 3 Position

Black Stay Put Switch Position ABC 2NO	1SFA619210R1026	9.11
Black Stay Put Switch Position ABC 1NO/1NC	1SFA619210R1076	9.11
Black Spring Return Switch Position A-B-C 2NO	1SFA619211R1026	9.11
Black Spring Return Switch Position AB-C 2NO	1SFA619212R1026	9.11
Black Spring Return Switch Position AB-C 1NO/1NC	1SFA619212R1076	9.11

22mm Pilot Light Heads

Red	1SFA619402R1001	3.77
Green	1SFA619402R1002	3.77
Yellow	1SFA619402R1003	3.77
Blue	1SFA619402R1004	3.77
White	1SFA619402R1005	3.77
Clear	1SFA619402R1008	3.77

Pilot Devices - Modular 22mm

Push Buttons, Selector Switches



Full range of product and technical information place this part number in a search engine and download

1SFC151003C0201

22mm Pushbuttons

Black Plastic Bezel

	Order Code	Price
Red Non Illuminated Momentary Flush	1SFA611100R1001	3.18
Green Non Illuminated Momentary Flush	1SFA611100R1002	3.18
Yellow Non Illuminated Momentary Flush	1SFA611100R1003	3.18
Blue Non Illuminated Momentary Flush	1SFA611100R1004	3.18
White Non Illuminated Momentary Flush	1SFA611100R1005	3.18
Black Non Illuminated Momentary Flush	1SFA611100R1006	3.18
Red Illuminated Momentary Flush	1SFA611100R1101	3.18
Green Illuminated Momentary Flush	1SFA611100R1102	3.18
Yellow Illuminated Momentary Flush	1SFA611100R1103	3.18
White Illuminated Momentary Flush	1SFA611100R1105	3.18

Chrome Plastic Bezel

Red Non Illuminated Momentary Flush	1SFA611100R2001	3.18
Green Non Illuminated Momentary Flush	1SFA611100R2002	3.18
Yellow Non Illuminated Momentary Flush	1SFA611100R2003	3.18
Blue Non Illuminated Momentary Flush	1SFA611100R2004	3.18
White Non Illuminated Momentary Flush	1SFA611100R2005	3.18
Black Non Illuminated Momentary Flush	1SFA611100R2006	3.18

Metal Bezel

Red Non Illuminated Momentary Flush	1SFA611100R3001	4.20
Green Non Illuminated Momentary Flush	1SFA611100R3002	4.20
Black Non Illuminated Momentary Flush	1SFA611100R3006	4.20
Red Illuminated Momentary Flush	1SFA611100R3101	4.20
Blue Illuminated Momentary Flush	1SFA611100R3104	4.20
Red Non Illuminated Momentary Extended	1SFA611102R1001	3.18
Red Non Illuminated 40mm Mushroom	1SFA611124R1001	9.77
Red Non Illuminated 60mm Mushroom	1SFA611125R1001	10.30
Green/Red Non Illuminated Double Pushbutton	1SFA611130R1106	8.01
Green/Red Illuminated Double Pushbutton	1SFA611131R1102	10.82
Green/Red Non Illuminated Double Pushbutton	1SFA611131R1106	10.82
Green/Red Non Illuminated Double Pushbutton Ext Lower	1SFA611144R1106	10.82
Green/Red Illuminated Double Pushbutton	1SFA611144R1108	10.82

22mm Selector Switches

Black Plastic Bezel

Black Non Illuminated 2 Pos Selector Short Handle	1SFA611200R1006	5.74
Black Non Illuminated 2 Pos Selector Short Handle	1SFA611201R1006	5.74
Black Non Illuminated 3 Pos Selector Short Handle	1SFA611210R1006	5.74
Black Non Illuminated 3 Pos Selector Short Handle	1SFA611211R1006	5.74
Black Non Illuminated 3 Pos Selector Long Handle	1SFA611213R1006	5.74

Chrome Plastic Bezel

Black Non Illuminated 2 Pos Selector Short Handle	1SFA611200R2006	5.74
Black Non Illuminated 2 Pos Selector Short Handle	1SFA611201R2006	5.74
Black Non Illuminated 2 Pos Selector Short Handle	1SFA611201R2006	5.74
Black Non Illuminated 3 Pos Selector Short Handle	1SFA611211R2006	5.74
Black Non Illuminated 3 Pos Selector Short Handle	1SFA611212R2006	5.74

Metal Bezel

Black Non Illuminated 3 Pos Selector Short Handle	1SFA611201R3006	6.52
---	-----------------	------

Pilot Devices - Modular 22mm

Key Switches, Pilot Lights, Contact Blocks

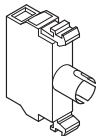
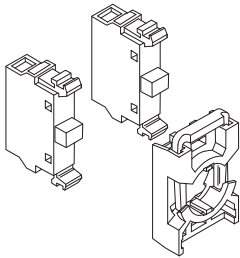

Full range of product and technical information place this part number in a search engine and download
1SFC151003C0201

Product Hierarchy 1300002

22mm Key Switches

	Order Code	Price
2 Pos Key Selector Key Remove Both	1SFA611280R1001	15.75
2 Pos Key Selector Key Remove B Only	1SFA611281R1001	15.75
2 Pos Key Selector Key Remove B Only (momentary)	1SFA611282R1001	15.75
3 Pos Key Selector Key Remove All	1SFA611283R1001	15.75
3 Pos Key Selector Key Remove B Only	1SFA611284R1001	15.75
3 Pos Key Selector Key Remove B Only (momentary)	1SFA611285R1001	15.75

Pilot Light Heads

Red	1SFA611400R1001	1.81
Green	1SFA611400R1002	1.81
Yellow	1SFA611400R1003	1.81
Blue	1SFA611400R1004	1.81
White	1SFA611400R1005	1.81
Clear	1SFA611400R1008	1.81

Emergency Stops

Red Non Illuminated E-Stop 40mm	1SFA611510R1001	9.29
Red Non Illuminated E-Stop 60mm	1SFA611513R1001	10.21

Contact Blocks

5 Block Holder	1SFA611601R1100	1.78
3 Block Holder	1SFA611605R1100	0.49
3 Block Holder + 1NO	1SFA611605R1101	3.05
3 Block Holder + 2NO	1SFA611605R1102	5.62
3 Block Holder + 1NC	1SFA611605R1110	3.05
3 Block Holder + 1NO & 1NC	1SFA611605R1111	5.62
3 Block Holder + 2NC	1SFA611605R1120	5.62
3 Block Holder + MLB-1	1SFA611605R1200	3.02
3 Block Holder + 1NO & 1LB	1SFA611605R1201	5.59
3 Block Holder + 1NO + 1NC + 1LB	1SFA611605R1211	8.16
Contact Block 1NO	1SFA611610R1001	2.58
Double Contact Block 2NO	1SFA611610R1002	5.20
Contact Block 1NC	1SFA611610R1010	2.58
Double Contact Block 1NO + 1NC	1SFA611610R1011	5.20
Double Contact Block 2NC	1SFA611610R1020	5.20
Rear Mount Contact Block - 1NO	1SFA611610R2001	2.58
Rear Mount Contact Block - 1NC	1SFA611610R2010	2.58
Rear Mount Contact Block - 1NO + 1NC	1SFA611610R2011	5.20

Lamp Blocks

Lamp Block MLB-1	1SFA611620R1001	2.53
Lamp Block MLB-2	1SFA611620R1002	5.02
Lamp Block MLB-3	1SFA611620R1003	5.02
Lamp Block MLB-4	1SFA611620R1004	5.62
Lamp Block MLB-5	1SFA611620R1005	5.62
Rear Mount Lamp Block - Full Voltage	1SFA611620R2001	2.53
Diode Block	1SFA611630R1001	4.70

Pilot Devices - Modular 22mm

Enclosures and Accessories

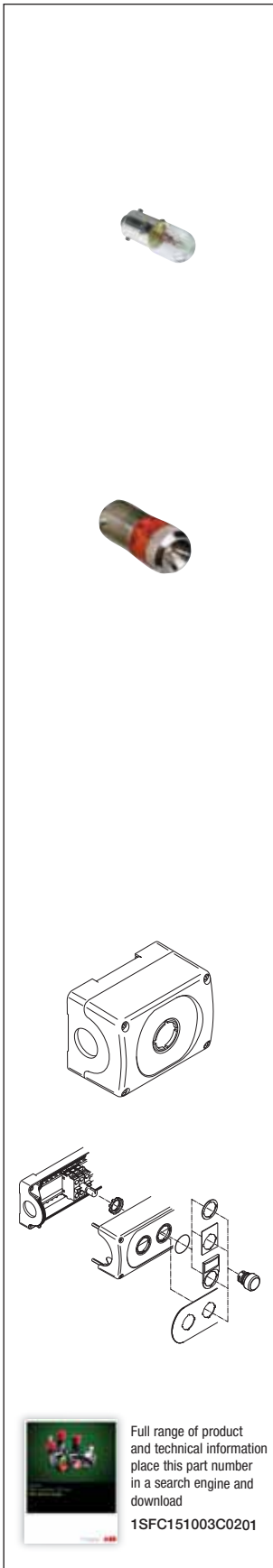

LEDs	Product Hierarchy 1300002	
	Order Code	Price
White LED 12V	1SFA616921R2015	8.39
Red LED 24V	1SFA616921R2021	8.39
Green LED 24V	1SFA616921R2022	8.39
Yellow LED 24V	1SFA616921R2023	8.39
Blue LED 24V	1SFA616921R2024	8.39
White LED 24V	1SFA616921R2025	8.39
Red LED 110-130V AC	1SFA616921R2131	8.39
Green LED 110-130V AC	1SFA616921R2132	8.39
Yellow LED 110-130V AC	1SFA616921R2133	8.39
Blue LED 110-130V AC	1SFA616921R2134	8.39
White LED 110-130V AC	1SFA616921R2135	8.39
Green LED 110-130V AC	1SFA616921R2142	8.39
White LED 110-130V AC/DC	1SFA616921R2145	8.39
Red LED 230V	1SFA616921R2221	8.39
Green LED 230V	1SFA616921R2222	8.39
Yellow LED 230V	1SFA616921R2223	8.39
Blue LED 230V	1SFA616921R2224	8.39
White LED 230V	1SFA616921R2225	8.39
Filament		
6v Filament Bulb	5911086-11	0.76
12v Filament Bulb	5911086-12	0.76
24v Filament Bulb	5911086-13	0.74
60v Filament Bulb	5911086-14	1.13
130v Filament Bulb	5911086-15	1.74
30v Filament Bulb	5911086-4	0.83
110v Filament Bulb	5911086-7	1.74

Enclosures & Accessories	Product Hierarchy 1300002	
	Order Code	Price
Empty Grey Enclosure - 1 Seat	1SFA611811R1000	8.87
Empty Grey Enclosure - 2 Seat	1SFA611812R1000	10.44
Empty Grey Enclosure - 3 Seat	1SFA611813R1000	13.09
Empty Grey Enclosure - 4 Seat	1SFA611814R1000	18.34
Empty Yellow Enclosure - 1 Seat	1SFA611821R1000	6.64
Mounting Tool (New Modular)	1SFA611920R8015	4.28
Emergency Stop Shroud - Modular	1SFA611920R8053	5.56
Blanking Plug (Black)	1SFA611920R8130	1.94
Legend Plate Holder - Black	1SFA616920R8120	0.91
Legend Plate Insert - Blank	1SFA616920R8121	0.30

Electronic Products and Relays

Timer Relays

2CDC 251 089 F0b06



CT-MFD.12

2CDC 251 049 F0b07



CT-MVS.21

1SVR 550 029 F8 100



T-MFE



Full range of product and technical information place this part number in a search engine and download
2CDC110004C0206

Timer Relays	Product Hierarchy 400006	
	Order Code	Price
Description		
CT-AHE Time relay, OFF-delay , 1c/o, 3-300s, 24VAC/DC	1SVR550118R2100	33.39
CT-ARE Time relay, true OFF-delay , 1c/o, 0.1-10s, 24VAC/DC, 220-240VAC	1SVR550127R1100	36.68
CT-ARE Time relay, true OFF-delay , 1c/o, 0.3-30s, 24VAC/DC, 220-240VAC	1SVR550127R4100	36.68
CT-VWE Time relay, impulse-ON , 1c/o, 0.1-10s, 24VAC/DC 220-240VAC	1SVR550137R1100	23.58
CT-YDE Time relay, star-delta , 1c/o, 0.3-30s, 24VAC/DC 220-240VAC	1SVR550207R4100	23.58
CT-SDE Time relay, star-delta , 1c/o, 0.3-30s, 380-415VAC	1SVR550212R4100	22.06
CT-SDE Time relay, star-delta , 1c/o, 0.3-30s, 24VAC/DC 220-240VAC	1SVR550217R4100	22.06
CT-MFS.21 Time relay, multifunction , 2c/o, 24-240VAC/DC	1SVR630010R0200	73.54
CT-MBS.22 Time relay, multifunction , 2c/o, 24-48VDC, 24-240VAC	1SVR630010R3200	64.01
CT-MVS.21 Time relay, multifunction , 2c/o, 24-240VAC/DC	1SVR630020R0200	73.54
CT-MVS.12 Time relay, multifunction , 1c/o, 24-48VDC, 24-240VAC	1SVR630020R3100	57.20
CT-MVS.22 Time relay, multifunction , 2c/o, 24-48VDC, 24-240VAC	1SVR630020R3300	64.01
CT-MVS.23 Time relay, multifunction , 2c/o, 380-440VAC	1SVR630021R2300	70.81
CT-MXS.22 Time relay, multifunction , 2c/o, 24-48VDC, 24-240VAC	1SVR630030R3300	73.54
CT-WBS.22 Time relay, impulse & flasher , 2c/o, 24-48VDC, 24-240VAC	1SVR630040R3300	47.33
CT-ERS.21 Time relay, ON-delay , 2c/o, 24-240VAC/DC	1SVR630100R0300	52.11
CT-ERS.12 Time relay, ON-delay , 1c/o, 24-48VDC, 24-240VAC	1SVR630100R3100	38.48
CT-ERS.22 Time relay, ON-delay , 2c/o, 24-48VDC, 24-240VAC	1SVR630100R3300	45.29
CT-AHS.22 Time relay, OFF-delay , 2c/o, 24-48VDC, 24-240VAC	1SVR630110R3300	52.11
CT-ARS.11 Time relay, true OFF-delay , 1c/o, 24-240VAC/DC	1SVR630120R3100	64.01
CT-ARS.21 Time relay, true OFF-delay , 2c/o, 24-240VAC/DC	1SVR630120R3300	74.90
CT-APS.21 Time relay, OFF-delay , 2c/o, 24-240VAC/DC	1SVR630180R0300	58.90
CT-APS.12 Time relay, OFF-delay , 1c/o, 24-48VDC, 24-240VAC	1SVR630180R3100	46.66
CT-SDS.22 Time relay, star-delta , 2n/o, 24-48VDC, 24-240VAC	1SVR630210R3300	43.92
CT-SDS.23 Time relay, star-delta , 2n/o, 380-440VAC	1SVR630211R2300	50.74
CT-MFD.12 Time relay, multifunction , 1c/o, 24-240VAC 24-48VDC	1SVR500020R0000	45.86
CT-MFD.21 Time relay, multifunction , 2c/o, 12-240VAC/DC	1SVR500020R1100	85.55
CT-ERD.12 Time relay, ON-delay , 1c/o, 24-240VAC 24-48VDC	1SVR500100R0000	34.70
CT-AHD.12 Time relay, OFF-delay , 1c/o, 24-240VAC 24-48VDC	1SVR500110R0000	38.00
CT-VWD.12 Time relay, impulse-ON , 1c/o, 24-240VAC 24-48VDC	1SVR500130R0000	34.70
CT-EBD.12 Time relay, flasher , 1c/o, 24-240VAC 24-48VDC	1SVR500150R0000	34.70
CT-TGD.12 Time relay, pulse generator , 1c/o, 24-240VAC 24-48VDC	1SVR500160R0000	43.23
CT-SAD.22 Time relay, star-delta , 2n/o, 24-48VDC, 24-240VAC	1SVR500210R0100	58.42
CT-MKE Time relay, solid-state, multif. , 1n/o, 0.1-10s/3-300s, 24-240VAC/DC	1SVR550019R0000	32.09
CT-MFE Time relay, multifunction , 1c/o, 0.05s-100h, 24-240VAC/DC	1SVR550029R8100	36.68
CT-ERE Time relay, ON-delay , 1c/o, 0.1-10s, 24VAC/DC 220-240VAC	1SVR550107R1100	23.58
CT-ERE Time relay, ON-delay , 1c/o, 3-300s, 24VAC/DC 220-240VAC	1SVR550107R2100	23.58
CT-ERE Time relay, ON-delay , 1c/o, 0.3-30s, 24VAC/DC 220-240VAC	1SVR550107R4100	23.58
CT-ERE Time relay, ON-delay , 1c/o, 0.3-30min, 24VAC/DC 220-240VAC	1SVR550107R5100	23.58
CT-AHE Time relay, OFF-delay , 1c/o, 3-300s, 220-240VAC	1SVR550111R2100	33.39

Electronic Products and Relays

Measuring & Monitoring Relays

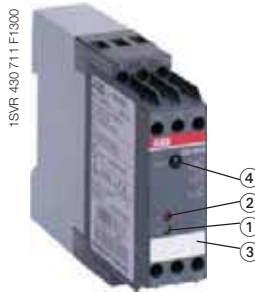

CM-MSS (3)

- ① F: red LED - fault tripping
- ② U: green LED - control supply voltage
- ③ Marker label
- ④ Reset button



CM-SRS.2

- ① Threshold value adjustment
- ② Hysteresis adjustment
- ③ DIP switches (see DIP switch functions)
- ④ U/T: green LED - control supply voltage, (timing)
- ⑤ R: yellow LED - relay status
- ⑥ I: red LED - over- / undercurrent
- ⑦ Adjustment of the tripping delay T_V



Full range of product and technical information place this part number in a search engine and download
2CDC110004C0206

Measuring & Monitoring Relays		Product Hierarchy 400004	
Description	Order Code	Price	
CM-MSS Thermistor motor protection relay , 2x1c/o, 24-240VAC/DC	1SVR430710R0200	98.76	
CM-MSS Thermistor motor protection relay , 2c/o, 24VAC/DC	1SVR430710R9300	45.33	
CM-MSS Thermistor motor protection relay , 2c/o, 110-130VAC	1SVR430711R0300	45.33	
CM-MSS Thermistor motor protection relay , 2c/o, 380-415VAC	1SVR430711R2300	51.87	
CM-MSS Thermistor motor protection relay , 2c/o, 24-240VAC/DC	1SVR430720R0300	80.19	
CM-MSS Thermistor motor protection relay , 1n/o+1n/c, 24-240VAC/DC	1SVR430720R0400	75.72	
CM-EFS.2 Voltage window monitoring relay , 2c/o, B-C=3-600VRMS, 24-240VAC/DC	1SVR430750R0400	140.46	
CM-MSS Thermistor motor protection relay , 1c/o, 24VAC/DC	1SVR430800R9100	39.56	
CM-MSS Thermistor motor protection relay , 1c/o, 220-240VAC	1SVR430801R1100	39.56	
CM-MSS Thermistor motor protection relay , 2c/o, 24VAC/DC	1SVR430810R9300	42.83	
CM-MSS Thermistor motor protection relay , 2c/o, 110-130VAC	1SVR430811R0300	42.83	
CM-MSS Thermistor motor protection relay , 2c/o, 220-240VAC	1SVR430811R1300	42.83	
CM-MSS Thermistor motor protection relay , 2c/o, 24VAC	1SVR430811R9300	42.83	
CM-PFS Three-phase monitoring relay , 2c/o, L1-L2-L3=200-500VAC 50/60Hz	1SVR430824R9300	56.85	
CM-ESS.1 Voltage monitoring relay , 1c/o, B-C=3-600VRMS, 24-240VAC/DC	1SVR430830R0300	118.98	
CM-ESS.2 Voltage monitoring relay , 2c/o, B-C=3-600VRMS, 24-240VAC/DC	1SVR430830R0400	129.71	
CM-ESS.M Voltage monitoring relay , 2c/o, B-C=3-600VRMS, 24-240VAC/DC	1SVR430830R0500	140.46	
CM-ESS.1 Voltage monitoring relay , 1c/o, B-C=3-600VRMS, 220-240VAC	1SVR430831R1300	99.96	
CM-SRS.21 Current monitoring relay , 2c/o, B-C=3mA-1A RMS, 24-240VAC/DC	1SVR430840R0400	129.71	
CM-SRS.22 Current monitoring relay , 2c/o,B-C=0.3-15A RMS, 24-240VAC/DC	1SVR430840R0500	129.71	
CM-SRS.M1 Current monitoring relay , 2c/o, B-C=3mA-1A RMS, 24-240VAC/DC	1SVR430840R0600	140.46	
CM-SRS.22 Current monitoring relay , 2c/o, B-C=0.3-15A RMS, 110-130VAC	1SVR430841R0500	110.71	
CM-SRS.12 Current monitoring relay , 1c/o, B-C=0.3-15A RMS, 220-240VAC	1SVR430841R1300	110.71	
CM-MSE Thermistor motor protection relay , 1n/o, 110-130VAC	1SVR550800R9300	34.58	
CM-MSE Thermistor motor protection relay , 1n/o, 220-240VAC	1SVR550801R9300	34.58	
CM-MSE Thermistor motor protection relay , 1n/o, 24VAC	1SVR550805R9300	34.58	
CM-PFE Phase sequence monitoring relay , 1c/o, L1-L2-L3=208-440VAC	1SVR550824R9100	43.62	
CM-PVE Phase monitoring relay , 1n/o, L1,2,3-N=185-265VAC	1SVR550870R9400	43.62	
CM-PBE Phase loss monitoring relay , 1n/o, L1,2,3-N=220-240VAC	1SVR550881R9400	40.36	
CM-PBE Phase loss monitoring relay , 1n/o, L1,2,3= 380-440VAC	1SVR550882R9500	40.36	
CM-PAS.41 Three-phase monitoring relay , 2c/o, 0,0,1-30s, L1-L2-L3=3x300-500VAC	1SVR630774R3300	118.10	
CM-PSS.41 Three-phase monitoring relay , 2c/o, 0,0,1-30s, L1-L2-L3=3x400VAC	1SVR630784R3300	99.02	
CM-PVS.41 Three-phase monitoring relay , 2c/o, 0,0,1-30s, L1-L2-L3=3x300-500VAC	1SVR630794R3300	124.18	
CM-MPS.41 Three-phase monitoring relay , 2c/o, 0,0,1-30s, L1-L2-L3=3x300-500VAC	1SVR630884R3300	126.46	
CM-MPS.43 Three-phase monitoring relay , 2c/o, 0,0,1-30s, L1-L2-L3=3x300-500VAC	1SVR630884R4300	150.83	
CM-MPS.21 Three-phase monitoring relay , 2c/o, 0,0,1-30s, L1-L2-L3-N=3x180-280VAC	1SVR630885R3300	132.54	
CM-MPS.23 Three-phase monitoring relay , 2c/o, 0,0,1-30s, L1-L2-L3-N=3x180-280VAC	1SVR630885R4300	156.92	
CM-MPN.62 Three-phase monitoring relay , 2c/o, 0,0,1-30s, L1-L2-L3=3x450-720VAC	1SVR650488R8300	171.40	

Electronic Products and Relays

Power Supplies - Serial Delta Converters

Safety Relays

2CDC271 013 F0606



1SAR501 031 F0001



C573

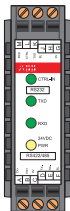

Full range of product and technical information place this part number in a search engine and download
2CDC110004C0206

Power Supplies

Description	Product Hierarchy 400002	
	Order Code	Price
CP-E 5/3.0 Power supply , In:100-240VAC Out: 5VDC/3.0A	1SVR427033R3000	58.71
CP-E 24/5.0 Power supply , In:115/230VAC Out: 24VDC/5A	1SVR427034R0000	94.76
CP-E 24/10.0 Power supply , In:115/230VAC Out: 24VDC/10A	1SVR427035R0000	133.90
CP-E 12/10.0 Power supply , In:115/230VAC Out: 12VDC/10A	1SVR427035R1000	106.09
CP-E 24/20.0 Power supply , In:115/230VAC Out: 24VDC/20A	1SVR427036R0000	183.34
CP-D 24/0.42 Power supply , In: 100-240VAC Out: 24VDC/0.42A	1SVR427041R0000	50.51
CP-A RU Redundancy unit for CP range , power supplies, In: 2x20A, Out: 1x40A	1SVR427071R0000	78.63
CP-A CM Control module for CP-A RU , 2x14-28V adjustable, 2 relay outputs	1SVR427075R0000	33.51
CP-C MM Messaging module for CP-C , VIN>85VAC/90VDC, VOUT>20VDC, remote OFF	1SVR427081R0000	61.05
CP-S 24/5.0 Power supply , In:110-240VAC/100-350VDC Out:DC 24V/5A	1SVR427014R0000	109.18
CP-S 24/10.0 Power supply , In:110-130VAC/220-240VAC Out:DC 24V/10A	1SVR427015R0100	162.74
CP-S 24/20.0 Power supply , In:110-130VAC/220-240VAC Out:DC 24V/20A	1SVR427016R0100	252.35
CP-C 24/5.0 Power supply , In:110-240VAC/100-350VDC Out:DC 24V/5A	1SVR427024R0000	117.42
CP-C 24/10.0 Power supply , In:110-240VAC/100-350VDC Out:DC 24V/10A	1SVR427025R0000	179.22
CP-C 24/20.0 Power supply , In:110-240VAC/100-350VDC Out:DC 24V/20A	1SVR427026R0000	278.10
CP-E 24/0.75 Power supply , In:100-240VAC Out: 24VDC/0.75A	1SVR427030R0000	47.38
CP-E 48/0.62 Power supply , In:100-240VAC Out: 48VDC/0.62A	1SVR427030R2000	61.80
CP-E 24/1.25 Power supply , In:100-240VAC Out: 24VDC/1.25A	1SVR427031R0000	51.50
CP-E 48/1.25 Power supply , In:100-240VAC Out: 48VDC/1.25A	1SVR427031R2000	78.28
CP-E 24/2.5 Power supply , In:100-240VAC Out: 24VDC/2.5A	1SVR427032R0000	64.89
CP-E 12/2.5 Power supply , In:100-240VAC Out: 12VDC/2.5A	1SVR427032R1000	58.71

Safety Relays

Description	Product Hierarchy 400007	
	Order Code	Price
C573 Safety relay , 24VAC/DC, 3n/o,1n/c	1SAR501031R0001	145.83
C572 Safety relay , 24VAC, 3n/o, 2n/c	1SAR501032R0002	201.32
C572 Safety relay , 24VDC, 3n/o, 2n/c	1SAR501032R0003	256.17

Serial Delta Converters

Description	Product Hierarchy 400003	
	Order Code	Price
ILPH RS422-485/RS422-RS485 Serial Data Converter	1SNA684212R2200	205.92
ILPH RS232/RS485-422 24VDC Serial Data Converter	1SNA684231R2500	129.33
ILPH RS232/RS485-422 Isolated Serial Data Converter	1SNA684233R2700	215.55
ILPH RS485-422/RS232 115/230V Serial Data Converter	1SNA684334R2400	215.55

Electronic Products and Relays

Analogue Signal Converters

Interface Relays & Opt. Couplers

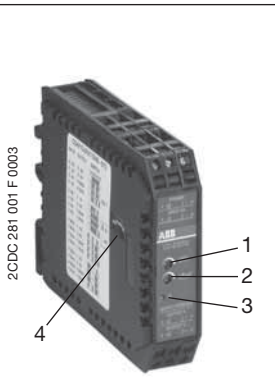

- 1 Gain adjustment
- 2 Offset adjustment
- 3 U: green LED - supply voltage
- 4 DIP switch for input and output configuration (only available on universal devices)

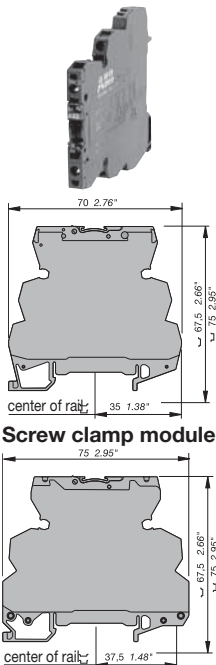

Full range of product and technical information place this part number in a search engine and download

2CDC110004C0206

Analogue Signal Converters	Product Hierarchy 400001	
Description	Order Code	Price
CC-E I/I-1 Current / current isolator , 1 channel, loop-powered	1SVR010200R1600	144.86
CC-E/STD Signal converter, univers. , V/I / V/I, 24VDC	1SVR011700R0000	144.08
CC-E/TC Temp. converter, univers. , J/K / V/I, 24VDC	1SVR011702R2600	150.62
CC-E/STD Signal converter, univers. , V/I / V/I, 110-240VAC	1SVR011705R2100	144.08
CC-E V/V Signal converter, singlef. , 0-10V / 0-10V, 24VDC	1SVR011710R2100	129.68
CC-E V/I Signal converter, singlef. , 0-10V / 0-20mA, 24VDC	1SVR011711R1600	129.68
CC-E V/I Signal converter, singlef. , 0-10V / 4-20mA, 24VDC	1SVR011712R1700	129.68
CC-E I/V Signal converter, singlef. , 0-20mA / 0-10V, 24VDC	1SVR011713R1000	129.68
CC-E I/I Signal converter, singlef. , 0-20mA / 0-20mA, 24VDC	1SVR011714R1100	129.68
CC-E I/I Signal converter, singlef. , 4-20mA / 4-20mA, 24VDC	1SVR011718R2500	129.68
CC-E I/I Signal converter, singlef. , 4-20mA / 4-20mA, 110-240VAC	1SVR011728R2700	129.68
CC-U/STD Universal signal converter , 24-48VDC / 24VAC 50/60Hz	1SVR040000R1700	191.12
CC-U/STD Universal signal converter , 110-240VAC 50/60Hz / 100-300VDC	1SVR040001R0400	191.12
CC-U/RTD Universal signal converter , 24-48VDC / 24VAC 50/60Hz	1SVR040002R0500	230.52
CC-U/RTD Universal signal converter , 110-240VAC 50/60Hz / 100-300VDC	1SVR040003R0600	230.52
CC-U/TC Universal signal converter , 24-48VDC / 24VAC 50/60Hz	1SVR040004R0700	228.57
CC-U/TC Universal signal converter , 110-240VAC 50/60Hz / 100-300VDC	1SVR040005R0000	228.57
CC-U/I Universal signal converter , 24-48VDC / 24VAC 50/60Hz	1SVR040006R0100	225.95
CC-U/I Universal signal converter , 110-240VAC 50/60Hz / 100-300VDC	1SVR040007R0200	225.95
CC-U/V Universal signal converter , 24-48VDC / 24VAC 50/60Hz	1SVR040008R1300	225.95
CC-U/V Universal signal converter , 110-240VAC 50/60Hz / 100-300VDC	1SVR040009R1400	225.95
CC-U/STDR Universal signal converter , 24-48VDC / 24VAC 50/60Hz	1SVR040010R0000	157.18
CC-U/STDR Universal signal converter , 110-240VAC 50/60Hz / 100-300VDC	1SVR040011R2500	157.18
CC-U/RTDR Universal signal converter , 24-48VDC / 24VAC 50/60Hz	1SVR040012R2600	177.75
CC-U/RTDR Universal signal converter , 110-240VAC 50/60Hz / 100-300VDC	1SVR040013R2700	177.75
CC-U/TCR Universal signal converter , 24-48VDC / 24VAC 50/60Hz	1SVR040014R2000	177.75
CC-U/TCR Universal signal converter , 110-240VAC 50/60Hz / 100-300VDC	1SVR040015R2100	177.75

Interface Relays and Connectors	Product Hierarchy 400005	
Description	Order Code	Price
RB121B Relay	1SNA630004R0300	23.06
M4/9.PV270/130	1SNA007013R1300	4.58
EBA 125V	1SNA010103R2100	69.47
RM111 24VCC	1SNA020032R1600	18.47
EM4PC 20 000 Series Patchboard 4 way	1SNA020260R1300	20.25
EM8PC 20 000 Series Patchboard 8 way	1SNA020261R0000	39.51
EM16D Diode Board	1SNA020265R0400	43.64
Component Carrier, 8 clamp	1SNA103305R0200	7.29
AF50 Accro Din 1/3	1SNA103323R2300	0.39
AF76 Acro Din 1/3	1SNA103324R2400	0.5
FEF 12-1 End Block	1SNA103332R2400	0.38
ENF5, 5.08mm Spacer	1SNA103335R2700	0.55
ENF12, 12.7mm Spacer	1SNA103337R2100	0.53

Electronic Products and Relays

Interface Relays & Opt. Couplers

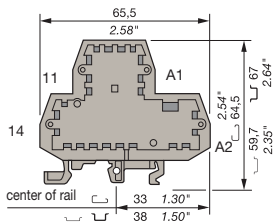

M 4/9.R111...

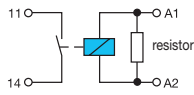

M 4/9.R111

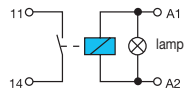

M 4/9.R111L

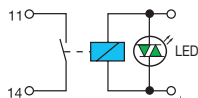

M 4/9.R111L



Full range of product and technical information place this part number in a search engine and download
2CDC110004C0206

Interface Relays & Opt. Couplers

Product Hierarchy 40005

Description	Order Code	Price
ENF25, 25.4mm Spacer	1SNA103338R0200	0.58
EEF 12-2, 12.7mm Cover Block	1SNA103339R0300	0.71
ENF101, 100mm Spacer	1SNA103356R0400	0.88
PF11.0, 11 000 Series End Plate Left	1SNA103595R1500	0.61
PF12.0, 11 000 Series End Plate Right	1SNA103596R1600	0.61
PF 13 0, 11 000 Series Deep End Plate Right	1SNA103762R0300	1.74
AFSE 71 D RHS Foot/End Section	1SNA103796R2600	1.14
AFSE 71 G LHS Foot/End Section	1SNA103797R2700	1.14
20 000 Series EXTRUDE SE71X ORANGE L=1M	1SNA103868R0600	27.24
20 000 Series EXTRUDE SE100X ORANGE L=1M	1SNA103885R1000	27.24
AFSE 100 D 100mm Carrier Foot RHS	1SNA103968R0200	1.42
AFSE 100 G 100mm Carrier Foot LHS	1SNA103969R0300	1.42
PF N1, 3.5mm End Section	1SNA113091R0000	0.55
PF N2, 8.5mm End Section	1SNA113095R0400	0.55
PF N3	1SNA114289R2400	1.10
Empty Function Unit 8 clamp	1SNA114533R0000	6.53
PF 11G, 11 000 Series End Plate LHS	1SNA116519R1400	0.61
PF 12G, 11 000 Series End Plate RHS	1SNA116520R1100	0.61
BFU2 S 12G, 11 000 Series 12 Clamp Unit	1SNA116522R0700	8.29
BFU2 S 6G, 11 000 Series 6 Clamp Unit	1SNA116523R0000	6.34
PF 13 G, 11 000 Series Deep End Plate Right	1SNA116718R2300	1.74
CI 115, Perforated PCB	1SNA174021R1600	3.36
20 000 series Screw, pozi 2 x 8mm	1SNA174582R1600	0.05
CI 11P1, 11 000 Series PCB	1SNA175207R0700	7.40
VIS CB X ST3,3X15 PL TS203	1SNA178135R2100	0.05
SC612, R600 Separator End Section	1SNA290474R0200	0.66
M4/9 R111L-12VDC Relay	1SNA607001R2000	9.41
M 4/9 R111L-24VDC Relay	1SNA607002R0700	9.41
M 4/9 R111-12VDC Relay	1SNA607029R0100	8.89
M 4/9 R111-24VDC Relay	1SNA607030R0600	8.89
D2.5/5-R121L 24VDC Relay	1SNA607201R1300	10.37

Electronic Products and Relays

Interfast Wiring System



PLC Wiring System

Description	Product Hierarchy 500001	
	Order Code	Price
BFM ELCO 56/56 - 1	1SNA020135R1200	96.92
BFM ELCO 56/56 - 2	1SNA020136R1300	96.92
BFM ELCO 38/38 - 1	1SNA020137R1400	109.34
BFM ELCO 38/38 - 2	1SNA020138R2500	109.34
BFM SUB 9M HR Interface 9 way	1SNA020351R0200	23.21
BFM SUB25M HR Interface 25 way	1SNA020353R0400	34.80
BNMS T24V-1, 24VDC Opto	1SNA031800R2100	17.22
BNMS T24V-1, 24VAC 100mA Opto	1SNA031802R1700	19.50
BNMS P5V-1, 5VDC 30VDC/2A Opto	1SNA031814R0200	22.29
BNMS P24V-1, 24VDC 30VDC/2A Opto	1SNA031815R0300	22.29
BNMS R24V-1	1SNA031820R1400	4.79
BNMS ST1	1SNA031829R1100	1.91
BNMS ST2	1SNA031830R1600	2.12
PCMS 20 Wat Jumper Bar Red	1SNA205564R0300	2.27
BJ612-10 Way Jumper Bar Grey	1SNA290488R0100	0.94

Interface Relays & Opt. Couplers

Description	Product Hierarchy 400005	
	Order Code	Price
D2.5/5-MP 24VDC Base without plug	1SNA607222R0700	5.41
D2.5/5-MP1 Base without plug	1SNA607223R0000	7.00
D2.5/5-MP Grey	1SNA607224R0100	9.69
OBC1000-5VDC Opto	1SNA608014R2200	30.02
OBC0100-24VDC Opto	1SNA608017R0600	20.16
OBC1000-24VDC Opto	1SNA608018R1700	30.02
OBA 1000 24VDC Opto	1SNA608019R1000	29.27
ORA111-24VDC Long Life Opto	1SNA608069R2200	41.81
RB121A-110-220VAC-DC Relay	1SNA610132R2300	26.50
RB121-12VDC Relay 1SPDT	1SNA630001R0000	20.15
RB121A-24V AC/DC Relay 1 SPDT	1SNA630002R0100	20.15
RB121A-48VAC/DC Relay 1 SPDT	1SNA630003R0200	20.15
RB121B 110VAC/50HZ Relay 1 SPDT	1SNA630004R0300	23.06
RB121B 230VAC/50HZ Relay 1SPDT	1SNA630006R0500	24.42
RB122A 24VAC/DC Relay 1 DPDT	1SNA630011R2100	36.09
RB121A 24vac/dc SPDT Relay 10mA - 6A	1SNA645001R0300	11.38
RB121A 115vac/dc SPDT Relay 10mA - 6A	1SNA645003R0500	13.65
RB121A 230vac/dc SPDT Relay 10mA - 6A	1SNA645004R0400	14.21
RB121A 24vac/dc SPDT Relay 1mA - 6A	1SNA645005R0700	11.38
RB122A 24vac/dc DPDT Relay 1mA - 6A	1SNA645012R2500	16.12
RB122A 230vac/dc DPDT Relay 1mA - 6A	1SNA645013R2600	22.74
RB111A 24vac/dc 1NO Relay 10mA - 6A	1SNA645014R2700	9.86
OBIC0100 24vdc Opto	1SNA645021R2600	15.26
RB121 12vdc SPDT Relay 10mA - 6A	1SNA645035R2400	14.21

Electronic Products and Relays

Interfast Wiring System

1

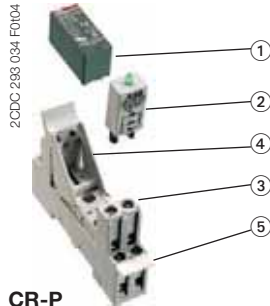

CR-P

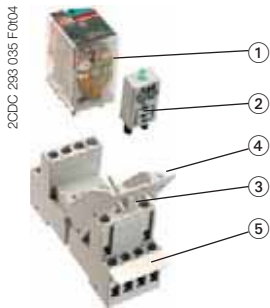

CR-M

- ① Interface relay
- ② Pluggable function module
- ③ Socket
- ④ Holder
- ⑤ Marker



CR-M4SS



Full range of product and technical information place this part number in a search engine and download
2CDC110004C0206

Pluggable Relays

Description	Product Hierarchy 50003	
	Order Code	Price
CR-P024DC1 Pluggable interface relay , 1c/o, A1-A2=24VDC, 250V/16A	1SVR405600R1000	1.86
CR-P230AC1 Pluggable interface relay , 1c/o, A1-A2=230VAC, 250V/16A	1SVR405600R3000	3.66
CR-P024AC2 Pluggable interface relay , 2c/o, A1-A2=24VAC, 250V/8A	1SVR405601R0000	2.60
CR-P024DC2 Pluggable interface relay , 2c/o, A1-A2=24VDC, 250V/8A	1SVR405601R1000	2.21
CR-P230AC2 Pluggable interface relay , 2c/o, A1-A2=230VAC, 250V/8A	1SVR405601R3000	4.05
CR-P012DC2 Pluggable interface relay , 2c/o, A1-A2=12VDC, 250V/8A	1SVR405601R4000	2.21
CR-M024AC2 Pluggable interface relay , 2c/o, A1-A2=24VAC, 250V/12A	1SVR405611R0000	4.33
CR-M024DC2 Pluggable interface relay , 2c/o, A1-A2=24VDC, 250V/12A	1SVR405611R1000	4.11
CR-M024DC2L Pluggable interface relay , 2c/o, A1-A2=24VDC, 250V/12A, LED	1SVR405611R1100	4.92
CR-M230AC2 Pluggable interface relay , 2c/o, A1-A2=230VAC, 250V/12A	1SVR405611R3000	4.81
CR-M012DC2 Pluggable interface relay , 2c/o, A1-A2=12VDC, 250V/12A	1SVR405611R4000	4.11
CR-M012DC2L Pluggable interface relay , 2c/o, A1-A2=12VDC, 250V/12A, LED	1SVR405611R4100	4.92
CR-M110AC2 Pluggable interface relay , 2c/o, A1-A2=110VAC, 250V/12A	1SVR405611R7000	4.47
CR-M110AC2L Pluggable interface relay , 2c/o, A1-A2=110VAC, 250V/12A, LED	1SVR405611R7100	5.26
CR-M024AC3 Pluggable interface relay , 3c/o, A1-A2=24VAC, 250V/10A	1SVR405612R0000	4.47
CR-M024DC3 Pluggable interface relay , 3c/o, A1-A2=24VDC, 250V/10A	1SVR405612R1000	4.25
CR-M024DC3L Pluggable interface relay , 3c/o, A1-A2=24VDC, 250V/10A, LED	1SVR405612R1100	5.06
CR-M230AC3 Pluggable interface relay , 3c/o, A1-A2=230VAC, 250V/10A	1SVR405612R3000	4.95
CR-M012DC3 Pluggable interface relay , 3c/o, A1-A2=12VDC, 250V/10A	1SVR405612R4000	4.25
CR-M110AC3 Pluggable interface relay , 3c/o, A1-A2=110VAC, 250V/10A	1SVR405612R7000	4.60
CR-M024AC4 Pluggable interface relay , 4c/o, A1-A2=24VAC, 250V/6A	1SVR405613R0000	4.60
CR-M024AC4L Pluggable interface relay , 4c/o, A1-A2=24VAC, 250V/6A, LED	1SVR405613R0100	5.41
CR-M024DC4 Pluggable interface relay , 4c/o, A1-A2=24VDC, 250V/6A	1SVR405613R1000	4.39
CR-M024DC4L Pluggable interface relay , 4c/o, A1-A2=24VDC, 250V/6A, LED	1SVR405613R1100	5.20
CR-M230AC4 Pluggable interface relay , 4c/o, A1-A2=230VAC, 250V/6A	1SVR405613R3000	5.10
CR-M230AC4L Pluggable interface relay , 4c/o, A1-A2=230VAC, 250V/6A, LED	1SVR405613R3100	5.90
CR-M012DC4 Pluggable interface relay , 4c/o, A1-A2=12VDC, 250V/6A	1SVR405613R4000	4.39
CR-M012DC4L Pluggable interface relay , 4c/o, A1-A2=12VDC, 250V/6A, LED	1SVR405613R4100	5.20
CR-M110AC4 Pluggable interface relay , 4c/o, A1-A2=110VAC, 250V/6A	1SVR405613R7000	4.75
CR-M110AC4L Pluggable interface relay , 4c/o, A1-A2=110VAC, 250V/6A, LED	1SVR405613R7100	5.55
CR-M110DC4L Pluggable interface relay , 4c/o, A1-A2=110VDC, 250V/6A, LED	1SVR405613R8100	5.77
CR-U024AC2 Pluggable interface relay , 2c/o, A1-A2=24VAC, 250V/10A	1SVR405621R0000	6.25
CR-U230AC2 Pluggable interface relay , 2c/o, A1-A2=230VAC, 250V/10A	1SVR405621R3000	6.54
CR-U230AC3 Pluggable interface relay , 3c/o, A1-A2=230VAC, 250V/10A	1SVR405622R3000	6.78
CR-U110AC3 Pluggable interface relay , 3c/o, A1-A2=110VAC, 250V/10A	1SVR405622R7000	6.61
CR-PLS Logical socket , for 1c/o or 2c/o CR-P relays	1SVR405650R0000	2.81
CR-PSS Standard socket , for 1c/o or 2c/o CR-P relays	1SVR405650R1000	2.67
CR-P/M 22 Pluggable module , polarity protection, 6-230VDC, A1+, A2-	1SVR405651R0000	0.81

Electronic Products and Relays

Interfast Wiring System

2CDC 291 042 F0b04



CR-M4LS

2CDC 291 037 F0b04



Full range of product and technical information place this part number in a search engine and download

2CDC110004C0206

Pluggable Relays

Description	Product Hierarchy 500003	
	Order Code	Price
CR-M2LC Logical socket , for 2c/o CR-M relay	1SVR405651R1200	3.66
CR-M3SS Standard socket , for 3c/o CR-M relay	1SVR405651R2000	2.74
CR-M4SS Standard socket , for 2c/o or 4c/o CR-M relay	1SVR405651R3000	2.96
CR-M4LS Logical socket , for 2c/o or 4c/o CR-M relay	1SVR405651R3100	3.09
CR-M4LC Logical socket , for 2c/o or 4c/o CR-M relay	1SVR405651R3200	4.07
CR-P/M 42 Pluggable module , diode and LED red, 6-24VDC, A1 +, A2-	1SVR405652R0000	1.66
CR-P/M 62C Pluggable module , varistor and LED red, 6-24VAC/DC	1SVR405655R0000	2.6
CR-P/M 72 Pluggable module , varistor, without LED, 24VAC	1SVR405656R0000	1.86
CR-PH Holder for CR-P socket ,	1SVR405659R0000	0.22
CR-MH Holder for CR-M socket ,	1SVR405659R1000	0.36
CR-U3S Socket , for 3c/o CR-U relay	1SVR405660R0000	3.12
CR-U3E Socket , for 3c/o CR-U relay	1SVR405660R0100	2.96
CR-UH Holder for CR-U socket ,	1SVR405669R0000	1.02
CR-U2S Socket , for 2c/o CR-U relay	1SVR405670R0000	3.05
CR-P024AC1 Pluggable interface relay , 1c/o, A1-A2=24VAC, 250V/16A	1SVR405600R0000	2.21
CR-M230AC3L Pluggable interface relay , 3c/o, A1-A2=230VAC, 250V/10A, LED	1SVR405612R3100	5.77
CR-U024AC3 Pluggable interface relay , 3c/o, A1-A2=24VAC, 250V/10A	1SVR405622R0000	6.47
CR-P/M 42V Pluggable module , diode and LED green, 6-24VDC, A1 +, A2-	1SVR405652R1000	1.66
CR-MH1 Metal holder for CR-M sockets ,	1SVR405659R1100	0.29

Notes

1

System ProM compact

S200 compact Series MCBs	44 - 50
S800 Series MCBs	51
F200 compact Series RCCBs	52
DDA200 compact Series RCD Blocks	53
DS271 Series RCB0s	54
S200 & F200 compact Series Accessories	55-56
Modular Devices	57

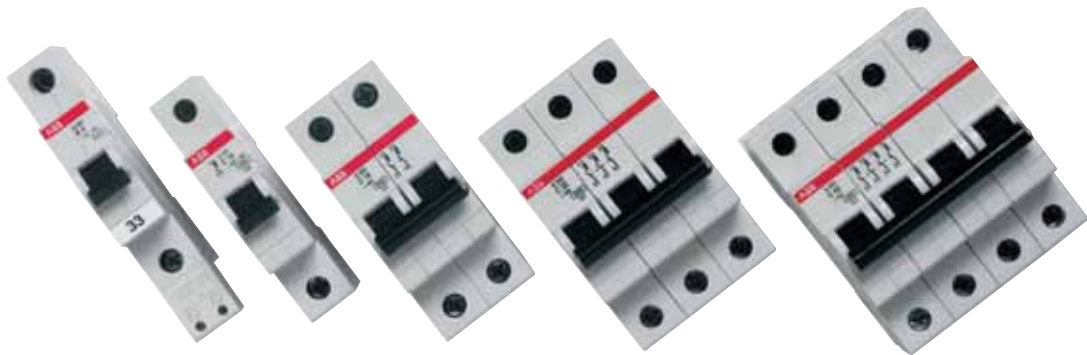
**Installation Equipment**

Full range of product
and technical information
place this part number
in a search engine and
download
2CSC400002D0208

Installation equipment

Tripping Characteristics

Tripping characteristics

Acc. to	Tripping characteristic and rated current	Thermal release ²⁾		Tripping time	Electromagnetic release ¹⁾		
		Current: conventional non-tripping c.	conventional tripping c.		Currents: hold current surges	trip at least at	Tripping time
IEC/EN 60898	B 6 to 63 A	$1.13 \cdot I_n$	$1.45 \cdot I_n$	$> 1 \text{ h}$ $< 1 \text{ h}$	$3 \cdot I_n$	$5 \cdot I_n$	$> 0.1 \text{ s}$ $< 0.1 \text{ s}$
	C 0.5 to 63 A	$1.13 \cdot I_n$	$1.45 \cdot I_n$	$> 1 \text{ h}$ $< 1 \text{ h}$	$5 \cdot I_n$	$10 \cdot I_n$	$> 0.1 \text{ s}$ $< 0.1 \text{ s}$
	D 0.5 to 63 A	$1.13 \cdot I_n$	$1.45 \cdot I_n$	$> 1 \text{ h}$ $< 1 \text{ h}$	$10 \cdot I_n$	$20 \cdot I_n$	$> 0.1 \text{ s}$ $< 0.1 \text{ s}$
DIN VDE 0660/9.82	K 0.5 to 63 A	$1.05 \cdot I_n$	$1.2 \cdot I_n$	$> 1 \text{ h}$ $< 1 \text{ h}$	not applicable		
IEC/EN 60947-2 DIN VDE 0660 8/69 Part 101		$1.05 \cdot I_n$	$1.2 \cdot I_n$ $1.5 \cdot I_n$ $6.0 \cdot I_n$	$> 2 \text{ h}$ $< 1 \text{ h}^{3)}$ $< 2 \text{ min.}^{3)}$ $> 2 \text{ s (T1)}$	$10 \cdot I_n$	$14 \cdot I_n$	$> 0.2 \text{ s}$ $< 0.2 \text{ s}$
DIN VDE 0660/9.82	Z 0.5 to 63 A	$1.05 \cdot I_n$	$1.2 \cdot I_n$	$> 1 \text{ h}$ $< 1 \text{ h}$	not applicable		
IEC/EN 60947-2 DIN VDE 0660 8/69 Part 101		$1.05 \cdot I_n$	$1.2 \cdot I_n$ $1.5 \cdot I_n$ $6.0 \cdot I_n$	$> 2 \text{ h}$ $< 1 \text{ h}^{3)}$ $< 2 \text{ min.}^{3)}$ $> 2 \text{ s (T1)}$	$2 \cdot I_n$	$3 \cdot I_n$	$> 0.2 \text{ s}$ $< 0.2 \text{ s}$

1) The indicated tripping values of electromagnetic tripping devices apply to a frequency range of 16 2/3...60 Hz. In the case of diverging frequencies or direct current, see paragraph "Variation of tripping threshold of MCBs, according to network frequency" (page 6/7)

2) The thermal releases are calibrated to a nominal reference ambient temperature; for Z and K, the value is 20 °C, for B and C = 30 °C. In the case of higher ambient temperatures, the current values fall by ca. 6 % for each 10 K temperature rise.
3) As from operating temperature (after $I_1 > 1 \text{ h}$ or, as applicable, 2 h).

Characteristics B, C, D

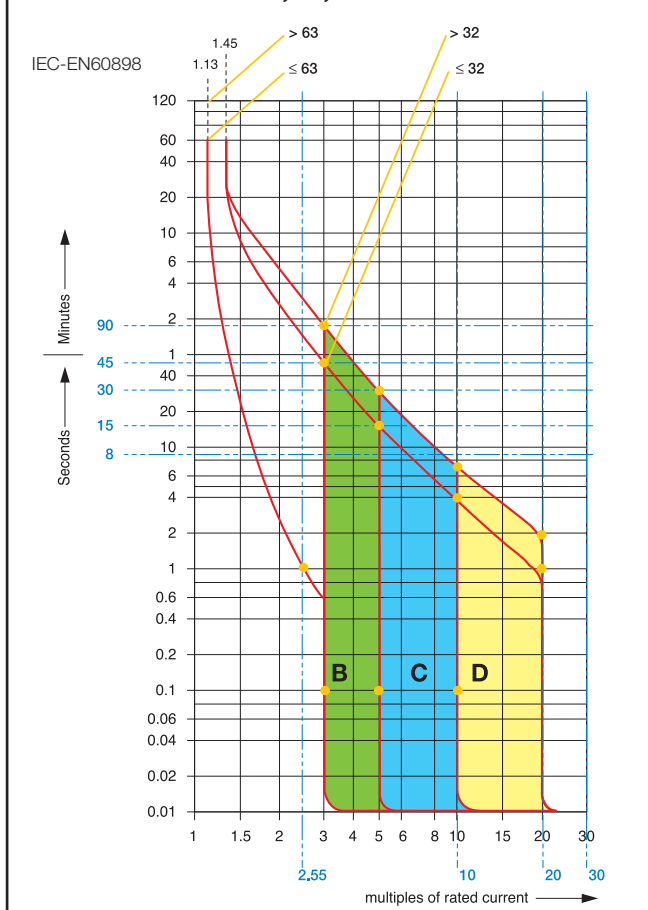

Characteristics K, Z

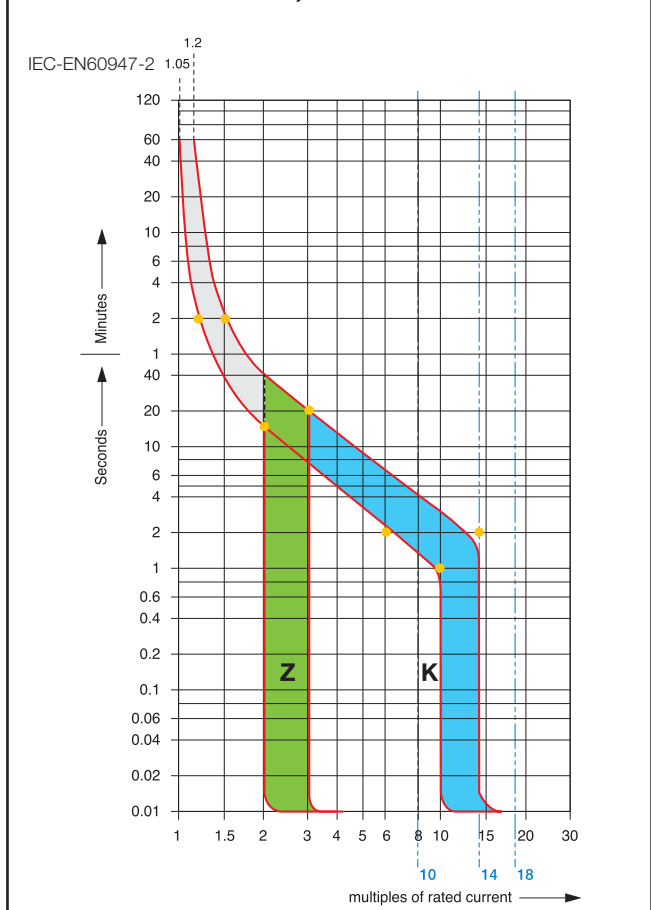

System ProM compact

Type S200 Series M-B

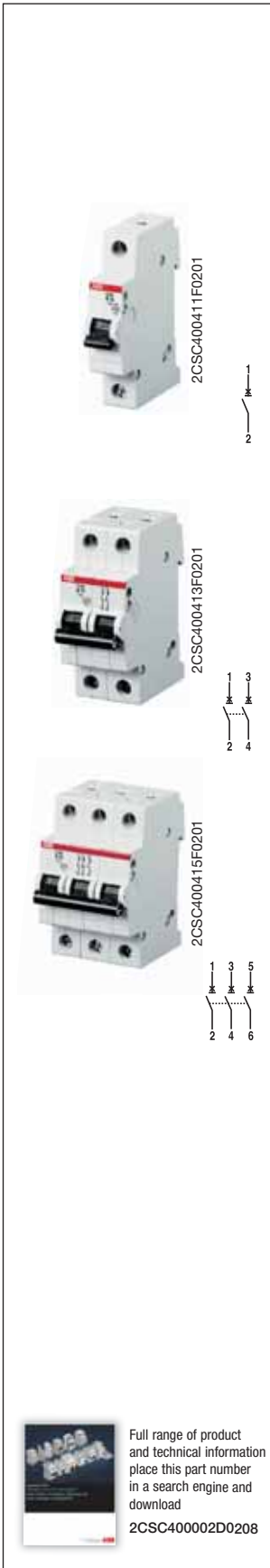

Type M-B 10kA

		Product Hierarchy 2400004		
Rated Current (A)		Order Code	Price	
6	Single Pole	S201MB6	2CDS271001R0065	10.01
10		S201MB10	2CDS271001R0105	9.18
16		S201MB16	2CDS271001R0165	9.18
20		S201MB20	2CDS271001R0205	9.18
25		S201MB25	2CDS271001R0255	9.18
32		S201MB32	2CDS271001R0325	9.18
40		S201MB40	2CDS271001R0405	10.01
50		S201MB50	2CDS271001R0505	10.53
63		S201MB63	2CDS271001R0635	10.65
Rated Current (A)		Order Code	Price	
6	Double Pole	S202MB6	2CDS272001R0065	28.75
10		S202MB10	2CDS272001R0105	26.41
16		S202MB16	2CDS272001R0165	9.18
20		S202MB20	2CDS272001R0205	9.18
25		S202MB25	2CDS272001R0255	9.18
32		S202MB32	2CDS272001R0325	9.18
40		S202MB40	2CDS272001R0405	10.01
50		S202MB50	2CDS272001R0505	10.53
63		S202MB63	2CDS272001R0635	30.46
Rated Current (A)		Order Code	Price	
6	Triple Pole	S203MB6	2CDS273001R0065	42.69
10		S203MB10	2CDS273001R0105	40.04
16		S203MB16	2CDS273001R0165	40.04
20		S203MB20	2CDS273001R0205	40.04
25		S203MB25	2CDS273001R0255	40.04
32		S203MB32	2CDS273001R0325	40.04
40		S203MB40	2CDS273001R0405	42.69
50		S203MB50	2CDS273001R0505	44.83
63		S203MB63	2CDS273001R0635	45.26



System ProM compact

Type S200 Series M-C

2



Full range of product and technical information place this part number in a search engine and download

2CSC400002D0208

Type M-C 10kA

Rated Current (A)	Single Pole	Product Hierarchy 2400004	
		Order Code	Price
1	S201MC1	2CDS271001R0014	10.65
2	S201MC2	2CDS271001R0024	10.53
3	S201MC3	2CDS271001R0034	10.53
4	S201MC4	2CDS271001R0044	10.32
6	S201MC6	2CDS271001R0064	10.01
8	S201MC8	2CDS271001R0084	10.01
10	S201MC10	2CDS271001R0104	9.18
13	S201MC13	2CDS271001R0134	9.18
16	S201MC16	2CDS271001R0164	9.18
20	S201MC20	2CDS271001R0204	9.18
25	S201MC25	2CDS271001R0254	9.18
32	S201MC32	2CDS271001R0324	9.18
40	S201MC40	2CDS271001R0404	10.01
50	S201MC50	2CDS271001R0504	10.53
63	S201MC63	2CDS271001R0634	10.65

Rated Current (A)	Double Pole	Product Hierarchy 2400004	
		Order Code	Price
1	S202MC1	2CDS272001R0014	30.46
2	S202MC2	2CDS272001R0024	30.20
3	S202MC3	2CDS272001R0034	30.20
4	S202MC4	2CDS272001R0044	29.65
6	S202MC6	2CDS272001R0064	28.75
8	S202MC8	2CDS272001R0084	26.41
10	S202MC10	2CDS272001R0104	26.41
13	S202MC13	2CDS272001R0134	26.41
16	S202MC16	2CDS272001R0164	26.41
20	S202MC20	2CDS272001R0204	26.41
25	S202MC25	2CDS272001R0254	26.41
32	S202MC32	2CDS272001R0324	26.41
40	S202MC40	2CDS272001R0404	28.82
50	S202MC50	2CDS272001R0504	30.20
63	S202MC63	2CDS272001R0634	30.46

Rated Current (A)	Triple Pole	Product Hierarchy 2400004	
		Order Code	Price
1	S203MC1	2CDS273001R0014	45.26
2	S203MC2	2CDS273001R0024	44.83
3	S203MC3	2CDS273001R0034	44.83
4	S203MC4	2CDS273001R0044	44.00
6	S203MC6	2CDS273001R0064	42.69
10	S203MC10	2CDS273001R0104	40.04
16	S203MC16	2CDS273001R0164	40.04
20	S203MC20	2CDS273001R0204	40.04
25	S203MC25	2CDS273001R0254	40.04
32	S203MC32	2CDS273001R0324	40.04
40	S203MC40	2CDS273001R0404	42.69
50	S203MC50	2CDS273001R0504	44.83
63	S203MC63	2CDS273001R0634	45.26

System ProM compact

Type S200 Series D

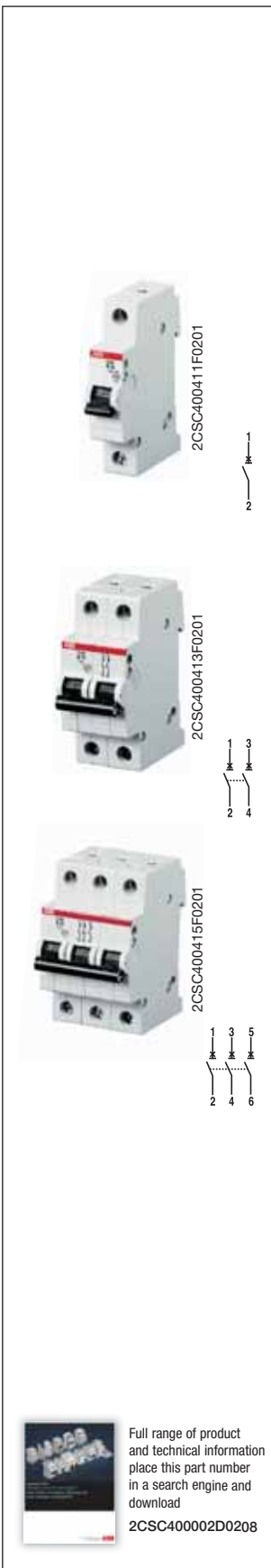

Type D 6kA

Rated Current (A)	Single Pole	Product Hierarchy 2400004	
		Order Code	Price
1	S201D1	2CDS251001R0011	11.42
2	S201D2	2CDS251001R0021	11.31
3	S201D3	2CDS251001R0031	11.31
4	S201D4	2CDS251001R0041	11.10
6	S201D6	2CDS251001R0061	10.79
10	S201D10	2CDS251001R0101	9.90
16	S201D16	2CDS251001R0161	9.90
20	S201D20	2CDS251001R0201	9.90
25	S201D25	2CDS251001R0251	9.90
32	S201D32	2CDS251001R0321	9.90
40	S201D40	2CDS251001R0401	10.79
50	S201D50	2CDS251001R0501	11.31
63	S201D63	2CDS251001R0631	11.42

Rated Current (A)	Double Pole	Product Hierarchy 2400004	
		Order Code	Price
1	S202D1	2CDS252001R0011	32.68
2	S202D2	2CDS252001R0021	32.38
3	S202D3	2CDS252001R0031	32.38
4	S202D4	2CDS252001R0041	31.74
6	S202D6	2CDS252001R0061	30.85
10	S202D10	2CDS252001R0101	28.28
16	S202D16	2CDS252001R0161	28.28
20	S202D20	2CDS252001R0201	28.28
25	S202D25	2CDS252001R0251	28.28
32	S202D32	2CDS252001R0321	28.28
40	S202D40	2CDS252001R0401	30.85
50	S202D50	2CDS252001R0501	32.38
63	S202D63	2CDS252001R0631	32.68

Rated Current (A)	Triple Pole	Product Hierarchy 2400004	
		Order Code	Price
1	S203D1	2CDS253001R0011	48.46
2	S203D2	2CDS253001R0021	48.03
3	S203D3	2CDS253001R0031	48.03
4	S203D4	2CDS253001R0041	47.12
6	S203D6	2CDS253001R0061	45.73
10	S203D10	2CDS253001R0101	42.87
16	S203D16	2CDS253001R0161	42.87
20	S203D20	2CDS253001R0201	42.87
25	S203D25	2CDS253001R0251	42.87
32	S203D32	2CDS253001R0321	42.87
40	S203D40	2CDS253001R0401	45.73
50	S203D50	2CDS253001R0501	48.03
63	S203D63	2CDS253001R0631	48.46

System ProM compact

Type S200 Series K

2

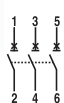

Full range of product and technical information place this part number in a search engine and download
2CSC400002D0208

Type K 6kA

Rated Current (A)	Single Pole	Product Hierarchy 2400004	
		Order Code	Price
0.5	S201K0.5	2CDS251001R0157	12.32
1	S201K1	2CDS251001R0217	12.32
2	S201K2	2CDS251001R0277	12.32
3	S201K3	2CDS251001R0317	12.32
4	S201K4	2CDS251001R0337	12.32
6	S201K6	2CDS251001R0377	12.32
8	S201K8	2CDS251001R0407	12.32
10	S201K10	2CDS251001R0427	11.24
16	S201K16	2CDS251001R0467	11.24
20	S201K20	2CDS251001R0487	12.32
25	S201K25	2CDS251001R0517	12.75
32	S201K32	2CDS251001R0537	12.75

Rated Current (A)	Double Pole	Product Hierarchy 2400004	
		Order Code	Price
0.5	S202K0.5	2CDS252001R0157	34.17
1	S202K1	2CDS252001R0217	34.17
2	S202K2	2CDS252001R0277	34.17
3	S202K3	2CDS252001R0317	34.17
4	S202K4	2CDS252001R0337	34.17
6	S202K6	2CDS252001R0377	34.17
8	S202K8	2CDS252001R0407	34.17
10	S202K10	2CDS252001R0427	29.67
16	S202K16	2CDS252001R0467	29.67
20	S202K20	2CDS252001R0487	32.73
25	S202K25	2CDS252001R0517	33.81
32	S202K32	2CDS252001R0537	33.81
40	S202K40	2CDS252001R0557	39.75
50	S202K50	2CDS252001R0577	41.04
63	S202K63	2CDS252001R0607	44.09

Rated Current (A)	Triple Pole	Product Hierarchy 2400004	
		Order Code	Price
1	S203K1	2CDS253001R0217	51.76
2	S203K2	2CDS253001R0277	51.76
4	S203K4	2CDS253001R0337	51.76
6	S203K6	2CDS253001R0377	51.76
8	S203K8	2CDS253001R0407	51.76
10	S203K10	2CDS253001R0427	44.76
16	S203K16	2CDS253001R0467	44.76
20	S203K20	2CDS253001R0487	49.52
32	S203K32	2CDS253001R0537	51.14
40	S203K40	2CDS253001R0557	58.96
50	S203K50	2CDS253001R0577	62.28
63	S203K63	2CDS253001R0607	67.03

System ProM compact

Type S200 Series PK and PC



Type PK

Rated Current (A)	Single Pole	Product Hierarchy 2400002	
		Order Code	Price
3	S201PK3 25kA	2CDS281001R0317	19.04
6	S201PK6 25kA	2CDS281001R0377	19.04
10	S201PK10 25kA	2CDS281001R0427	16.92
20	S201PK20 25kA	2CDS281001R0487	19.34
32	S201PK32 15kA	2CDS281001R0537	23.29
40	S201PK40 15kA	2CDS281001R0557	26.96

Rated Current (A)	Double Pole	Order Code	Price
1	S202PK1 25kA	2CDS282001R0217	41.59
2	S202PK2 25kA	2CDS282001R0277	41.59
3	S202PK3 25kA	2CDS282001R0317	41.59
4	S202PK4 25kA	2CDS282001R0337	41.59
6	S202PK6 25kA	2CDS282001R0377	41.59
8	S202PK8 25kA	2CDS282001R0407	41.59
16	S202PK16 25kA	2CDS282001R0467	37.73
20	S202PK20 25kA	2CDS282001R0487	41.95
25	S202PK25 25kA	2CDS282001R0517	44.25
40	S202PK40 15kA	2CDS282001R0557	57.52
50	S202PK50 15kA	2CDS282001R0577	65.31

Rated Current (A)	Triple Pole	Order Code	Price
6	S203PK6 25kA	2CDS283001R0377	62.65
16	S203PK16 25kA	2CDS283001R0467	57.04
32	S203PK32 15kA	2CDS283001R0537	75.35

Type PC

Rated Current (A)	Single Pole	Product Hierarchy 2400002	
		Order Code	Price
16	S201PC16 25kA	2CDS281001R0164	13.34
20	S201PC20 25kA	2CDS281001R0204	13.34
32	S201PC32 15kA	2CDS281001R0324	13.34



Full range of product and technical information place this part number in a search engine and download
2CSC400002D0208

System ProM compact

Type SN200 Series - Single pole & Switched Neutral



2

		Product Hierarchy 2400002	
Type C 6kA	Single Pole + Switched Neutral	Order Code	Price
2	SN201C2	2CSS255101R0024	16.68
4	SN201C4	2CSS255101R0044	16.68
6	SN201C6	2CSS255101R0064	16.68
10	SN201C10	2CSS255101R0104	16.68
16	SN201C16	2CSS255101R0164	16.68
20	SN201C20	2CSS255101R0204	16.68
25	SN201C25	2CSS255101R0254	16.68
40	SN201C40	2CSS255101R0404	16.68
32	SN201C32	2CSS255101R0324	16.68

Type MC 10kA

1	SN201MC1	2CSS275101R0014	13.69
2	SN201MC2	2CSS275101R0024	13.69
4	SN201MC4	2CSS275101R0044	13.69
6	SN201MC6	2CSS275101R0064	13.69



Full range of product and technical information place this part number in a search engine and download
2CSC400002D0208

System ProM compact

Type S800C Series - Type C 25kA



Full range of product and technical information place this part number in a search engine and download
2CSC400002D0208

Type C 25kA		Product Hierarchy 2400003	
		Order Code	Price
	Single Pole		
10	S801CC10	2CCS881001R0104	26.11
16	S801CC16	2CCS881001R0164	26.11
20	S801CC20	2CCS881001R0204	26.11
25	S801CC25	2CCS881001R0254	26.11
32	S801CC32	2CCS881001R0324	26.11
40	S801CC40	2CCS881001R0404	29.14
50	S801CC50	2CCS881001R0504	29.14
63	S801CC63	2CCS881001R0634	29.14
80	S801CC80	2CCS881001R0804	30.90
100	S801CC100	2CCS881001R0824	30.90
125	S801CC125	2CCS881001R0844	37.20

Type C 25kA		Product Hierarchy 2400003	
		Order Code	Price
	Triple Pole		
10	S803CC10	2CCS883001R0104	76.26
16	S803CC16	2CCS883001R0164	76.26
20	S803CC20	2CCS883001R0204	76.26
25	S803CC25	2CCS883001R0254	76.26
32	S803CC32	2CCS883001R0324	76.26
40	S803CC40	2CCS883001R0404	85.28
50	S803CC50	2CCS883001R0504	85.28
63	S803CC63	2CCS883001R0634	85.28
80	S803CC80	2CCS883001R0804	99.28
100	S803CC100	2CCS883001R0824	99.28
125	S803CC125	2CCS883001R0844	103.05

System ProM compact

Type F200 Series - 2 & 4 pole RCCBs

2



2CSC400565F0201

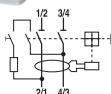

2CSC400569F0201

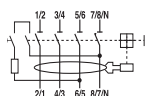

F200 Series RCCBs 2 Pole

AC - BS/EN 61008

Rated Current	Tripping mA	Part No	Product Hierarchy 2500001	
			Order Code	Price
25	30	F202 AC-25/0.03	2CSF202001R1250	57.90
40	30	F202 AC-40/0.03	2CSF202001R1400	61.13
63	30	F202 AC-63/0.03	2CSF202001R1630	73.58
80	30	F202 AC-80/0.03	2CSF202001R1800	91.04
100	30	F202 AC-100/0.03	2CSF202001R1900	106.78
25	300	F202 AC-25/0.3	2CSF202001R3250	54.19
40	300	F202 AC-40/0.3	2CSF202001R3400	55.28
63	300	F202 AC-63/0.3	2CSF202001R3630	62.11

F200 Series RCCBs 4 Pole

AC - BS/EN 61008

25	30	F204 AC-25/0.03	2CSF204001R1250	61.40
40	30	F204 AC-40/0.03	2CSF204001R1400	74.68
63	30	F204 AC-63/0.03	2CSF204001R1630	105.91
80	30	F204 AC-80/0.03	2CSF204001R1800	131.74
100	30	F204 AC-100/0.03	2CSF204001R1900	148.24
100	100	F204 AC-100/0.1	2CSF204001R2900	148.24
25	300	F204 AC-25/0.3	2CSF204001R3250	60.17
40	300	F204 AC-40/0.3	2CSF204001R3400	62.44
63	300	F204 AC-63/0.3	2CSF204001R3630	69.59
100	300	F204 AC-100/0.3	2CSF204001R3900	148.24



Full range of product and technical information place this part number in a search engine and download

2CSC400002D0208

System ProM compact

Type DDA 200 Series - 2 & 4 pole RCD Block



2CSC400163F0201

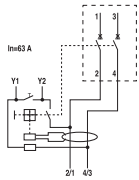

DDA 200 AC type

Function: RCD-block for assembly on site with MCBs S 200 series. Protection against the effects of sinusoidal alternating earth fault currents; protection against indirect contacts and additional protection against direct (with $I_{\Delta n}=30$ mA) contacts.

Application: residential, commercial, industrial.

Standard: IEC/EN 61009 Ann. G

Rated Current In A: 63A

DDA 200 AC type

Product Hierarchy 2500001

Rated Current	Tripping mA	Number of poles	Part No	Order Code	Price
63	30	2	DDA202AC-63/0.03	2CSB202001R1630	62.38
63	300	2	DDA202AC-63/0.3	2CSB202001R3630	65.33
63	300	4	DDA204AC-63/0.3	2CSB204001R1630	82.39



Full range of product and technical information place this part number in a search engine and download
2CSC400002D0208



System ProM compact

DS271 & DS201 Series RCBOs

2



DS 271 AC type, B and C characteristics

Function: protection against overload and short-circuit currents; protection against the effects of sinusoidal alternating earth fault currents; protection against indirect contacts and additional protection against direct contacts ($I_{\Delta n}=30\text{ mA}$); command and isolation of resistive and inductive loads.

Application: residential, commercial, industrial.

Standard: IEC/EN 61009 and BSEN61009-2-2

$I_{cn}=10\text{ kA}$

Current (A)	Sensitivity	Type B - 10kA	Product Hierarchy 2500002	
			Order Code	Price
6	30mA	DS271AC-B6/0.03	2CSR175092R1065	63.27
10	30mA	DS271AC-B10/0.03	2CSR175092R1105	63.27
16	30mA	DS271AC-B16/0.03	2CSR175092R1165	63.27
20	30mA	DS271AC-B20/0.03	2CSR175092R1205	63.27
25	30mA	DS271AC-B25/0.03	2CSR175092R1255	63.27
32	30mA	DS271AC-B32/0.03	2CSR175092R1325	63.27

Current (A)	Sensitivity	Type C - 10kA	Product Hierarchy 2500002	
			Order Code	Price
6	30mA	DS271AC-C6/0.03	2CSR175092R1064	63.27
10	30mA	DS271AC-C10/0.03	2CSR175092R1104	63.27
16	30mA	DS271AC-C16/0.03	2CSR175092R1164	63.27
20	30mA	DS271AC-C20/0.03	2CSR175092R1204	63.27
25	30mA	DS271AC-C25/0.03	2CSR175092R1254	63.27
32	30mA	DS271AC-C32/0.03	2CSR175092R1324	63.27

DS201C RCBOs Single Pole + Switched Neutral

Breaking Cap kA	Rated Current	Tripping mA	Part No	Product Hierarchy 2500001	
				Order Code	Price
6	6	30mA	DS201C6AC30	2CSR255040R1064	70.52
6	10	30mA	DS201C10AC30	2CSR255040R1104	70.52
6	16	30mA	DS201C16AC30	2CSR255040R1164	70.52
6	20	30mA	DS201C20AC30	2CSR255040R1204	70.52
6	25	30mA	DS201C25AC30	2CSR255040R1254	70.52
6	32	30mA	DS201C32AC30	2CSR255040R1324	70.52
6	40	30mA	DS201C40AC30	2CSR255040R1404	70.52

DS201MC RCBOs Single Pole Single Pole + Switched Neutral

10	6	30mA	DS201MC6AC30	2CSR275040R1064	76.20
10	10	30mA	DS201MC10AC30	2CSR275040R1104	76.20
10	16	30mA	DS201MC16AC30	2CSR275040R1164	76.20
10	20	30mA	DS201MC20AC30	2CSR275040R1204	76.20
10	32	30mA	DS201MC32AC30	2CSR275040R1324	76.20



Full range of product and technical information place this part number in a search engine and download
2CSC400002D0208

System ProM compact

S200 Accessories

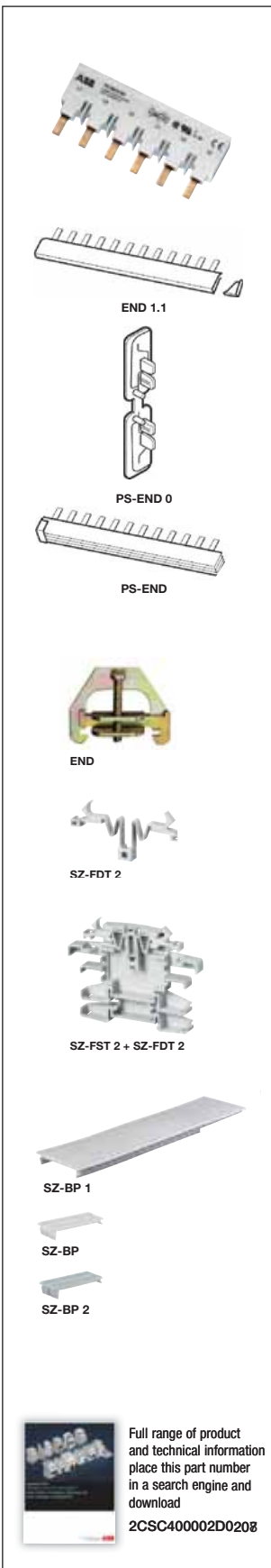

Busbars and Connections

Product Hierarchy 2400002	Part No	Order Code	Price
BS Compact blank labels	BS	GHS2001946R0001	4.39
End end clamp	END	GJI1001814R0001	1.32
KA27H side cut to length term shroud	KA27H	GHS2101933R0001	6.95
KA27S end covers	KA27S	GHS2101934R0001	2.46
PS1/38/16h compact b/bar sp & aux	PS1/38/16H	2CDL210001R1638	14.57
PS1/60/16 compact busbar sp 16mm 60 mod	PS1/60/16	2CDL210001R1660	14.79
PS1-4/16 compact to classic connector	PS1-4/16	2CDL210007R1604	3.64
PS2 compact busbar dp 16mm 58 mod	PS2/58/16	2CDL220001R1658	32.39
PS2/48/16h compact busbar dp & aux	PS2/48/16H	2CDL220001R1648	47.12
PS2/58 compact b/bar dp 10mm 58mod	PS2/58	2CDL220001R1058	32.46
PS3/48/16h compact busbar tp & aux	PS3/48/16H	2CDL230001R1648	41.01
PS3/60/16 compact busbar tp 16mm 60 mod	PS3/60/16	2CDL230001R1660	45.17
PS4/60/16 compact busbar 4p 16mm 60 mod	PS4/60/16	2CDL240001R1660	62.34
PS-END compact busbar end cap 2/3p	PS-END	2CDL200001R0001	0.80
PS-END0 compact busbar end cap 1p	PS-END0	2CDL200001R0004	2.03
PS-END1 compact busbar end cap 4p	PS-END1	2CDL200001R0002	0.80
SZ-AST25I insulated terminal pin 25mm	SZ-AST25I	GHV0360501R0007	1.56
SZ-AST50I insulated terminal pin 50mm	SZ-AST50I	GHV0360501R0009	3.36
SZ-AST55I insulated terminal pin 80mm	SZ-AST55I	2CDL200002R5002	5.21
SZ-AST9I 25mm insulated phase terminal	SZ-AST9I	2CDL200001R2502	4.88
SZ-BSK5 insulated cover for busbar	SZ-BSK5	GHV0360505R0001	1.32
SZ-ESK2	SZ-ESK2	2CDL200001R3501	3.10
SZ-FDT2 spring piece	SZ-FDT2	GHL5301908R0005	0.74
SZ-FST2 filler piece	SZ-FST2	GHL5301908R0002	1.02
SZ-KLB8 terminal bar 1x16	SZ-KLB8	GJI2320131R0001	3.84
SZ-KTR carrier for terminals SZKLB8	SZ-KTR	GJI2024027R0001	0.56

Blanks and Covers

Product Hierarchy 2400002	Part No	Order Code	Price
SZ-BP1 blanking cover	SZ-BP1	GHL5301904R0001	2.08
SZ-BP2 blanking plate 1 module	SZ-BP2	GHS2701913R0002	0.33
SZ-BSK Insulated cover for busbar	SZ-BSK	2CDL200001R0011	1.36

System ProM compact

S200 Accessories

2



Accessories	Part No	Product Hierarchy 2400002	
		Order Code	Price
Compact lower aux 1no	SC2-H10	2CDS200970R0002	11.33
S2C-A1 compact shunt trip 12-60v	S2C-A1	2CDS200909R0001	23.06
S2C-A2 compact shunt trip 110-415v	S2C-A2	2CDS200909R0002	23.06
S2C-DH mcb rotary handle adaptor	S2C-DH	GHS2001901R0003	29.19
S2C-EST compact plug-in base	S2C-EST	2CSS200999R0001	15.13
S2C-H11L compact left aux 1no 1nc	S2C-H11L	2CDS200936R0001	12.51
S2C-H6R compact c/o auxilliary	S2C-H6R	2CDS200912R0001	12.51
S2C-NT compact hand op neutral	S2C-NT	2CDS200918R0001	8.47
S2C-S/H6r compact signal / auxilliary	S2C-S/H6R	2CDS200922R0001	14.89
S2C-UA24ac compact u/v trip 24vac	S2C-UA24	2CSS200911R0002	39.75
SA1 mcb padlock adaptor 3mm	SA1	GJF1101903R0001	2.45
SA1E mcb padlock adaptor 6mm	SA1E	GJF1101903R0004	3.55
SA2 mcb padlock with two keys	SA2	GJF1101903R0002	6.82
S2C Compact Plug-in Base	S2C-EST	2CSS200999R0001	15.13



Full range of product and technical information place this part number in a search engine and download
2CSC400002D0208

System ProM compact

Digital Energy Meters



DCB13000

Digital Meters

Description	Part No	Product Hierarchy 2700001	
		Order Code	Price
ODIN Single Phase, Direct Connected	OD1065	2CMA131040R1000	81.00
ODIN Single Phase, Pulse Output, Direct Connected	OD1365	2CMA131041R1000	90.00
DELTA Single Phase - 2 Tariff with Pulse Output	FBB11205	2CMA180894R1000	111.00
DELTA Single Phase - 2 Tariff	FBU11205	2CMA180893R1000	105.00
ODIN 3 Phase + N - 1 Pulse Output, Direct Connected	OD4165	2CMA131024R1000	162.00
ODIN 3 Phase + N - 1 Pulse Output, CT Connected	OD4110	2CMA131025R1000	162.00
DELTA Plus 3 phase + N - 1 Tariff with Pulse Output	DAB13000	2CMA180806R1000	204.00
DELTA Max 3 phase + N - 2 Tariff with Internal Clock and THD	DEB13005	2CMA139495R1000	267.00
DELTA Max 3 phase + N - 2 Tariff with Time Dependant Functions and THD	DEB13007	2CMA139497R1000	249.00

Communication Adaptors

Description	Part No	Product Hierarchy 2700001	
		Order Code	Price
LON PLC A-Band Adaptor	CAL 06000	2CMA137100R1000	161.09
Ethernet Adaptor	CEM 05100	2CMA137121R1000	129.00
M-bus (Meter Bus) Adaptor	CTM 04000	2CMA137090R1000	114.00
LON PLC C-Band Adaptor	CCL 06000	2CMA137103R1000	161.09
RS232 Adaptor	CRM04000	2CMA137091R1000	114.00



Full range of product and technical information place this part number in a search engine and download

2CSC400002D0208

System ProM compact

Modular Devices



Full range of product and technical information place this part number in a search engine and download
2CSC400002D0208

Product Hierarchy 2700001

Timers

	Order Code	Price
Analogue AT3-7R timer 7 day c/w reserve	2CSM204245R0601	75.60
Analogue AT3-R daily timer with reserve	2CSM204235R0601	77.25
Digital DT1 1 channel weekly time switch	2CSM204255R0611	100.60

Isolators

E202/100R 2P 100A	2CDE282001R0100	18.69
E202/125R 2P 125A	2CDE282001R0125	35.96
E202/63R 2P 63A	2CDE282001R0063	20.96
E203/100R 3P 100A	2CDE283001R0100	37.03
E203/125R 3P 125A	2CDE283001R0125	53.46
E204/125R 4P 125A	2CDE284001R0125	67.39
E204/63R 4P 63A	2CDE284001R0063	40.03

Contactors

EH04-20 ESB Aux 2no	GHE3401321R0001	14.10
ESB20-02 Contactor 2nc 24V	GHE3211202R0001	21.55
ESB24-04 Contactor 4no 24V	GHE3291202R0001	31.16
ESB-DIS Distance Piece	GHE3201902R0001	0.96

Fuseholders

E91/32 SP Fuseholder 32A 10.3x38	2CSM200923R1801	2.77
E931/125 E931/125A Fuse Carrier	2CSM371710R1801	2.77

Toroidal Transformers

TR2 60mm	2CSG060100R1211	87.05
TR3 80mm	2CSG080100R1211	103.69
TR4 110mm	2CSG110100R1211	120.13

Twilight Switch

TW1	2CSM204135R1341	45.61
-----	-----------------	-------

Product Hierarchy 6000002

Surge Suppressors

	Order Code	Price
OVR T1 3N 255 25TS Type1 3P&N	2CTB815101R0700	730.22
OVR T2 3N 40 275 SPTS Type 2 3P&N	2CTB803953R0200	185.70



Tmax Moulded Case Circuit Breakers

Tmax T1 ... T7.....	60 - 67
Tmax Non Automatic.....	68
Tmax Accessories	69 - 72



Emax Air Circuit Breakers

Emax X1 E1 ...E3	73
Emax Non Automatic	74
Emax Accessories	75



MCCBs



Full range of product and technical information place this part number in a search engine and download
1SDC210015D0204

ACBs



Full range of product and technical information place this part number in a search engine and download
1SDC200009D0203

Power Distribution Circuit Breakers

Tmax T1



Ratings @ 400V

	Icu	Ics
T1B	25kA	100%
T1C	25kA	100%
T1N	36kA	75%

Protection types available

Type	Settings	
	Ith	Im
Standard Distribution (3&4 pole)	70-100%	10xIth (*)

*Subject to a minimum value of 630A

Fixed Pattern Circuit Breaker

Supplied as standard with front bar terminals for busbar - for other terminals see accessories section

Thermomagnetic

Model	Current [A]	
	Ith/In	Im
T1B	T1B160R16	16A
	T1B160R20	20A
	T1B160R32	32A
	T1B160R40	40A
	T1B160R50	50A
	T1B160R63	63A
	T1B160R80	80A
	T1B160R100	100A
	T1B160R125	125A
T1B160R160	160A	

T1C	T1C160R25	25A
	T1C160R32	32A
	T1C160R40	40A
	T1C160R50	50A
	T1C160R63	63A
	T1C160R80	80A
	T1C160R100	100A
	T1C160R125	125A
	T1C160R160	160A

T1N	T1N160R32	32A
	T1N160R40	40A
	T1N160R50	50A
	T1N160R63	63A
	T1N160R80	80A
	T1N160R100	100A
	T1N160R125	125A
	T1N160R160	160A

Product Hierarchy 3000004								
1 Pole		Price	3 Pole		Price	4 Pole		Price
1SDA052616R1	64.45	1SDA050870R1	92.35	-	POA			
1SDA052617R1	64.45	1SDA050871R1	92.35	-	POA			
1SDA052619R1	64.45	1SDA050873R1	92.35	1SDA050884R1	120.06			
1SDA052620R1	64.45	1SDA050874R1	92.35	-	POA			
-	-	1SDA050875R1	92.35	-	POA			
1SDA052622R1	64.45	1SDA050876R1	92.35	1SDA050887R1	120.06			
1SDA052623R1	64.45	1SDA050877R1	94.87	1SDA050888R1	123.30			
1SDA052624R1	64.45	1SDA050878R1	94.87	1SDA050889R1	123.30			
1SDA052625R1	71.12	1SDA050879R1	97.13	1SDA050890R1	126.29			
1SDA052626R1	77.98	1SDA050880R1	129.62	1SDA050936R1	168.51			

-	POA	1SDA050894R1	125.35	-	POA
-	POA	1SDA050895R1	125.35	-	POA
-	POA	1SDA050896R1	125.35	-	POA
-	POA	1SDA050897R1	125.35	-	POA
-	POA	1SDA050898R1	125.35	-	POA
-	POA	1SDA050899R1	129.42	1SDA050910R1	174.70
-	POA	1SDA050900R1	129.42	1SDA050911R1	174.70
-	POA	1SDA050901R1	137.53	1SDA050912R1	180.23
-	POA	1SDA050902R1	168.83	1SDA050937R1	221.58

-	POA	1SDA050917R1	137.74	1SDA050928R1	185.62
-	POA	1SDA050918R1	137.74	-	POA
-	POA	1SDA050919R1	137.74	-	POA
-	POA	1SDA050920R1	137.74	1SDA050931R1	185.62
-	POA	1SDA050921R1	140.54	-	POA
-	POA	1SDA050922R1	140.54	1SDA050933R1	208.94
-	POA	1SDA050923R1	151.12	1SDA050934R1	224.65
-	POA	1SDA050924R1	195.28	1SDA050938R1	273.75

POA Price on Application please consult us



Full range of product and technical information place this part number in a search engine and download
1SDC210015D0204

Power Distribution Circuit Breakers

Tmax T2



Ratings @ 400V

	Icu	Ics
T2N	36kA	100%
T2S	50kA	100%
T2H	70kA	100%
T2L	85kA	75%

Fixed Pattern Circuit Breaker

Supplied as standard with front bar terminals for busbar - for other terminals see accessories section

Thermomagnetic

Model	Current [A]	
	Ith/In	Im
T2N	T2N160R16	16A
	T2N160R20	20A
	T2N160R32	25A
	T2N160R32	32A
	T2N160R40	40A
	T2N160R50	50A
	T2N160R63	63A
	T2N160R80	80A
	T2N160R100	100A
	T2N160R125	125A
T2N160R160	160A	

T2S	T2S160R16	16A
	T2S160R20	20A
	T2S160R32	32A
	T2S160R40	40A
	T2S160R50	50A
	T2S160R63	63A
	T2S160R80	80A
	T2S160R100	100A
	T2S160R125	125A
	T2S160R160	160A

T2H	T2H160R32	32A
	T2H160R80	80A
	T2H160R100	100A
	T2H160R160	160A

Product Hierarchy 3000004			
3 Pole	Price	4 Pole	Price
1SDA050950R1	163.51	-	POA
1SDA050951R1	163.51	1SDA050973R1	206.54
1SDA050952R1	163.51	-	POA
1SDA050953R1	163.51	1SDA050975R1	206.54
1SDA050954R1	163.51	-	POA
1SDA050955R1	163.51	-	POA
1SDA050956R1	163.51	1SDA050978R1	206.54
1SDA050957R1	163.51	1SDA050979R1	220.76
1SDA050958R1	163.51	1SDA050980R1	220.76
1SDA050959R1	166.81	1SDA051115R1	238.66
1SDA050960R1	215.56	1SDA051116R1	283.81
1SDA050994R1	165.77	-	POA
1SDA050995R1	165.77	-	POA
1SDA050997R1	165.77	1SDA051019R1	210.15
1SDA050998R1	165.77	-	POA
-	-	-	POA
1SDA051000R1	165.77	1SDA051022R1	210.15
1SDA051001R1	169.32	-	POA
1SDA051002R1	169.32	1SDA051024R1	222.38
1SDA051003R1	180.91	-	POA
1SDA051004R1	214.34	-	POA
1SDA051041R1	168.91	-	POA
1SDA051045R1	172.50	-	POA
1SDA051046R1	172.50	-	POA
1SDA051048R1	282.08	-	POA

POA Price on Application please consult us



Full range of product and technical information place this part number in a search engine and download
1SDC210015D0204

Power Distribution Circuit Breakers

Tmax T2



Ratings @ 400V

	Icu	Ics
T2N	36kA	100%
T2S	50kA	100%
T2H	70kA	100%
T2L	85kA	75%

Fixed Pattern Circuit Breaker

Supplied as standard with front bar terminals for busbar - for other terminals see accessories section

Thermomagnetic

Model	Current [A]
T2N	T2N160MA32
	T2N160MA52
	T2N160MA80
	T2N160MA100

Product Hierarchy 3000004			
3 Pole	Price	4 Pole	Price
1SDA051208R1	134.63	-	POA
1SDA051209R1	134.63	-	POA
1SDA051210R1	134.63	-	POA
1SDA051211R1	134.63	-	POA

T2S	T2S160MA32
------------	------------

1SDA051217R1	136.93	-	POA
--------------	--------	---	-----

T2H	T2H160MA52
------------	------------

1SDA051226R1	138.67	-	POA
--------------	--------	---	-----

PR221DS/LS

Model	Current [A]	
	Ith/In	Im
T2N	T2N160R63	63A
	T2N160R100	100A
	T2N160R160	160A

Product Hierarchy 3000004			
3 Pole	Price	4 Pole	Price
-	POA	1SDA051130R1	287.69
1SDA051126R1	221.31	-	POA
1SDA051127R1	300.08	-	POA

T2S	T2S160R100	100A
	T2S160R160	160A

1SDA051136R1	238.24	-	POA
1SDA051137R1	321.51	-	POA

T2L	T2L160R160	160A
------------	------------	------

1SDA051157R1	526.88	-	POA
--------------	--------	---	-----

POA Price on Application please consult us



Full range of product and technical information place this part number in a search engine and download

1SDC210015D0204

Power Distribution Circuit Breakers

Tmax T3



Ratings @ 400V

	Icu	Ics
T3N	36kA	75%
T3S	50kA	50%

Fixed Pattern Circuit Breaker

Supplied as standard with front bar terminals for busbar - for other terminals see accessories section

Thermomagnetic

Model	Current [A]		Product Hierarchy 3000004			
	Ith/In	Im	3 Pole	Price	4 Pole	Price
T3N	T3N250R63	63A	1SDA051241R1	186.57	-	POA
	T3N250R100	100A	1SDA051243R1	186.57	-	POA
	T3N250R125	125A	1SDA051244R1	205.76	-	POA
	T3N250R160	160A	1SDA051245R1	262.00	1SDA051304R1	379.96
	T3N250R200	200A	1SDA051246R1	262.00	1SDA051305R1	379.96
	T3N250R250	250A	1SDA051247R1	361.99	1SDA051306R1	483.38
T3S	T3S250R63	63A	1SDA051263R1	205.23	-	POA
	T3S250R100	100A	1SDA051265R1	205.23	-	POA
	T3S250R125	125A	1SDA051266R1	226.37	-	POA
	T3S250R160	160A	-	POA	-	POA
	T3S250R200	200A	1SDA051268R1	288.20	-	POA
	T3S250R250	250A	1SDA051269R1	398.19	1SDA051310R1	531.72

Magnetic Only

Model	Current [A]	Product Hierarchy 3000004			
		3 Pole	Price	4 Pole	Price
T3N	T3N250MA200	1SDA051318R1	288.20	-	POA

POA Price on Application please consult us



Full range of product and technical information place this part number in a search engine and download
1SDC210015D0204

Power Distribution Circuit Breakers

Tmax T4



Ratings @ 400V

	Icu	Ics
T4N	36kA	100%
T4S	50kA	100%
T4H	70kA	100%

Fixed Pattern Circuit Breaker

Supplied as standard with front bar terminals for busbar - for other terminals see accessories section

Thermomagnetic

Model	Current [A]	
	Ith/In	Im
T4N	200	1000...2000
T4S	250	1250...2500
T4H	200	1000...2000
	250	1250...2500

Product Hierarchy 3000006

3 pole		Price	4 pole		Price
1SDA054214R1		355.61	-		POA
1SDA054179R1		373.18	-		POA
1SDA054214R1		355.61	-		POA
1SDA054215R1		460.93	-		POA

Magnetic Only

Model	Current [A]
T4N	T4N250MA200

Product Hierarchy 3000006

3 Pole		Price	4 Pole		Price
1SDA054300R1		270.11	-		POA

PR221DS/LS

Model	Current [A]	
	Ith/In	Im
T4N	T4N250R250	250A
	T4N320R320	320A
T4S	T4S250R100	100A
	T4S250R250	250A

Product Hierarchy 3000006

3 Pole		Price	4 Pole		Price
1SDA053999R1		431.82	1SDA054011R1		574.01
1SDA054117R1		464.08	1SDA054121R1		611.02
1SDA054021R1		319.28	-		POA
1SDA054023R1		501.39	1SDA054035R1		631.41

POA Price on Application please consult us



Full range of product and technical information place this part number in a search engine and download

1SDC210015D0204

Power Distribution Circuit Breakers

Tmax T5



Ratings @ 400V

	Icu	Ics
T5N	36kA	100%
T5S	50kA	100%
T5H	70kA	100%

Fixed Pattern Circuit Breaker

Supplied as standard with front bar terminals for busbar - for other terminals see accessories section

Thermomagnetic

Model	Current [A]	
	Ith/In	Im
T5N	320	1600...3200
	400	2000...4000
	500	2500...5000

T5S	400	2000...4000
-----	-----	-------------

T5H	400	2000...4000
-----	-----	-------------

Product Hierarchy 3000006

3 pole		Price	4 pole		Price
1SDA054436R1		483.50	1SDA054477R1		642.12
1SDA054437R1		483.50	1SDA054478R1		642.14
1SDA054456R1		711.83	1SDA054487R1		919.98

1SDA054441R1	531.84	-	POA
--------------	--------	---	-----

1SDA054445R1	571.45	-	POA
--------------	--------	---	-----

PR221DS/LS

Model	Current [A]	
	Ith/In	Im
T5N	T5N400R400	400A
	T5N630R630	630A

T5S	T5S400R400	400A
	T5S630R630	630A

T5H	T5S400R400	400A
	T5S630R630	630A

Product Hierarchy 3000006

3 Pole		Price	4 Pole		Price
1SDA054317R1		514.44	1SDA054325R1		684.85
1SDA054396R1		819.37	1SDA054400R1		1073.72

1SDA054333R1	565.87	-	POA
1SDA054405R1	901.31	-	POA

1SDA054349R1	573.96	-	POA
1SDA054412R1	913.83	-	POA

PR222DS/LS

Model	Current [A]	
	Ith/In	Im
T5N	T5N630R630	630A

Product Hierarchy 3000006

3 Pole		Price	4 Pole		Price
-		-	1SDA054402R1		1216.53

POA Price on Application please consult us



Full range of product and technical information place this part number in a search engine and download
1SDC210015D0204

Power Distribution Circuit Breakers

Tmax T6



Ratings @ 400V

	Icu	Ics
T6N	36kA	100%
T6S	50kA	100%
T6H	70kA	100%
T6L	100kA	100%

Fixed Pattern Circuit Breaker

Supplied as standard with front bar terminals for busbar - for other terminals see accessories section

Thermomagnetic

Model	Current [A]	
	Ith/In	Im
T6N	630	3150...6300
	800	4000...8000
T6S	800	4000...8000

Product Hierarchy 3000006					
3 pole		Price	4 pole		Price
1SDA060202R1		738.79	1SDA060210R1		954.41
1SDA060214R1		952.51	-		POA
1SDA060216R1		998.31	1SDA060222R1		1214.57

PR221DS/LS

Model	Current [A]	
	Ith/In	Im
T6N	T6N630R630	630A
	T6N800R630	800A
	T6N1000R1000	1000A
T6S	T6S630R630	630A
	T6S800R630	800A

Product Hierarchy 3000006					
3 Pole		Price	4 Pole		Price
1SDA060226R1		776.07	1SDA060231R1		996.36
1SDA060268R1		990.73	1SDA060273R1		1257.43
1SDA060537R1		1256.35	1SDA060542R1		1409.04
-		POA	1SDA060241R1		1117.81
1SDA060278R1		1036.53	1SDA060283R1		1301.05

POA Price on Application please consult us



Full range of product and technical information place this part number in a search engine and download

1SDC210015D0204

Power Distribution Circuit Breakers

Tmax T7



Ratings @ 400V

	Icu	Ics
T7S	50kA	100%
T7H	70kA	100%
T7L	120kA	100%
T7V	150kA	100%

Fixed Pattern Circuit Breaker

Supplied as standard with front bar terminals for busbar - for other terminals see accessories section

PR231LS/I

Model	Current [A]	
	Ith/In	Im
*T7S Lever	T7S800	800A
	T7S1000	1000A
	T7S1250	1250A
	T7S1250	1600A

T7S Push Button	T7S800M	800A
	T7S1000M	1000A
	T7S1250M	1250A
	T7S1250M	1600A

Product Hierarchy 3000006			
3 Pole	Price	4 Pole	Price
1SDA061963R1	1091.48	1SDA061973R1	1306.46
1SDA062738R1	1232.44	1SDA062746R1	1577.93
1SDA062866R1	1502.19	1SDA062874R1	1869.97
1SDA062994R1	2116.95	1SDA063002R1	2495.31
1SDA061981R1	1200.64	1SDA061989R1	1437.11
1SDA062754R1	1356.23	1SDA062762R1	1735.73
1SDA062882R1	1652.40	1SDA062890R1	2056.97
1SDA063010R1	2328.65	1SDA063018R1	2744.83

*Please note: It is not possible to motorise this breaker

POA Price on Application please consult us



Full range of product and technical information place this part number in a search engine and download
1SDC210015D0204

Power Distribution Circuit Breakers

Tmax Switch Disconnectors

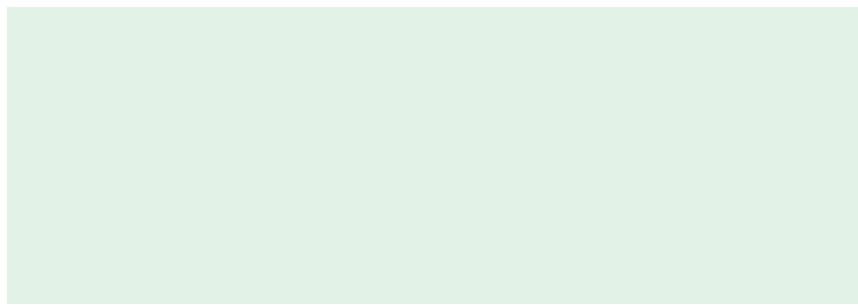

Non Automatic		
lcw	Model	Current [A] lu
2kA	T1D 160 F FC Cu	160
3.6kA	T3D 250 F F	250

Product Hierarchy 3000006							
3 pole		Price		4 pole		Price	
1SDA051325R1		123.54		1SDA051326R1		160.91	
1SDA051327R1		198.81		1SDA051328R1		257.46	

Non Automatic		
lcw	Model	Current [A] lu
3.6kA	T4D 250 F F	250
	T4D 320 F F	320
6kA	T5D 400 F F	400
	T5D 630 F F	630

Product Hierarchy 3000006							
3 pole		Price		4 pole		Price	
-		POA		-		POA	
-		POA		1SDA054598R1		552.93	
1SDA054599R1		440.51		1SDA054600R1		628.59	
1SDA054601R1		628.59		1SDA054602R1		876.17	

15kA	T6D 630 F F	630
	T6D 800 F F	1000
	T6D 1000 F F	1250

1SDA060343R1		599.57		-		POA	
1SDA060345R1		929.19		-		POA	
-		POA		-		POA	

25kA	T7D 1000 F F	1000
	T7D 1250 F F	1250
	T7D 1600 F F	1600
	T7D 1000 M F F	1000
	T7D 1250 M F F	1250
	T7D 1600 M F F	1600

-		POA		1SDA062039R1		1583.83	
-		POA		1SDA062041R1		1683.10	
-		POA		-		POA	
-		POA		-		POA	
-		POA		1SDA062043R1		1851.43	

POA Price on Application please consult us



Full range of product and technical information place this part number in a search engine and download

1SDC210015D0204

Power Distribution Circuit Breakers

T1 ... T7 Accessories

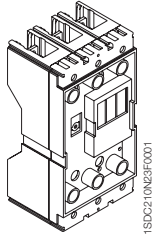

1SDC210N25F001

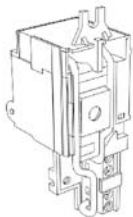
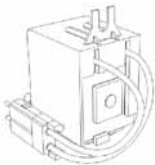
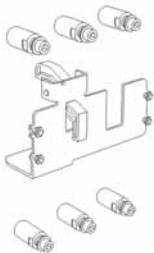
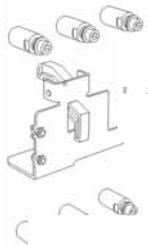

Full range of product and technical information place this part number in a search engine and download
1SDC210015D0204

Plug-in (P) - Fixed Part

	Product Hierarchy 3000006			
	Order Code	Price	Order Code	Price
F = Front terminals	3 pole		4 pole	
T2 circuit breaker in plug-in version In max = 144A	1SDA051329R1	49.48	1SDA051330R1	64.90
T3 circuit breaker in plug-in version In max = 225A	1SDA051331R1	78.51	1SDA051332R1	103.01

EF = Extended front terminals	3 pole	Price	4 pole	Price
T4	1SDA054737R1	95.59	1SDA054740R1	124.29
T5 400	1SDA054749R1	192.55	1SDA054752R1	250.32
T5 630 circuit breaker in plug-in version In max = 570A	1SDA054762R1	205.21	-	POA

HR = Rear flat horizontal terminals	3 pole	Price	4 pole	Price
	1SDA054739R1	117.68	-	POA

Withdrawable (W) - Fixed Part

	Product Hierarchy 3000006			
	Order Code	Price	Order Code	Price
F = Front terminals	3 pole		4 pole	
T6	1SDA060384R1	280.01	1SDA060387R1	363.98

HR = Rear flat horizontal terminals	3 pole	Price	4 pole	Price
T6	-	POA	1SDA060388R1	507.45

Note: Fixed parts on T7 - T7M circuit breakers with **** terminals are supplied as standard with terminals mounted in horizontal. To order the terminals mounted vertically, use the extra code 1SDA063521R1

Conversion of the version

	Product Hierarchy 3000006			
	Order Code	Price	Order Code	Price
T2...T5 Fixed to moving part of plug-in	3 pole		4 pole	
Kit P MP T2	1SDA051411R1	32.99	1SDA051412R1	43.26
Kit P MP T3	1SDA051413R1	39.26	-	POA
Kit P MP T4	1SDA054839R1	41.16	1SDA054840R1	53.97
Kit P MP T5 400	1SDA054843R1	56.04	1SDA054844R1	72.87
Kit P MP T5 630	1SDA054847R1	80.06	-	POA

T4...T7 Fixed to moving part of withdrawable	3 pole	Price	4 pole	Price
Kit P MP T4	1SDA054841R1	68.28	-	-
Kit P MP T6	1SDA060390R1	96.92	1SDA060391R1	126.00

Shunt Opening Releases - SOR

	Product Hierarchy 3000006			
	Order Code	Price	Order Code	Price
Cabled version	3 pole		4 pole	
SOR-C 12V DC	1SDA053001R1	45.58	-	POA
SOR-C 24...30V AC/DC	1SDA051339R1	45.58	1SDA054870R1	49.01
SOR-C 110...127V AC - 110...125V DC	1SDA051341R1	45.58	1SDA054872R1	49.01
SOR-C 220...240V AC - 220...250V DC	1SDA051342R1	45.58	1SDA054873R1	49.01
SOR-C 380...440V AC	1SDA051343R1	45.58	-	POA

POA Price on Application please consult us

Power Distribution Circuit Breakers

T1 ... T7 Accessories

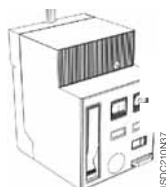
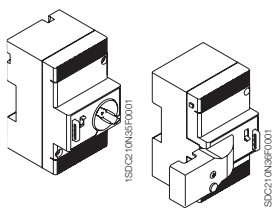
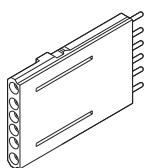
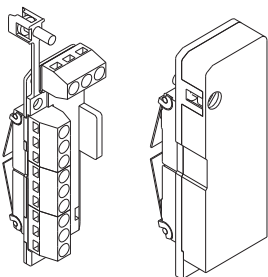
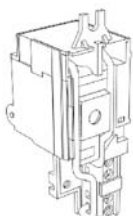
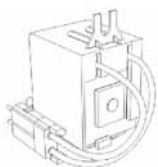

Full range of product and technical information place this part number in a search engine and download
1SDC210015D0204

Undervoltage Releases - UVR

	Product Hierarchy 3000006			
	Order Code	Price	Order Code	Price
Cabled version	T1-T2-T3		T1-T2-T3	
UVR-C 24...30V AC/DC	1SDA051351R1	71.25	1SDA054887R1	69.27
UVR-C 110...127V AC - 110...125V DC	1SDA051353R1	71.25	1SDA054890R1	69.27
UVR-C 240...250V AC/DC	1SDA051354R1	71.25	1SDA054891R1	69.27
UVR-C 380...440V AC	-	POA	1SDA054892R1	69.27

Auxiliary Contacts - AUX

	Product Hierarchy 3000006			
	Order Code	Price	Order Code	Price
Cabled version with 1m cables	T1-T2-T3		T4-T5-T6	
AUX-C 1Q 1SY 250AC/DC	1SDA051370R1	30.03	1SDA054910R1	29.43
AUX-C 3Q 1SY 250AC/DC	1SDA051371R1	60.06	1SDA054911R1	58.84
AUX-C 3Q 1SY 250AC/DC	1SDA051354R1		1SDA054913R1	29.43
Cabled version T2 with PR221 DS trip	T2		T4-T5	
AUX-C 1 S51 1Q SY	1SDA053704R1	18.33	-	POA
Cabled contact, signalling trip coil release trip			T1-T2-T3	
AUX-SA 1 S51 T4-T5			1SDA055050R1	28.84
Cabled version with 1m cables			T7-T7M	
AUX-C 1Q 1SY 400AC			1SDA062104R1	25.66
Cabled contact, signalling trip coil release trip			T7-T7M	
AUX-SA 1 S51 T7M			1SDA062105R1	49.11

Adapters - ADP

Type	Product Hierarchy 3000006	
	Order Code	Price
	T4-T5-T6	
ADP - Adapter 5 pin	1SDA055173R1	7.23
ADP - Adapter 6 pin	1SDA054922R1	7.23
ADP - Adapter 12 pin	1SDA054923R1	10.33
ADP - Adapter 10 pin	1SDA054924R1	9.27

Motor Operator

	Product Hierarchy 3000006			
	Order Code	Price	Order Code	Price
Solenoid operator - MOS	T4-T5-T6			
ADP - Adapter 5 pin	1SDA055173R1	7.23		
Stored energy motor operator - MOE	T4-T5		T6	
MOE T4-T5 24V DC	1SDA054894R1	479.11	1SDA060395R1	569.34
MOE T4-T5 110...125V AC/DC	1SDA054896R1	479.11	-	POA
MOE T4-T5 220...250V AC/DC	1SDA054897R1	479.11	1SDA060398R1	569.34

POA Price on Application please consult us

Power Distribution Circuit Breakers

T1 ... T7 Accessories

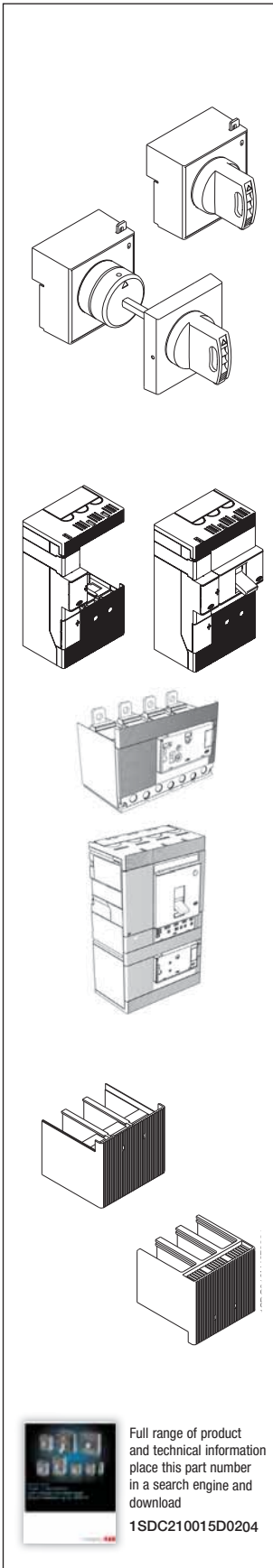

Full range of product and technical information place this part number in a search engine and download
1SDC210015D0204

Rotary handle operating mechanism

	Product Hierarchy 3000006			
	Order Code	Price	Order Code	Price
Direct - RHD	T1-T2-T3		T4-T5	
RHD normal for fixed & plug-in	1SDA051381R1	33.49	1SDA054926R1	52.53
RHD normal for withdrawable	-	POA	1SDA054928R1	51.52
Direct - RHD	T6		T7	
RHD normal for withdrawable	1SDA060405R1	55.64	1SDA062120R1	124.29
Door mounted rotary handle - RHE	T1-T2-T3		T4-T5	
RHE normal for fixed & plug-in	1SDA051383R1	47.82	1SDA054929R1	66.46
RHE-EM emergency for fixed & plug-in	1SDA051384R1	50.21	1SDA054930R1	81.29
RHE normal for withdrawable	-	POA	1SDA054933R1	66.44
Door mounted rotary handle - RHE	T6		T7	
RHE normal for fixed & plug-in	1SDA060409R1	83.72	1SDA062122R1	91.43
RHE normal for withdrawable	1SDA060411R1	83.72	1SDA062122R1	91.43
Individual Components	T1-T2-T3		T4-T5	
RHE-B just base for RHE for fixed & plug-in	1SDA051385R1	22.62	-	POA
RHE-S just rod 500mm for RHE	1SDA051386R1	7.55	-	POA
RHE-S just handle for RHE	1SDA051387R1	20.09	-	POA
IP54 protection for rotary handle	T1-T2-T3		T4-T5	
RHE-IP54 protection kit	1SDA051392R1	17.55	1SDA054938R1	25.77

Residual current releases

	Product Hierarchy 3000006			
	Order Code	Price	Order Code	Price
RC221, RC222, RC223	3 pole		4 pole	
R221/1 per T1	-	POA	1SDA051401R1	262.88
R222/1 per T1	1SDA051400R1	286.03	1SDA051402R1	314.65
R221/3 per T3	-	POA	1SDA051409R1	393.31
R222/3 per T3	-	POA	1SDA051410R1	578.37
R222/4 per T4	-	POA	1SDA054954R1	594.66
R222/5 per T5	-	POA	1SDA054955R1	731.45

Connection terminals

	Product Hierarchy 3000006			
	Order Code	Price	Order Code	Price
Type	3 pole		4 pole	
HTC T1	1SDA051415R1	10.66	1SDA051416R1	13.86
HTC T2	1SDA051417R1	12.20	1SDA051418R1	15.86
HTC T3	1SDA051419R1	15.25	1SDA051420R1	19.82
HTC T4	1SDA054958R1	17.26	1SDA054959R1	22.43
HTC T5	1SDA054960R1	21.57	1SDA054961R1	28.06
HTC T7 - T7M	1SDA063091R1	23.94	1SDA063092R1	30.47

POA Price on Application please consult us

Power Distribution Circuit Breakers

T1 ... T7 Accessories



Low insulating terminals covers - HTC

Product Hierarchy 3000006

Type	3 pole		4 pole	
	Order Code	Price	Order Code	Price
LTC T1	1SDA051421R1	8.96	1SDA051422R1	11.67
LTC T2	1SDA051423R1	10.25	1SDA051424R1	13.34
LTC T3	1SDA051425R1	12.82	1SDA051426R1	16.69
LTC T4	1SDA054966R1	13.71	-	POA
LTC T5	1SDA054968R1	17.11	-	POA

Front extended terminals - EF

Product Hierarchy 3000006

Type	3 pieces		4 pieces		6 pieces		8 pieces	
	Order Code	Price	Order Code	Price	Order Code	Price	Order Code	Price
EF T1	1SDA051442R1	11.00	1SDA051443R1	14.72	1SDA051440R1	21.99	-	POA
EF T2	1SDA051466R1	12.56	1SDA051467R1	16.83	1SDA051464R1	25.11	-	POA
EF T3	1SDA051490R1	15.70	-	POA	1SDA051488R1	31.39	-	POA
EF T4	-	-	-	POA	1SDA054998R1	32.91	-	POA
EF T5	1SDA055036R1	21.32	1SDA055037R1	27.71	1SDA055034R1	42.64	1SDA055035R1	55.42
EF T6 630	1SDA023379R1	21.04	-	POA	1SDA013920R1	42.10	-	POA
EF T6 800	1SDA023383R1	23.84	1SDA023393R1	30.99	1SDA013954R1	47.71	-	POA
EF T7-T7M	1SDA063103R1	53.76	-	POA	1SDA063105R1	107.59	1SDA063106R1	139.86

Front terminals for copper-aluminium cables - FC CuAl

Product Hierarchy 3000006

Type	3 pieces		4 pieces		8 pieces	
	Order Code	Price	Order Code	Price	Order Code	Price
FC CuAl T1 95mm ²	1SDA051446R1	22.87	1SDA051447R1	30.62	1SDA51445R1	56.19
FC CuAl T2 95mm ²	1SDA051458R1	11.86	-	POA	-	POA
FC CuAl T7 4x240mm ²	1SDA063112R1	102.99	-	POA	-	POA

Front extended spread terminals - ES

Product Hierarchy 3000006

Type	3 pieces		4 pieces		6 pieces		8 pieces	
	Order Code	Price	Order Code	Price	Order Code	Price	Order Code	Price
ES T3	1SDA051494R1	18.09	1SDA051495R1	24.24	1SDA051492R1	36.16	-	POA
ES T4	1SDA055040R1	27.50	-	POA	1SDA055038R1	54.99	1SDA055039R1	71.50

Front terminals for copper cables - FC Cu

Product Hierarchy 3000006

Type	3 pieces		4 pieces		6 pieces	
	Order Code	Price	Order Code	Price	Order Code	Price
FC Cu T2	1SDA051454R1	5.92	-	POA	-	POA
FC Cu T3	1SDA051482R1	8.53	1SDA051483R1	11.42	1SDA051480R1	17.07

POA Price on Application please consult us



Full range of product and technical information place this part number in a search engine and download

1SDC210015D0204

Power Distribution Circuit Breakers

Emax Air Circuit Breakers



Emax Air Circuit Breakers

Product Hierarchy 2900003

Description	Order Code	Price
X1N 1250 PR331/P LSIG In=1250A	1SDA062508R1	2884.30
X1N 1600 PR331/P LSI In=1600A 3p F	1SDA062606R1	2279.78
E1N 800 PR121/P-LSI In=800A 3p F HR	1SDA055697R1	2220.02
E1N 1000 PR121/P-LSIG In=1000A 4p W	1SDA059224R1	3245.42
E1N 1250 PR121/P-LSI In=1250A 3p F	1SDA055729R1	2343.17
E1N 1250 PR121/P-LSI In=1250A 3p W	1SDA055745R1	2489.39
E1N 1250 PR121/P-LSI In=1250A 4p F	1SDA055737R1	3100.58
E1N 1250 PR121/P-LSI In=1250A 4p W	1SDA055753R1	3200.70
E1N 1250 PR121/P-LSIG In=1250A 4p W	1SDA055754R1	3340.53
E1N 1600 PR121/P-LSI In=1600A 3p F	1SDA055761R1	2377.13
E1N 1250 PR121/P-LSI In=1250A 4p F	1SDA055737R1	3100.58
E1N 1250 PR121/P-LSI In=1250A 4p W	1SDA055753R1	3200.70
E1N 1250 PR121/P-LSIG In=1250A 4p W	1SDA055754R1	3340.53
E1N 1600 PR121/P-LSI In=1600A 3p F	1SDA055761R1	2377.13
E2N 1000 PR121/P-LSIG In=1000A 4p W	1SDA059268R1	3254.88
E2N 1250 PR121/P-LSI In=1250A 3p F	1SDA055857R1	2389.97
E2N 1250 PR121/P-LSI In=1250A 3p W	1SDA055873R1	2493.23
E2N 1250 PR121/P-LSI In=1250A 4p F	1SDA055865R1	3170.48
E2N 1250 PR121/P-LSIG In=1250A 4p W	1SDA055882R1	3351.08
E2N 1600 PR121/P-LSI In=1600A 3p F	1SDA055889R1	2470.76
E2N 1600 PR121/P-LSI In=1600A 4p F	1SDA055897R1	3302.77
E2N 1600 PR121/P-LSIG In=1600A 4p W	1SDA055914R1	4022.60
E2N 2000 PR121/P-LSI In=2000A 3p F	1SDA055921R1	3318.91
E2N 2000 PR121/P-LSI In=2000A 3p W	1SDA055937R1	3598.98
E2N 2000 PR121/P-LSI In=2000A 4p F	1SDA055929R1	4255.47
E2N 2000 PR121/P-LSIG In=2000A 4p W	1SDA055946R1	4885.92
E3N 2500 PR121/P-LSI In=2500A 3p F	1SDA056113R1	3859.08
E3N 2500 PR121/P-LSI In=2500A 3p W	1SDA056129R1	4788.11
E3N 2500 PR121/P-LSI In=2500A 4p F	1SDA056121R1	5521.54
E3N 2500 PR121/P-LSI In=2500A 4p W	1SDA056137R1	5992.19
E3N 2500 PR121/P-LSIG In=2500A 4p F	1SDA056122R1	5367.93
E3N 2500 PR121/P-LSIG In=2500A 4p W	1SDA056138R1	6516.25
E3N 3200 PR121/P-LSI In=3200A 3p F	1SDA056145R1	5222.91
E3N 3200 PR121/P-LSI In=3200A 4p F	1SDA056153R1	6762.11
E3N 3200 PR121/P-LSI In=3200A 4p W	1SDA056169R1	8331.17
E3N/MS 2500 4p W MP new	1SDA058988R1	4655.09



Power Distribution Circuit Breakers

Non-Automatic Emax Air Circuit Breakers



Non Automatic

Emax Air Circuit Breakers

Description	Product Hierarchy 2900003	
	Order Code	Price
T7-X1 W FP 4p HR-HR	1SDA062048R1	935.58
E2 W FP 3p HR-HR new	1SDA059667R1	634.40
E2 W FP 4p HR-HR new	1SDA059763R1	793.00
E2 W FP 4p VR-VR new	1SDA059771R1	863.83
E3 W FP 3p HR-HR new	1SDA059669R1	735.62
E3 W FP 4p HR-HR new	1SDA059765R1	948.95

3



Full range of product and technical information place this part number in a search engine and download
1SDC200009D0203

Power Distribution Circuit Breakers

Emax Air Circuit Breakers Accessories



PR1 Release

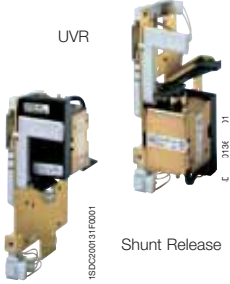

UVR

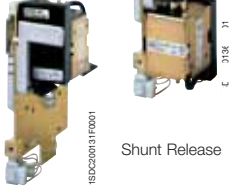

Shunt Release

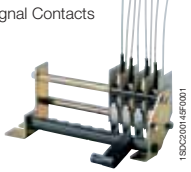

Signal Contacts



Motor Operator



Plastic Cover PR121



Full range of product and technical information place this part number in a search engine and download
1SDC20009D0203

Emax Air Circuit Breakers

Product Hierarchy 2900003

Description	Order Code	Price
PR121/P-LSI E1-E6	1SDA058193R1	629.58
PR121/P-LSIG E1-E6	1SDA058195R1	906.38
ELE.I1/4 TRIP RESE 24-30V PR12x E1-	1SDA058263R1	22.15
ELE.I1/4 TRIP RESE110-130V PR12x E1	1SDA058262R1	22.15
ELE.I1/4 TRIP RESE220-240V PR12x E1	1SDA058261R1	22.15
ELE.TIME DEL.xUVR 110/127V E1/6-T7-	1SDA038319R1	165.04
ELE.TIME DEL.xUVR 220/250V E1/6-T7-	1SDA038320R1	165.04
UNDER VOLTAGE RELEASE 220/240V E1	1SDA038312R1	140.74
UNDER VOLTAGE RELEASE 240/250V E1	1SDA038313R1	140.74
UNDER VOLTAGE RELEASE 24V DC E1/6	1SDA038306R1	140.74
UNDER VOLTAGE RELEASE 380/400V E1	1SDA038314R1	168.86
SHUNT OPEN.RELEASE 30V E1/6-T8	1SDA038287R1	84.43
SHUNT OPEN.RELEASE 110/120V E1/6	1SDA038290R1	84.43
4 OPEN/CLOSED AUX.CONTACTS E1/6	1SDA038326R1	111.32
ACCESSORY INTERLOCK W FP -C E1/6	1SDA038365R1	175.66
AUT.TRANS.SWITCH DEVICE ATS010 24-4	1SDA052927R1	1117.60
AUX-SA T7M-X1 1 S51 250Va.c.	1SDA063553R1	25.66
AUX-SC T7M-X1 250Vac/dc SPRINGS CHA	1SDA062107R1	16.55
BT030 WIREL.EXT.MOD.BLUE.E1/6-T4.T7	1SDA058259R1	478.35
CURR.S.EX.NEUTRAL N50-100%E1-2 N50%	1SDA058191R1	349.45
EMAX OPEN/CLOSE COIL 240VAC/DC	1SDA038293R1	84.43
INTERLOCK CABLES 3CB.S HORIZ. -C-	1SDA038331R1	227.45
IP54 PROTECT WITH KEYS LOCK SEV. E1	1SDA038344R1	176.81
KEY LOCK OPEN POS. DIFF. KEYS E1/6	1SDA058271R1	57.10
KIT CABLE x PR121-2-3/P xPR010/T E1	1SDA063383R1	256.91
KIT VR T7-T7M-X1 8pcs	1SDA063127R1	136.08
KIT W FP 3p HR 3pcs E3 >FP VR	1SDA055483R1	224.09
MECC.OPERATION COUNTER E1/6-T8	1SDA038345R1	75.47
MOTOR OPERATOR 24/30V E1	1SDA038321R1	511.69
NEW E1N 800 PR121-LSI 3P	1SDA055713R1	2356.97
PADLOCK DEVICE FOR SHUTTERS E1/6	1SDA038363R1	35.95
PLASTIC COVER PR121	1SDA063226R1	81.94
PR030/B BATTERY UNIT E1/6-T7-T7M-X1	1SDA058258R1	89.75
PUSHBUTTONS PROTECTION E1/6-T8	1SDA038343R1	23.18
RATING PLUG In=1600A E1-E6IEC E2-E4	1SDA058226R1	34.94
RATING PLUG In=2500A E3-E6IEC E3-E4	1SDA058228R1	34.94
UNIT PR010/T-T8	1SDA048964R1	3536.25

Notes

3



Switchgear - Switch Disconnectors, Switch Fuses and Cam Switches

Switch Disconnectors

OT 16...1600 Disconnectors	78 - 79
OT Accessories	80 - 83
OT 16... 2500 Changeover Switches	84 - 85

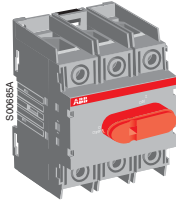

Switch Fuses

OS16...160 Switchfuses.....	86
OS200...800 Switchfuses.....	87
OS Accessories.....	88 - 92
BS88 Fuses.....	93 - 94



XR SlimLine Switch Fuses

SlimLine Switch Fuses.....	95
----------------------------	----



Cam Switches

Cam Switches Open Type.....	96
-----------------------------	----

The switches in this catalogue only represent a small selection of the full range available.

DIN, NFC, CSA and UL type switches are readily available & all switches are made in many different configurations e.g. plug-in terminals, side operation, back connection terminals, side to side terminals, please refer to our technical brochure for full details.

Switch Disconnectors



Full range of product and technical information place this part number in a search engine and download
1SCC301001C0201

Switch Fuses



Full range of product and technical information place this part number in a search engine and download
1SCC311013C0201

Changeover Switches



Full range of product and technical information place this part number in a search engine and download
1SCC303003C0201

XR SlimLine Switch Fuses



Full range of product and technical information place this part number in a search engine and download
1SEC311001C0201

Cam Switches



Full range of product and technical information place this part number in a search engine and download
1SCC302003C0201

Switch Disconnectors

OT 16...800E

Front operated switch-disconnectors, base and DIN-rail mounting

Including protected terminal clamps, IP20. Handle and shaft have to be ordered separately.

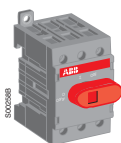

OT16...32E3

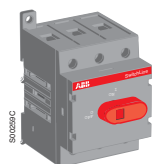

OT 45...63E3

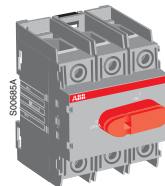

OT 100...125E3

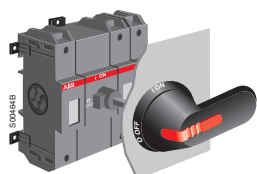

OT 160E3

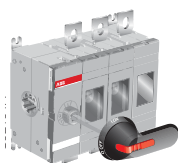

OT200 - 250

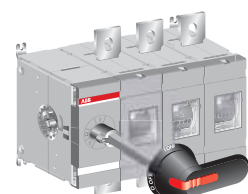

OT630 - 800



Full range of product and technical information place this part number in a search engine and download

1SCC301001C0201

OT 16 - 125

No of Poles	I_{th} (open) [A]	Cable Cross Section mm ²	Operational Currents AC22A/AC23A 400V	Product Hierarchy 2200003	
				Order Code	Price
3	25	0.75...10	16/16	OT16F3	12.32
4	25	0.75...10	16/16	OT16F4N2	16.10
3	32	0.75...10	25/20	OT25F3	13.20
4	32	0.75...10	25/20	OT25F4N2	17.10
3	63	1.5...35	40/23	OT40F3	14.98
4	63	1.5...35	40/23	OT40F4N2	19.23
3	80	1.5...35	63/45	OT63F3	22.69
4	80	1.5...35	63/45	OT63F4N2	27.84
3	100	1.5...50 ⁴⁾	80/75	OT80F3	24.72
4	100	1.5...50 ⁴⁾	80/75	OT80F4N2	32.46
3	115	10...70	100/80	OT100F3	42.44
4	115	10...70	100/80	OT100F4N2	51.61
3	125	10...70	125/90	OT125F3	58.05
4	125	10...70	125/90	OT125F4N2	72.03

OT 160

No of Poles	I_{th} (open) [A]	Operational Currents AC22A/AC23A 400V	Shaft Diameter mm	Product Hierarchy 2200003	
				Order Code	Price
3	200	200/135	6	OT160E3	94.07
4	200	200/135	6	OT160E4	125.43

Including the handle OHB65J6, IP65, and shaft OXP6X210, length 210mm

Front operated switch-disconnectors, with pistol handle

OT 200...800

Including a black ON-OFF plastic handle and shaft as standard. The handle is IP65 protected, padlockable in the OFF-position and with door interlock in the ON-position. The shaft is adjustable for a range of installation depths.

OT 200 - 800

No of Poles	I_{th} (open) [A]	Operational Currents AC22A/AC23A 400V	Product Hierarchy 2200003	
			Order Code	Price
3	200	200/200	OT200E03P	95.24
4	200	200/200	OT200E04P	110.06
3	250	250/250	OT250E03P	147.48
4	250	250/250	OT250E04P	165.32
3	315	315/315	OT315E03P	161.47
4	315	315/315	OT315E04P	213.67
3	400	400/400	OT400E03P	188.40
4	400	400/400	OT400E04P	215.64
3	630	630/630	OT630E03P	332.20
4	630	630/630	OT630E04P	378.89
3	800	800/800	OT800E03P	460.60
4	800	800/800	OT800E04P	520.03

Switch Disconnectors

OT 1000...1600 OT 16...125 Door Mounting

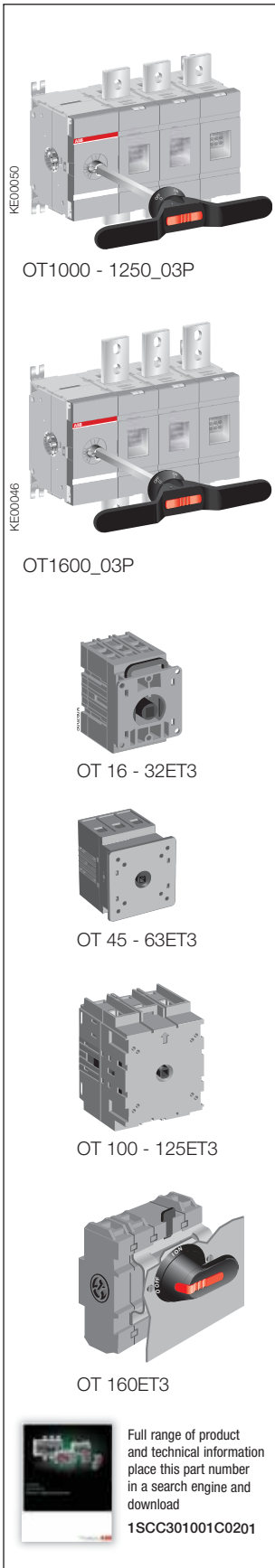

Front operated switch-disconnectors

OT 1000...1600

Including standard terminal bolt kit, a black ON-OFF plastic handle OHB200J12P and shaft OXP12x280 as standard. The handle is IP65 protected, padlockable in the OFF-position and with door interlock in the ON-position. The shaft is adjustable for a range of installation depths.

No of Poles	I_{th} (open) [A]	Operational Currents AC22A/AC23A 400V	Product Hierarchy 2200003	
			Order Code	Price
3	1000	1000/800	OT1000E03P	804.12
4	1000	1000/800	OT1000E04P	917.87
3	1250	1250/1000	OT1250E03P	890.41
4	1250	1250/1000	OT1250E04P	1090.46
3	1600	1600/1000	OT1600E03P	1372.88
4	1600	1600/1000	OT1600E04P	1561.10

Door mounting, front operated switch-disconnectors,

OT16...125

Including protected terminal clamps, IP20. The handle has to be ordered separately.

No of Poles	I_{th} (open) [A]	Cable Cross Section mm ²	Operational Currents AC22/AC23 415V	Product Hierarchy 2200003	
				Order Code	Price
3	25	0.75...10	16/16	OT16FT3	15.42
4				OT16FT4N2	20.60
3	32		25/20	OT25FT3	19.29
4				OT25FT4N2	24.70
3	40	1.5...35	40/23	OT40FT3	21.98
4				OT40FT4N2	27.67
3	63		63/45	OT63FT3	24.92
4				OT63FT4	32.43
3	115	10...70	100/80	OT100FT3	52.82
4				OT100FT4	66.79
3	125		125/90	OT125FT3	56.04
4				OT125FT4N2	70.05

Full range of product and technical information place this part number in a search engine and download
1SCC301001C0201

Switch Disconnectors

Accessories

S00262A



OTP_32_

S00263A



OTP_63_

S00387A



OTP_80_

S01342A



OTP_125_

S01260A

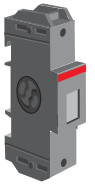

OTZNA1-160E4
OTP_160EP



Full range of product and technical information place this part number in a search engine and download

1SCC301001C0201

Aux Contacts	For Switch Type	Product Hierarchy 2200001	
		Order Code	Price
1NC	OT16 .. OT125	OA1G01	5.39
1NO+1NC		OA2G11	7.36
1NO	OT200 .. OT2500	OA1G10	5.39
1NC		OA3 G01	5.39
1N/C	OT160	OBEA01	5.39
1N/O		OBEA10	5.39
Aux Contact Frame	OT160	OEZNP1	9.06
	OT160	OAZX1	7.76
	for OBEA	OEZNP1	9.06
	OT200 .. OT2500	OEA28	9.34

Add on Poles and Neutrals

Fixed Neutral Pole	OT16 .. 40F3	OTPN40FP	4.56
	OT63 .. 80F3	OTPN80FP	6.85
	OT100 .. 125F3	OTPN125FP	15.54
Detach Neutral	OT16 .. 40F3	OTPD40FP	4.56
	OT63 .. 80F3	OTPD80FP	6.85
	OT100 .. 125F3	OTPD125FP	15.54
	OT160F3	OTPN160EP	26.18
40A Fourth Pole	OT16 .. 40F3	OTPS40FPN1	4.56
63A..80A Fourth Pole	OT63 .. 80F3	OTPS80FP	6.85
125..160A Fourth Pole	OT100 .. 125F3	OTPS160EP	26.18
Neutral Pole Late Break/Early Make	OT16 .. 40F3	OTPL40FP	4.56
	OT16 .. 40F3	OTPE40FP	4.56
Earth Pole	OT63 .. 80F3	OTPE80FP	6.85
	OT125 ..160	OTPE160EP	26.07

Switch Disconnectors

Accessories

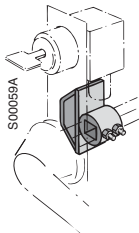

OETLZW 5

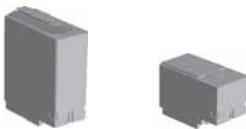

Locks and Terminal Shrouds

Description	For Switch	Product Hierarchy 2200001		
		Order Code	Price	
Castell Lock Cam Attachment	OT16 .. OT250	OETLZW16	42.58	
	OT315 .. OT2500	OETLZW5	29.84	
6/8 Pole Attachment	OT16 .. OT125	OETLZW8	19.65	
	OT160 .. OT250	OESA2W2	59.88	
	OT315 .. OT800	OETLZW9	98.12	
1 Pole Terminal Shroud	OT_40F	OTS40T1	1.82	
3 Pole Terminal Shroud	OT16 .. 40F3	OTS40T3	2.66	
4 Pole Terminal Shroud	OTP_80F	OTS63T1	3.11	
1 Pole Terminal Shroud	OT100 .. OT125E	OTS125T1	4.38	
3 Pole Terminal Shroud	OT100 .. OT125E,ET3	OTS125T3	5.85	
3 Pole Terminal Shroud	OT125 .. 160E3	OTS160T3	22.99	
4 Pole Terminal Shroud	OT125 .. 160E4	OTS160T4	29.99	
1 Pole Terminal Shroud	OT160E	OTS160T1	4.06	
3 Pole Terminal Shroud Long (3 off)	OT200 .. OT250	OTS250G1L/3	19.11	
		OTS250G1S/3	17.35	
	OT315 .. OT400	OTS400G1L/3	26.68	
		OTS400G1S/3	21.34	
	OT630 .. OT800	OTS800G1L/3	57.17	
		OTS800G1S/3	42.87	
	OT1000 .. OT1600	OTS1600G1L/3	30.95	
		OTS1600G1S/3	24.74	
	OT2000 .. OT2500	OTS2500G1L/3	40.95	
		OTS2500G1S/3	32.90	
	Description	Suitable for	Order Code	Price
	Snap on transparent plastic IP 2X	OZXB2, 2L	OZXB2K	13.75
OZXB3, 4		OZXB3K	25.93	
OZXB5, 6		OZXB4K	38.56	
OZXB7, 7L		OZXB5K	39.29	



Full range of product and technical information place this part number in a search engine and download
1SCC301001C0201

Switch Disconnectors

Accessories



OHBS1



OHBS2



OHBS1PH



OHBS2AJ



OHBS2AJ1



OHBS2R2J

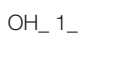

OHBS3AH



OHBS3AH1



OHBS3PH

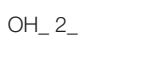

OHYS1AH



OHYS2AJ



OHYS2AJ1

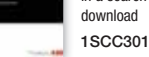

OHYS2PJ



OHYS3AH

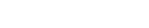

OHYS3AH1

OHYS3PH

OHYS3RH

OHYS3RH1

OHYS3PH

OHYS3RH

OESAZX167

OETLZX95

OETLZK19

OETLZX58

OXS6X85

OXS6X130

OXS6X180

OXS6X250

OXS6X330

OT16 ... 125 Handles & Shafts

Description

Product Hierarchy 2200001

Description	Order Code	Price
Black Direct Mounted Handle	OHBS1	3.07
IP54 Handle Blk and Defeatable in the ON position	OHBS1AH1	3.82
IP54 Door Mtd Handle Black	OHBS1PH	4.56
Handle Direct Mtd Black	OHBS2	3.77
IP65 Handle Black Interlockable and Defeatable	OHBS2AJ	5.48
IP65 Handle Black Padlockable	OHBS2AJ1	4.56
IP65 Door Mtd Handle Black Screw Type	OHBS2R2J	6.88
IP54 Blk Handle 1 P/Lk	OHBS3AH	4.04
IP54 Blk Handle 1 P/Lk	OHBS3AH1	4.38
IP54 D/Mount Blk Handle 1 P/Lk	OHBS3PH	4.38
IP54 Handle Red/Yellow	OHYS1AH	2.97
IP54 Handle Door Interlocked and Defeatable in the ON position	OHYS1AH1	3.82
IP65 Handle/Yellow Interlockable and Defeatable	OHYS2AJ	5.48
IP65 HdI Red/Yellow Padlockable	OHYS2AJ1	4.56
IP65 Door Mtd Handle Red/Yellow	OHYS2PJ	6.88
IP65 Door Mtd Handle Red/Yellow Screw Type	OHYS2R2J	6.88
IP54 Selector Handle IP54 Padlockable	OHYS3AH	4.04
IP54 Selector Handle Y/R Padlockable	OHYS3AH1	4.38
IP54 Selector Handle	OHYS3PH	4.38
IP54 D/Mount R/Y Handle 1 P/Lk Screw Type	OHYS3RH	4.38
Shaft Extension Socket 6mm	OESAZX167	17.67
Shaft Extension Socket 12mm	OETLZX95	26.80
6-12mm Adaptor For Extension	OETLZK19	17.08
Shaft Support Bracket	OETLZX58	4.76
85mm Shaft For OT Switches	OXS6X85	2.02
130mm Shaft For OT Switches	OXS6X130	2.20
180mm Shaft For OT Switches	OXS6X180	2.74
250mm Shaft For OT Switches	OXS6X250	3.46
330mm Shaft For OT Switches	OXS6X330	4.20



Full range of product and technical information place this part number in a search engine and download

1SCC301001C0201

Switch Disconnectors

Accessories

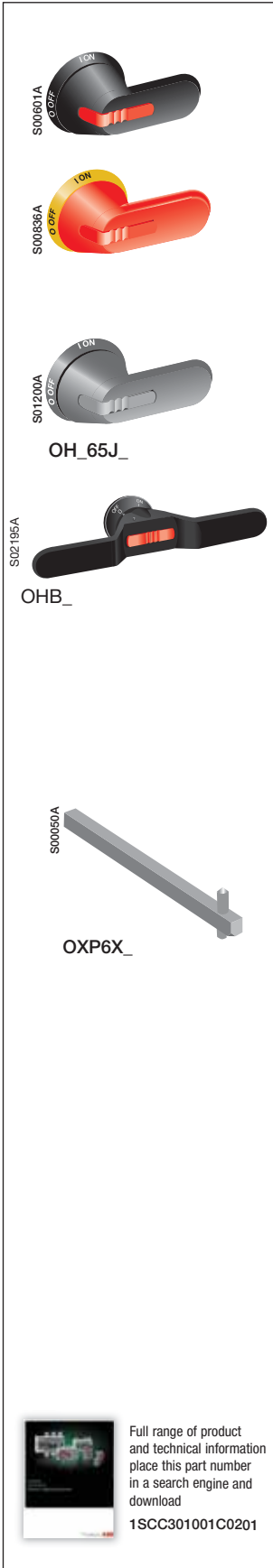

Optional handles, IP65

For front operated switch disconnectors

Padlockable with 3 padlocks in the OFF-position, door interlock in the ON-position. Units/type = 1 pcs. Screw fixing from the back side of the handle, no screws on the front, ensures double protection.

Description	Product Hierarchy 2100004	
	Order Code	Price
For 6 mm shaft		
Black	OHB65J6	13.58
Red-Yellow	OHY65J6	13.58
Black - Test	OHB65J6T	15.50
For 12mm shaft		
Black	OHB125J12	35.54
Black	OHB145J12	35.54
Black	OHB175J12	37.49
Black Butterfly Handle On/Off	OHB150J12P	42.60
Black Butterfly Handle On/Off	OHB200J12P	45.43

Shafts

6 mm

Shaft Length mm

150	EXP6X150	2.56
210	EXP6X210	3.14
265	EXP6X265	4.11
400	EXP6X400	5.77

12 mm

Shaft Length mm

250	EXP12X250	8.17
280	EXP12X280	8.43
325	EXP12X325	9.11
395	EXP12X395	9.96
465	EXP12X465	11.97
535	EXP12X535	16.72



Full range of product and technical information place this part number in a search engine and download
1SCC301001C0201

Switch Disconnectors

Manual Change-over switches OT16...2500



Change-over switches, 3 & 4 pole, I-O-II -indication

Includes terminal clamps IP20. Handle and shaft has to be ordered separately.

Rated current / Rate Power AC-21A...AC-22A		AC-23A 400-415V I/[A], P/[kW]	Number of Poles	Product Hierarchy 2200003	
Up to 415V I/[A]	400V S/[kVA]			Order Code	Price
16	11	16/7.5	3	OT16F3C	31.54
			4	OT16F4C	39.66
63	43	45/22	3	OT40F3C	41.92
			4	OT40F4C	50.89
80	55	75/37	3	OT63F3C	55.42
			4	OT63F4C	66.21
100	70	80/37	3	OT100F3C	132.44
			4	OT100F4C	162.80
125	86	90/45	3	OT125F3C	152.00
			4	OT125F4C	167.00

Manual Change-over switches, 3 & 4 pole, I-O-II -indication

Including a black plastic IP65 I-O-II pistol type handle, padlockable in the O-position, door interlock in the I- & II-positions and when padlocked.

Rated current / Rated Power AC-21A...AC-22A			AC-23A 400-415V I/[A], P/[kW]	Number of Poles	Product Hierarchy 2200003	
Up to 415V I/[A]	400V S/[kVA]	Order Code			Price	
Mechanism at the end of the switch						
160	110	160/90	3	OT160E03CP	290.00	
			4	OT160E04CP	313.00	
200	135	200/110	3	OT200E03CP	410.00	
			4	OT200E04CP	445.00	
250	170	250/140	3	OT250E03CP	420.00	
			4	OT250E04CP	460.00	
315	215	315/160	3	OT315E03CP	490.00	
			4	OT315E04CP	570.00	
400	275	400/220	3	OT400E03CP	550.00	
			4	OT400E04CP	615.00	
630	435	630/355	3	OT630E03CP	645.00	
			4	OT630E04CP	720.00	
800	550	800/450	3	OT800E03CP	965.00	
			4	OT800E04CP	1,140.00	
1000	680	1000/560	3	OT1000E03CP	1,900.00	
			4	OT1000E04CP	2,500.00	
1250	850	1250/710	3	OT1250E03CP	2,150.00	
			4	OT1250E04CP	2,700.00	
1600	1000	1250/710	3	OT1600E03CP	3,274.25	
			4	OT1600E04CP	3,974.51	
2000	1350	-	3	OT2000E03CP	3,400.00	
			4	OT2000E04CP	4,380.00	
2500	1700	-	3	OT2500E03CP	4,000.00	
			4	OT2500E04CP	4,860.00	

Switch Disconnectors

Motorised Change-over switches OTM16...2500

Motorised Change-over switches, 3 & 4 pole, I-O-II -indication

Including a handle for manual operation, bolt kit with nut and washers for all terminals.



OTM160...250E3_



OTM160...250E4_



OTM160...250E3W_



OTM315...400E3_



OTM315...400E4_



Full range of product and technical information place this part number in a search engine and download

1SCC303003C0201

Rated current / Rated Power AC-21A...AC-22A		AC-23A 400-415V	Number of Poles	Product Hierarchy 2200003	
Up to 415V I/[A]	400V S/[kVA]	400-415V I/[A], P/[kW]		Order Code	Price
160	110	160/160	3	OTM160E3CM230C	1,100.00
			4	OTM160E4CM230C	1,130.00
200	135	200/200	3	OTM200E3CM230C	1,341.91
			4	OTM200E4CM230C	1,400.00
250	170	250/250	3	OTM250E3CM230C	1,395.00
			4	OTM250E4CM230C	1,435.00
315	215	315/315	3	OTM315E3CM230C	1,500.00
			4	OTM315E4CM230C	1,580.00
400	275	400/400	3	OTM400E3CM230C	1,820.00
			4	OTM400E4CM230C	1,985.00
630	435	650/650	3	OTM630E3CM230C	2,710.00
			4	OTM630E4CM230C	2,800.00
800	550	720/650	3	OTM800E3CM230C	3,300.00
			4	OTM800E4CM230C	4,500.00
1000	680	1000/1000	3	OT1000E3CM230C	3,480.00
			4	OT1000E4CM230C	3,650.00
1250	850	1250/1000	3	OT1250E3CM230C	3,680.00
			4	OT1250E4CM230C	3,900.00
1600	1000	1600/1000	3	OT1600E3CM230C	4,060.00
			4	OT1600E4CM230C	4,300.00
2000	1350	-	3	OT2000E3CM230C	7,901.00
			4	OT2000E4CM230C	8,500.00
2500	1700	-	3	OT2500E3CM230C	8,450.00
			4	OT2500E4CM230C	8,875.00

4

Switch Fuses

Switch fuses OS20...160

Front operated switch fuses

Including terminal bolt kit (OS100...160), a black ON-OFF plastic handle and shaft as standard. The handle is IP65 protected, padlockable in the OFF-position and with door interlock in the ON-position. The shaft is adjustable for a range of installation depths.



Rated current AC-20...23 ≤ 690V [A]	Rated Power AC-23 400/500/690V [kW]	Fuse Size	No. of poles	Product Hierarchy 2100002	
				Order Code	Price

Mechanism between the poles

20	7.5/11/15	A1	3	OS20FB12A1-2	29.35
			4	OS20FB22A1N1	50.08
32	15/18/25	A1	3	OS32FB12A1	54.00
			4	OS32FB22A1N1	62.70
	15/18.5/22	A2	3	OS32FB12A2	54.00
32	15/18.5/22	A2, A3	3	OS32GB12P	57.20
			4	OS32GB22N1P	69.00
63	30/37/55	A2, A3	3	OS63GB12P	82.80
			4	OS63GB22N1P	104.77
100	55/55/90	A2, A3	3	OS100GB12P	113.56
			4	OS100GB22N1P	145.62
125	55/75/110	A2, A3, A4 ¹⁾	3	OS125GB12P	158.00
			4	OS125GB22N1P	173.53
160	75/90/132	A2, A3, A4 ¹⁾	3	OS160GB12P	166.00
			4	OS160GB22N1P	207.00

Mechanism at the end of the switch fuse

32	15/18.5/22	A2, A3	3	OS32GB03P	56.20
			4	OS32GB04N1P	67.00
63	30/37/55	A2, A3	3	OS63GB03P	80.50
			4	OS63GB04N1P	98.50

Terminal Bolt Kit

100	55/55/90	A2, A3, A4 ¹⁾	3	OS100GB03P	104.68
			4	OS100GB04N1P	130.67
125	55/75/110	A2, A3, A4 ¹⁾	3	OS125GB03P	139.58
			4	OS125GB04N1P	166.17
160	75/90/132	A2, A3, A4 ¹⁾	3	OS160GB03P	163.00
			4	OS160GB04N1P	202.00

¹⁾ Max. fuse diameter 32 mm N1 = Non-fused neutral on the left side

Shafts, handles & bolt kits included as standard

Suitable for switches	Included shaft	Included handle	Included terminal bolts
OS20...32FB (OS Mini)	OXF6X150	OHB65J6	-
OS32G...63G_P	OXF6X161	OHB45J6	-
OS100G...160G_P	OXF6X161	OHB65J6	M8x25

Full range of product and technical information place this part number in a search engine and download
1SCC311013C0201



Switch Fuses

Switch fuses OS200...800

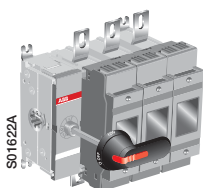

OS200B03

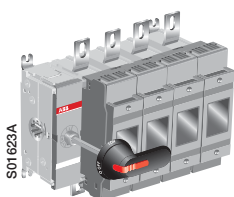

OS200B04

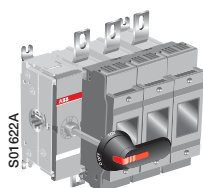

OS250B03

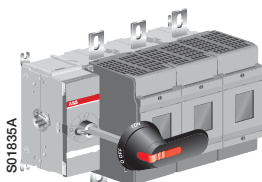

OS315...400B03



Full range of product and technical information place this part number in a search engine and download
1SCC311013C0201

Front operated switch fuses

Including terminal bolt kit, a black ON-OFF plastic handle and shaft as standard. The handle is IP65 protected, padlockable in the OFF-position and with door interlock in the ON-position. The shaft is adjustable for a range of installation depths.

Rated current AC-20...23 ≤ 690V [A]	Rated Power AC-23 400/500/690V [kW]	Fuse Size	No. of poles	Product Hierarchy 2100002	
				Order Code	Price
Mechanism between the poles					
200	110/132/200	B1-B2	3	OS200B12P	225.84
			4	OS200B22N2P	260.69
250	140/170/250	B1-B3	3	OS250B12P	278.73
			4	OS250B22N2P	325.73
315	160/220/220	B1-B4	3	OS315B12P	316.36
			4	OS315B22N2P	453.30
400	220/280/400	B1-B4	3	OS400B12P	411.70
			4	OS400B22N2P	545.58
630	355/450/630	C1-C2	3	OS630B12P	785.45
			4	OS630B22N2P	1023.35
800	450/560/710	C1-C2	3	OS800B12P	1011.01
			4	OS800B22N2P	1305.70
Mechanism at the end of the switch fuse					
200	110/132/200	B1-B2	3	OS200B03P	216.34
			3+N ¹⁾	OS200B03N3P	239.21
			4	OS200B04N2P	268.41
250	140/170/250	B1-B3	3	OS250B03P	278.73
			4	OS250B04N2P	325.73
315	160/220/220	B1-B4	3	OS315B03P	316.36
			3+N ¹⁾	OS315B03N3P	384.84
			4	OS315B04N2P	453.30
400	220/280/400	B1-B4	3	OS400B03P	413.21
			3+N ¹⁾	OS400B03N3P	439.80
			4	OS400B04N2P	525.97
630	355/450/630	C1-C2	3	OS630B03P	678.19
			3+N ¹⁾	OS630B03N3P	847.79
			4	OS630B04N2P	837.96
800	450/560/710	C1-C3	3	OS800B03P	965.68
			4	OS800B04N2P	1305.70

¹⁾ Include a detachable neutral link integrated into the mechanism

Shafts, handles & bolt kits included as standard

Suitable for switches	Included shaft	Included handle	Included terminal bolts
OS200_P	OXF6X210	OHB65J6	M8x25
OS250_P	OXF6X210	OHB65J6	M10x30
OS315...400_P	OXF12X250	OHB95J12	M10x30
OS630...800_P	OXF12X395	OHB145J12	M12x40

Switch Fuses

Accessories

Optional handles, IP65

For front operated switch fuses

Padlockable with 3 padlocks in the OFF-position, door interlock in the ON-position. Units/type = 1 pcs.
Screw fixing from the back side of the handle, no screws on the front, ensures double protection.



OH_65J_



OHB_

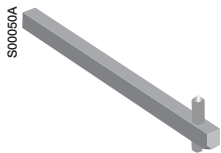

OSP6X_



Full range of product and technical information place this part number in a search engine and download
1SCC311013C0201

Product Hierarchy 2100004

Description	Shaft Length mm	Product Hierarchy 2100004	
		Order Code	Price
For 6 mm shaft			
Black	65	OHB65J6	13.58
Red-Yellow		OHY65J6	13.58
Black - Test		OHB65J6T	15.50
For 12mm shaft			
Black ON/OFF	95	OHB95J12	35.54
	125	OHB125J12	35.54
	145	OHB145J12	35.54
	175	OHB175J12	37.49
Black Butterfly Handle ON/OFF	150	OHB150J12P	42.60
	200	OHB200J12P	45.43
Black ON/OFF/TEST	95	OHB95J12T	43.75
	125	OHB125J12T	41.24
	145	OHB145J12T	41.24

Shafts

6 mm

Shaft Length mm

150	OSP6X150	2.56
210	OSP6X210	3.14
265	OSP6X265	4.11
400	OSP6X400	5.77

12 mm

Shaft Length mm

250	OSP12X250	8.17
280	OSP12X280	8.43
325	OSP12X325	9.11
395	OSP12X395	9.96
465	OSP12X465	11.97
535	OSP12X535	16.72
535	OSP12X535	16.72

Switch Fuses

Accessories

OS Mini

S00261A
OA_G

S00040A
MCB_

S01163B
OSZ4

S00544A
OESAZX169

Full range of product and technical information place this part number in a search engine and download
1SCC311013C0201

Auxiliary contacts

Product Hierarchy 2100004

OS Mini

Order Code	Price
------------	-------

Auxiliary contacts for OS Mini

Mounting to the switch mechanism, auxiliary/test contacts. Max. two change over contacts.

Change-over contacts

Handle position	Main contacts	Aux. / Test contacts N.O.		Order Code	Price
		open	closed		
Test 0 I	open open closed	closed open closed	OA4B1C	8.28	

Single pole contacts > 3mm contact gap

1NO		OA4B10	8.34
1NC		OA4B01	8.34

Mounting on the side of the switch with aux. frame OESAZX169

1NO		MCB-10	2.58
1NC		MCb-01	2.58

Snap-on mounting on the switch, by using a frame OSZ4. IP20.

NO contacts are provided with a positive opening feature. Units/type = 1 piece. Types _AU have gold plated contacts for harsh environments and low operating voltages.

1NO		OA1G10	5.39
1NC		OA3G01	5.39
1NO		OA1G10AU	6.93
1NC		OA3G01AU	6.93

Mounting frames for auxiliary contacts of OS Mini

Description	Order Code	Price
Frame for auxiliary contacts OA1G10 & OA3F01 & for fuse monitor. Max. 6 auxiliary contacts can be fitted.		
Mounting on the left side of the switch	OSZ4	3.44
Frame for MCB_ auxiliary contacts. Not suitable for side operated switches. Max. 6 auxiliary contacts can be fitted.		
Mounting on the right side of the switch	OESAZX169	4.86

4

Switch Fuses

Accessories

4

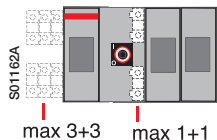

max 3+3 max 1+1

OS 30...60

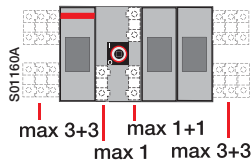

max 3+3 max 1+1
max 1 max 3+3

OS 100...200

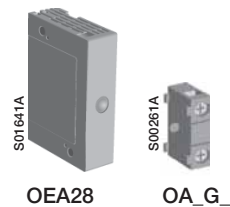

OEA28

OA_G_



Full range of product and technical information place this part number in a search engine and download

1SCC311013C0201

Auxiliary contacts for OS32G ... 1250

The "test" contacts operate in ON- and OFF-positions as well as when the handle is turned to TEST position = 45 degrees over the OFF-position. The "test indication" contacts operate only when the handle is turned to TEST-position. See the function table below. The OA1G10 (N.O.) or OA3G01 (N.C.) auxiliary contact blocks can be used as standard auxiliary contacts, "test" or "test indication" contacts. The desired functions are achieved when an auxiliary contact block is installed in a specific place shown in the mounting instruction. In order to activate the "test" and "test indication" features a handle with test function is required. See the optional handles, page 88.

Function table of OS32G...1250 auxiliary contacts

Handle position	Main contacts	Aux./Test contacts N.O.	Test indication contacts N.O.
Test	open	closed	closed
0	open	open	open
I	closed	closed	open

Maximum number of contact blocks, "Aux./test" contacts and "test indication" contacts, see the table below. Standard versions include all except for N3-types which are equipped with integrated neutral through the mechanism.

Maximum number of auxiliary contacts under the mechanism cover

Pole version	Standard	N3	Standard	N3	Standard	N3
Maximum number of contact blocks	4	0	8	4	12	8
Aux./Test contacts	4	0	4	2	8 ¹⁾	6 ²⁾
Test indication contacts	2	0	4	2	4	2

Auxiliary contacts for OS32G...1250

Mounting on the left side of the switch: Max. 8 auxiliary contact blocks with the OEA28 module.

Mounting under the mechanism cover: - OS200...250: Max 4 test contacts or 2 test contacts + 2 test indication contacts.

- OS315...400: Max 4 test contacts and 4 test indication contacts. The test contacts can be used as standard auxiliary contacts as well. Auxiliary contacts for 3 + N types only with the OEA28 module.

Description	Product Hierarchy 2100004	
	Order Code	Price
Module for auxiliary contacts screw mounting to the left side of the switch	OEA28	9.34
1 NO contact block	OA1G10	5.39
1 NC contact block	OA3G01	5.39

Switch Fuses

Accessories

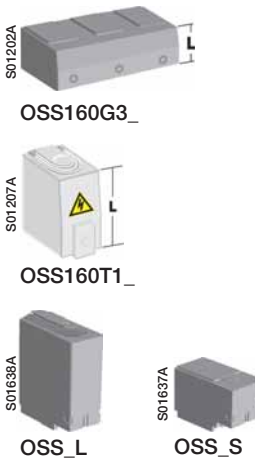

S01202A
OSS160G3_

S01207A
OSS160T1_

S01638A
OSS_L

S01637A
OSS_S



Full range of product and technical information place this part number in a search engine and download
1SCC311013C0201

Terminal shrouds OS100 ... 800

		Product Hierarchy 2100004	
Suitable Switch	Handle Type	Order Code	Price
OS 100G ... 160G	Long type	OSS160GG1L/3	6.54
	Short type	OSS160GG1S/3	6.00
	Long type	OSS160GG1L/4	8.72
	Short type	OSS160GG1S/4	8.00
OS 200	Long type	OSS200G1L/3	15.18
	Short type	OSS200G1S/3	14.56
	Long type	OSS200G1L/4	20.25
	Short type	OSS200G1S/4	18.66
OS 250	Long type	OSS250G1L/3	16.35
	Short type	OSS250G1S/3	15.18
	Long type	OSS250G1L/4	21.79
	Short type	OSS250G1S/4	21.03
OS 315...400	Long type	OSS400G1L/3	19.69
	Short type	OSS400G1S/3	19.11
	Long type	OSS400G1L/4	26.25
	Short type	OSS400G1S/4	25.47
OS 630...800	Long type	OSS800G1L/3	35.52
	Long type	OSS800G1L/4	44.38

Switch Fuses

Accessories



Neutral links

Product Hierarchy 2100004				
Max. wire	H/W/D [mm]	Mounting holes	Order Code	Price
For OS Mini and OS 32...63 Detachable, mounting on the side of the switch, on the mounting plate or DIN-rail.				
16mm ² Cu	39/41/40	ø 4.2, distance 32	OESAZX171	9.03
For OS 30...160 Detachable, mounting onto the base plate or DIN-rail.				
16mm ² Cu	39/41/40	ø 4.2, distance 32	OSZ1	6.99
35mm ² Cu	39/44/45	ø 4.2, distance 365	OSZ2	10.51
For OS 200...400 Mounting with screws (included) onto either side of the switch or on the base plate.				
OS200...250			OXN250	31.43
OS315...400			OXN400	50.18
OS630...800			OXN800S	78.91

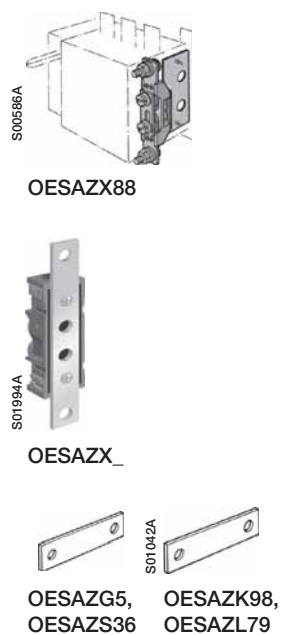

Product Hierarchy 2100004				
I _{th} [A]	Terminal size (WxD) [mm]; bolt size	Order Code	Price	
Mounting separately to the base plate				
250	12x3 ø 6,5	OESAZX162	19.25	
400	25x4 ø 11	OESAZX165	24.48	

Solid links

Product Hierarchy 2100004				
Fuse type	Suitable for	Order Code	Price	
A1	OS 20B...OS 32B 1	OESAZG98	3.85	
BS 88: A2...A3	OS 32B...OS 100B 1	OESAZG5	4.74	
BS 88: A4	OS 125B...OS 160B 1	OESAZS36	8.42	
	OESA 400B	OESAZK98	15.24	
	OESA 630B, 800B	OESAZL79	42.23	



Full range of product and technical information place this part number in a search engine and download
1SCC311013C0201

Switch Fuses

BS 88 Fuses

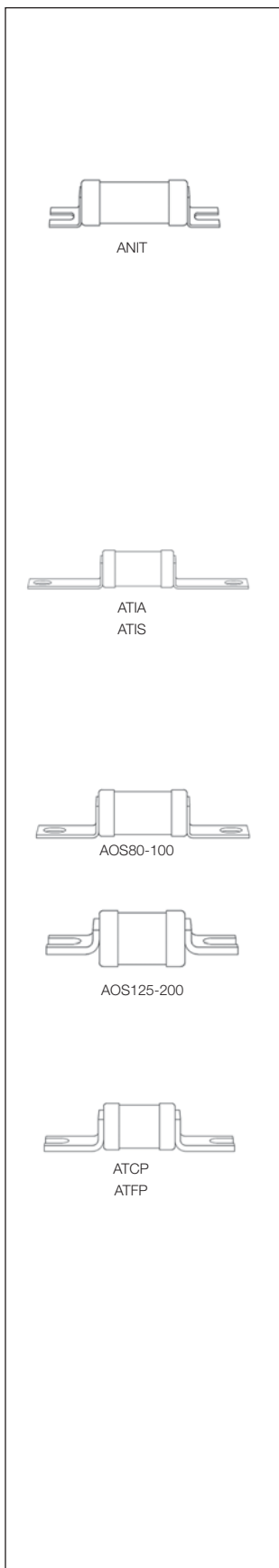

Fuse Size	Product Hierarchy 2000002	
	Order Code	Price £
2A A1 fuselink	ANIT2	1.37
4A A1 fuselink	ANIT4	1.37
6A A1 fuselink	ANIT6	1.37
10A A1 fuselink	ANIT10	1.37
16A A1 fuselink	ANIT16	1.37
20A A1 fuselink	ANIT20	1.84
25A fuselink	ANIT25	1.97
32A fuselink	ANIT32	1.97
2A A2 fuselink	ATIA2	2.20
4A A2 fuselink	ATIA4	2.20
6A A2 fuselink	ATIA6	2.20
10A A2 fuselink	ATIA10	2.20
16A A2 fuselink	ATIA16	2.20
20A A2 fuselink	ATIA20	2.44
25A A2 fuselink	ATIA25	2.61
32A A2 fuselink	ATIA32	2.61
35A A3 fuselink	ATIS35	4.14
40A A3 fuselink	ATIS40	4.14
50A A3 fuselink	ATIS50	4.14
63A A3 fuselink	ATIS63	4.41
80A fuselink	AOS80	4.67
100A fuselink	AOS100	5.15
125A fuselink	AOS125	10.72
160A fuselink	AOS160	11.80
200A fuselink	AOS200	12.35
80A A4 fuselink	ATCP80	6.30
100A A4 fuselink	ATCP100	6.30
125A fuselink	ATFP125	10.82
160A fuselink	ATFP160	11.80
200A fuselink	ATFP200	12.34

Switch Fuses

BS 88 Fuses

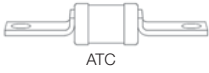

ATC



ATF
ATKF
ATMF
ATKM

Fuse Size	Product Hierarchy 2000002	
	Order Code	Price £
80A B1 fuselink	ATC80	6.30
100A B1 fuselink	ATC100	6.30
125A B2 fuselink	ATF125	10.75
160A B2 fuselink	ATF160	11.80
200A B2 fuselink	ATF200	12.35
250A B3 fuselink	ATKF250	15.58
315A B3 fuselink	ATKF315	17.37
355A B4 fuselink	ATMF355	21.79
400A B4 fuselink	ATMF400	23.13
450A Fuselink Fixing Centre: 111	ATMF450	33.78
500A Fuselink Fixing Centre: 111	ATMF500	36.19
560A Fuselink Fixing Centre: 111	ATMF560	37.56
630A Fuselink Fixing Centre: 111	ATMF630	39.66
250A fuselink	ATKM250	15.58
315A fuselink	ATKM315	17.37
355A C1 fuselink	ATM355	21.79
400A C1 fuselink	ATM400	23.13
450A C2 fuselink	ATTM450	33.78
500A C2 fuselink	ATTM500	36.06
630A C2 fuselink	ATTM630	39.66
800A C3 fuselink	ATLM800	89.79
2A F1 fuselink	ANS2	1.38
4A F1 fuselink	ANS4	1.38
6A F1 fuselink	ANS6	1.38
10A F1 fuselink	ANS10	1.38
16A F1 fuselink	ANS16	1.38
20A F1 fuselink	ANS20	1.67
25A F1 fuselink	ANS25	1.97
20A F2 fuselink	AES20	2.17
25A F2 fuselink	AES25	2.61
32A F2 fuselink	AES32	2.61
40A F2 fuselink	AES40	2.89
50A F2 fuselink	AES50	3.36
63A F2 fuselink	AES63	3.82



Full range of product and technical information place this part number in a search engine and download
1SCC301001C0201

SlimLine XR

Switchfuses and Accessories

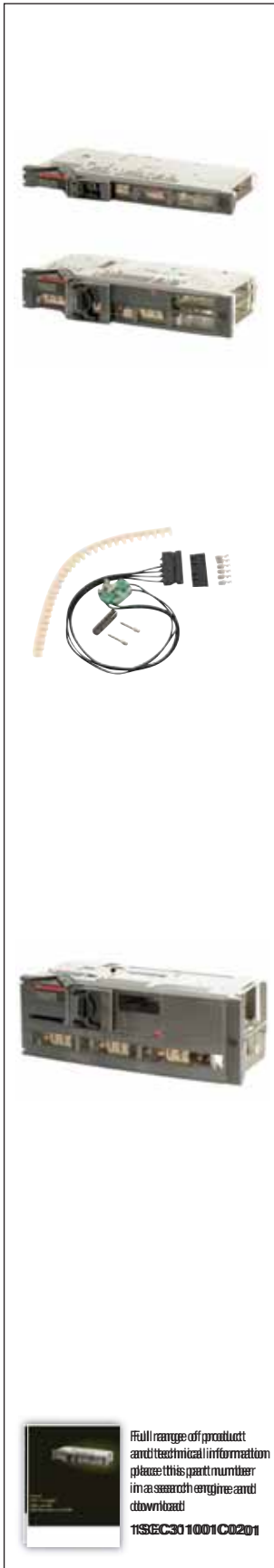

XR Switch Fuse 3-pole - 185mm busbar distance BS - British Standard

Description	Product Hierarchy 2300001	
	Order Code	Price
XR Slimline 63A 3P	1SEP102244R3300	198.90
XR Slimline 100A 3P	1SEP102245R3300	245.85
XR Slimline 160A 3P	1SEP102246R3300	332.44
XR Slimline 250A 3P	1SEP102247R3300	358.23
XR Slimline 400A 3P	1SEP102248R3300	660.19
XR Slimline 630A 3P	1SEP102249R3300	895.89
Accessories		
XR 50mm Ventilated Blind Cover	1SEP408528R0001	26.54
XR 00 Auxillary Switch 1NO	1SEP408504R0001	46.83
XR 00 Auxillary Switch 1NC	1SEP408505R0001	46.83
XR 1 Auxillary Switch 1NO	1SEP408506R0001	46.83
XR 1 Auxillary Switch 1NC	1SEP408507R0001	46.83
XR 2/3 Auxillary Switch 1NO	1SEP408508R0001	46.83
XR 2/3 Auxillary Switch 1NC	1SEP408509R0001	46.83
XR Single Auxillary Switch 1NO	1SEP407742R0013	7.70
XR 63A - 160A 3P Shroud Size 0	1SEP408496R0001	41.47
XR 250A 3P Shroud Size 1	1SEP408497R0001	48.72
XR 400A/630A Shroud Size 2/3	1SEP408498R0001	84.48

XR-E Switch fuse 4-pole - 185mm busbar distance BS - British Standard

Type designation	Product Hierarchy 2300001	
	Order Code	Price
160A BS 185mm 4 Pole AC23B	1SEP102246R3400	488.52
250A BS 185mm 4 Pole AC23B	1SEP102247R3400	582.90
400A BS 185mm 4 Pole AC23B	1SEP102248R3400	1179.90
630A BS 185mm 4 Pole AC23B	1SEP102249R3400	1201.47
Accessories		
63A - 160A Terminal Extension 3 pieces	1SEP408523R0001	96.46
250A Terminal Extension 3 pieces	1SEP408525R0001	100.23
4Pole Cable Shroud Size SR00-3	1SEP407775R0001	8.38
SRM Busbar Support	NHP 343139P0001	44.98



Full range of product and technical information please visit www.abb.com or search engine and download **1SECC31001C0201**

CamLine

Rotary Cam Switches



Srew mounting also available.

All switches available without an escutcheon & with a round front ring only, call sales for details or visit cam web design platform <https://a.saleconfigurator.com>. Alternatively see page 5 of the latest CamLine Catalogue 1SCC302003C0201



Full range of product and technical information place this part number in a search engine and download
1SCC302003C0201

Description	Product Hierarchy 4000003	
	Order Code	Price
10A 1P 0-1 Mini Cam Switch	OMA1PB	9.70
10A 2P 0-1 Mini Cam Switch	OMA2PB	9.81
10A 3P 0-1 Mini Cam Switch	OMA3PB	13.92
25A 2P 0-1 Mini Cam Switch	ONA2PB	10.43
25A 3P 0-1 Mini Cam Switch	ONA3PB	12.78
25A 1P On-Off switch, round front ring	ONA1XB	8.80
25A 2P On-Off switch, round front ring	ONA2XB	10.25
25A 3P On-Off switch, round front ring	ONA3XB	12.56
10A 1P 0-1 Mini Key Op Cam Switch	OMA1KB	23.79
10A 3P 0-1 Mini Key Op Cam Switch	OMA3KB	28.12
25A 3P Key Op C/O Cam switch, 1-0-2	ONU3KB	29.24
25A 1P C/O Cam sw/ rnd frnt rng, 1-2	ONWS1XB	12.04
25A 2P C/O Cam sw/ rnd frnt rng, 1-2	ONWS2XB	14.41
25A 3P C/O Cam sw/ rnd frnt rng, 1-2	ONWS3XB	19.53
10A 1P 1-0-2 Mini Changeover Cam switch	OMU1PB	9.81
10A 2P 1-0-2 Mini Changeover Cam switch	OMU2PB	13.40
10A 3P 1-0-2 Mini Changeover Cam switch	OMU3PB	17.01
25A 1P 1-0-2 Mini Changeover Cam switch	ONU1PB	10.43
25A 2P 1-0-2 Mini Changeover Cam switch	ONU2PB	14.30
25A 3P 1-0-2 Mini Changeover Cam switch	ONU3PB	18.13
10A 1P 1-2 Mini Changeover Cam switch	OMWS1PB	11.21
10A 3P 1-2 Mini Changeover Cam switch	OMWS3PB	20.33
10A 2P 1-2 Mini Changeover Cam switch	ONWS2PB	14.44
10A 3P 1-2 Mini Changeover Cam switch	ONWS3PB	18.80
25A 1P Key Op C/O Cam switch, 1-0-2	ONU1KB	28.12
10A 1P, 2 Step, Multistep Switch 0-1-2	OMSO21PB	9.81
10A 1P, 3 Step, Multistep Switch 0-1-2-3	OMSO31PB	11.97
10A 2P, 3 Step, Multistep Switch 0-1-2-3	OMSO32PB	17.01
25A 1P, 2 Step, Multistep Switch 0-1-2	ONSO21PB	10.43
25A 2P, 2 Step, Multistep Switch 0-1-2	ONSO22PB	14.30
25A 3P, 2 Step, Multistep Switch 0-1-2	ONSO23PB	23.79
25A 2P, 3 Step, Multistep Switch 0-1-2-3	ONSO32PB	18.13
25A 3P, 3 Step, Multistep Switch 0-1-2-3	ONSO33PB	24.30
25A 1P 4 Step Multistep Switch 1-2-3	ONSO41PB	14.30
25A 2P 4 Step Multistep Switch 1-2-3	ONSO42PB	29.60
25A 2P IP65 Enc 0-1 Cam Switch	ONA2EPB	17.20
25A 3P IP65 Enc 0-1 Cam Switch	ONA3EPB	19.32



Enclosures

SR Sheet Steel Enclosures IP65

98

Gemini Weather proof Enclosures IP66

99 - 102



Enclosures

IP65 Sheet Steel Enclosure



5

Solid Door Sheet Steel Enclosures IP65

Description H x W x D	Product Hierarchy 3200003	
	Order Code	Price
300 x 200 x 150	SRN3215K	38.26
300 x 300 x 150	SRN3315K	41.74
400 x 300 x 150	SRN4315K	47.01
400 x 300 x 200	SRN4320K	49.52
400 x 600 x 200	SRN4620K	78.36
500 x 300 x 200	SRN5320K	58.04
500 x 400 x 200	SRN5420K	64.43
500 x 400 x 250	SRN5425K	67.92
600 x 400 x 200	SRN6420K	78.36
600 x 400 x 250	SRN6425K	83.58
800 x 600 x 250	SRN8625K	136.99
600 x 600 x 250	SRN6625K	100.41
700 x 500 x 200	SRN7520K	100.41
700 x 500 x 250	SRN7525K	106.22
800 x 600 x 300	SRN8630K	145.69
800 x 800 x 300	SRN8830K	158.36
1000 x 600 x 250	SRN10625K	175.88
1000 x 600 x 300	SRN10630K	193.30
1000 x 800 x 300	SRN10830K	222.29
1200 x 600 x 300	SRN12630K	228.70
1200 x 800 x 300	SRN12830K	245.52

Glazed Door Sheet Steel Enclosures IP65

Description H x W x D	Product Hierarchy 3200003	
	Order Code	Price
500 x 400 x 200	SRN5420VK	86.48
500 x 400 x 250	SRN5425VK	90.55
600 x 400 x 200	SRN6420VK	103.90
600 x 400 x 250	SRN6425VK	109.71
800 x 600 x 250	SRN8625VK	163.10
700 x 500 x 200	SRN7520VK	121.07
700 x 500 x 250	SRN7525VK	127.69
800 x 600 x 250	SRN8625VK	163.10
800 x 600 x 300	SRN8630VK	184.00
1000 x 600 x 250	SRN10625VK	208.39
1000 x 600 x 300	SRN10630VK	225.80
1000 x 800 x 300	SRN10830VK	249.59
1200 x 600 x 300	SRN12630VK	255.40
1200 x 800 x 300	SRN12830VK	272.81

Accessories

Description	Product Hierarchy 3200003	
	Order Code	Price
Document pocket	AA5600	14.07
N.4 wall mounting brackets	AA1206	5.62
Lock with Yale insert & key	AA8002	13.93

Enclosures

IP66 Gemini Weather Proof Range

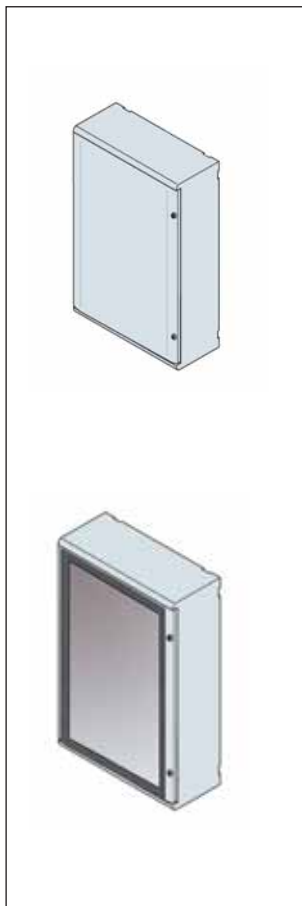
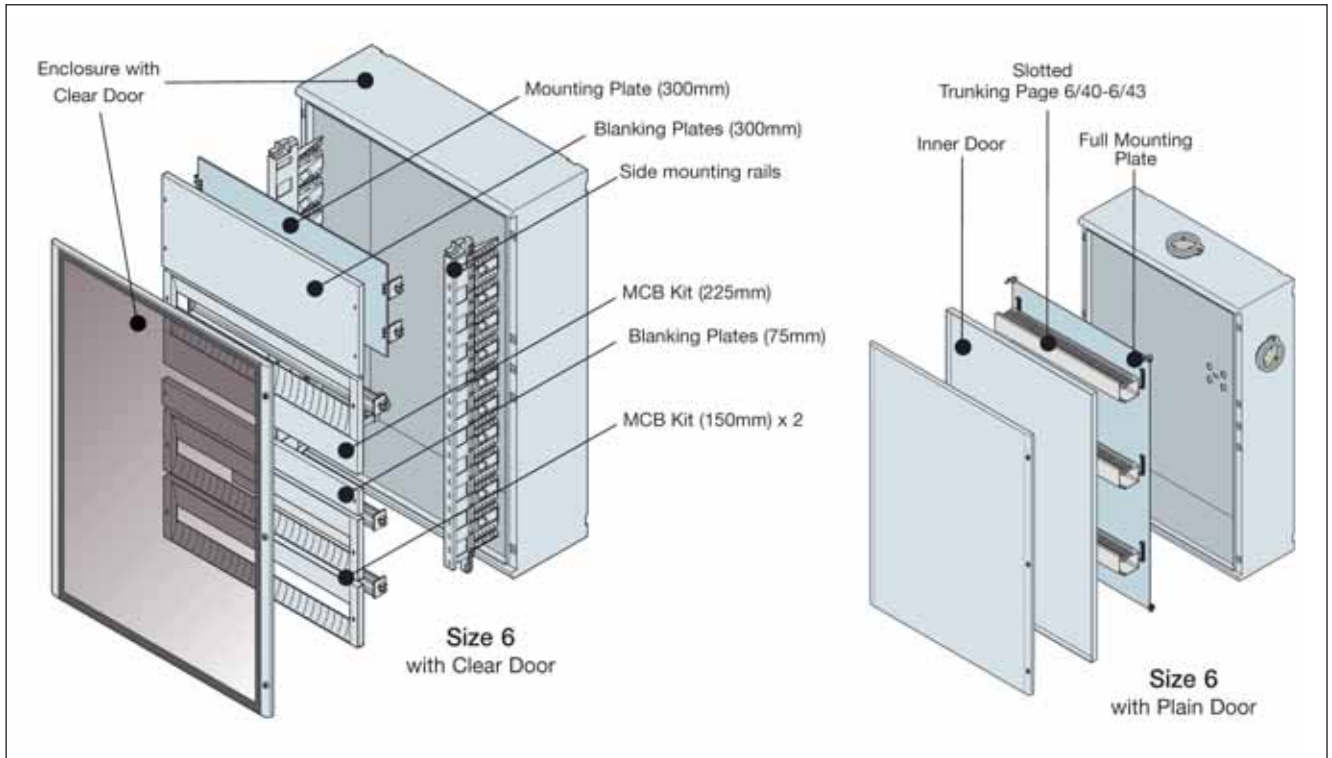

Gemini Enclosures

Components are suitable for any type and size of enclosure

Enclosure with Plain Door

Size HxWxD	Usable Height	Size	Product Hierarchy 3100007	
			Order Code	Price
400 x 335 x 210	300	1	1SL0201A00	79.42
550 x 460 x 260	450	2	1SL0202A00	121.19
700 x 460 x 260	600	3	1SL0203A00	153.85
700 x 590 x 260	600	4	1SL0204A00	182.94
855 x 590 x 360	750	5	1SL0205A00	275.01
1005 x 840 x 360	900	6	1SL0206A00	533.46

Enclosure with Plain Door

Size HxWxD	Usable Height	Size	Product Hierarchy 3100007	
			Order Code	Price
400 x 335 x 210	300	1	1SL0211A00	96.88
550 x 460 x 260	450	2	1SL0212A00	140.77
700 x 460 x 260	600	3	1SL0213A00	168.23
700 x 590 x 260	600	4	1SL0214A00	220.68
855 x 590 x 360	750	5	1SL0215A00	294.55
1005 x 840 x 360	900	6	1SL0216A00	566.52

Enclosures

IP66 Gemini Weather Proof Range

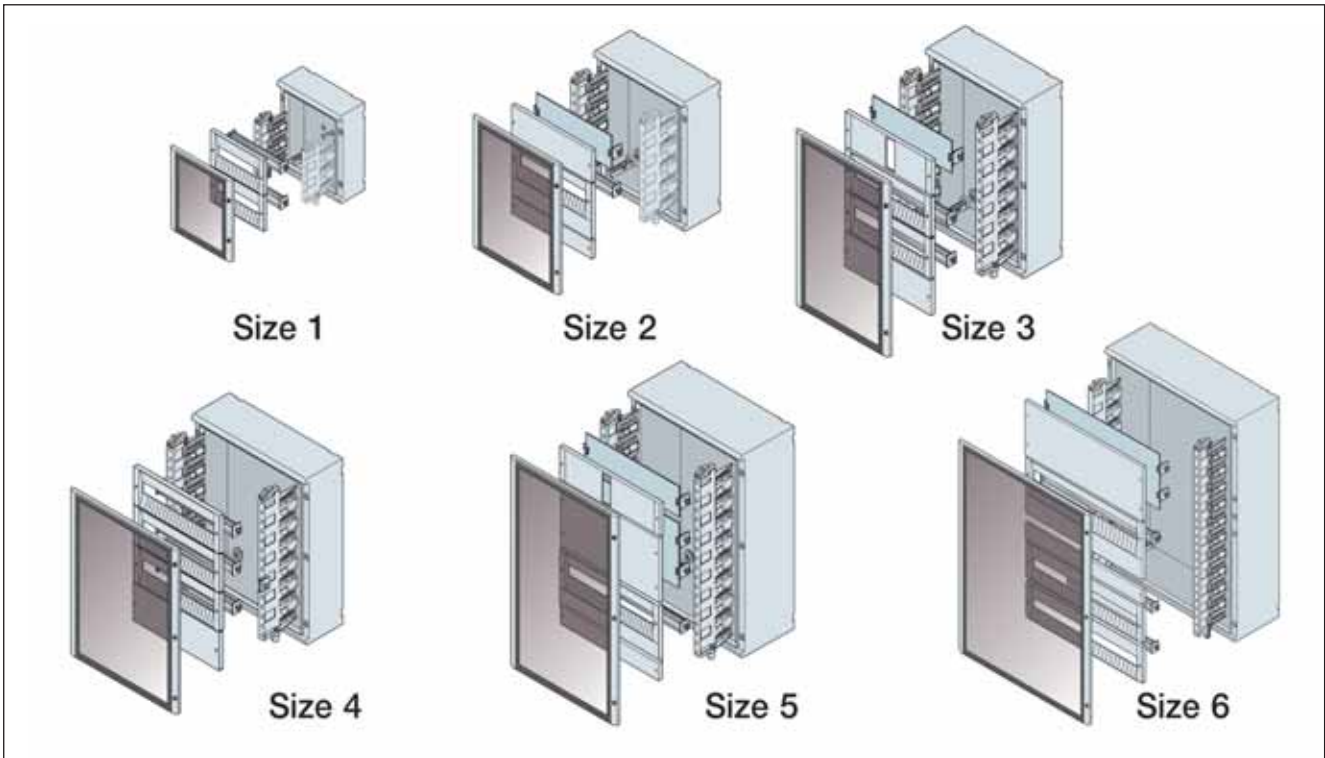

5

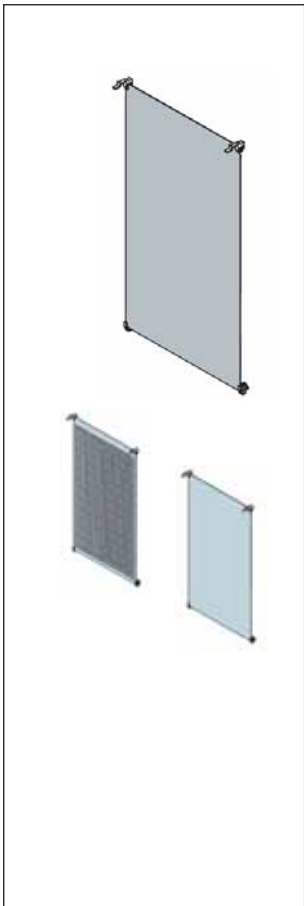

Full Mounting Plates

Size HxW	Size	Product Hierarchy 310007	
		Order Code	Price
285 x 235	1	1SL0259A00	8.37
435 x 360	2	1SL0260A00	13.00
585 x 360	3	1SL0261A00	17.69
585 x 485	4	1SL0262A00	23.16
735 x 485	5	1SL0263A00	33.51
885 x 735	6	1SL0264A00	64.64

Also available:

- Perforated Mounting Plates suitable for use with floating nuts.
- Insulated Mounting Plates.

Please consult us for availability

Enclosures

IP66 Gemini Weather Proof Range



Mounting Plates

Product Hierarchy 3100007

Size HxW	Nominal Size	Size	Order Code	Price £
130 x 210	150	1	1SL0296A00	6.44
130 x 318	150	2	1SL0297A00	8.37
130 x 318	150	3	1SL0297A00	8.37
130 x 443	150	4	1SL0298A00	11.09
130 x 443	150	5	1SL0298A00	11.09
130 x 663	150	6	1SL0299A00	20.25

280 x 318	300	2	1SL0302A00	16.87
280 x 318	300	3	1SL0302A00	16.87
280 x 443	300	4	1SL0303A00	20.96
280 x 443	300	5	1SL0303A00	20.96
280 x 663	300	6	1SL0304A00	37.00

Side Mounting Rails

Product Hierarchy 3100007

Size H	Size	Order Code	Price £
300	1	1SL0283A00	10.06
450	2	1SL0284A00	10.75
600	3	1SL0285A00	13.54
600	4	1SL0285A00	13.54
750	5	1SL0286A00	16.32
900	6	1SL0287A00	25.53

MCB Kits

Product Hierarchy 3100007

Size HxW	Modules	Size	Order Code	Price £
150 x 250	12	1	1SL0307A00	11.52
150 x 375	18	2	1SL0308A00	12.83
150 x 375	18	3	1SL0308A00	12.83
150 x 500	24	4	1SL0309A00	15.97
150 x 500	24	5	1SL0309A00	15.97
150 x 750	36	6	1SL0310A00	21.09

225 x 375	2	18	1SL0313A00	17.35
225 x 375	3	18	1SL0313A00	17.35
225 x 500	4	24	1SL0314A00	21.55
225 x 500	5	24	1SL0314A00	21.55
225 x 750	6	36	1SL0315A00	28.48

Enclosures

IP66 Gemini Weather Proof Range



Blanking Plates

		Product Hierarchy 3100007	
Size HxW	Size	Order Code	Price £
150 x 250	1	1SL0324A00	9.50
150 x 375	2	1SL0325A00	10.83
150 x 375	3	1SL0325A00	10.83
150 x 500	4	1SL0326A00	12.71
150 x 500	5	1SL0326A00	12.71
150 x 750	6	1SL0327A00	14.22

Accessories

		Product Hierarchy 3100007	
Description	Size	Order Code	Price £
Key lock and handle	Fits All	1SL0340A00	9.71
Square lock	Fits All	1SL0339A00	1.35
Wall mounting brackets (4off)	Fits All	1SL0342A00	5.72

Contents

Feed Through Terminal Blocks	104
Mini Feed Through & Fuse Terminal Blocks.....	112 - 113
Double Deck Terminals	114 - 120
Triple Deck Terminals	121
Disconnect Terminals	122 - 125
Power Terminals.....	126 - 127
Security Terminals	128
Fuse Terminals	129
Distribution Blocks.....	132
General Accessories.....	133
Spring Clamp Terminal Blocks	134 - 141
SNK Terminal Blocks.....	142 - 154
ADO Terminal Blocks	155 - 160
Marker Cards	161 - 163



5000 Series



Full range of product and technical information place this part number in a search engine and download
1SNC160001C0207

SNK Series



Full range of product and technical information place this part number in a search engine and download
1SNK161001C0201

Terminals & Connectors

Feed Through Terminal Blocks



Feed Through Terminal Blocks 2.5mm ²		Product Hierarchy 300002	
Type	Description	Order Code	Price
MA2,5/5	2.5mm ² feed through terminal (Grey)	1SNA115486R0300	0.49
MA2,5/5.N	2.5mm ² feed through terminal (Blue)	1SNA125486R0500	0.63
MA2,5/5.P	2.5mm ² feed through terminal, Ground (Green/Yellow)	1SNA165488R2700	2.13
MA2,5/5.V0	2.5mm ² feed through terminal (Beige) V0	1SNA195486R0400	0.66
MA2,5/5	2.5mm ² feed through terminal (White)	1SNA105052R2100	0.63
MA2,5/5	2.5mm ² feed through terminal (Yellow)	1SNA105486R1200	0.49
MA2,5/5.1	2.5mm ² feed through terminal with partition (Grey)	1SNA115485R0200	0.53

Accessories		Product Hierarchy 300008	
Type	Description	Order Code	Price
FEM6	End section 2.5mm ² - 10mm ² (Grey)	1SNA118368R1600	0.23
FEM6	End section 2.5mm ² - 10mm ² (Blue)	1SNA128368R1000	0.29
FEM6	End section 2.5mm ² - 10mm ² (Yellow)	1SNA103062R2100	0.23
FEM6	End section 2.5mm ² - 10mm ² (Green)	1SNA103125R1500	0.29
FEM6	End section 2.5mm ² - 10mm ² (Orange)	1SNA103126R1600	0.29
FEM6	End section 2.5mm ² - 10mm ² (White)	1SNA103312R2000	0.18
FEM6 V0	End section 2.5mm ² - 10mm ² (Beige) V0	1SNA198368R1700	0.36
FEM61	End section 2.5mm ² - 10mm ² (Grey) snaps onto dinrail	1SNA114776R2300	0.43
FEM6C	Circuit separator 2.5mm ² - 10mm ² (Grey) snaps onto dinrail, for CPM cover	1SNA114777R2400	0.44
SCMA5	Circuit separator 2.5mm ² - 10mm ² (Grey) fits into top of terminal	1SNA116728R2500	0.23
SCF6	Separator end section 2.5mm ² - 10mm ² (Grey) for CPM cover	1SNA118707R0300	0.34
SCF61	Separator end section 2.5mm ² - 10mm ² (Grey)	1SNA114202R2500	0.58
SCFM6	Separator end section 2.5mm ² - 10mm ² (Grey) snaps onto dinrail, for CPM cover	1SNA114825R0500	0.48
SCFCV1-2	Separator end section (Grey) for CPV cover	1SNA116795R1100	1.39
BJMI5	Jumper bar - 2 pole (IP20)	1SNA176278R1600	1.04
BJMI5	Jumper bar - 3 pole (IP20)	1SNA176279R1700	1.15
BJMI5	Jumper bar - 4 pole (IP20)	1SNA176280R0500	1.34
BJMI5	Jumper bar - 5 pole (IP20)	1SNA176281R2200	1.71
BJMI5	Jumper bar - 10 pole (IP20)	1SNA176282R2300	2.86
EL6	Connector plate for linking two jumper bars together	1SNA173627R2100	0.22
PC5	Comb jumper bar - 10 poles	1SNA113544R1200	1.35
EIP	Insulating tip for comb jumper bar	1SNA113550R2400	0.19
CPM	Protective cover (Clear) 0.5 metres	1SNA187312R1400	2.13
CPV1-2	Protective cover (Clear) 1 metre	1SNA176816R1200	8.98
AL2	Test socket 2mm dia.	1SNA163043R2100	0.21



Full range of product and technical information place this part number in a search engine and download
1SNC160001C0207

Terminal & Connectors

Feed Through Terminal Blocks

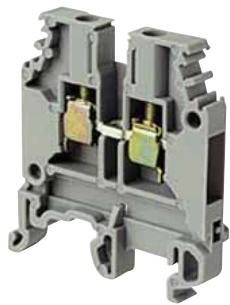

Full range of product and technical information place this part number in a search engine and download
1SNC160001C0207

Accessories

		Product Hierarchy 300008	
Type	Description	Order Code	Price
CBM5	Screen bar 0.5mm thickness	1SNA178745R1400	0.34
CBM8	Screen bar 0.8mm thickness	1SNA178746R1500	0.43
EPU5	Yellow protection label (strip of 12 labels)	1SNA107033R1000	2.80

Feed Through Terminal Blocks 4.0mm²

		Product Hierarchy 300002	
Type	Description	Order Code	Price
M4/6	4.0mm² feed through terminal (Grey)	1SNA115116R0700	0.49
M4/6	4.0mm² feed through terminal (Blue)	1SNA125116R0100	0.63
M4/6.P	4.0mm² feed through terminal, Ground screws onto dinrail (Green/Yellow)	1SNA165113R1600	2.08
D4/6.P	4.0mm² feed through terminal, Ground snaps onto dinrail (Green/Yellow)	1SNA165809R0100	1.87
M4/6	4.0mm² feed through terminal (Green)	1SNA105001R2700	0.63
M4/6	4.0mm² feed through terminal (Orange)	1SNA105002R2000	0.49
M4/6	4.0mm² feed through terminal (Black)	1SNA105031R1400	0.49
M4/6	4.0mm² feed through terminal (Red)	1SNA105032R1500	0.49
M4/6	4.0mm² feed through terminal (White)	1SNA105051R2000	0.63
M4/6	4.0mm² feed through terminal (Yellow)	1SNA105116R1600	0.49
M4/6	4.0mm² feed through terminal (Brown)	1SNA105209R1400	0.49
M4/6 V0	4.0mm² feed through terminal (Beige) V0	1SNA195116R0000	0.66
M4/6.1	4.0mm² feed through terminal with partition (Grey)	1SNA115259R0600	0.69
M4/6.C	4.0mm² feed through terminal with partition and 2.5mm dia. test socket (Grey)	1SNA115208R0400	1.24
M4/6.3A	4.0mm² feed through terminal (3 screw clamps) (Grey)	1SNA115468R2000	1.00
M4/6.3A	4.0mm² feed through terminal (3 screw clamps) (Blue)	1SNA125468R2200	1.44
M4/6.3A.P	4.0mm² feed through terminal, (3 screw clamps) Ground (Green/Yellow)	1SNA195637R1200	2.78
M4/6.3A.1	4.0mm² feed through terminal with partition (3 screw clamps) (Grey)	1SNA115483R0000	1.42
M4/6.4A	4.0mm² feed through terminal (4 screw clamps) (Grey)	1SNA115479R2300	1.17
M4/6.4A	4.0mm² feed through terminal (4 screw clamps) (Blue)	1SNA125479R2500	1.70
M4/6.4A.P	4.0mm² feed through terminal, (4 screw clamps) Ground (Green/Yellow)	1SNA195638R2300	3.15
MS4/6	4.0mm² compact feed through terminal (Grey)	1SNA115265R2400	0.52

Accessories

FEM6	End section 2.5mm² - 10mm² (Grey)	1SNA118368R1600	0.23
FEM6	End section 2.5mm² - 10mm² (Blue)	1SNA128368R1000	0.29
FEM6	End section 2.5mm² - 10mm² (Yellow)	1SNA103062R2100	0.23
FEM6	End section 2.5mm² - 10mm² (Green)	1SNA103125R1500	0.29
FEM6	End section 2.5mm² - 10mm² (Orange)	1SNA103126R1600	0.29
FEM6	End section 2.5mm² - 10mm² (White)	1SNA103312R2000	0.18
FEM6 V0	End section 2.5mm² - 10mm² (Beige) V0	1SNA198368R1700	0.36
FEM3A	End section for M4/6.3A Series (Grey)	1SNA116576R1500	0.24
FEM3AP	End section for M4/6.3A.P (Green)	1SNA199876R2600	0.24
FEM4A	End section for M4/6.4A (Grey)	1SNA116629R2200	0.25
FEM4AP	End section for M4/6.4A.P (Green)	1SNA199879R0100	0.24

Terminal & Connectors

Feed Through Terminal Blocks



Accessories		Product Hierarchy 300008	
Type	Description	Order Code	Price
FEMS6	Compact end section for MS4/6 (Grey)	1SNA113885R0100	0.25
FEM6C	Circuit separator 2.5mm ² - 10mm ² (Grey) snaps onto dinrail, for CPM cover	1SNA114777R2400	0.44
SCMA5	Circuit separator 2.5mm ² - 10mm ² (Grey) fits into top of terminal	1SNA116728R2500	0.23
SCF6	Separator end section 2.5mm ² - 10mm ² (Grey) for CPM cover	1SNA118707R0300	0.34
SCF61	Separator end section 2.5mm ² - 10mm ² (Grey)	1SNA114202R2500	0.58
SCFM6	Separator end section 2.5mm ² - 10mm ² (Grey) snaps onto Dinrail, for CPM cover	1SNA114825R0500	0.48
SCFCV1-2	Separator end section (Grey) for CPV cover	1SNA116795R1100	1.39
BJMI6	Jumper bar - 2 pole (IP20)	1SNA176663R0000	0.52
BJMI6	Jumper bar - 3 pole (IP20)	1SNA176664R0100	0.76
BJMI6	Jumper bar - 4 pole (IP20)	1SNA176665R0200	0.96
BJMI6	Jumper bar - 5 pole (IP20)	1SNA176666R0300	1.29
BJMI6	Jumper bar - 10 pole (IP20)	1SNA176667R0400	3.34
EL6	Connector plate for linking two jumper bars together	1SNA173627R2100	0.22
PC6	Comb jumper bar - 2 pole for MS4/6 compact terminal	1SNA113546R1400	0.98
PC6	Comb jumper bar - 10 pole for MS4/6 compact terminal	1SNA113548R2600	1.43
EIP	Insulating tip for comb jumper bar	1SNA113550R2400	0.19
CPM	Protective cover (Clear) 0.5 metres	1SNA187312R1400	2.13
CPV1-2	Protective cover (Clear) 1 metre	1SNA176816R1200	8.98
AL2	Test socket 2mm dia.	1SNA163043R2100	0.21
FC2	Test plug 2mm diameter	1SNA007865R2600	1.21
CBM5	Screen bar 0.5mm thickness	1SNA178745R1400	0.34
CBM8	Screen bar 0.8mm thickness	1SNA178746R1500	0.43
EP6	Protection label for 4 x 6mm pitch blocks	1SNA163427R1700	0.91
VSP6	Nylon screw for EP6 label	1SNA163433R1500	0.11
EPU6	Yellow protection label (strip of 12 labels)	1SNA107038R2500	2.80

6



Full range of product and technical information place this part number in a search engine and download
1SNC160001C0207

Terminal & Connectors

Feed Through Terminal Blocks



Feed Through Terminal Blocks 6.0mm²		Product Hierarchy 300002	
Type	Description	Order Code	Price
M6/8	6.0mm² feed through terminal (Grey)	1SNA115118R1100	0.72
M6/8.N	6.0mm² feed through terminal (Blue)	1SNA125118R1300	0.83
M6/8.P	6.0mm² feed through terminal, Earth (Green/Yellow)	1SNA165114R1700	2.38
M6/8	6.0mm² feed through terminal (Yellow)	1SNA105118R2000	0.72
M6/8.V0	6.0mm² feed through terminal (Beige) V0	1SNA195118R1200	0.84
M6/8.1	6.0mm² feed through terminal with partition (Grey)	1SNA115260R0300	0.88
M6/8.4	6.0mm² feed through terminal with partition and 4mm dia. test socket (Grey)	1SNA115219R2600	1.12

Accessories		Product Hierarchy 300008	
Type	Description	Order Code	Price
FEM6	End section 2.5mm² - 10mm² (Grey)	1SNA118368R1600	0.23
FEM6	End section 2.5mm² - 10mm² (Blue)	1SNA128368R1000	0.29
FEM6	End section 2.5mm² - 10mm² (Yellow)	1SNA103062R2100	0.23
FEM6	End section 2.5mm² - 10mm² (Green)	1SNA103125R1500	0.29
FEM6	End section 2.5mm² - 10mm² (Orange)	1SNA103126R1600	0.29
FEM6	End section 2.5mm² - 10mm² (White)	1SNA103312R2000	0.18
FEM6 V0	End section 2.5mm² - 10mm² (Beige) V0	1SNA198368R1700	0.36
FEM6C	Circuit separator 2.5mm² - 10mm² (Grey) snaps onto dinrail, for CPM cover	1SNA114777R2400	0.44
SCMA5	Circuit separator 2.5mm² - 10mm² (Grey) fits into top of terminal	1SNA116728R2500	0.23
SCF6	Separator end section 2.5mm² - 10mm² (Grey) for CPM cover	1SNA118707R0300	0.34
SCF61	Separator end section 2.5mm² - 10mm² (Grey)	1SNA114202R2500	0.58
SCFM6	Separator end section 2.5mm² - 10mm² (Grey) snaps onto dinrail, for CPM cover	1SNA114825R0500	0.48
SCFCV1-2	Separator end section (Grey) for CPV cover	1SNA116795R1100	1.39
BJM18	Jumper bar - 2 pole (IP20)	1SNA176669R1600	0.82
BJM18	Jumper bar - 3 pole (IP20)	1SNA176670R1300	1.19
BJM18	Jumper bar - 4 pole (IP20)	1SNA176671R0000	1.53
BJM18	Jumper bar - 5 pole (IP20)	1SNA176672R0100	1.91
BJM18	Jumper bar - 10 pole (IP20)	1SNA176673R0200	3.47
EL6	Connector plate for linking two jumper bars together	1SNA173627R2100	0.22
PC8	Comb jumper bar - 10 pole	1SNA163313R2400	1.95
CPM	Protective cover (Clear) 0.5 metres	1SNA187312R1400	2.13
CPV1-2	Protective cover (Clear) 1 metre	1SNA176816R1200	8.98
AL2	Test socket 2mm dia.	1SNA163043R2100	0.21
AL4	Test socket 4mm dia.	1SNA163262R0100	0.20



Full range of product and technical information place this part number in a search engine and download
1SNC160001C0207

Terminal & Connectors

Feed Through Terminal Blocks



Accessories		Product Hierarchy 300008	
Type	Description	Order Code	Price
FC2	Test plug 2mm diameter	1SNA007865R2600	1.21
CBM5	Screen bar 0.5mm thickness	1SNA178745R1400	0.34
CBM8	Screen bar 0.8mm thickness	1SNA178746R1500	0.43
EP6	Protection label for 3 x 8mm pitch blocks	1SNA163427R1700	0.91
EP8	Protection label for 4 x 8mm pitch blocks	1SNA163428R2000	1.03
VSP6	Nylon screw for EP6 / EP8 Label	1SNA163433R1500	0.11
EPU6	Yellow protection label (strip of 12 labels)	1SNA107038R2500	2.80

Feed Through Terminal Blocks 10.0mm ²		Product Hierarchy 300002	
Type	Description	Order Code	Price
M10/10	10.0mm ² feed through terminal (Grey)	1SNA115120R1700	0.88
M10/10.N	10.0mm ² feed through terminal (Blue)	1SNA125120R1100	1.41
M10/10.P	10.0mm ² feed through terminal, Ground (Green/Yellow)	1SNA165115R1000	2.52
M10/10	10.0mm ² feed through terminal (Yellow)	1SNA105120R2600	1.41
M10/10.VO	10.0mm ² feed through terminal (Beige) VO	1SNA195120R1000	1.02
M10/10.VO	10.0mm ² feed through terminal (Blue) VO	1SNA199004R2000	1.49
M10/10	10.0mm ² feed through terminal (Black)	1SNA400188R0300	0.88
M10/10	10.0mm ² feed through terminal (Red)	1SNA400189R0400	0.88
M10/10.1	10.0mm ² feed through terminal with partition (Grey)	1SNA115261R2000	1.12

Accessories		Product Hierarchy 300008	
Type	Description	Order Code	Price
FEM6	End section 2.5mm ² - 10mm ² (Grey)	1SNA118368R1600	0.23
FEM6	End section 2.5mm ² - 10mm ² (Blue)	1SNA128368R1000	0.29
FEM6	End section 2.5mm ² - 10mm ² (Yellow)	1SNA103062R2100	0.23
FEM6	End section 2.5mm ² - 10mm ² (Green)	1SNA103125R1500	0.29
FEM6	End section 2.5mm ² - 10mm ² (Orange)	1SNA103126R1600	0.29
FEM6	End section 2.5mm ² - 10mm ² (White)	1SNA103312R2000	0.18
FEM6 VO	End section 2.5mm ² - 10mm ² (Beige) VO	1SNA198368R1700	0.36
FEM6C	Circuit separator 2.5mm ² - 10mm ² (Grey) snaps onto dinrail, for CPM cover	1SNA114777R2400	0.44
SCMA5	Circuit separator 2.5mm ² - 10mm ² (Grey) fits into top of terminal	1SNA116728R2500	0.23
SCF6	Separator end section 2.5mm ² - 10mm ² (Grey) for CPM cover	1SNA118707R0300	0.34
SCF61	Separator end section 2.5mm ² - 10mm ² (Grey)	1SNA114202R2500	0.58
SCFM6	Separator end section 2.5mm ² - 10mm ² (Grey) snaps onto dinrail, for CPM cover	1SNA114825R0500	0.48
SCFCV1-2	Separator end section (Grey) for CPV cover	1SNA116795R1100	1.39
CPM	Protective cover (Clear) 0.5 metres	1SNA187312R1400	2.13
CPV1-2	Protective cover (Clear) 1 metre	1SNA176816R1200	8.98



Full range of product and technical information place this part number in a search engine and download

1SNC160001C0207

Terminal & Connectors

Feed Through Terminal Blocks



Accessories		Product Hierarchy 300008	
Type	Description	Order Code	Price
AL2	Test socket 2mm diameter	1SNA163043R2100	0.21
AL4	Test socket 4mm diameter	1SNA163262R0100	0.20
FC2	Test plug 2mm diameter	1SNA007865R2600	1.21
BJM10	Jumper bar - 2 pole (IP20)	1SNA176675R0400	0.74
BJM10	Jumper bar - 3 pole (IP20)	1SNA176676R0500	1.08
BJM10	Jumper bar - 4 pole (IP20)	1SNA176677R0600	1.64
BJM10	Jumper bar - 5 pole (IP20)	1SNA176678R1700	1.95
BJM10	Jumper bar - 10 pole (IP20)	1SNA176679R1000	3.96
PC10	Comb jumper bar - 10 pole	1SNA163315R2600	2.79
EP8	Protection label for 3 x 10mm blocks	1SNA163428R2000	1.03
VSP6	Nylon screw for EP8 label	1SNA163433R1500	0.11
EPU6	Yellow protection label (strip of 12 labels)	1SNA107038R2500	2.80

Feed Through Terminal Blocks 16.0mm ²		Product Hierarchy 300002	
Type	Description	Order Code	Price
M16/12	16.0mm ² feed through terminal (Grey)	1SNA115129R1400	1.26
M16/12.N	16.0mm ² feed through terminal (Blue)	1SNA125129R1600	1.59
M16/12.P	16.0mm ² feed through terminal, Ground (Green/Yellow)	1SNA165130R2300	3.58
M16/12.V0	16.0mm ² feed through terminal (Beige) V0	1SNA195129R1500	1.45

Accessories		Product Hierarchy 300008	
Type	Description	Order Code	Price
FEM12	End section 16mm ² (Grey)	1SNA118618R0100	0.48
FEM12	End section 16mm ² (Blue)	1SNA128618R0300	0.33
FEM12	End section 16mm ² (Yellow)	1SNA103065R2400	0.37
FEM12 V0	End section 16mm ² (Beige) V0	1SNA198618R0200	0.53
SCF12	Separator end section 16mm ² (grey) for CPM cover	1SNA113102R1000	0.61
SCF12V0	Separator end section 16mm ² (beige) V0	1SNA193102R1100	0.72
SCFCV1-2	Separator end section (Grey) for CPV cover	1SNA116795R1100	1.39
CPM	Protective cover (Clear) 0.5 metres	1SNA187312R1400	2.13
CPV1-2	Protective cover (Clear) 1 metre	1SNA176816R1200	8.98

6

Terminal & Connectors

Feed Through Terminal Blocks



Full range of product and technical information place this part number in a search engine and download
1SNC160001C0207

Accessories		Product Hierarchy 300008	
Type	Description	Order Code	Price
AL2	Test socket 2mm diameter	1SNA163043R2100	0.21
AL4	Test socket 4mm diameter	1SNA163262R0100	0.20
FC2	Test plug 2mm diameter	1SNA007865R2600	1.21
BJMI12	Jumper bar - 2 pole (IP20)	1SNA179626R0600	1.08
BJMI12	Jumper bar - 3 pole (IP20)	1SNA179628R1000	1.57
BJMI12	Jumper bar - 4 pole (IP20)	1SNA179629R1100	2.17
BJMI12	Jumper bar - 5 pole (IP20)	1SNA179630R1600	3.22
BJMI12	Jumper bar - 10 pole (IP20)	1SNA179631R0300	4.93
EPU6	Yellow protection label (strip of 12 labels)	1SNA107038R2500	2.80

Feed Through Terminal Blocks 35.0mm ²		Product Hierarchy 300002	
Type	Description	Order Code	Price
M35/16	35.0mm ² feed through terminal (Grey)	1SNA115124R0700	2.18
M35/16.V0	35.0mm ² feed through terminal (Beige) V0	1SNA195124R0000	3.09
M35/16.N	35.0mm ² feed through terminal (Blue)	1SNA125124R0100	2.53
M35/16.P	35.0mm ² feed through terminal, Ground (Green/Yellow)	1SNA165111R1400	4.50

Accessories - feed through terminals are enclosed no end section required		Product Hierarchy 300008	
Type	Description	Order Code	Price
SCFT1	Separator end section (grey)	1SNA103588R2600	0.95
SCFCV1-2	Separator end section (Grey) for CPV cover	1SNA116795R1100	1.39
CPV1-2	Protective cover (Clear) 1 metre	1SNA176816R1200	8.98
AL4	Test socket 4mm diameter	1SNA163262R0100	0.20
FC2	Test plug 2mm diameter	1SNA007865R2600	1.21
BJMI16	Jumper bar - 2 pole (IP20)	1SNA206217R0000	1.39
BJMI16	Jumper bar - 3 pole (IP20)	1SNA206218R1100	1.39
BJMI16	Jumper bar - 4 pole (IP20)	1SNA206219R1200	2.52
BJMI16	Jumper bar - 5 pole (IP20)	1SNA206220R1700	3.17
BJMI16	Jumper bar - 10 pole (IP20)	1SNA206221R0400	6.06

Terminal & Connectors

Feed Through Terminal Blocks



Feed Through Terminal Blocks 70.0mm²

Product Hierarchy
300002

Type	Description	Order Code	Price
M70/22	70.0mm² feed through terminal (Grey)	1SNA115216R1300	7.96
M70/22.N	70.0mm² feed through terminal (Blue)	1SNA125216R1500	8.45
M70/22.V0	70.0mm² feed through terminal (Beige) V0	1SNA195216R1400	16.22
M70/22.P	70.0mm² feed through terminal, Ground (Green/Yellow) closed	1SNA399024R2300	15.87

Accessories - feed through terminals are enclosed no end section required

Product Hierarchy
300008

Type	Description	Order Code	Price
FEM22	End section 70mm² (Grey)	1SNA113065R1500	1.12
FEM22	End section 70mm² (Blue)	1SNA123065R1700	1.15
FEM22	End section 70mm² (Yellow)	1SNA103881R1400	1.10
FEM22 V0	End section 70mm² (Beige) V0	1SNA193065R1600	1.32
SCF22	Separator end section (grey)	1SNA113851R1600	1.80

BJS22	Unassembled jumper bar - 2 pole	1SNA173316R2100	2.28
BJS22	Unassembled jumper bar - 3 pole	1SNA173317R2200	2.81
BJS22	Unassembled jumper bar - 10 pole	1SNA173319R0400	6.76
VSJ51	Screw for BJS 22 jumper bar	1SNA173320R0100	0.20
RDJ51	Washer for BJS22 jumper bar	1SNA173331R2000	0.05

Feed Through Terminal Blocks 95.0mm²

Product Hierarchy
300002

Type	Description	Order Code	Price
M95/26	95.0mm² feed through terminal (Grey)	1SNA115556R1000	12.10
M95/26.N	95.0mm² feed through terminal (Blue)	1SNA125556R1200	12.10
M95/26.P	95.0mm² feed through terminal, Ground (Green/Yellow) closed	1SNA399176R0000	22.67
M95/26.V0	95.0mm² feed through terminal (Beige) V0	1SNA195556R1100	11.51

Accessories

Product Hierarchy
300008

Type	Description	Order Code	Price
BJS261	Unassembled jumper bar - 2 pole	1SNA177508R0700	3.21
BJS261	Unassembled jumper bar - 10 pole	1SNA177511R1100	14.97
VSJ51	Screw for BJS 22 jumper bar	1SNA173320R0100	0.20
RDJ51	Washer for BJS22 jumper bar	1SNA173331R2000	0.05



Full range of product and technical information place this part number in a search engine and download

1SNC160001C0207

Terminal Blocks

Mini Feed Through & Fuse Terminal Blocks



1.5mm ² Mini Feed Through Terminal Blocks		Product Hierarchy 300002	
Type	Description	Order Code	Price
DR1,5/5.1	1.5mm ² mini feed through terminal with partition (grey)	1SNA112086R0200	0.83

Accessories		Product Hierarchy 300008	
Type	Description	Order Code	Price
FEDR5	End Section for 1.5mm ² mini terminal	1SNA117318R2300	0.23
BJS5	Unassembled jumper bar - 20 pole	1SNA177652R0600	2.16
EVD5	Post and screw for BJS5 jumper	1SNA167900R0200	0.28
FC2	Test Plug 2mm ² diameter	1SNA007865R2600	1.21

4.00mm ² Mini Feed Through Terminal Blocks		Product Hierarchy 300002	
Type	Description	Order Code	Price
DR4/6	4.0mm ² feed through terminal (Grey)	1SNA110251R0500	0.73
DR4/6.1	4.0mm ² feed through terminal with partition (Grey)	1SNA110491R1700	0.53
DR4/6.1.N	4.0mm ² feed through terminal with partition (Blue)	1SNA120491R1100	0.69
DR4/6.P	4.0mm ² feed through terminal block, Ground (Green / Yellow)	1SNA160496R2600	1.80

Accessories		Product Hierarchy 300008	
Type	Description	Order Code	Price
FEDR61	End section for DR4/6 & DR4/6.1 terminal (Grey)	1SNA117600R0300	0.22
FEDR61	End section for DR4/6 & DR4/6.1 terminal (Blue)	1SNA127600R0500	0.22
FEDR63	End section for DR4/6.P terminal (Yellow)	1SNA103975R2100	0.31
SCDR61	Separator end section for DR4/6 & DR4/6.1 terminals (Grey)	1SNA173016R1000	0.18
BJM62	Jumper bar - 2 pole for DR4/6 terminal	1SNA173217R2600	0.79
BJM62	Jumper bar - 4 pole for DR4/6 terminal	1SNA173219R0000	1.42
BJM62	Jumper bar - 10 pole for DR4/6 terminal	1SNA173226R2700	3.37



Full range of product and technical information place this part number in a search engine and download
1SNC160001C0207

Terminal Blocks

Mini Feed Through & Fuse Terminal Blocks



4.00mm ² Mini Fuse Terminal Blocks		Product Hierarchy 300002	
Type	Description	Order Code	Price
DR4/8.SF	Fuse terminal (flip top) for 5x20, 5x25mm fuse (Grey)	1SNA110368R1200	2.63
Accessories		Product Hierarchy 300008	
Type	Description	Order Code	Price
FEM8S	End section for DR4/8.SF fuse terminal (Grey)	1SNA116951R1500	0.36
PC81	Comb jumper bar - 10 pole	1SNA173523R1100	2.42
TGA8	Assembly rod, 2 pole, to link flip top fuse terminals DR4/8.SF	1SNA168672R1100	0.56
ANT	Assembly ring locks TGA8 in place on flip top fuse terminals DR4/8.SF	1SNA168675R1400	0.06
FU520	5 x 20mm 250V 0.5A fuse	1SNA008288R1500	0.41
FU520	5 x 20mm 250V 1A fuse	1SNA008290R1300	0.41
FU520	5 x 20mm 250V 2A fuse	1SNA008291R0000	0.41
FU520	5 x 20mm 250V 3.15A fuse	1SNA008289R1600	0.41
FU520	5 x 20mm 250V 5A fuse	1SNA008292R0100	0.41
FU525	5 x 25mm 250V 2.5A fuse	1SNA167548R0400	3.57
FU525	5 x 25mm 250V 4A fuse	1SNA167549R0500	0.36
CN5	5 x 25mm neutral bar	1SNA179371R1600	0.30

Terminal Blocks

Double Deck Feed Through Terminals

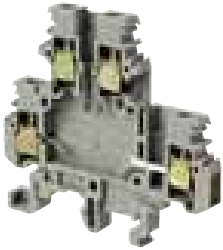

2.5mm ² Double Deck Terminal Block		Product Hierarchy 300002	
Type	Description	Order Code	Price
MA2,5/5.D2	2.5mm ² feed through terminal (Grey)	1SNA115490R1300	1.36
MA2,5/5.D2.N	2.5mm ² feed through terminal (Blue)	1SNA125490R1500	1.76
MA2,5/5.D2.V0	2.5mm ² feed through terminal (Beige) V0	1SNA195490R1400	1.72
MA2,5/5.D1.1	2.5mm ² feed through terminal with vertical interconnection and partition on lower deck (Grey)	1SNA115530R1200	1.76
MA2,5/5.D2.1	2.5mm ² feed through terminal with partition on upper and lower deck (Grey)	1SNA115491R0000	1.36

Accessories		Product Hierarchy 300008	
Type	Description	Order Code	Price
FEM6D	End section 2.5mm ² - 4.0mm ² double deck (Grey)	1SNA118499R2300	0.53
FEM6D	End section 2.5mm ² - 4.0mm ² double deck (Blue)	1SNA128499R2500	0.53
FEM6D V0	End section 2.5mm ² - 4.0mm ² double deck (Beige) V0	1SNA198499R2400	0.71
SCMA5D	Circuit separator (fits on top of terminal) (Grey)	1SNA116720R2100	0.24
BJMI5D	Jumper bar - 2 pole (IP20)	1SNA176736R2100	0.93
BJMI5D	Jumper bar - 3 pole (IP20)	1SNA176737R2200	1.30
BJMI5D	Jumper bar - 4 pole (IP20)	1SNA176738R0300	1.59
BJMI5D	Jumper bar - 5 pole (IP20)	1SNA176739R0400	1.84
BJMI5D	Jumper bar - 10 pole (IP20)	1SNA176740R1100	3.18
PC5	Comb jumper bar - 10 poles	1SNA113544R1200	1.35
EIP	Insulating tip for comb jumper bar	1SNA113550R2400	0.19
ITV5	Vertical interconnection to convert from 2 circuit to 1 circuit terminal	1SNA176259R1300	1.50

6



Full range of product and technical information place this part number in a search engine and download
1SNC160001C0207

Terminal Blocks

Double Deck Feed Through Terminals

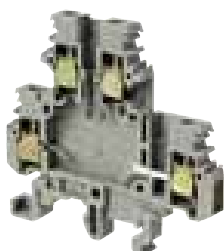

4.00mm² Double Deck Terminal Block

Product Hierarchy 300002

Type	Description	Order Code	Price
M4/6.D2	4.0mm double deck feed through terminal (Grey)	1SNA115271R2200	1.29
M4/6.D1	4.0mm double deck feed through terminal with vertical interconnection and partition on lower deck (Grey)	1SNA115166R1100	1.76
M4/6.D2.N	4.0mm double deck feed through terminal (Blue)	1SNA125271R2400	1.46
M4/6.D2.V0	4.0mm double deck feed through terminal (Beige) V0	1SNA195271R2300	1.59
M4/6.D2.1	4.0mm double deck feed through terminal with partition (Grey)	1SNA115126R0100	1.41
M4/6.D2.1.N	4.0mm double deck feed through terminal with partition (Blue)	1SNA125126R0300	1.76

Accessories

Product Hierarchy 300008

Type	Description	Order Code	Price
FEM6D	End section 2.5mm - 4.0mm double deck (Grey)	1SNA118499R2300	0.53
FEM6D	End section 2.5mm - 4.0mm double deck (Blue)	1SNA128499R2500	0.53
FEM6D V0	End section 2.5mm - 4.0mm double deck (Beige) V0	1SNA198499R2400	0.71
BJMI6D	Jumper bar - 2 pole (IP20)	1SNA179668R2000	0.96
BJMI6D	Jumper bar - 3 pole (IP20)	1SNA179669R2100	0.89
BJMI6D	Jumper bar - 4 pole (IP20)	1SNA179670R2600	1.16
BJMI6D	Jumper bar - 5 pole (IP20)	1SNA179671R1300	1.48
BJMI6D	Jumper bar - 10 pole (IP20)	1SNA179672R1400	4.33
EL6	Connector plate for linking two jumper bars together	1SNA173627R2100	0.22
PC61	Comb jumper bar - 10 pole	1SNA163311R2200	1.31
ITV6	Vertical interconnection to convert from 2 circuit to 1 circuit terminal	1SNA168962R0400	1.50



Full range of product and technical information place this part number in a search engine and download
1SNC160001C0207

Terminal Blocks

Double Deck Terminals

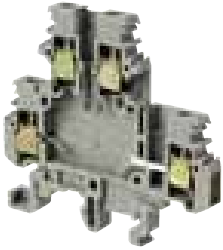

6.00mm ² Double Deck Terminal Block		Product Hierarchy 300002	
Type	Description	Order Code	Price
M4/6.D2	6.0mm double deck feed through terminal (Grey)	1SNA115501R1200	2.45
M6/8.D1	6.0mm double deck feed through terminal with vertical interconnection and partition on lower deck (Grey)	1SNA115498R1700	3.44
Accessories		Product Hierarchy 300008	
Type	Description	Order Code	Price
FEM8D1	End Section 6.0mm double deck, 1mm thick (Grey)	1SNA116656R2500	0.46
FEM8D2	End Section 6.0mm double deck, 4mm thick (Grey)	1SNA116657R2600	0.48
SCM6	Circuit separator (fits on top of terminal) (Grey)	1SNA113003R1000	0.23
SCF6D	Separator end section (grey)	1SNA118495R1700	0.46
AL2	Test socket 2mm diameter	1SNA163043R2100	0.21
AL4	Test socket 4mm diameter	1SNA163262R0100	0.20
FC2	Test plug 2mm diameter	1SNA007865R2600	1.21
BJMI8	Jumper bar - 2 pole (IP20)	1SNA176669R1600	0.82
BJMI8	Jumper bar - 3 pole (IP20)	1SNA176670R1300	1.19
BJMI8	Jumper bar - 4 pole (IP20)	1SNA176671R0000	1.53
BJMI8	Jumper bar - 5 pole (IP20)	1SNA176672R0100	1.91
BJMI8	Jumper bar - 10 pole (IP20)	1SNA176673R0200	3.47

6



Full range of product and technical information place this part number in a search engine and download
1SNC160001C0207

Terminal Blocks

Double Deck Terminals

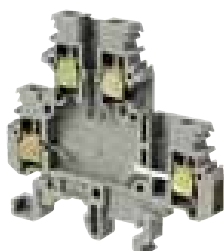

4.00mm² Double Deck Blade Disconnect Terminal Block

Product Hierarchy
300002

Type	Description	Order Code	Price
M4/6.D2.SNBT	4.0mm² double deck terminal with blade disconnect on upper deck (grey body / grey blade)	1SNA115561R1500	2.06

Accessories

Product Hierarchy
300008

Type	Description	Order Code	Price
FEMS6D	End section for M4/6.D2.SNBT	1SNA116591R0500	0.50
FC2	Test plug 2mm diameter	1SNA007865R2600	1.21
BJMI6D	Jumper bar - 2 pole (IP20)	1SNA179668R2000	0.96
BJMI6D	Jumper bar - 3 pole (IP20)	1SNA179669R2100	0.89
BJMI6D	Jumper bar - 4 pole (IP20)	1SNA179670R2600	1.16
BJMI6D	Jumper bar - 5 pole (IP20)	1SNA179671R1300	1.48
BJMI6D	Jumper bar - 10 pole (IP20)	1SNA179672R1400	4.33
EL6	Connector plate for linking two jumper bars together	1SNA173627R2100	0.22



4.00mm² Double Deck Lever Disconnect Terminal Block

Product Hierarchy
300002

Type	Description	Order Code	Price
M4/6.D2.2S2	4.0mm² double deck terminal with lever disconnect on both decks (grey body / 1 grey lever & 1 black lever)	1SNA199444R2500	4.20



Full range of product and technical information place this part number in a search engine and download
1SNC160001C0207

Terminal Blocks

Double Deck Terminals

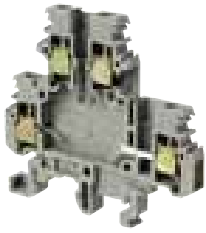

4.00mm² Double Deck Component Holder Terminal Block

Product Hierarchy 300002

Type	Description	Order Code	Price
M4/6.DE1	4.0mm² double deck component holder terminal (lower circuit only) (Grey)	1SNA115177R1400	3.53
M4/6.DE2	4.0mm² double deck component holder terminal (upper circuit only) (Grey)	1SNA115326R1100	3.48
M4/6.DE	4.0mm² double deck component holder terminal (both upper and lower circuit) (Grey)	1SNA115185R0500	4.30

Accessories

Product Hierarchy 300008

Type	Description	Order Code	Price
FEM6D	End Section 2.5mm - 4.0mm double deck (Grey)	1SNA118499R2300	0.53
BJMI6D	Jumper bar - 2 pole (IP20)	1SNA179668R2000	0.96
BJMI6D	Jumper bar - 3 pole (IP20)	1SNA179669R2100	0.89
BJMI6D	Jumper bar - 4 pole (IP20)	1SNA179670R2600	1.16
BJMI6D	Jumper bar - 5 pole (IP20)	1SNA179671R1300	1.48
BJMI6D	Jumper bar - 10 pole (IP20)	1SNA179672R1400	4.33
EL6	Connector plate for linking two jumper bars together	1SNA173627R2100	0.22



4.00mm² Double Deck Diode Terminal Block

Product Hierarchy 300002

Type	Description	Order Code	Price
M4/6.DE2.D	4.0mm² double deck diode terminal with two negative outputs (Grey)	1SNA115327R1200	5.68
M4/6.DE1.D	4.0mm² double deck diode terminal with one negative output (Grey)	1SNA115371R2600	5.49
M4/6.DD	4.0mm² double deck diode terminal with cathode connected to lower deck (Grey)	1SNA115168R2300	3.31
M4/6.DD1	4.0mm² double deck diode terminal with cathode connected to upper deck (Grey)	1SNA115184R0400	3.52

Accessories

Product Hierarchy 300008

Type	Description	Order Code	Price
FEM6D	End Section 2.5mm - 4.0mm double deck (Grey)	1SNA118499R2300	0.53
BJMI6D	Jumper bar - 2 pole (IP20)	1SNA179668R2000	0.96
BJMI6D	Jumper bar - 3 pole (IP20)	1SNA179669R2100	0.89
BJMI6D	Jumper bar - 4 pole (IP20)	1SNA179670R2600	1.16
BJMI6D	Jumper bar - 5 pole (IP20)	1SNA179671R1300	1.48
BJMI6D	Jumper bar - 10 pole (IP20)	1SNA179672R1400	4.33
EL6	Connector plate for linking two jumper bars together	1SNA173627R2100	0.22



Full range of product and technical information place this part number in a search engine and download

1SNC160001C0207

Terminal Blocks

Double Deck Terminals

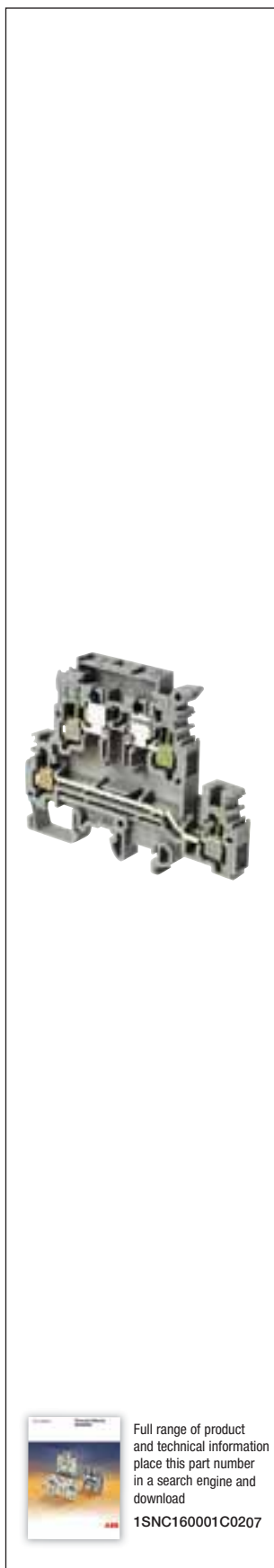

4.00mm² Double Deck Indicator Terminal Block

Product Hierarchy
300002

Type	Description	Order Code	Price
M4/6.DN	4.0mm² double deck terminal with 110VAC / 127VDC neon lamp (Grey)	1SNA115182R0200	7.78

Accessories

Product Hierarchy
300008

Type	Description	Order Code	Price
FEM6D	End Section 2.5mm - 4.0mm double deck (Grey)	1SNA118499R2300	0.53
BJMI6D	Jumper bar - 2 pole (IP20)	1SNA179668R2000	0.96
BJMI6D	Jumper bar - 3 pole (IP20)	1SNA179669R2100	0.89
BJMI6D	Jumper bar - 4 pole (IP20)	1SNA179670R2600	1.16
BJMI6D	Jumper bar - 5 pole (IP20)	1SNA179671R1300	1.48
BJMI6D	Jumper bar - 10 pole (IP20)	1SNA179672R1400	4.33
EL6	Connector plate for linking two jumper bars together	1SNA173627R2100	0.22

4.00mm² Double Deck Fuse Terminal Block

Product Hierarchy
300002

Type	Description	Order Code	Price
M4/8.D2.SFL	4.0mm² double deck terminal 5 x 20 / 5 x 25mm flip top fuse holder and 110-230V neon lamp (Grey)	1SNA115466R2200	9.61
M4/8.D2.SFD	4.0mm² double deck terminal 5 x 20 / 5 x 25mm flip top fuse holder and 24V LED (Grey)	1SNA115647R2300	9.61
M4/8.SFJ	4.0mm² double deck terminal 5 x 20 / 5 x 25mm flip top fuse holder with internal jumper option (Grey)	1SNA115692R1100	4.90

Accessories

Product Hierarchy
300008

Type	Description	Order Code	Price
FEM8D2S	End section for double deck fuse holder terminals (Grey)	1SNA116913R0700	0.66
BJMI8	Jumper bar - 2 pole (IP20)	1SNA176669R1600	0.82
BJMI8	Jumper bar - 3 pole (IP20)	1SNA176670R1300	1.19
BJMI8	Jumper bar - 4 pole (IP20)	1SNA176671R0000	1.53
BJMI8	Jumper bar - 5 pole (IP20)	1SNA176672R0100	1.91
BJMI8	Jumper bar - 10 pole (IP20)	1SNA176673R0200	3.47



Full range of product and technical information place this part number in a search engine and download
1SNC160001C0207

Terminal Blocks

Double Deck Terminals

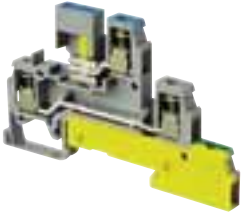

4.00mm ² Double Deck + Protection Terminal Block		Product Hierarchy 300002	
Type	Description	Order Code	Price
D4/6.NTLP	4.0mm ² neutral disconnect, live feed through and ground connection terminal block (Grey / Green / Yellow)	1SNA110439R2200	3.37
D4/6.NLP	4.0mm ² neutral feed through, live feed through and ground connection terminal block (Grey / Green / Yellow)	1SNA110440R0700	2.95

Accessories		Product Hierarchy 300008	
Type	Description	Order Code	Price
FED6	End section for D4/6.NL blocks	1SNA116964R1200	0.38

6



Full range of product and technical information place this part number in a search engine and download
1SNC160001C0207

Terminal Blocks

Triple Deck Terminals



4.00mm ² Triple Deck Fuse Terminal Block		Product Hierarchy 300002	
Type	Description	Order Code	Price
D4/6.T1	4.0mm ² triple deck feed through terminal with vertical interconnection (Black) V0 closed block	1SNA199219R0300	4.33
D4/6.T3	4.0mm ² triple deck feed through terminal (Grey) V0 closed block	1SNA299683R0100	3.44
D4/6.T3.P	4.0mm ² triple deck feed through terminal with 1 earth connection (Grey) V0 closed block	1SNA299684R0200	5.81
D4/6.PT1	4.0mm ² triple deck terminal with 7 earth connection (Green /Yellow) V0 closed block	1SNA199220R0000	6.30

Accessories		Product Hierarchy 300008	
Type	Description	Order Code	Price
BJM62	Jumper bar - 2 pole fits D4/6.T3 & D4/6.T3P	1SNA173217R2600	0.79
BJM62	Jumper bar - 4 pole fits D4/6.T3 & D4/6.T3P	1SNA173219R0000	1.42
BJM62	Jumper bar - 10 pole fits D4/6.T3 & D4/6.T3P	1SNA173226R2700	3.37
PC61	Comb jumper bar - 10 pole fits all 6mm spacing triple decks terminals	1SNA163311R2200	1.31

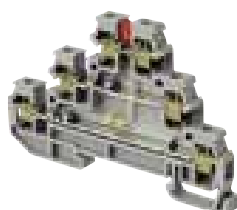

2.5mm ² Triple Deck Sensor Terminal Block		Product Hierarchy 300002	
Type	Description	Order Code	Price
D2.5/6.DA	2.5mm ² triple deck feed through terminal (Grey)	1SNA115541R1100	2.62
D2.5/6.DAL	2.5mm ² triple deck feed through terminal with 24VDC red LED between upper and middle deck (Grey)	1SNA115535R0300	4.16
D2.5/6.DAL2	2.5mm ² triple deck feed through terminal with 24VDC green LED between lower and middle deck (Grey)	1SNA115547R1700	4.16
D2.5/6.D	2.5mm ² triple deck sensor terminal (Grey)	1SNA115542R1200	1.49
D2.5/6.DL	2.5mm ² triple deck sensor terminal with 24VDC red LED between upper and middle deck (Grey)	1SNA115537R0500	3.27

Accessories		Product Hierarchy 300008	
Type	Description	Order Code	Price
FED3E	End section for triple deck sensor terminals (Grey)	1SNA116771R2000	0.41



Full range of product and technical information place this part number in a search engine and download
1SNC160001C0207

Terminal Blocks

Disconnect Terminals



2.5mm² Disconnect (Switch) Terminal Block

Product Hierarchy 300002

Type	Description	Order Code	Price
MA2.5/5.SNB	2.5mm ² disconnect terminal (Grey body, short grey blade)	1SNA115504R1500	1.38
MA2.5/5.SNBTA	2.5mm ² disconnect terminal (Grey body, short grey blade) with 2 test sockets 2.3mm diameter	1SNA115505R1600	2.30
MA2.5/5.SNB	2.5mm ² disconnect terminal (Grey body, short orange blade)	1SNA115699R2000	1.10

Accessories

Product Hierarchy 300008

Type	Description	Order Code	Price
FEM6	End Section 2.5mm ² disconnect terminal (Grey)	1SNA118368R1600	0.23
SCF6	Separator end section 2.5mm ² - 10mm ² (Grey) for CPM cover	1SNA118707R0300	0.34
SCFM6	Separator end section 2.5mm ² - 10mm ² (Grey) snaps onto dinrail, for CPM cover	1SNA114825R0500	0.48
PC5	Comb jumper bar - 10 poles	1SNA113544R1200	1.35
CBM5	Screen bar 0.5mm thickness	1SNA178745R1400	0.34
CBM8	Screen bar 0.8mm thickness	1SNA178746R1500	0.43

4.0mm² Disconnect (Switch) Terminal Block

Product Hierarchy 300002

Type	Description	Order Code	Price
M4/6.SNB	4.0mm ² disconnect terminal (Orange body, short orange blade)	1SNA105053R2200	2.15
M4/6.SNBT	4.0mm ² disconnect terminal (Orange body, short orange blade) with 2 test sockets 2.3mm diameter	1SNA105054R2300	2.52
M4/6.SNB	4.0mm ² disconnect terminal (Grey body, short orange blade)	1SNA115986R0000	1.38
M4/6.SNBT	4.0mm ² disconnect terminal (Grey body, short orange blade) with 2 test sockets 2.3mm diameter	1SNA115987R0100	1.42
M4/6.SNB	4.0mm ² disconnect terminal (Blue body, short orange blade)	1SNA125686R1500	2.12
M4/6.SNB	4.0mm ² disconnect terminal (Grey body, long grey blade)	1SNA115686R1300	2.08

Accessories

Product Hierarchy 300008

Type	Description	Order Code	Price
FEM62	End Section 4.0mm ² disconnect terminal (Grey)	1SNA114994R0700	
FEM62	End Section 4.0mm ² disconnect terminal (Orange)	1SNA103612R2500	0.27
SCFM6	Separator end section 2.5mm ² - 10mm ² (Grey) snaps onto dinrail, for CPM cover	1SNA114825R0500	0.48
CBM5	Screen bar 0.5mm thickness	1SNA178745R1400	0.34
CBM8	Screen bar 0.8mm thickness	1SNA178746R1500	0.43



Full range of product and technical information place this part number in a search engine and download
1SNC160001C0207

Terminal Blocks

Disconnect Terminals

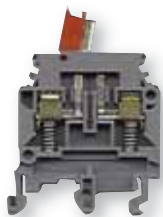

2.5mm² Disconnect (Switch) Terminal Block

Product Hierarchy
300002

Type	Description	Order Code	Price
M4/6.SNTS	4.0mm² disconnect safety terminal (Beige body, short orange blade) with 2 test sockets 2mm² dia	1SNA195229R2100	3.03

Accessories

Product Hierarchy
300008

Type	Description	Order Code	Price
FEM6	End section for M4/6.SNTS disconnect terminal (grey)	1SNA118368R1600	0.23
SCF6	Separator end section 2.5mm² - 10mm² (Grey) for CPM cover	1SNA118707R0300	0.34
SCFM6	Separator end section 2.5mm² - 10mm² (Grey) snaps onto dinrail, for CPM cover	1SNA114825R0500	0.48
CBM5	Screen bar 0.5mm thickness	1SNA178745R1400	0.34
CBM8	Screen bar 0.8mm thickness	1SNA178746R1500	0.43



4.0mm² Disconnect (Pluggable) Terminal Block

Product Hierarchy
300002

Type	Description	Order Code	Price
M4/6.SNBTA	4.0mm² disconnect terminal with plug (grey body, grey plug) with 2 test sockets 2.3mm diameter	1SNA115496R0500	2.98

Accessories

Product Hierarchy
300008

Type	Description	Order Code	Price
FEM62	End section 4.0mm² disconnect (pluggable) terminals (Grey)	1SNA114994R0700	0.27
SCFM6	Separator end section 2.5mm² - 10mm² (Grey) snaps onto dinrail, for CPM cover	1SNA114825R0500	0.48
CBM5	Screen bar 0.5mm thickness	1SNA178745R1400	0.34
CBM8	Screen bar 0.8mm thickness	1SNA178746R1500	0.43



Full range of product and technical information place this part number in a search engine and download
1SNC160001C0207

Terminal Blocks

Disconnect Terminals



6.0mm² Disconnect (Switch) Terminal Block

Product Hierarchy 300002

Type	Description	Order Code	Price
M6/8.SNB	6.0mm² disconnect terminal (grey body, long grey blade)	1SNA115688R2500	2.37
M6/8.STP	6.0mm² push turn disconnect terminal (Grey body, yellow knob)	1SNA115277R2000	2.73

Accessories

Product Hierarchy 300008

Type	Description	Order Code	Price
FEM8	End Section 6.0mm² for M6/8.SNB disconnect terminal (grey)	1SNA113373R2600	0.27
FEMT1	End Section 6.0mm² for M6/8.STP disconnect terminal (grey)	1SNA113137R0200	0.27
PC8	Comb type jumper bar 10 way	1SNA163313R2400	1.95

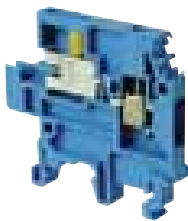

6.0mm² Interruptible Neutral Terminal Block

Product Hierarchy 300002

Type	Description	Order Code	Price
M6/8.NT	6.0mm² Neutral terminal with sliding link disconnect. Same profile as M6/8	1SNA125119R1400	2.03

Accessories

Product Hierarchy 300008

Type	Description	Order Code	Price
FEM6	End section 2.5mm² - 10mm² (Blue)	1SNA128368R1000	0.29
B03	10mm² x 3mm² copper busbar 1 metre	1SNA164406R2400	13.67
VRB3	Busbar lock	1SNA128035R1600	0.08

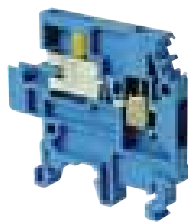

10mm² Interruptible Neutral Terminal Block

Product Hierarchy 300002

Type	Description	Order Code	Price
M10/10.NT	10mm² Neutral Block with sliding link disconnect. Same profile as M10/10	1SNA125121R0600	2.03

Accessories

Product Hierarchy 300008

Type	Description	Order Code	Price
FEM6	End Section 2.5mm² - 10mm² (Blue)	1SNA128368R1000	0.29
B03	10mm² x 3mm² copper busbar 1 metre	1SNA164406R2400	13.67
VRB3	Busbar lock	1SNA128035R1600	0.08



Full range of product and technical information place this part number in a search engine and download

1SNC160001C0207

Terminal Blocks

Disconnect Terminals

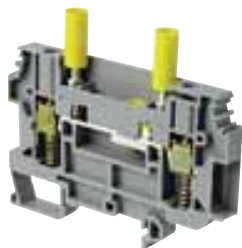

6.0mm² Sliding Link Disconnect Terminal Block

Product Hierarchy 300002

Type	Description	Order Code	Price
M6/8.ST1	6.0mm² sliding link disconnect terminal block	1SNA115236R1700	2.94
M6/8.ST4	6.0mm² sliding link disconnect terminal block for jumper bars on right side (grey)	1SNA115240R0700	2.98
M6/8.ST5	6.0mm² sliding link disconnect terminal block for jumper bars on left side (grey)	1SNA115241R2400	2.98
M6/8.ST6	6.0mm² sliding link disconnect terminal block for jumper bars left and right sides (grey)	1SNA115242R2500	2.98
M6/8.ST7	6.0mm² feed through terminal (same profile as sliding link disconnect blocks) (grey)	1SNA115243R2600	1.51
M6/8.ST7.V0	6.0mm² feed through terminal (same profile as sliding link disconnect blocks) (beige)	1SNA195243R2700	1.58
M6/8.ST1.V2.IP20	6.0mm² sliding link disconnect terminal block with 2 x 4mm IP20 test sockets (grey)	1SNA115971R1000	3.92
M6/8.ST1.V0.IP20	6.0mm² sliding link disconnect terminal block with 2 x 4mm IP20 test sockets (beige)	1SNA195639R2400	4.50
D6/8.ST1.RS	6.0mm² sliding link disconnect safety terminal block with 2 x 4mm IP20 test sockets (grey)	1SNA115831R0400	3.70

Accessories

Product Hierarchy 300008

Type	Description	Order Code	Price
FEMT2	End Section for M6/8.ST series of disconnect blocks (grey)	1SNA113629R2700	0.46
FEMT2.V0	End Section for M6/8.ST1.V2.IP20 disconnect block (beige)	1SNA193629R2000	0.47
FEM8T6	End section for D6/8.ST1.RS disconnect terminal (Grey)	1SNA215266R0100	0.65
SCFT2	Separator End Section for M6/8.ST series of disconnect blocks (grey)	1SNA114522R0500	0.65
SCFT2.V0	Separator End Section for M6/8.ST series of disconnect blocks (beige)	1SNA194522R0600	0.76
AL4	4mm test socket	1SNA163313R2400	0.23
PC8	Comb jumper bar - 10 pole	1SNA163313R2400	1.95
PCS4	Sliding switch bridge - 4 pole	1SNA199870R0400	1.87
PCS2	Sliding switch bridge - 2 pole	1SNA199871R2100	1.25



Full range of product and technical information place this part number in a search engine and download
1SNC160001C0207

Terminal Blocks

Power Terminals



Single Stud Terminals

Type	Description	Order Code	Price
M35/26.F	1 x M6 studs (Grey)	1SNA115141R1000	2.30
M70/31.F	1 x M8 studs (Grey)	1SNA115144R1300	2.89
M120/35.F	1 x M8 studs (Grey)	1SNA115147R1600	3.46

Product Hierarchy 300007

Double Stud Terminals

D35/27.FF	2xM6 studs (Grey) V0	1SNA190001R2000	5.72
D70/32.FF	2xM8 studs (Grey) V0	1SNA190002R2100	6.94
D120/42.FF	2xM10 studs (Grey) V0	1SNA190003R2200	10.71
D185/55.FF	2xM12 studs (Grey) V0	1SNA190004R2300	12.75
D300/55.FF	2xM16 studs (Grey) V0	1SNA190005R2400	16.53

M35/26.FF	2 x M6 studs (Grey)	1SNA115140R2300	3.39
M70/31.FF	2 x M8 studs (Grey)	1SNA115143R1200	5.40
M120/35.FF	2 x M8 studs (Grey)	1SNA115146R1500	6.89
M300/42.FF	2 x M10 studs (Grey)	1SNA115149R2000	8.61

Accessories

Product Hierarchy 300008

Type	Description	Order Code	Price
CPUF35	Covers for D35/27.FF (2 required per terminal)	1SNA190016R1600	1.05
CPUF70	Covers for D70/32.FF (2 required per terminal)	1SNA190017R1700	1.19
CPUF120	Covers for D120/42.FF (2 required per terminal)	1SNA190018R2000	1.51
CPUF185	Covers for D185/55.FF & D300/55.FF (2 required per terminal)	1SNA190019R2100	2.16

BJS27	Jumper bar 2 way for D35/27.FF	1SNA205772R1300	4.73
BJS27	Jumper bar 3 way for D35/27.FF	1SNA205773R1400	4.73
BJS32	Jumper bar 2 way for D70/32.FF	1SNA205774R1500	11.37
BJS32	Jumper bar 3 way for D70/32.FF	1SNA205775R1600	13.75
BJS42	Jumper bar 2 way for D120/42.FF	1SNA205776R1700	11.77
BJS42	Jumper bar 3 way for D120/42.FF	1SNA205777R1000	4.46
BJS551	Jumper bar 2 way for D185/55.FF & D300/55.FF	1SNA205778R2100	12.94
BJS551	Jumper bar 3 way for D185/55.FF & D300/55.FF	1SNA205779R2200	12.37

ECP26	Partition for M35/26.F & .FF terminals (Grey)	1SNA113689R2400	0.40
ECP31	Partition for M70/31.F & .FF terminals (Grey)	1SNA113690R2100	0.46
ECP35	Partition for M120/35.F & .FF terminals (Grey)	1SNA113691R1600	0.67
ECP42	Partition for M300/42.FF terminals (Grey)	1SNA113692R1700	0.80

CPP261	Cover for 1 x M35/36.F or .FF terminal (2 ECP26 partitions required) (Clear)	1SNA168202R1300	0.85
CPP262	Cover for 2 x M35/36.F or .FF terminals (2 ECP26 partitions required) (Clear)	1SNA168201R1200	1.40
CPP263	Cover for 3 x M35/36.F or .FF terminals (2 ECP26 partitions required) (Clear)	1SNA163403R2000	1.65
CPP311	Cover for 1 x M70/32.F or .FF terminal (2 ECP31 partitions required) (Clear)	1SNA168204R1500	0.92
CPP312	Cover for 2 x M70/32.F or .FF terminals (2 ECP31 partitions required) (Clear)	1SNA168203R1400	1.54



Full range of product and technical information place this part number in a search engine and download

1SNK161001C0201

Terminal Blocks

Power Terminals

Accessories		Product Hierarchy 300008	
Type	Description	Order Code	Price
CPP313	Cover for 3 x M70/32.F or .FF terminals (2 ECP31 partitions required) (Clear)	1SNA163409R0600	1.86
CPP351	Cover for 1 x M120/32.F or .FF terminal (2 ECP35 partitions required) (Clear)	1SNA168206R1700	0.99
CPP352	Cover for 2 x M120/32.F or .FF terminals (2 ECP35 partitions required) (Clear)	1SNA168205R1600	1.69
CPP353	Cover for 3 x M120/32.F or .FF terminals (2 ECP35 partitions required) (Clear)	1SNA163418R2600	2.07
CPP422	Cover for 2 x M300/42.FF terminals (2 ECP42 partitions required) (Clear)	1SNA168207R1000	1.95
CPP423	Cover for 3 x M300/42.FF terminals (2 ECP42 partitions required) (Clear)	1SNA163424R1400	2.47



Full range of product and technical information place this part number in a search engine and download
1SNK161001C0201

Terminal Blocks

Security Terminals

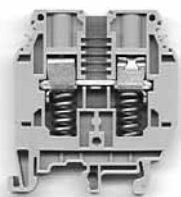

Safety Connection Terminal Blocks

Product Hierarchy 300002

Type	Description	Order Code	Price
M4/6.RS	4.0mm feed through terminal with safety connection (Grey)	1SNA115930R1300	1.17
M6/8.RS	6.0mm feed through terminal with safety connection (Grey)	1SNA115685R1200	0.95
M10/10.RS	10.0mm feed through terminal with safety connection (Grey)	1SNA115320R2700	1.28
M4/6.SNTS	4.0mm disconnect terminal (Grey body, short orange blade) with safety connection	1SNA115229R2000	2.53
M6/8.STPRS	6.0mm feed through terminal with safety connection (Grey) with 1/4 turn disconnect	1SNA115678R0200	3.87

Accessories

Product Hierarchy 300008

Type	Description	Order Code	Price
FEMR8	End section for M4/6.RS & M6/8.RS	1SNA116987R0200	0.34
FEMR10	End section for M10/10.RS	1SNA114434R0500	0.38
FEM6	End section for M4/6.SNTS	1SNA118368R1600	0.23
FEMR8T	End section for M6/8.STPRS	1SNA116991R0600	0.39
AL4	4.0mm Test socket for M6/8.RS	1SNA179762R1600	0.28
BP8.A4	Bridging plug, 2 pole for M6/8.RS	1SNA173888R2000	4.93
BJS10	Unassembled jumper bar, 2 pole for M10/10.RS	1SNA164585R1700	0.25
BJS10	Unassembled jumper bar, 10 pole for M10/10.RS	1SNA164588R2200	1.29
BJS10	Unassembled jumper bar, 20 pole for M10/10.RS	1SNA177654R0000	2.74
PL101	Central socket and screw for unassembled jumper bar for M10/10.RS	1SNA163181R1100	0.47
BJS8	Unassembled jumper bar, 2 pole for M6/8.RS	1SNA164581R1300	0.25
BJS8	Unassembled jumper bar, 3 pole for M6/8.RS	1SNA164582R1400	0.28
BJS8	Unassembled jumper bar, 5 pole for M6/8.RS	1SNA164737R2600	0.38
EV6I	Screw, post and washer for jumper bar for M4/6.RS and M6/8.RS	1SNA206394R0200	0.22
EP6	Protection label for 4 x 6mm pitch blocks	1SNA163427R1700	0.91
VSP6	Nylon screw for EP6 label	1SNA163433R1500	0.11

6



Full range of product and technical information place this part number in a search engine and download
1SNK161001C0201

Terminal Blocks

Fuse Terminals

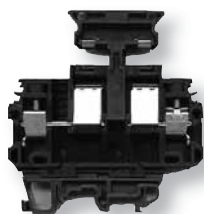
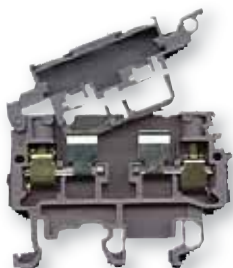

Full range of product and technical information place this part number in a search engine and download
1SNK161001C0201

4.0mm² Fuse Terminal Blocks

Product Hierarchy 300002

Type	Description	Order Code	Price
M4/8.SF	Fuse terminal (flip top) for 5x20, 5x25mm fuse (Grey)	1SNA115657R2500	2.12
M4/8.SF2	Fuse terminal (flip top) for 5x20, 5x25mm fuse (Orange)	1SNA105135R1100	2.73
M4/8.SF.V0	Fuse terminal (flip top) for 5x20, 5x25mm fuse (Beige) V0	1SNA195657R2600	2.97
M4/8.SFL	Fuse terminal (flip top) for 5x20, 5x25mm fuse (Grey) with green neon lamp 110-230V	1SNA115661R2100	5.30
M4/8.SFD	Fuse terminal (flip top) for 5x20, 5x25mm fuse (Grey) with 24V LED	1SNA115663R2300	5.22
M4/8.SFDT	Fuse terminal (flip top) for 5x20, 5x25mm fuse (Grey) with 24V LED and 2 test sockets 2mm	1SNA115665R2500	5.79
M4/8.SN2	Fuse terminal (flip top) complete with CN5 neutral bar (Grey blue, Blue lever)	1SNA115659R0700	3.81
M4/8.SN2	Fuse terminal (flip top) complete with CN5 neutral bar (Orange)	1SNA105136R1200	3.81
M4/6.SB	Disconnect terminal for BFAUTO mini automotive fuse holder (Grey)	1SNA115435R0700	1.90

Accessories

Product Hierarchy 300008

Type	Description	Order Code	Price
FEM8S	End section for M4/8.SF fuse terminal (Grey)	1SNA116951R1500	0.36
FEM8S	End section for M4/8.SF fuse terminal (Orange)	1SNA103923R1500	0.62
FEM8S	End section for M4/8.SF fuse terminal (Beige) V0	1SNA196951R1600	0.36
PC81	Jumper bar (comb style) 10 way	1SNA173523R1100	2.42
TGA8	Assembly rod, 2 pole, to link flip top fuse carriers M4/8.SF M4/8.SN series.	1SNA168672R1100	0.56
ANT	Assembly ring locks TGA8 in place on flip top fuse carriers M4/8.SF M4/8.SN series.	1SNA168675R1400	0.06

4.0mm² Double Deck Fuse Terminal Blocks

Product Hierarchy 300002

Type	Description	Order Code	Price
M4/8.D2.SF	Fuse terminal (flip top) for 5x20, 5x25mm fuse (Grey)	1SNA115604R2100	2.44

6.0mm² Fuse Terminal Blocks

M10/16.SF1	6mm Fuse terminal (pull top) for 11/32" x 1'1/4" fuse (Grey body & holder) closed block	1SNA115375R2200	3.44
M10/16.SN1	6mm Fuse terminal (pull top) for 11/32" x 1'1/4" fuse (Grey body blue holder) closed block	1SNA115376R2300	4.89
M10/16.SF	6mm Fuse terminal (pull top) for 1/4" x 1'1/4" fuse (Grey body & holder) closed block	1SNA115377R2400	2.72
M10/16.SN	6mm Fuse terminal (pull top) for 1/4" x 1'1/4" fuse (Grey body blue holder) closed block	1SNA115379R0600	6.17

Accessories

Product Hierarchy 300008

Type	Description	Order Code	Price
PC16	Comb jumper bar, 4 pole for M10/16.SF terminals	1SNA116734R1300	3.38
PC16	Comb jumper bar, 10 poles for M10/16.SF terminals	1SNA116735R1400	4.56

Terminal Blocks

Fuse Terminals

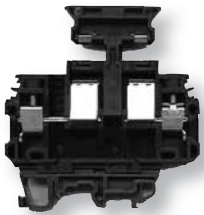

10mm ² Fuse Terminal Blocks		Product Hierarchy 300002	
Type	Description	Order Code	Price
MB10/12.SF	10mm Fuse terminal (screw top) for 5x20, 5x25mm fuse (Grey)	1SNA111033R0300	3.58
MB10/12.SFL	10mm Fuse terminal (screw top) for 5x20, 5x25mm fuse (Grey) with neon fuse blown indication (110/220v)	1SNA111034R0400	7.36
MB10/22.SF	10mm Fuse terminal (pull top) for 11/32" x 1 1/2" fuse (Grey body & holder) closed block	1SNA116302R2300	5.15
MB10/22.SN	10mm Fuse terminal (pull top) for 11/32" x 1 1/2" fuse (Grey body blue holder) closed block	1SNA116304R2500	6.20
MU10/14.5.SF1	10mm Fuse terminal (pull top) for 5x20 & 5x25mm fuse (Black body & holder) closed block	1SNA199011R1600	5.59
MU10/14.5.SF2	10mm Fuse terminal (pull top) for 1/4" x 1 1/4" fuse (Black body & holder) closed block	1SNA199013R1000	3.57
MU10/13.SF2	10mm Fuse terminal (pull top) for 1/4" x 1 1/4" fuse (Black body & holder) open block	1SNA199014R1100	3.57
MU10/13.SN3	10mm Fuse terminal (pull top) for 1/4" x 1 1/4" fuse (Black body & blue holder) open block	1SNA199021R1000	7.83
ML10/13.SF	10mm Fuse terminal (flip top) for 1/4" x 1 1/4" fuse (Black body & holder) open block	1SNA199095R1300	3.54
ML10/13.SN	10mm Fuse terminal (flip top) for 1/4" x 1 1/4" fuse (Black body & blue holder) open block	1SNA199105R2200	8.56
Accessories		Product Hierarchy 300008	
Type	Description	Order Code	Price
FEM12S	End section for MB10/12 fuse blocks	1SNA117628R2200	0.43
FEM13U	End section for MU10/13 & ML10/13 fuse blocks	1SNA199635R2400	0.39
BJS131	Unassembled jumper bar, 10 pole for MU10/13 series fuse terminals	1SNA175991R1100	2.29
VJS11	Screw for BJS131 jumper bar	1SNA163394R2600	0.03
RJD11	Washer for BJS131 jumper bar	1SNA168783R0100	0.02
PC13	Comb jumper bar 10 pole for MU10/13 series fuse terminals	1SNA173510R2000	5.23
BJS12	Unassembled jumper bar, 20 pole for MB10/12 series fuse terminals	1SNA177653R0700	2.43
	Screw for BJS12 jumper bar	1SNA163574R2200	0.07
	Washer for BJS12 jumper bar	1SNA163633R2500	0.02
PC22	Comb jumper bar 3 pole for MB10/22 series fuse terminals	1SNA205295R0600	2.94
PC22	Comb jumper bar 10 pole for MB10/22 series fuse terminals	1SNA174151R2500	7.39



Full range of product and technical information place this part number in a search engine and download

1SNK161001C0201

Terminal Blocks

Fuse Terminals

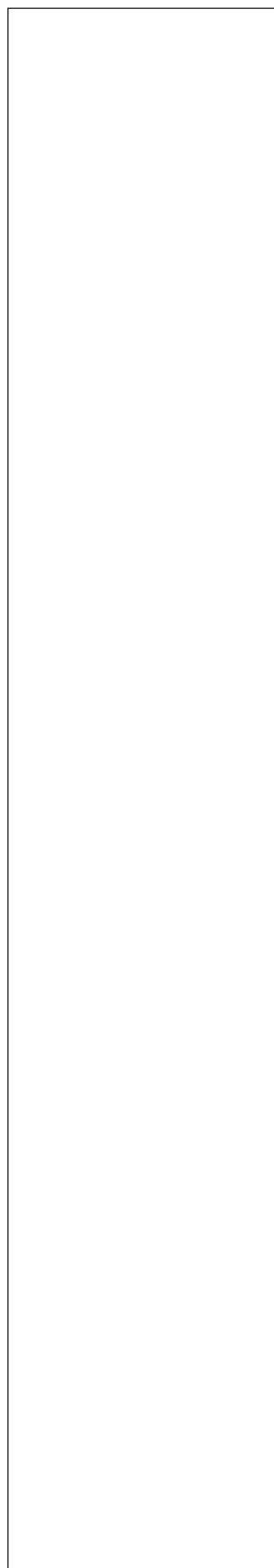

Accessories		Product Hierarchy 300008	
Type	Description	Order Code	Price
FU520	5 x 20mm 250V 0.5A fuse	1SNA008288R1500	0.41
FU520	5 x 20mm 250V 1A fuse	1SNA008290R1300	0.41
FU520	5 x 20mm 250V 2A fuse	1SNA008291R0000	0.41
FU520	5 x 20mm 250V 3.15A fuse	1SNA008289R1600	0.41
FU520	5 x 20mm 250V 5A fuse	1SNA008292R0100	0.41
FU525	5 x 25mm 250V 2.5A fuse	1SNA167548R0400	3.57
FU525	5 x 25mm 250V 4A fuse	1SNA167549R0500	0.36
CN5	5 x 25mm neutral bar	1SNA179371R1600	0.30
FU103	10.3 x 38mm 500V 8A fuse	1SNA167079R0100	1.86
FU103	10.3 x 38mm 500V 10A fuse	1SNA167080R2700	1.73
FU103	10.3 x 38mm 500V 25A fuse	1SNA167084R1700	1.73
FU853	8.5 x 31.5mm 6A fuse	1SNA163849R0600	1.32
FU633	6.35 x 32mm 4A quick blow fuse	1SNA168559R1000	0.39
FU633	6.35 x 32mm 6.3A quick blow fuse	1SNA168560R1500	0.39
CN	6.35 x 32mm neutral bar	1SNA173582R1500	2.21
BFAUTO	Automotive style fuse holder (black) for use with M4/6.SB terminals	1SNA299486R2400	0.63

Terminal Blocks

Distribution Blocks



Distribution Bars		Product Hierarchy 300002	
Type	Description	Order Code	Price
DBTI	7 way neutral bar DIN 3 mounting (Blue)	1SNA356100R1500	2.94
DBTI	7 way neutral bar DIN 3 mounting (Green)	1SNA356101R0200	3.08
DBTI	12 way neutral bar DIN 3 mounting (Blue)	1SNA356102R0300	
DBTI	12 way neutral bar DIN 3 mounting (Green)	1SNA356103R0400	4.14

Distribution Terminals			
Type	Description	Order Code	Price
MB4/6.L2	2 x 4mm² terminals commoned internally (Grey)	1SNA115406R1300	1.70
MB4/6.L3	3 x 4mm² terminals commoned internally (Grey)	1SNA115407R1400	2.43
MB4/6.L4	4 x 4mm² terminals commoned internally (Grey)	1SNA115408R2500	3.11
MB4/6.L5	5 x 4mm² terminals commoned internally (Grey)	1SNA115409R2600	3.90
MB4/6.L10	10 x 4mm² terminals commoned internally (Grey)	1SNA115412R0000	7.55

MB6/8.L5	5 x 6mm² terminals commoned internally (Grey)	1SNA115416R0400	5.56
----------	---	-----------------	------

MB10/10.L2	2 x 10mm² terminals commoned internally (Grey)	1SNA115328R2300	2.71
------------	--	-----------------	------

MB70/10.L4	1 x 70mm² stud + 4 x 10mm² terminals commoned internally (grey)	1SNA115336R1300	19.53
MB70/10.L6	1 x 70mm² stud + 6 x 10mm² terminals commoned internally (grey)	1SNA115337R1400	22.77
MB70/10.L8	1 x 70mm² stud + 8 x 10mm² terminals commoned internally (grey)	1SNA115338R2500	26.03

BRU80A	80A distribution block (light grey)	1SNA356208R2500	8.62
BRU125A	125A distribution block (light grey)	1SNA356204R1100	10.73
BRU160A	160A distribution block (light grey)	1SNA356200R2100	21.28
BRU175A	175A distribution block (light grey)	1SNA356212R0000	21.54
BRU250A	250A distribution block (light grey)	1SNA179657R1500	39.96
BRU400A	400A distribution block (light grey)	1SNA179650R2200	42.17

BRTC125A	125A four pole distribution block (light grey)	1SNA356211R0700	25.74
BRT80A	80A four pole distribution block (black)	1SNA179534R2200	21.84
BRT125A	125A four pole distribution block (black)	1SNA179535R2300	28.47
BRT160A	160A four pole distribution block (black)	1SNA179892R2200	56.21

Accessories		Product Hierarchy 300008	
Type	Description	Order Code	Price
BO16/5	16 x 5mm busbar to electrically connect two BRU160A together	1SNA356201R1600	4.40

Terminal Blocks

General Accessories



Din Rails		Product Hierarchy 300008	
Type	Description	Order Code	Price
PR30	DIN 3 (TS35) zinc plated, top hat shallow slotted din rail - 2 metres	1SNA173220R0500	3.41
PR3	DIN 3 (TS35) zinc plated, top hat shallow solid din rail - 2 metres	1SNA174300R1700	3.21
PR3.G2	DIN 3 (TS35) galvanised steel, top hat shallow solid din rail - 2 metres	1SNA164800R0300	2.28
PR50	DIN 3 (TS35) zinc plated, top hat deep slotted din rail - 2 metres	1SNA178529R0400	5.01
PR5	DIN 3 (TS35) zinc plated, top hat deep solid din rail - 2 metres	1SNA168700R2200	7.75
PR4	DIN 3 (EN50022) zinc plated, top hat deep solid din rail - 2 metres	1SNA168500R1200	11.19
PR1.Z2	DIN 1 (TS32) zinc plated, "G" rail shallow solid din rail - 2 metres	1SNA163050R0400	4.06
PR1.A2	DIN 1 (TS32) aluminium, "G" rail shallow solid din rail - 3 metres	1SNA167120R2300	17.71
PR2	EN50045 zinc plated, 15mm symmetrical slotted rail - 2 metres	1SNA164600R1200	3.45
PRH2R	NFC93461 solid reinforced rail - 2 metres	1SNA163350R1500	18.12
EM45	45° rail offset bracket	1SNA008521R2600	0.83
End Stops			
BADL	Screwless end stop for DIN 3 rail (light grey)	1SNA399903R0200	0.41
BAM2	Screwed end stop for DIN 3 rail (grey)	1SNA206351R1600	0.41
BAMH	Tall Screwed end stop for DIN 1 & 3 rail (grey)	1SNA114836R0000	0.94
BADH	Tall Screwed end stop for DIN 3 rail (grey)	1SNA116900R2700	1.63
BADRL	Screwless end stop for DIN 2 rail (light grey)	1SNA199420R2100	0.44
BAR	Screwless end stop for DIN 1 rail (beige)	1SNA164519R2400	0.58

Terminal Blocks

Spring Clamp Terminal Blocks



1.5mm² Terminal Blocks 1in 1out

		Product Hierarchy 300005	
Type	Description	Order Code	Price
D1.5/4.2L	1.5mm feed through spring clamp terminal (Grey)	029037112	0.44
D1.5/4.P2L	1.5mm feed through spring clamp terminal (Earth) Green / Yellow	029037922	1.70

Accessories

		Product Hierarchy 300008 - 300002	
Type	Description	Order Code	Price
FED5.2L	End section for 1.5-4.0mm spring clamp terminals (Grey)	029106124	0.24
FED5.2L	End section for 1.5-4.0mm spring clamp terminals (Orange)	029106225	0.24
SCD5.2L	Seperator for 1.5-4.0mm spring clamp terminals (Orange)	029135204	0.18
SCD5.2L	Seperator for 1.5-4.0mm spring clamp terminals (Grey)	029135103	0.27



1.5mm² Terminal Blocks 2in 2out

		Product Hierarchy 300005 - 300002	
Type	Description	Order Code	Price
D1.5/4.4L	1.5mm feed through spring clamp terminal (Grey)	029038105	0.79
D1.5/4.4L	1.5mm feed through spring clamp terminal, (Blue)	029038307	0.82
D1.5/4.P4L	1.5mm feed through spring clamp terminal (Earth) Green / Yellow	029038915	3.02

Accessories

		Product Hierarchy 300008	
Type	Description	Order Code	Price
FED5.4L	End section for 1.5mm spring clamp terminals (Grey)	029104120	0.25

Terminal Blocks

Spring Clamp Terminal Blocks

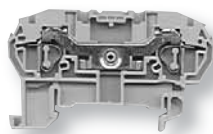

2.5mm² Terminal Blocks 1in 1out

Product Hierarchy 300005

Type	Description	Order Code	Price
D2.5/5.2L	2.5mm feed through spring terminal (Grey)	029002127	0.49
D2.5/5.N.2L	2.5mm feed through spring terminal, (Blue)	029002321	0.52
D2.5/5.P2L	2.5mm feed through spring terminal, Earth (Green/Yellow)	029002907	1.70

Accessories

Product Hierarchy 300008 - 300002

Type	Description	Order Code	Price
FED5.2L	End section for 1.5-4.0mm spring clamp terminals (Grey)	029106124	0.24
FED5.2L	End section for 1.5-4.0mm spring clamp terminals (Orange)	029106225	0.24
SCD5.2L	Seperator for 1.5-4.0mm spring clamp terminals (Orange)	029135204	0.18
SCD5.2L	Seperator for 1.5-4.0mm spring clamp terminals (Grey)	029135103	0.27
BJDL5.2	Jumper bar 2 Way (IP20)	029110223	0.29
BJDL5.3	Jumper bar 3 Way (IP20)	029110324	0.49
BJDL5.4	Jumper bar 4 Way (IP20)	029110425	0.87
BJDL5.5	Jumper bar 5 Way (IP20)	029110526	1.03
BJDL5.10	Jumper bar 10 Way (IP20)	029111026	1.77

2.5mm² Terminal Blocks 1in 2out

Product Hierarchy 300005

Type	Description	Order Code	Price
D2.5/5.3L	2.5mm feed through spring terminal (Grey)	029003121	0.60

Accessories

Product Hierarchy 300008

Type	Description	Order Code	Price
FED5.3L	End section for 2.5mm spring clamp terminals (Grey)	029106124	0.24
BJDL5.2	Jumper bar 2 Way (IP20)	029110223	0.29
BJDL5.3	Jumper bar 3 Way (IP20)	029110324	0.49
BJDL5.4	Jumper bar 4 Way (IP20)	029110425	0.87
BJDL5.5	Jumper bar 5 Way (IP20)	029110526	1.03
BJDL5.10	Jumper bar 10 Way (IP20)	029111026	1.77

Terminal Blocks

Spring Clamp Terminal Blocks



2.5mm² Terminal Blocks 2in 2out

Product Hierarchy 300005

Type	Description	Order Code	Price
D2.5/5.4L	2.5mm feed through spring terminal (Grey)	029001125	0.72
D2.5/5.N.4L	2.5mm feed through spring terminal (Blue)	029001327	0.76
D2.5/5.P4L	2.5mm feed through spring terminal Earth (Green / Yellow + C30)	029001905	2.37
D2.5/5.2L.2L	2.5mm feed through spring terminal (Grey) (2 Independent circuits)	029000104	0.81

Accessories

Product Hierarchy 300008

Type	Description	Order Code	Price
FED5.4L	End section for 2.5mm spring clamp terminals (Grey)	029104120	0.25
BJDL5.2	Jumper bar 2 Way (IP20)	029110223	0.29
BJDL5.3	Jumper bar 3 Way (IP20)	029110324	0.49
BJDL5.4	Jumper bar 4 Way (IP20)	029110425	0.87
BJDL5.5	Jumper bar 5 Way (IP20)	029110526	1.03
BJDL5.10	Jumper bar 10 Way (IP20)	029111026	1.77



2.5mm² Terminal Blocks Double Deck

Product Hierarchy 300005

Type	Description	Order Code	Price
D2.5/5.D2.L	2.5mm feed through double deck spring terminal (Grey)	029016100	1.49

Accessories

Product Hierarchy 300008

Type	Description	Order Code	Price
FEDL5.D.L	End section for 2.5mm double deck spring clamp terminals (Grey)	029144126	0.38
BJDL5.2	Jumper bar 2 Way (IP20)	029110223	0.29
BJDL5.3	Jumper bar 3 Way (IP20)	029110324	0.49
BJDL5.4	Jumper bar 4 Way (IP20)	029110425	0.87
BJDL5.5	Jumper bar 5 Way (IP20)	029110526	1.03
BJDL5.10	Jumper bar 10 Way (IP20)	029111026	1.77

Terminal Blocks

Spring Clamp Terminal Blocks



2.5mm² Miniblock Terminals		Product Hierarchy 300005	
Type	Description	Order Code	Price
DR2.5/5.2L	2.5mm feed through miniblock spring terminal (Grey)	029020111	0.48
DR2.5/5.2L	2.5mm feed through miniblock spring terminal (Orange)	029020212	0.48
DR2.5/10.P4L	2.5mm (4 spring) feed through miniblock terminal (Earth) Green / Yellow	029021912	1.39

Accessories		Product Hierarchy 300008	
Type	Description	Order Code	Price
FED1.L	End section for 2.5mm miniblock terminal (Grey)	029130102	0.13
BJDL5.2	Jumper bar 2 Way (IP20)	029110223	0.29
BJDL5.3	Jumper bar 3 Way (IP20)	029110324	0.49
BJDL5.4	Jumper bar 4 Way (IP20)	029110425	0.87
BJDL5.5	Jumper bar 5 Way (IP20)	029110526	1.03
BJDL5.10	Jumper bar 10 Way (IP20)	029111026	1.77



2.5mm² Terminal Block for Sensor & Actuators		Product Hierarchy 300005	
Type	Description	Order Code	Price
D2.5/5 C3.L	2.5mm² Terminal block for sensors / actuators	029035021	1.95

Accessories		Product Hierarchy 300008	
Type	Description	Order Code	Price
FED5.C3.L	End section for D2.5/5 C3.L	029035825	0.35
BJDL5.2	Jumper bar 2 Way (IP20)	029110223	0.29
BJDL5.3	Jumper bar 3 Way (IP20)	029110324	0.49
BJDL5.4	Jumper bar 4 Way (IP20)	029110425	0.87
BJDL5.5	Jumper bar 5 Way (IP20)	029110526	1.03
BJDL5.10	Jumper bar 10 Way (IP20)	029111026	1.77

Terminal Blocks

Spring Clamp Terminal Blocks



4.0mm ² Terminal Blocks 1in 1out		Product Hierarchy 300005	
Type	Description	Order Code	Price
D4/6.2L	4.0mm feed through spring clamp terminal (Grey)	029006107	0.50
D4/6.2L	4.0mm feed through spring clamp terminal, (Blue)	029006301	0.53
D4/6.P2L	4.0mm feed through spring clamp terminal (Earth) Green / Yellow	029006917	1.73

Accessories		Product Hierarchy 300008	
Type	Description	Order Code	Price
FED5.2L	End section for 1.5-4.0mm spring clamp terminals (Grey)	029106124	0.24
FED5.2L	End section for 1.5-4.0mm spring clamp terminals (Orange)	029106225	0.24
SCD5.2L	Seperator for 1.5-4.0mm spring clamp terminals (Orange)	029135204	0.18
SCD5.2L	Seperator for 1.5-4.0mm spring clamp terminals (Grey)	029135103	0.27
BJDL6.2	Jumper bar 2 Way (IP20)	029112824	0.53
BJDL6.3	Jumper bar 3 Way (IP20)	029112925	0.76

4.0mm ² Terminal Blocks 1in 2out		Product Hierarchy 300005	
Type	Description	Order Code	Price
D4/6.3L	4.0mm feed through spring clamp terminal (Grey)	029040506	0.61
D4/6.3L	4.0mm feed through spring clamp terminal, (Blue)	029040700	0.64
D4/6.P3L	4.0mm feed through spring clamp terminal (Earth) Green / Yellow	029040912	2.33

Accessories		Product Hierarchy 300008	
Type	Description	Order Code	Price
FED6.3L	End section for 1.5-4.0mm spring clamp terminals (Grey)	029169424	0.30
BJDL6.2	Jumper bar 2 Way (IP20)	029112824	0.53
BJDL6.3	Jumper bar 3 Way (IP20)	029112925	0.76

Terminal Blocks

Spring Clamp Terminal Blocks



4.0mm² Terminal Blocks 2in 2out

Product Hierarchy 300005

Type	Description	Order Code	Price
D4/6.4L	4.0mm feed through spring clamp terminal (Grey)	029041006	0.73
D4/6.4L	4.0mm feed through spring clamp terminal, (Blue)	029041224	0.77

Accessories

Product Hierarchy 300008

Type	Description	Order Code	Price
FED6.4L	End section for 1.5-4.0mm spring clamp terminals (Grey)	029169626	0.29
BJDL6.2	Jumper bar 2 Way (IP20)	029112824	0.53
BJDL6.3	Jumper bar 3 Way (IP20)	029112925	0.76

6.0mm² Terminal Blocks 1in 1out

Product Hierarchy 300005

Type	Description	Order Code	Price
D6/8.2L	6.0mm feed through spring clamp terminal (Grey)	029008124	0.68
D6/8.N.2L	6.0mm feed through spring clamp terminal, (Blue)	029008326	0.72
D6/8.P.2L	6.0mm feed through spring clamp terminal (Earth) Green / Yellow	029008904	2.09

Accessories

Product Hierarchy 300008

Type	Description	Order Code	Price
FED8.2L	End section for 6.0mm spring clamp terminals (Grey)	029116125	0.25
BJDL8.2	Jumper bar 2 Way (IP20)	029112216	0.66

10mm² Terminal Blocks 1in 1out

Product Hierarchy 300005

Type	Description	Order Code	Price
D10/10.2L	10.0mm feed through spring clamp terminal (Grey)	029029103	0.87
D10/10.N.2L	10.0mm feed through spring clamp terminal, (Blue)	029029305	0.90
D10/10.P.2L	10.0mm feed through spring clamp terminal (Earth) Green / Yellow	029029913	2.43

Accessories

Product Hierarchy 300008

Type	Description	Order Code	Price
FED10.2L	End section for 10.0mm spring clamp terminals (Grey)	029146122	0.41
BJDL10.2	Jumper bar 2 Way (IP20)	029147225	1.08



Terminal Blocks

Spring Clamp Terminal Blocks



16mm ² Terminal Blocks 1in 1out		Product Hierarchy 300005	
Type	Description	Order Code	Price
D16/12.2L	16.0mm feed through spring clamp terminal (Grey)	039958127	1.34
D16/12.N.2L	16.0mm feed through spring clamp terminal, (Blue)	039958220	1.39
D16/12.P.2L	16.0mm feed through spring clamp terminal (Earth) Green / Yellow	039958422	3.55

Accessories		Product Hierarchy 300008	
Type	Description	Order Code	Price
FED12.2L	End section for 16.0mm spring clamp terminals (Grey)	039957104	0.43

35mm ² Terminal Blocks 1in 1out		Product Hierarchy 300005	
Type	Description	Order Code	Price
D35/16.2L	35.0mm feed through spring clamp terminal (Grey)	039961702	2.64
D35/16.N.2L	35.0mm feed through spring clamp terminal, (Blue)	039961813	2.75
D35/16.P.2L	35.0mm feed through spring clamp terminal (Earth) Green / Yellow	039962011	5.41

2.5mm ² Disconnect (switch) Terminal Blocks 1in 1out		Product Hierarchy 300005	
Type	Description	Order Code	Price
D2.5/5.SNBT.2L	2.5mm ² disconnect terminal (Grey body, short orange blade)	029004103	1.49

Accessories		Product Hierarchy 300008	
Type	Description	Order Code	Price
FED5.2L	End section for 1.5-4.0mm spring clamp terminals (Grey)	029106124	0.24
FED5.2L	End section for 1.5-4.0mm spring clamp terminals (Orange)	029106225	0.24
SCD5.2L	Separator for 1.5-4.0mm spring clamp terminals (Orange)	029135204	0.18
BJDL5.2	Jumper bar 2 Way (IP20)	029110223	0.29
BJDL5.3	Jumper bar 3 Way (IP20)	029110324	0.49
BJDL5.4	Jumper bar 4 Way (IP20)	029110425	0.87
BJDL5.5	Jumper bar 5 Way (IP20)	029110526	1.03
BJDL5.10	Jumper bar 10 Way (IP20)	029111026	1.77

Terminal Blocks

Spring Clamp Terminal Blocks

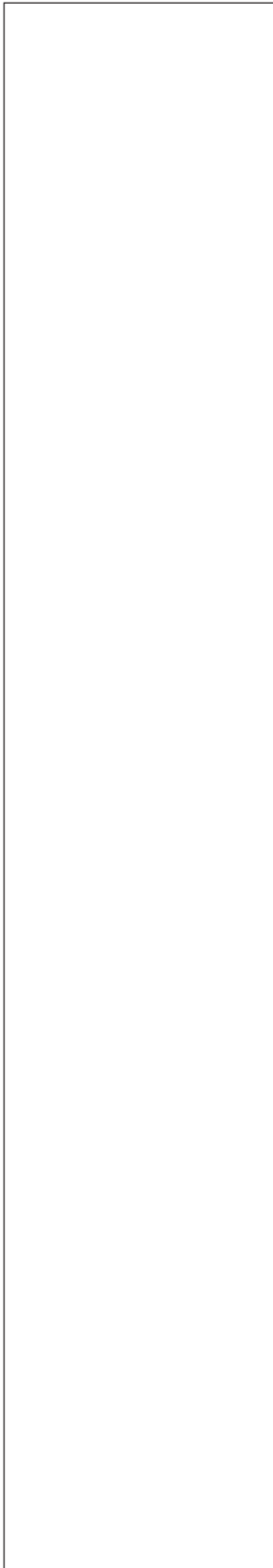

2.5mm ² Disconnect (switch) Terminal Blocks 2in 2out		Product Hierarchy 300005	
Type	Description	Order Code	Price
D2.5/5.SNBT.4L	2.5mm ² disconnect terminal (Grey body, short grey blade)	029013324	2.16

Accessories		Product Hierarchy 300008	
Type	Description	Order Code	Price
FED5.4L	End section for 2.5mm spring clamp terminals (Grey)	029104120	0.25
BJDL5.2	Jumper bar 2 Way (IP20)	029110223	0.29
BJDL5.3	Jumper bar 3 Way (IP20)	029110324	0.49
BJDL5.4	Jumper bar 4 Way (IP20)	029110425	0.87
BJDL5.5	Jumper bar 5 Way (IP20)	029110526	1.03
BJDL5.10	Jumper bar 10 Way (IP20)	029111026	1.77

2.5mm Fuse terminals		Product Hierarchy 300005	
Type	Description	Order Code	Price
D2.5/8.SFT.2L	Fuse terminal (flip top) for 5x20, 5x25mm fuse (Grey)	029009126	2.15
D2.5/8.SFDT.2L	Fuse terminal (flip top) for 5x20, 5x25mm fuse (Grey) with test socket & fuse blown indicator (24v)	029009421	6.47

Accessories		Product Hierarchy 300008	
Type	Description	Order Code	Price
FED8SF.2L	End section for 2.5mm spring clamp terminals (Grey)	029113117	0.27
BJDL8.2	Jumper bar 2 Way (IP20)	029112216	0.66

Terminal Blocks

SNK Terminal Blocks (price per 100)



4.0mm² Feed Through Terminal Blocks

Product Hierarchy 300010

Type	Description	Order Code	Price
ZS4	4mm² feed through terminal (Grey) [pack size = 50]	1SNK505010R0000	40.17
ZS4-BL	4mm² feed through terminal (Blue) [pack size = 50]	1SNK505020R0000	40.17
ZS4-PE	4mm² feed through terminal, Earth (Green / Yellow) [pack size = 20]	1SNK505150R0000	145.92
ZS4-OR	4mm² feed through terminal (Orange) [pack size = 50]	1SNK505030R0000	44.18
ZS4-YL	4mm² feed through terminal (Yellow) [pack size = 50]	1SNK505060R0000	44.18
ZS4-GN	4mm² feed through terminal (Green) [pack size = 50]	1SNK505061R0000	44.18
ZS4-RD	4mm² feed through terminal (Red) [pack size = 50]	1SNK505062R0000	44.18
ZS4-PR	4mm² feed through terminal (Purple) [pack size = 50]	1SNK505063R0000	44.18
ZS4-BR	4mm² feed through terminal (Brown) [pack size = 50]	1SNK505064R0000	44.18
ZS4-WH	4mm² feed through terminal (White) [pack size = 50]	1SNK505065R0000	44.18
ZS4-BK	4mm² feed through terminal (Black) [pack size = 50]	1SNK505066R0000	44.18

Accessories

ES4	End Section 4 - 16mm² (dark grey) [pack size = 20]	1SNK505910R0000	17.54
CS	Circuit Separator, fits into top of terminal (dark grey) [pack size = 20]	1SNK900101R0000	26.31
CS-R1	Circuit Separator 4 - 35mm² (dark grey) [pack size = 20]	1SNK900103R0000	26.31
TC5	Test connector (Dark Grey) [pack size = 10]	1SNK900200R0000	251.17
TC5-R1	Test Connector, end module (Dark Grey) [pack size = 10]	1SNK900201R0000	251.17
TP2	Adaptor for 2mm test plugs (Dark Grey) [pack size = 20]	1SNK900203R0000	231.85
TP4	Adaptor for 4mm test plugs (Dark Grey) [pack size = 20]	1SNK900205R0000	231.85
SHBS	Shield connector [pack size = 20]	1SNK900600R0000	36.06
PL5	Transparent cover (clear) [pack size = 10]	1SNK900618R0000	63.11
JB5-2	Jumper Bar 2 Pole, 5mm Pitch [pack size = 50]	1SNK905302R0000	35.07
JB5-3	Jumper Bar 3 Pole, 5mm Pitch [pack size = 50]	1SNK905303R0000	52.61
JB5-4	Jumper Bar 4 Pole, 5mm Pitch [pack size = 50]	1SNK905304R0000	70.14
JB5-5	Jumper Bar 5 Pole, 5mm Pitch [pack size = 50]	1SNK905305R0000	87.68
JB5-10	Jumper Bar 10 Pole, 5mm Pitch [pack size = 30]	1SNK905310R0000	175.35
JB5-50	Jumper Bar 50 Pole, 5mm Pitch [pack size = 10]	1SNK905350R0000	832.91
JB85-3	Jumper Bar 3 Pole, links 1 x 8mm pitch block with 2 x 5mm pitch blocks [pack size = 10]	1SNK900603R0000	78.25

Terminal Blocks

SNK Terminal Blocks (price per 100)



6.0mm ² Feed Through Terminal Blocks		Product Hierarchy 300010	
Type	Description	Order Code	Price
ZS6	6mm ² feed through terminal (Grey) [pack size = 50]	1SNK506010R0000	52.00
ZS6-BL	6mm ² feed through terminal (Blue) [pack size = 50]	1SNK506020R0000	61.39
ZS6-PE	6mm ² feed through terminal, Ground (Green / Yellow) [pack size = 20]	1SNK506150R0000	152.93
ZS6-OR	6mm ² feed through terminal (Orange) [pack size = 50]	1SNK506030R0000	67.53
ZS6-YL	6mm ² feed through terminal (Yellow) [pack size = 50]	1SNK506060R0000	67.53
ZS6-GN	6mm ² feed through terminal (Green) [pack size = 50]	1SNK506061R0000	67.53
ZS6-RD	6mm ² feed through terminal (Red) [pack size = 50]	1SNK506062R0000	67.53
ZS6-PR	6mm ² feed through terminal (Purple) [pack size = 50]	1SNK506063R0000	67.53
ZS6-BR	6mm ² feed through terminal (Brown) [pack size = 50]	1SNK506064R0000	67.53
ZS6-WH	6mm ² feed through terminal (White) [pack size = 50]	1SNK506065R0000	67.53
ZS6-BK	6mm ² feed through terminal (Black) [pack size = 50]	1SNK506066R0000	67.53
Accessories			
ES4	End Section 4 - 16mm ² (dark grey) [pack size = 20]	1SNK505910R0000	17.54
CS	Circuit Separator, fits into top of terminal (dark grey) [pack size = 20]	1SNK900101R0000	26.31
CS-R1	Circuit Separator 4 - 35mm ² (dark grey) [pack size = 20]	1SNK900103R0000	26.31
TC5	Test connector (Dark Grey) [pack size = 10]	1SNK900200R0000	251.17
TC5-R1	Test Connector, end module (Dark Grey) [pack size = 10]	1SNK900201R0000	251.17
ES-TC6	Spacer for test connector (Dark Grey) [pack size = 10]	1SNK900105R0000	19.32
TP2	Adaptor for 2mm test plugs (Dark Grey) [pack size = 20]	1SNK900203R0000	231.85
TP4	Adaptor for 4mm test plugs (Dark Grey) [pack size = 20]	1SNK900205R0000	231.85
SHBS	Shield connector [pack size = 20]	1SNK900600R0000	36.06
PL6	Transparent cover (Clear) [pack size = 10]	1SNK900619R0000	69.55
JB6-2	Jumper bar, 2 pole, 6mm pitch (Orange) [pack size = 50]	1SNK906302R0000	44.49
JB6-3	Jumper bar, 3 pole, 6mm pitch (Orange) [pack size = 50]	1SNK906303R0000	66.73
JB6-4	Jumper bar, 4 pole, 6mm pitch (Orange) [pack size = 50]	1SNK906304R0000	88.98
JB6-5	Jumper bar, 5 pole, 6mm pitch (Orange) [pack size = 50]	1SNK906305R0000	111.22
JB6-10	Jumper bar, 10 pole, 6mm pitch (Orange) [pack size = 20]	1SNK906310R0000	222.44
JB6-50	Jumper bar, 50 pole, 6mm pitch (Orange) [pack size = 10]	1SNK906350R0000	1056.60

Terminal Blocks

SNK Terminal Blocks (price per 100)



10mm² Feed Through Terminal Blocks

Type	Description	Order Code	Price
ZS10	10mm² feed through terminal (Grey) [pack size = 50]	1SNK508010R0000	62.08
ZS10-BL	10mm² feed through terminal (Blue) [pack size = 50]	1SNK508020R0000	78.93
ZS10-PE	10mm² feed through terminal, Earth.(Green / Yellow) [pack size = 20]	1SNK508150R0000	166.44
ZS10-OR	10mm² feed through terminal (Orange) [pack size = 50]	1SNK508030R0000	86.81
ZS10-YL	10mm² feed through terminal (Yellow) [pack size = 50]	1SNK508060R0000	86.81
ZS10-GN	10mm² feed through terminal (Green) [pack size = 50]	1SNK508061R0000	86.81
ZS10-RD	10mm² feed through terminal (Red) [pack size = 50]	1SNK508062R0000	86.81
ZS10-PR	10mm² feed through terminal (Purple) [pack size = 50]	1SNK508063R0000	86.81
ZS10-BR	10mm² feed through terminal (Brown) [pack size = 50]	1SNK508064R0000	86.81
ZS10-WH	10mm² feed through terminal (White) [pack size = 50]	1SNK508065R0000	86.81
ZS10-BK	10mm² feed through terminal (Black) [pack size = 50]	1SNK508066R0000	86.81

Accessories

ES4	End Section 4 - 16mm² (dark grey) [pack size = 20]	1SNK505910R0000	17.54
CS	Circuit Separator, fits into top of terminal (dark grey) [pack size = 20]	1SNK900101R0000	26.31
CS-R1	Circuit Separator 4 - 35mm² (dark grey) [pack size = 20]	1SNK900103R0000	26.31
TC5	Test connector (Dark Grey) [pack size = 10]	1SNK900200R0000	251.17
TC5-R1	Test Connector, end module (Dark Grey) [pack size = 10]	1SNK900201R0000	251.17
ES-TC8	Spacer for test connector (Dark Grey) [pack size = 10]	1SNK900104R0000	19.32
TP2	Adaptor for 2mm test plugs (Dark Grey) [pack size = 20]	1SNK900203R0000	231.85
TP4	Adaptor for 4mm test plugs (Dark Grey) [pack size = 20]	1SNK900205R0000	231.85
SHBS	Shield connector [pack size = 20]	1SNK900600R0000	36.06
PL8	Transparent cover (Clear) [pack size = 10]	1SNK900620R0000	77.28
JB8-2	Jumper bar, 2 pole, 8mm pitch (Orange) [pack size = 50]	1SNK908302R0000	43.67
JB8-3	Jumper bar, 3 pole, 8mm pitch (Orange) [pack size = 50]	1SNK908303R0000	65.51
JB8-4	Jumper bar, 4 pole, 8mm pitch (Orange) [pack size = 50]	1SNK908304R0000	87.34
JB8-5	Jumper bar, 5 pole, 8mm pitch (Orange) [pack size = 40]	1SNK908305R0000	109.18
JB8-10	Jumper bar, 10 pole, 8mm pitch (Orange) [pack size = 20]	1SNK908310R0000	218.36

Terminal Blocks

SNK Terminal Blocks (price per 100)



16mm² Feed Through Terminal Blocks

Product Hierarchy 300010

Type	Description	Order Code	Price
ZS16	16mm² feed through terminal (Grey) [pack size = 50]	1SNK510010R0000	89.79
ZS16-BL	16mm² feed through terminal (Blue) [pack size = 50]	1SNK510020R0000	105.23
ZS16-PE	16mm² feed through terminal, Earth, (Green / Yellow) [pack size = 20]	1SNK510150R0000	227.91
ZS16-OR	16mm² feed through terminal (Orange) [pack size = 50]	1SNK510030R0000	105.23

Accessories

ES4	End Section 4 - 16mm² (dark grey) [pack size = 20]	1SNK505910R0000	17.54
CS	Circuit Separator, fits into top of terminal (dark grey) [pack size = 20]	1SNK900101R0000	26.31
CS-R1	Circuit Separator 4 - 35mm² (dark grey) [pack size = 20]	1SNK900103R0000	26.31
TP2	Adaptor for 2mm test plugs (Dark Grey) [pack size = 20]	1SNK900203R0000	231.85
TP4	Adaptor for 4mm test plugs (Dark Grey) [pack size = 20]	1SNK900205R0000	231.85
PL10	Transparent cover (Clear) [pack size = 10]	1SNK900621R0000	81.79
JB10-2	Jumper bar, 2 pole, 10mm pitch (Orange) [pack size = 50]	1SNK910302R0000	69.00
JB10-3	Jumper bar, 3 pole, 10mm pitch (Orange) [pack size = 50]	1SNK910303R0000	103.50
JB10-4	Jumper bar, 4 pole, 10mm pitch (Orange) [pack size = 40]	1SNK910304R0000	138.00
JB10-5	Jumper bar, 5 pole, 10mm pitch (Orange) [pack size = 30]	1SNK910305R0000	172.50
JB10-10	Jumper bar, 10 pole, 10mm pitch (Orange) [pack size = 20]	1SNK910310R0000	345.00

35mm² Feed Through Terminal Blocks

Product Hierarchy 300010

Type	Description	Order Code	Price
ZS35	35mm² feed through terminal (Grey) [pack size = 20]	1SNK516010R0000	213.09
ZS35-BL	35mm² feed through terminal (Blue) [pack size = 20]	1SNK516020R0000	236.85
ZS35-PE	35mm² feed through terminal, Ground (Green / Yellow) [pack size = 20]	1SNK516150R0000	280.77
ZS35-OR	35mm² feed through terminal (Orange) [pack size = 20]	1SNK516030R0000	236.85

Accessories

PL16	Transparent cover (Clear) [pack size = 10]	1SNK900622R0000	86.94
JB16-2	Jumper bar, 2 pole, 16mm pitch [pack size = 10]	1SNK916302R0000	118.50
JB16-3	Jumper bar, 3 pole, 16mm pitch [pack size = 10]	1SNK916303R0000	177.75
JB16-4	Jumper bar, 4 pole, 16mm pitch [pack size = 10]	1SNK916304R0000	237.00
JB16-5	Jumper bar, 5 pole, 16mm pitch [pack size = 10]	1SNK916305R0000	296.25
JB16-10	Jumper bar, 10 pole, 16mm pitch [pack size = 10]	1SNK916310R0000	592.50

Terminal Blocks

SNK Terminal Blocks (price per 100)

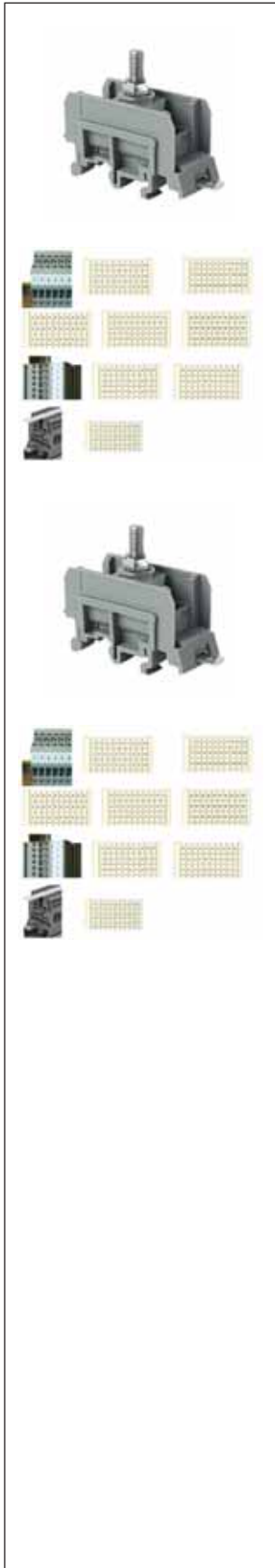

70mm ² Feed Through Terminal Blocks		Product Hierarchy 300010	
Type	Description	Order Code	Price
ZS70	70mm ² feed through terminal block (Grey) [pack size = 10]	1SNK522010R0000	577.60
ZS70-BL	70mm ² feed through terminal block (Blue) [pack size = 10]	1SNK522020R0000	876.85
ZS70-PE	70mm ² feed through terminal block, Ground (Green / Yellow) [pack size =	1SNK522150R0000	1135.00

Accessories			
JB22-2	Jumper bar, 2 pole, 22mm pitch [pack size = 5]	1SNK922302R0000	281.90
JB22-3	Jumper bar, 3 pole, 22mm pitch [pack size = 5]	1SNK922303R0000	422.85
JB22-5	Jumper bar, 5 pole, 22mm pitch [pack size = 5]	1SNK922305R0000	704.75
JB22-10	Jumper bar, 10 pole, 22mm pitch [pack size = 5]	1SNK922310R0000	1409.50

95mm ² Feed Through Terminal Blocks		Product Hierarchy 300010	
Type	Description	Order Code	Price
ZS95	95mm ² feed through terminal (Grey) [pack size = 10]	1SNK526010R0000	1120.05
ZS95-BL	95mm ² feed through terminal (Blue) [pack size = 10]	1SNK526020R0000	1120.05
ZS95-PE	95mm ² feed through terminal, Ground (Green / Yellow) [pack size = 10]	1SNK526150R0000	1386.05

Accessories			
JB26-2	Jumper bar, 2 pole, 26mm pitch [pack size = 5]	1SNK926302R0000	473.35
JB26-3	Jumper bar, 3 pole, 26mm pitch [pack size = 5]	1SNK926303R0000	710.03
JB26-5	Jumper bar, 5 pole, 26mm pitch [pack size = 5]	1SNK926305R0000	1183.38
JB26-10	Jumper bar, 10 pole, 26mm pitch [pack size = 5]	1SNK926310R0000	2366.75

Terminal Blocks

SNK Terminal Blocks (price per 100)



4.0mm² Double Deck Terminal Blocks

Product Hierarchy 300010

Type	Description	Order Code	Price
ZS4-D2	4mm² double deck terminal, 2 circuits (Grey) [pack size = 50]	1SNK505210R0000	104.50
ZS4-D1	4mm² double deck terminal, 1 circuit (Grey) [pack size = 50]	1SNK505211R0000	256.50
ZS4-D2-BL	4mm² double deck terminal, 2 circuits (Blue) [pack size = 50]	1SNK505220R0000	104.50
ZS4-D2-OR	4mm² double deck terminal, 2 circuits (Orange) [pack size = 50]	1SNK505230R0000	109.73

Accessories

ES4-D2	End Section for double deck terminals [pack size = 20]	1SNK505960R0000	35.07
TC5	Test connector (Dark Grey) [pack size = 10]	1SNK900200R0000	251.17
TC5-R1	Test Connector, end module (Dark Grey) [pack size = 10]	1SNK900201R0000	251.17
TP2	Adaptor for 2mm test plugs (Dark Grey) [pack size = 20]	1SNK900203R0000	231.85
TP4	Adaptor for 4mm test plugs (Dark Grey) [pack size = 20]	1SNK900205R0000	231.85
SHB	Shield connector [pack size = 20]	1SNK900602R0000	92.09
JB5-2	Jumper Bar 2 Pole, 5mm Pitch [pack size = 50]	1SNK905302R0000	35.07
JB5-3	Jumper Bar 3 Pole, 5mm Pitch [pack size = 50]	1SNK905303R0000	52.61
JB5-4	Jumper Bar 4 Pole, 5mm Pitch [pack size = 50]	1SNK905304R0000	70.14
JB5-5	Jumper Bar 5 Pole, 5mm Pitch [pack size = 50]	1SNK905305R0000	87.68
JB5-10	Jumper Bar 10 Pole, 5mm Pitch [pack size = 30]	1SNK905310R0000	175.35

6.0mm² Double Deck Terminal Blocks

Product Hierarchy 300010

Type	Description	Order Code	Price
ZS6-D2	6mm² double deck terminal, 2 circuits (Grey) [pack size = 50]	1SNK506210R0000	136.82
ZS6-D1	6mm² double deck terminal, 1 circuit (Grey) [pack size = 50]	1SNK506211R0000	234.14
ZS6-D2-BL	6mm² double deck terminal, 2 circuits (Blue) [pack size = 50]	1SNK506220R0000	136.82
ZS6-D2-OR	6mm² double deck terminal, 2 circuits (Orange) [pack size = 50]	1SNK506230R0000	142.29

Accessories

ES4-D2	End Section for double deck terminals [pack size = 20]	1SNK505960R0000	35.07
TC5	Test connector (Dark Grey) [pack size = 10]	1SNK900200R0000	251.17
TC5-R1	Test Connector, end module (Dark Grey) [pack size = 10]	1SNK900201R0000	251.17
ES-TC6	Spacer for test connector (Dark Grey) [pack size = 10]	1SNK900105R0000	19.32
TP2	Adaptor for 2mm test plugs (Dark Grey) [pack size = 20]	1SNK900203R0000	231.85
TP4	Adaptor for 4mm test plugs (Dark Grey) [pack size = 20]	1SNK900205R0000	231.85
SHB	Shield connector [pack size = 20]	1SNK900602R0000	92.09
JB6-2	Jumper bar, 2 pole, 6mm pitch (Orange) [pack size = 50]	1SNK906302R0000	44.49
JB6-3	Jumper bar, 3 pole, 6mm pitch (Orange) [pack size = 50]	1SNK906303R0000	66.73
JB6-4	Jumper bar, 4 pole, 6mm pitch (Orange) [pack size = 50]	1SNK906304R0000	88.98
JB6-5	Jumper bar, 5 pole, 6mm pitch (Orange) [pack size = 50]	1SNK906305R0000	111.22
JB6-10	Jumper bar, 10 pole, 6mm pitch (Orange) [pack size = 20]	1SNK906310R0000	222.44

Terminal Blocks

SNK Terminal Blocks (price per 100)



4.0mm ² Disconnect (Blade) Terminal Block (Same profile as ZS4)		Product Hierarchy 300010	
Type	Description	Order Code	Price
ZS4-S	4mm ² disconnect terminal (Grey) [pack size = 50]	1SNK505310R0000	136.82
ZS4-S-BL	4mm ² disconnect terminal (Blue) [pack size = 50]	1SNK505320R0000	136.82
ZS4-S-OR	4mm ² disconnect terminal (Orange) [pack size = 50]	1SNK505330R0000	142.29
ZS4-S-T2	4mm ² disconnect terminal with 2mm test sockets (Grey) [pack size = 50]	1SNK505311R0000	171.17
ZS4-S-T2-BL	4mm ² disconnect terminal with 2mm test sockets (Blue) [pack size = 50]	1SNK505321R0000	171.17
ZS4-S-T2-OR	4mm ² disconnect terminal with 2mm test sockets (Orange) [pack size = 50]	1SNK505331R0000	178.01
ZS4-S-T2.3	4mm ² disconnect terminal with 2.3mm test sockets (Grey) [pack size = 50]	1SNK505312R0000	171.17
Accessories			
ES4	End Section 4 - 16mm ² (dark grey) [pack size = 20]	1SNK505910R0000	17.54
CS-R1	Circuit Separator 4 - 35mm ² (dark grey) [pack size = 20]	1SNK900103R0000	26.31
SHBS	Shield connector [pack size = 20]	1SNK900600R0000	36.06
PL5	Transparent cover (clear) [pack size = 10]	1SNK900618R0000	63.11

4.0mm ² Disconnect (Blade) Terminal Block		Product Hierarchy 300010	
Type	Description	Order Code	Price
ZS4-S-R1	4mm ² disconnect terminal (Grey) [pack size = 50]	1SNK506310R0000	205.23
ZS4-S-R1-BL	4mm ² disconnect terminal (Blue) [pack size = 50]	1SNK506320R0000	205.23
ZS4-S-R1-OR	4mm ² disconnect terminal (Orange) [pack size = 50]	1SNK506330R0000	213.44
Accessories			
TC5	Test connector (Dark Grey) [pack size = 10]	1SNK900200R0000	251.17
TC5-R1	Test Connector, end module (Dark Grey) [pack size = 10]	1SNK900201R0000	251.17
ES-TC6	Spacer for test connector (Dark Grey) [pack size = 10]	1SNK900105R0000	19.32
TP2	Adaptor for 2mm test plugs (Dark Grey) [pack size = 20]	1SNK900203R0000	231.85
TP4	Adaptor for 4mm test plugs (Dark Grey) [pack size = 20]	1SNK900205R0000	231.85
JB6-2	Jumper bar, 2 pole, 6mm pitch (Orange) [pack size = 50]	1SNK906302R0000	44.49
JB6-3	Jumper bar, 3 pole, 6mm pitch (Orange) [pack size = 50]	1SNK906303R0000	66.73
JB6-4	Jumper bar, 4 pole, 6mm pitch (Orange) [pack size = 50]	1SNK906304R0000	88.98
JB6-5	Jumper bar, 5 pole, 6mm pitch (Orange) [pack size = 50]	1SNK906305R0000	111.22
JB6-10	Jumper bar, 10 pole, 6mm pitch (Orange) [pack size = 20]	1SNK906310R0000	222.44

Terminal Blocks

SNK Terminal Blocks (price per 100)



4.0mm² Disconnect (Blade) Terminal Block

Product Hierarchy 300010

Type	Description	Order Code	Price
ZS4-S-T2-R1	4mm ² disconnect terminal with 2mm test sockets (Grey) [pack size = 50]	1SNK506311R0000	239.57
ZS4-S-T2-R1-BL	4mm ² disconnect terminal with 2mm test sockets (Blue) [pack size = 50]	1SNK506321R0000	239.57
ZS4-S-T2-R1-OR	4mm ² disconnect terminal with 2mm test sockets (Orange) [pack size = 50]	1SNK506331R0000	249.16
ZS4-S-T2.3-R1	4mm ² disconnect terminal with 2.3mm test sockets (Grey) [pack size = 50]	1SNK506312R0000	239.57

Accessories

TC5	Test connector (Dark Grey) [pack size = 10]	1SNK900200R0000	251.17
TC5-R1	Test Connector, end module (Dark Grey) [pack size = 10]	1SNK900201R0000	251.17
ES-TC6	Spacer for test connector (Dark Grey) [pack size = 10]	1SNK900105R0000	19.32
JB6-2	Jumper bar, 2 pole, 6mm pitch (Orange) [pack size = 50]	1SNK906302R0000	44.49
JB6-3	Jumper bar, 3 pole, 6mm pitch (Orange) [pack size = 50]	1SNK906303R0000	66.73
JB6-4	Jumper bar, 4 pole, 6mm pitch (Orange) [pack size = 50]	1SNK906304R0000	88.98
JB6-5	Jumper bar, 5 pole, 6mm pitch (Orange) [pack size = 50]	1SNK906305R0000	111.22
JB6-10	Jumper bar, 10 pole, 6mm pitch (Orange) [pack size = 20]	1SNK906310R0000	222.44

4.0mm² Disconnect (Blade) Terminal Block

Product Hierarchy 300010

Type	Description	Order Code	Price
ZS4-SP	4mm ² disconnect terminal (plug sold separately) (Grey) [pack size = 50]	1SNK505313R0000	128.23
ZS4-SPT2	4mm ² disconnect terminal with 2mm test sockets (plug sold separately) (Grey) [pack size = 50]	1SNK505314R0000	162.58

Accessories

ES4	End Section 4 - 16mm ² (dark grey) [pack size = 20]	1SNK505910R0000	17.54
PG5	Component plug (Grey) [pack size = 20]	1SNK900401R0000	106.26
PG5-R1	Plug with integral linking bar (Orange) [pack size = 25]	1SNK900402R0000	86.94
SHBS	Shield connector [pack size = 20]	1SNK900600R0000	36.06

Terminal Blocks

SNK Terminal Blocks (price per 100)



4.0mm² Disconnect (Pluggable) Terminal Block (Same profile as ZS4)

Product Hierarchy 300010

Type	Description	Order Code	Price
ZS4-SP-R1	4mm ² disconnect terminal (plug sold separately) (Grey) [pack size = 50]	1SNK506313R0000	196.64
ZS4-SP-T2-R1	4mm ² disconnect terminal with 2mm test sockets (plug sold separately) (Grey) [pack size = 50]	1SNK506314R0000	230.99

Accessories

PG5	Component plug (Grey) [pack size = 20]	1SNK900401R0000	106.26
PG5-R1	Plug with integral linking bar (Orange) [pack size = 25]	1SNK900402R0000	86.94
TC5	Test connector (Dark Grey) [pack size = 10]	1SNK900200R0000	251.17
TC5-R1	Test Connector, end module (Dark Grey) [pack size = 10]	1SNK900201R0000	251.17
ES-TC6	Spacer for test connector (Dark Grey) [pack size = 10]	1SNK900105R0000	19.32
JB6-2	Jumper bar, 2 pole, 6mm pitch (Orange) [pack size = 50]	1SNK906302R0000	44.49
JB6-3	Jumper bar, 3 pole, 6mm pitch (Orange) [pack size = 50]	1SNK906303R0000	66.73
JB6-4	Jumper bar, 4 pole, 6mm pitch (Orange) [pack size = 50]	1SNK906304R0000	88.98
JB6-5	Jumper bar, 5 pole, 6mm pitch (Orange) [pack size = 50]	1SNK906305R0000	111.22
JB6-10	Jumper bar, 10 pole, 6mm pitch (Orange) [pack size = 20]	1SNK906310R0000	222.44

4.0mm² Disconnect (Pluggable) Terminal Block (Same profile as ZS4-SF)

Product Hierarchy 300010

Type	Description	Order Code	Price
ZS4-S-R2	4mm ² disconnect terminal (Grey / Orange) [pack size = 50]	1SNK506414R0000	250.62

Accessories

TC5	Test connector (Dark Grey) [pack size = 10]	1SNK900200R0000	251.17
TC5-R1	Test Connector, end module (Dark Grey) [pack size = 10]	1SNK900201R0000	251.17
ES-TC6	Spacer for test connector (Dark Grey) [pack size = 10]	1SNK900105R0000	19.32
TP2	Adaptor for 2mm test plugs (Dark Grey) [pack size = 20]	1SNK900203R0000	231.85
TP4	Adaptor for 4mm test plugs (Dark Grey) [pack size = 20]	1SNK900205R0000	231.85
JB6-2	Jumper bar, 2 pole, 6mm pitch (Orange) [pack size = 50]	1SNK906302R0000	44.49
JB6-3	Jumper bar, 3 pole, 6mm pitch (Orange) [pack size = 50]	1SNK906303R0000	66.73
JB6-4	Jumper bar, 4 pole, 6mm pitch (Orange) [pack size = 50]	1SNK906304R0000	88.98
JB6-5	Jumper bar, 5 pole, 6mm pitch (Orange) [pack size = 50]	1SNK906305R0000	111.22
JB6-10	Jumper bar, 10 pole, 6mm pitch (Orange) [pack size = 20]	1SNK906310R0000	222.44

Terminal Blocks

SNK Terminal Blocks (price per 100)



4.0mm ² Disconnect (Lever) Terminal Block (Same profile as ZS4-SF1)		Product Hierarchy 300010	
Type	Description	Order Code	Price
ZS4-S-R3	4mm ² disconnect terminal with integral linking bar (Grey / Orange) [pack size = 50]	1SNK508416R0000	182.61
Accessories			
ES4-SF	End Section (Dark Grey) [pack size = 20]	1SNK508960R0000	19.32

4.0mm ² 5x20mm Fuse Terminal		Product Hierarchy 300010	
Type	Description	Order Code	Price
ZS4-SF	4mm ² 5x20mm Fuse Terminal (Grey / Dark Grey) [pack size = 50]	1SNK506410R0000	183.35
ZS4-SF-R1	4mm ² 5x20mm Fuse Terminal with 24-60V LED blown fuse indicator (Grey / Dark Grey) [pack size = 50]	1SNK506412R0000	554.14
ZS4-SF-R3	4mm ² 5x20mm Fuse Terminal with 115-250V LED blown fuse indicator (Grey / Dark Grey) [pack size = 50]	1SNK506415R0000	554.14
Accessories			
TC5	Test connector (Dark Grey) [pack size = 10]	1SNK900200R0000	251.17
TC5-R1	Test Connector, end module (Dark Grey) [pack size = 10]	1SNK900201R0000	251.17
ES-TC6	Spacer for test connector (Dark Grey) [pack size = 10]	1SNK900105R0000	19.32
TP2	Adaptor for 2mm test plugs (Dark Grey) [pack size = 20]	1SNK900203R0000	231.85
TP4	Adaptor for 4mm test plugs (Dark Grey) [pack size = 20]	1SNK900205R0000	231.85
JB6-2	Jumper bar, 2 pole, 6mm pitch (Orange) [pack size = 50]	1SNK906302R0000	44.49
JB6-3	Jumper bar, 3 pole, 6mm pitch (Orange) [pack size = 50]	1SNK906303R0000	66.73
JB6-4	Jumper bar, 4 pole, 6mm pitch (Orange) [pack size = 50]	1SNK906304R0000	88.98
JB6-5	Jumper bar, 5 pole, 6mm pitch (Orange) [pack size = 50]	1SNK906305R0000	111.22
JB6-10	Jumper bar, 10 pole, 6mm pitch (Orange) [pack size = 20]	1SNK906310R0000	222.44

Terminal Blocks

SNK Terminal Blocks (price per 100)



4.0mm² 5x20mm Fuse Terminal		Product Hierarchy 300010	
Type	Description	Order Code	Price
ZS4-SF-T2	4mm² 5x20mm Fuse Terminal with 2mm test sockets (Grey / Dark Grey) [pack size = 50]	1SNK506411R0000	262.19
ZS4-SF-R2	4mm² 5x20mm Fuse Terminal with 2mm test sockets, 24-60V LED blown fuse indicator (Grey / Dark Grey) [pack size = 50]	1SNK506413R0000	360.65
ZS4-SF-R4	4mm² 5x20mm Fuse Terminal with 2mm test sockets, 115-250V LED blown fuse indicator (Grey / Dark Grey) [pack size = 50]	1SNK506416R0000	588.49

Accessories			
Type	Description	Order Code	Price
TC5	Test connector (Dark Grey) [pack size = 10]	1SNK900200R0000	251.17
TC5-R1	Test connector, end module (Dark Grey) [pack size = 10]	1SNK900201R0000	251.17
ES-TC6	Spacer for test connector (Dark Grey) [pack size = 10]	1SNK900105R0000	19.32
JB6-2	Jumper bar, 2 pole, 6mm pitch (Orange) [pack size = 50]	1SNK906302R0000	44.49
JB6-3	Jumper bar, 3 pole, 6mm pitch (Orange) [pack size = 50]	1SNK906303R0000	66.73
JB6-4	Jumper bar, 4 pole, 6mm pitch (Orange) [pack size = 50]	1SNK906304R0000	88.98
JB6-5	Jumper bar, 5 pole, 6mm pitch (Orange) [pack size = 50]	1SNK906305R0000	111.22
JB6-10	Jumper bar, 10 pole, 6mm pitch (Orange) [pack size = 20]	1SNK906310R0000	222.44

4.0mm² 5x20mm Fuse Terminal		Product Hierarchy 300010	
Type	Description	Order Code	Price
ZS4-SF1	4mm² 5x20mm / 5x25mm Fuse Terminal (Grey / Dark Grey) [pack size = 50]	1SNK508410R0000	184.00
ZS4-SF1-R1	4mm² 5x20mm / 5x25mm Fuse Terminal, 24-60V blown fuse indicator (Grey / Dark Grey) [pack size = 50]	1SNK508412R0000	492.32
ZS4-SF1-R3	4mm² 5x20mm / 5x25mm Fuse Terminal, 115-250V blown fuse indicator (Grey / Dark Grey) [pack size = 50]	1SNK508414R0000	492.32
ZS4-SF1-T2	4mm² 5x20mm / 5x25mm Fuse Terminal with 2mm test sockets (Grey / Dark Grey) [pack size = 50]	1SNK508411R0000	200.36
ZS4-SF1-R2	4mm² 5x20mm / 5x25mm Fuse Terminal with 2mm test sockets, 24-60V blown fuse indicator (Grey / Dark Grey) [pack size = 50]	1SNK508413R0000	526.66
ZS4-SF1-R4	4mm² 5x20mm / 5x25mm Fuse Terminal with 2mm test sockets, 115-250V blown fuse indicator (Grey / Dark Grey) [pack size = 50]	1SNK508415R0000	526.66
ZS4-R1	4mm² feed through terminal, (same profile as ZS4-SF1) (Grey) [pack size = 50]	1SNK508013R0000	109.57

Accessories			
Type	Description	Order Code	Price
ES4-SF	End Section (Dark Grey) [pack size = 20]	1SNK508960R0000	19.32

Terminal Blocks

SNK Terminal Blocks (price per 100)



General Accessories (End Stops and Protective Covers)

Product Hierarchy 300010

Type	Description	Order Code	Price
BAM3	TS35 rail screw down end stop (Dark Grey) [pack size = 50]	1SNK900001R0000	35.97
BAZH1	TS35 rail screw down tall end stop (Dark Grey) [pack size = 20]	1SNK900102R0000	106.26
KCO	Protective cover mounting kit (2 x BAZH1 + seals) (Dark Grey) [pack size = 1]	1SNK900624R0000	244.40
CO	77mm x 30mm x 1m protective cover	1SNK900604R0000	805.02

General Accessories (End Stops and Protective Covers)

LH	10mm label holder (fits into end stops) (Dark Grey) [pack size = 50]	1SNK900605R0000	13.52
MCLH	Card of 36 labels 30x8.8mm for LH label holder (White) [pack size = 25]	1SNK900630R0000	483.01
MCLH-YL	Card of 36 labels 30x8.8mm for LH label holder (Yellow) [pack size = 25]	1SNK900633R0000	472.28
LH-R1	10mm label holder (fits into end stops) (Dark Grey) [pack size = 50]	1SNK900607R0000	21.90
MCLH-R1	Card of 15 labels 35.35x17.65mm for LH-R1 label holder (White) [pack size = 25]	1SNK900631R0000	721.30
MCLH-R1-YL	Card of 15 labels 35.35x17.65mm for LH-R1 label holder (Yellow) [pack size = 25]	1SNK900634R0000	705.27
SAT	210 x 148mm self adhesive label sheet (white) [pack size = 5]	1SNK900623R0000	136.44
SAT5	Sheet of 240 9 x 5.2mm self adhesive markers (White) [pack size = 5]	1SNK900614R0000	162.67
SAT6	Sheet of 240 9 x 5.8mm self adhesive markers (White) [pack size = 5]	1SNK900615R0000	162.67
SAT8	Sheet of 160 9 x 7.8mm self adhesive markers (White) [pack size = 5]	1SNK900616R0000	162.67
MC512	MC512 marker card - contains 45 blank 5mm x 12mm tags (white) [pack size = 22]	1SNK140000R0000	86.58
MC512PA	MC512PA marker card - contains 100 blank 5 x 12mm tags (white) [pack size = 20]	1SNK149999R0000	99.70
MC512PA	MC512PA marker card - horizontal 10 x [0->9]	1SNK140091R0000	158.00
MC512PA	MC512PA marker card - horizontal 10 x [1->10]	1SNK140011R0000	158.00
MC512PA	MC512PA marker card - horizontal 10 x [11->20]	1SNK140021R0000	158.00
MC512PA	MC512PA marker card - horizontal 10 x [21->30]	1SNK140031R0000	158.00
MC512PA	MC512PA marker card - horizontal 10 x [31->40]	1SNK140041R0000	158.00
MC512PA	MC512PA marker card - horizontal 10 x [41->50]	1SNK140051R0000	158.00
MC512PA	MC512PA marker card - horizontal 10 x [51->60]	1SNK140061R0000	158.00
MC512PA	MC512PA marker card - horizontal 10 x [61->70]	1SNK140071R0000	158.00
MC512PA	MC512PA marker card - horizontal 10 x [71->80]	1SNK140081R0000	158.00
MC512PA	MC512PA marker card - horizontal 10 x [81->90]	1SNK140083R0000	158.00
MC512PA	MC512PA marker card - horizontal 10 x [91->100]	1SNK140101R0000	158.00
MC512PA	MC512PA marker card - horizontal [1->100]	1SNK145011R0000	158.00
MC512PA	MC512PA marker card - horizontal 100 x 	1SNK148041R0000	158.00
MC512PA	MC512PA marker card - horizontal 20 x [L1 L2 L3 N PE]	1SNK149001R0000	158.00

Terminal Blocks

SNK Terminal Blocks (price per 100)

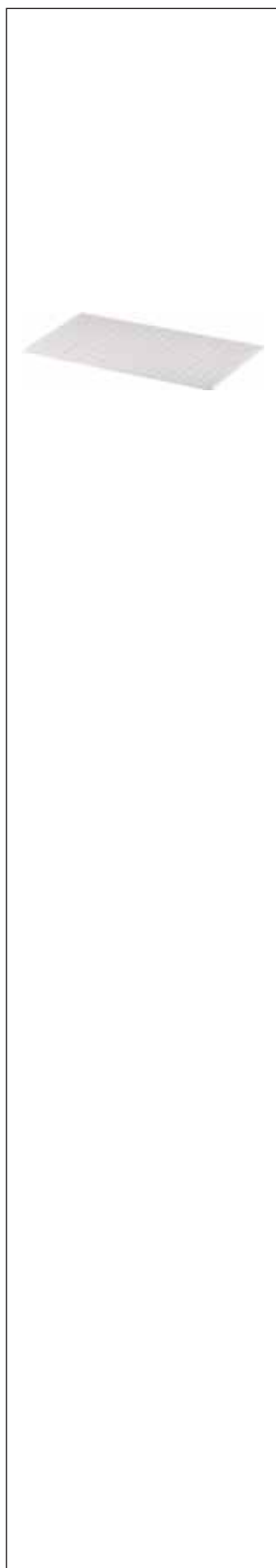

General Accessories (Markers)		Product Hierarchy 300010	
Type	Description	Order Code	Price
MC612	MC612 marker card - contains 39 blank 6mm x 12mm tags (white) [pack size = 22]	1SNK150000R0000	94.81
MC612PA	MC612PA marker card - contains 100 blank 6 x 12mm tags (white) [pack size = 20]	1SNK159999R0000	114.66
MC612PA	MC612PA marker card - horizontal 10 x [1->10]	1SNK150011R0000	173.00
MC612PA	MC612PA marker card - horizontal 10 x [11->20]	1SNK150021R0000	173.00
MC612PA	MC612PA marker card - horizontal 10 x [21->30]	1SNK150031R0000	173.00
MC612PA	MC612PA marker card - horizontal 10 x [31->40]	1SNK150041R0000	173.00
MC612PA	MC612PA marker card - horizontal 10 x [41->50]	1SNK150051R0000	173.00
MC612PA	MC612PA marker card - horizontal 10 x [51->60]	1SNK150061R0000	173.00
MC612PA	MC612PA marker card - horizontal 10 x [61->70]	1SNK150071R0000	173.00
MC612PA	MC612PA marker card - horizontal 10 x [71->80]	1SNK150081R0000	173.00
MC612PA	MC612PA marker card - horizontal 10 x [91->100]	1SNK150101R0000	173.00
MC612PA	MC612PA marker card - horizontal [1->100]	1SNK155011R0000	173.00
MC612PA	MC612PA marker card - horizontal 100 x	1SNK158041R0000	173.00
MC612PA	MC612PA marker card - horizontal 20 x [L ₃ N PE]	1SNK159001R0000	173.00
MC812	MC812 marker card - contains 30 blank 8mm x 12mm tags (white) [pack size = 22]	1SNK160000R0000	114.40
MC812PA	MC812PA marker card - contains 100 blank 6 x 12mm tags (white) [pack size = 20]	1SNK169999R0000	149.56
MC812PA	MC812PA marker card - horizontal 10 x [1->10]	1SNK160011R0000	208.00
MC812PA	MC812PA marker card - horizontal 10 x [11->20]	1SNK160021R0000	208.00
MC812PA	MC812PA marker card - horizontal 10 x [21->30]	1SNK160031R0000	208.00
MC812PA	MC812PA marker card - horizontal 10 x [31->40]	1SNK160041R0000	208.00
MC812PA	MC812PA marker card - horizontal 10 x [41->50]	1SNK160051R0000	208.00
MC812PA	MC812PA marker card - horizontal 10 x [51->60]	1SNK160061R0000	208.00
MC812PA	MC812PA marker card - horizontal 10 x [61->70]	1SNK160071R0000	208.00
MC812PA	MC812PA marker card - horizontal 10 x [71->80]	1SNK160081R0000	208.00
MC812PA	MC812PA marker card - horizontal 10 x [91->100]	1SNK160101R0000	208.00

Terminal Blocks

ADO Terminals

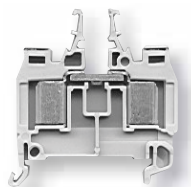

1mm² ADO Feed Through Terminal Blocks

Product Hierarchy 300006

Type	Description	Order Code	Price
D1/5.ADO	1mm ² feed through terminal, ADO-ADO (Grey)	1SNA199563R2400	0.57
D1/5.PADO	1mm ² feed through terminal, Ground, ADO-ADO (Green / Yellow)	1SNA399031R2200	2.15
D1/5.ADO	1mm ² feed through terminal, ADO-ADO (Orange)	1SNA199564R2500	0.57

Accessories

Product Hierarchy 300008

Type	Description	Order Code	Price
D2,5/5.ADO	1mm ² ADO - 2.5mm ² screw clamp feed through terminal (Grey)	1SNA199554R2300	0.57
FEMAD3	End section (Grey)	1SNA199341R0500	0.28
FEMAD3	End section (Yellow)	1SNA199343R0700	0.28
FC2	Test Plug 2mm diameter	1SNA007865R2600	1.21
BJMI5	Jumper bar - 2 pole (IP20)	1SNA176278R1600	1.04
BJMI5	Jumper bar - 3 pole (IP20)	1SNA176279R1700	1.15
BJMI5	Jumper bar - 4 pole (IP20)	1SNA176280R0500	1.34
BJMI5	Jumper bar - 5 pole (IP20)	1SNA176281R2200	1.71
BJMI5	Jumper bar - 10 pole (IP20)	1SNA176282R2300	2.86
EL6	Connector Plate to link two jumper bars together	1SNA173627R2100	0.22
CBM5	Screen Bar 0.5mm thickness	1SNA178745R1400	0.34
CBM8	Screen Bar 0.8mm thickness	1SNA178746R1500	0.43

Terminal Blocks

ADO Terminals

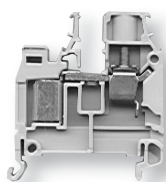
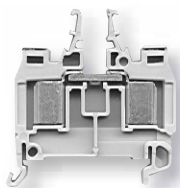

1.5mm² ADO Feed Through Terminal Blocks

Product Hierarchy 300006

Type	Description	Order Code	Price
D1,5/6.ADO	1.5mm² ADO feed through terminal (Grey)	1SNA199051R2600	0.57
D1,5/6.N.ADO	1.5mm² ADO feed through terminal (Blue)	1SNA199053R2000	0.59
D1,5/6.PADO	1.5mm² ADO feed through terminal, Ground (Green / Yellow)	1SNA199098R2600	2.15
D1,5/6.ADO	1.5mm² ADO feed through terminal (Red)	1SNA199081R1500	0.57
D4/6.ADO	1.5mm² ADO - 4mm² screw clamp feed through terminal (Grey)	1SNA199034R1500	0.57
D4/6.N.ADO	1.5mm² ADO - 4mm² screw clamp feed through terminal (Blue)	1SNA199036R1700	0.59
D4/6.PADO	1.5mm² ADO - 4mm² screw clamp feed through terminal, Ground (Green / Yellow)	1SNA199050R0100	2.07
D4/6.ADO	1.5mm² ADO - 4mm² screw clamp feed through terminal (Orange)	1SNA199035R1600	0.57
D4/6.ADO	1.5mm² ADO - 4mm² screw clamp feed through terminal (Red)	1SNA199069R0000	0.57

Accessories

Product Hierarchy 300008

Type	Description	Order Code	Price
FEMAD3	End section for 1-4mm ADO-ADO terminals (Grey)	1SNA199341R0500	0.28
FEMAD3	End section for 1-4mm ADO-ADO terminals (Yellow)	1SNA199343R0700	0.28
FEDAD1	End section for 1-4mm ADO - 2.5 - 4mm screw clamp terminals (Grey)	1SNA199336R2000	0.24
FEDAD1	End section for 1-4mm ADO - 2.5 - 4mm screw clamp terminals (Yellow)	1SNA199339R0300	0.24
FC2	Test Plug 2mm diameter	1SNA007865R2600	1.21
BJMI6	Jumper bar - 2 pole (IP20)	1SNA176663R0000	0.52
BJMI6	Jumper bar - 3 pole (IP20)	1SNA176664R0100	0.76
BJMI6	Jumper bar - 4 pole (IP20)	1SNA176665R0200	0.96
BJMI6	Jumper bar - 5 pole (IP20)	1SNA176666R0300	1.29
BJMI6	Jumper bar - 10 pole (IP20)	1SNA176667R0400	3.34
EL6	Connector plate for linking two jumper bars together	1SNA173627R2100	0.22
CBM5	Screen Bar 0.5mm thickness	1SNA178745R1400	0.34
CBM8	Screen Bar 0.8mm thickness	1SNA178746R1500	0.43

Terminal Blocks

ADO Terminals

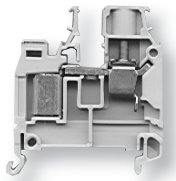
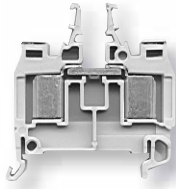

2.5mm² ADO Feed Through Terminal Blocks		Product Hierarchy 300006	
Type	Description	Order Code	Price
D2,5/8.ADO	2.5mm² ADO feed through terminal (Grey)	1SNA199059R0600	0.57
D2,5/8.ADO	2.5mm² ADO feed through terminal (Blue)	1SNA199061R2000	0.59
D2,5/8.PADO	2.5mm² ADO feed through terminal, Ground (Green / Yellow)	1SNA199091R1700	2.15
D2,5/8.ADO	2.5mm² ADO feed through terminal (Black)	1SNA199089R2500	0.57
D6/8.ADO	2.5mm² ADO - 6mm² screw clamp feed through terminal (Grey)	1SNA199042R2500	0.57
D6/8.PADO	2.5mm² ADO - 6mm² screw clamp feed through terminal, Ground (Green / Yellow)	1SNA199118R2600	2.15
D6/8.ADO	2.5mm² ADO - 6mm² screw clamp feed through terminal (Orange)	1SNA199043R2600	0.57
D6/8.ADO	2.5mm² ADO - 6mm² screw clamp feed through terminal (Black)	1SNA199077R2000	0.57
D6/8.1.ADO	2.5mm² ADO - 6mm² screw clamp feed through terminal with partition (Grey)	1SNA199046R2100	0.67
Accessories		Product Hierarchy 300008	
Type	Description	Order Code	Price
FEMAD3	End section for 1-4mm ADO-ADO terminals (Grey)	1SNA199341R0500	0.28
FEMAD3	End section for 1-4mm ADO-ADO terminals (Yellow)	1SNA199343R0700	0.28
FEDAD1	End section for 1-4mm ADO - 2.5 - 6mm screw clamp terminals (Grey)	1SNA199336R2000	0.24
FEDAD1	End section for 1-4mm ADO - 2.5 - 6mm screw clamp terminals (Yellow)	1SNA199339R0300	0.24
BJMI8	Jumper bar - 2 pole (IP20)	1SNA176669R1600	0.82
BJMI8	Jumper bar - 3 pole (IP20)	1SNA176670R1300	1.19
BJMI8	Jumper bar - 4 pole (IP20)	1SNA176671R0000	1.53
BJMI8	Jumper bar - 5 pole (IP20)	1SNA176672R0100	1.91
BJMI8	Jumper bar - 10 pole (IP20)	1SNA176673R0200	3.47
EL6	Connector plate for linking two jumper bars together	1SNA173627R2100	0.22

Terminal Blocks

ADO Terminals

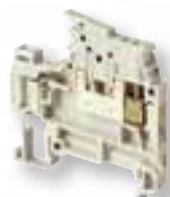
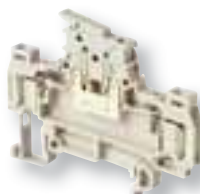
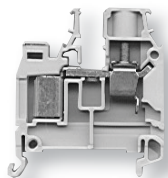

4mm² ADO Feed Through Terminal Blocks

Product Hierarchy 300006

Type	Description	Order Code	Price
D4/8.ADO	4mm² ADO feed through terminal (Grey)	1SNA399244R1400	0.58
D4/8.ADO	4mm² ADO feed through terminal (Blue)	1SNA399318R1600	0.60
D6/8.ADO3	4mm² ADO - 6mm² screw clamp feed through terminal (Grey)	1SNA399245R1500	0.58

Accessories

Product Hierarchy 300008

Type	Description	Order Code	Price
FEMAD3	End section for 1-4mm ADO-ADO terminals (Grey)	1SNA199341R0500	0.28
FEMAD3	End section for 1-4mm ADO-ADO terminals (Yellow)	1SNA199343R0700	0.28
BJMI8	Jumper bar - 2 pole (IP20)	1SNA176669R1600	0.82
BJMI8	Jumper bar - 3 pole (IP20)	1SNA176670R1300	1.19
BJMI8	Jumper bar - 4 pole (IP20)	1SNA176671R0000	1.53
BJMI8	Jumper bar - 5 pole (IP20)	1SNA176672R0100	1.91
BJMI8	Jumper bar - 10 pole (IP20)	1SNA176673R0200	3.47
EL6	Connector plate for linking two jumper bars together	1SNA173627R2100	0.22

ADO Disconnect Terminal Blocks

Product Hierarchy 300006

Type	Description	Order Code	Price
D1,5/6.SNT2.ADO	1.5mm² ADO - ADO blade disconnect terminal with 2mm test sockets (Grey)	1SNA199144R2000	1.87
D2,5/8.SNT2.ADO	2.5mm² ADO - ADO blade disconnect terminal with 2mm test sockets (Grey)	1SNA199231R2700	1.91
D4/6.SN.ADO	1.5mm² ADO - 4mm² screw clamp blade disconnect terminal (Grey)	1SNA199107R2400	1.69
D4/8.SN.ADO	2.5mm² ADO - 4mm² screw clamp blade disconnect terminal (Grey)	1SNA199137R1100	1.60

Accessories

Product Hierarchy 300008

Type	Description	Order Code	Price
FEDAD5	End section for 1.5-2.5mm ADO-ADO blade disconnect terminals (Grey)	1SNA199354R0200	0.36
FEDAD4	End section for 1.5-2.5mm ADO- 2.5mm² screw clamp blade disconnect terminals (Grey)	1SNA199352R0000	0.33
BJAD06.4	Push in jumper bar, 4 pole for 6mm pitch ADO blade disconnect terminals (Orange)	1SNA205976R0000	0.76
BJAD06.20	Push in jumper bar, 20 pole for 6mm pitch ADO terminals (Orange)	1SNA205992R2100	4.37

Terminal Blocks

ADO Terminals



ADO Fuse Terminal Blocks

Product Hierarchy 300006

Type	Description	Order Code	Price
D1,5/8.SFT.ADO	1.5mm ² ADO - ADO 5 x 20 / 5 x 25mm flip top fuse terminal (Grey)	1SNA199208R1100	2.42
D2,5/8.SFT.ADO2	2.5mm ² ADO - ADO 5 x 20 / 5 x 25mm flip top fuse terminal (Grey)	1SNA199184R1100	2.42
D4/8.SF.I.ADO	1.5mm ² ADO - 4mm ² screw clamp 5 x 20 / 5 x 25mm flip top fuse terminal (Grey)	1SNA399785R0300	2.42

Accessories

Product Hierarchy 300008

Type	Description	Order Code	Price
FEDAD7	End section for ADO - ADO fuse terminals (Grey)	1SNA199382R2700	0.37
FEDAD10	End section for ADO - screw clamp fuse terminals (Grey)	1SNA399758R2700	0.20
TGA8	Assembly rod, 2 pole, to link flip top fuse carriers M4/8.SF M4/8.SN series.	1SNA168672R1100	0.56
ANT	Assembly ring locks TGA8 in place on flip top fuse carriers M4/8.SF M4/8.SN series.	1SNA168675R1400	0.06
FU520	5 x 20mm 250V 0.5A fuse	1SNA008288R1500	0.41
FU520	5 x 20mm 250V 1A fuse	1SNA008290R1300	0.41
FU520	5 x 20mm 250V 2A fuse	1SNA008291R0000	0.41
FU520	5 x 20mm 250V 3.15A fuse	1SNA008289R1600	0.41
FU520	5 x 20mm 250V 5A fuse	1SNA008292R0100	0.41
FU525	5 x 25mm 250V 2.5A fuse	1SNA167548R0400	3.57
FU525	5 x 25mm 250V 4A fuse	1SNA167549R0500	0.36
CN5	5 x 25mm neutral bar	1SNA179371R1600	0.30

Terminal Blocks

ADO Terminals



ADO Double Deck Terminal Blocks		Product Hierarchy 300006	
Type	Description	Order Code	Price
D4/6.D2.ADO	1.5mm ² ADO - 4mm ² screw clamp double deck terminal (Grey)	1SNA199242R0200	1.58

Accessories		Product Hierarchy 300008	
Type	Description	Order Code	Price
FED2AD1	End section for ADO - Screw clamp double deck terminals (Grey)	1SNA199242R0200	0.68

BJMI6	Jumper bar - 2 pole (IP20)	1SNA176663R0000	0.52
BJMI6	Jumper bar - 3 pole (IP20)	1SNA176664R0100	0.76
BJMI6	Jumper bar - 4 pole (IP20)	1SNA176665R0200	0.96
BJMI6	Jumper bar - 5 pole (IP20)	1SNA176666R0300	1.29
BJMI6	Jumper bar - 10 pole (IP20)	1SNA176667R0400	3.34
EL6	Connector plate for linking two jumper bars together	1SNA173627R2100	0.22

BJAD06.4	Push in jumper bar, 4 pole for 6mm pitch ADO double deck terminals (Orange)	1SNA205976R0000	0.76
BJAD06.20	Push in jumper bar, 20 pole for 6mm pitch ADO double deck terminals (Orange)	1SNA205992R2100	4.37

PC6	Comb jumper bar - 2 pole for ADO double deck terminal	1SNA113546R1400	0.98
PC6	Comb jumper bar - 10 pole for ADO double deck terminal	1SNA113548R2600	1.43

General ADO Accessories - Tools		Product Hierarchy 300006	
Type	Description	Order Code	Price
OUPAD	Semi automatic ADO hand tool	1SNA178944R0400	88.37
OUMAD	ADO hand tool	1SNA179466R0600	5.06
OUTA	Replacement head for OUPAD semi automatic hand tool	1SNA205284R0300	23.77

Terminal Blocks

Marker Cards

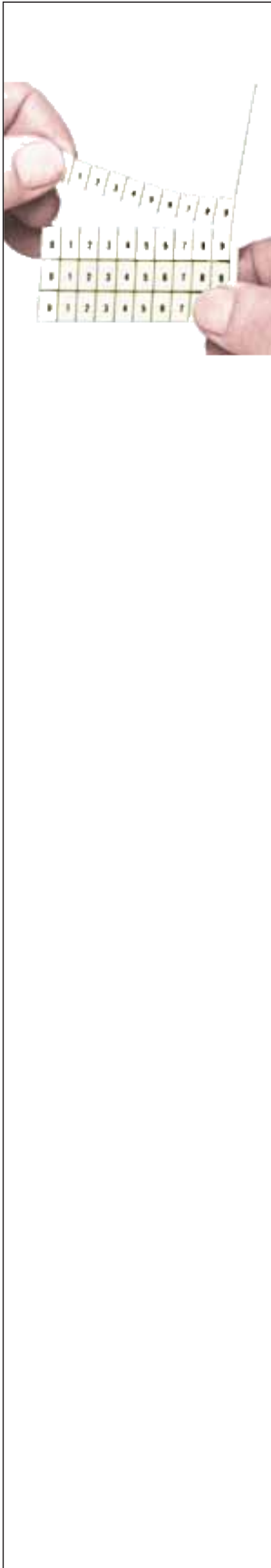

RC410 Marker Cards		Product Hierarchy 300008	
Type	Description	Order Code	Price
RC410	RC410 Marker Card - BLANK	1SNA229000R1500	1.53
RC55 Marker Cards			
RC55	RC55 Marker Card - Blank	1SNA230000R1200	1.53
RC55	RC55 Marker Card - Horizontal 10 x [0-9]	1SNA230001R0700	3.20
RC55	RC55 Marker Card - Horizontal 10 x [1-10]	1SNA230002R0000	3.20
RC55	RC55 Marker Card - Horizontal 10 x [1-100]	1SNA230030R0700	3.20
RC510 Marker Cards			
RC510	RC510 Marker Card - BLANK	1SNA231000R0700	1.53
RC510	RC510 Marker Card - Horizontal 10 x [1-10]	1SNA231002R2500	3.20
RC510	RC510 Marker Card - Horizontal 10 x [11-20]	1SNA231003R2600	3.20
RC510	RC510 Marker Card - Horizontal 10 x [21-30]	1SNA231004R2700	3.20
RC510	RC510 Marker Card - Horizontal 10 x [31-40]	1SNA231005R2000	3.20
RC510	RC510 Marker Card - Horizontal 10 x [41-50]	1SNA231006R2100	3.20
RC510	RC510 Marker Card - Horizontal 10 x [51-60]	1SNA231007R2200	3.20
RC510	RC510 Marker Card - Horizontal 10 x [61-70]	1SNA231008R0300	3.20
RC510	RC510 Marker Card - Horizontal 10 x [71-80]	1SNA231009R0400	3.20
RC510	RC510 Marker Card - Horizontal 10 x [81-90]	1SNA231010R2000	3.20
RC510	RC510 Marker Card - Horizontal 10 x [91-100]	1SNA231011R1500	3.20
RC510	RC510 Marker Card - Horizontal [1-100]	1SNA231030R2400	3.20
RC510	RC510 Marker Card - Horizontal [101-200]	1SNA231031R1100	3.20
RC510	RC510 Marker Card - Horizontal [301-400]	1SNA231033R1300	3.20
RC510	RC510 Marker Card - Horizontal [401-500]	1SNA231034R1400	3.20
RC510	RC510 Marker Card - Vertical 10 x [1-10]	1SNA231041R2300	3.20
RC510	RC510 Marker Card - Vertical 10 x [11-20]	1SNA231042R2400	3.20
RC510	RC510 Marker Card - Vertical 10 x [21-30]	1SNA231043R2500	3.20
RC510	RC510 Marker Card - Vertical [1-100]	1SNA231060R0200	3.20
RC510	RC510 Marker Card - Red Text [1-100]	1SNA231074R2400	
RC510	RC510 Marker Card - Horizontal 100 x 	1SNA231115R1200	3.20
RC65 Marker Cards			
RC65	RC65 Marker Card - BLANK	1SNA232000R0000	1.53
RC65	RC65 Marker Card - Horizontal 10 x [1-10]	1SNA232002R2600	3.20
RC65	RC65 Marker Card - Horizontal 10 x [11-20]	1SNA232003R2700	3.20
RC65	RC65 Marker Card - Horizontal 10 x [21-30]	1SNA232004R2000	3.20
RC65	RC65 Marker Card - Horizontal [1-100]	1SNA232030R2500	3.20
RC65	RC65 Marker Card - Horizontal [101-200]	1SNA232031R1200	3.20

Terminal Blocks

Marker Cards

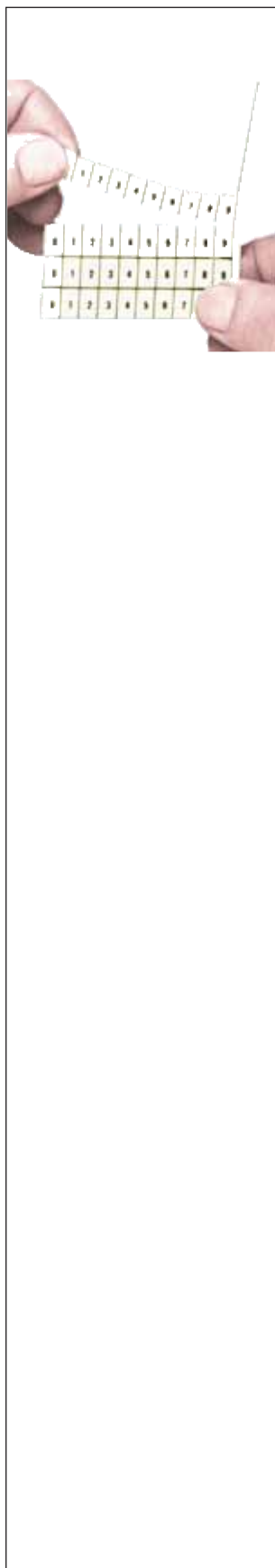

RC610 Marker Cards		Product Hierarchy 300008	
RC610	RC610 Marker Card - BLANK	1SNA233000R0100	1.53
RC610	RC610 Marker Card - Horizontal 10 x [1-10]	1SNA233002R2700	3.20
RC610	RC610 Marker Card - Horizontal 10 x [11-20]	1SNA233003R2000	3.20
RC610	RC610 Marker Card - Horizontal 10 x [21-30]	1SNA233004R2100	3.20
RC610	RC610 Marker Card - Horizontal 10 x [31-40]	1SNA233005R2200	3.20
RC610	RC610 Marker Card - Horizontal 10 x [41-50]	1SNA233006R2300	3.20
RC610	RC610 Marker Card - Horizontal 10 x [51-60]	1SNA233007R2400	3.20
RC610	RC610 Marker Card - Horizontal 10 x [61-70]	1SNA233008R0500	3.20
RC610	RC610 Marker Card - Horizontal 10 x [71-80]	1SNA233009R0600	3.20
RC610	RC610 Marker Card - Horizontal 10 x [81-90]	1SNA233010R2200	3.20
RC610	RC610 Marker Card - Horizontal 10 x [91-100]	1SNA233011R1700	3.20
RC610	RC610 Marker Card - Horizontal 10 x [101-110]	1SNA233012R1000	3.20
RC610	RC610 Marker Card - Horizontal 10 x [111-120]	1SNA233013R1100	3.20
RC610	RC610 Marker Card - Horizontal 10 x [121-130]	1SNA233014R1200	3.20
RC610	RC610 Marker Card - Horizontal 10 x [131-140]	1SNA233015R1300	3.20
RC610	RC610 Marker Card - Horizontal 10 x [141-150]	1SNA233016R1400	3.20
RC610	RC610 Marker Card - Horizontal 10 x [151-160]	1SNA233017R1500	3.20
RC610	RC610 Marker Card - Horizontal 10 x [161-170]	1SNA233018R2600	3.20
RC610	RC610 Marker Card - Horizontal [1-100]	1SNA233030R2600	3.20
RC610	RC610 Marker Card - Horizontal [101-200]	1SNA233031R1300	3.20
RC610	RC610 Marker Card - Horizontal [201-300]	1SNA233032R1400	3.20
RC610	RC610 Marker Card - Horizontal [301-400]	1SNA233033R1500	3.20
RC610	RC610 Marker Card - Horizontal [401-500]	1SNA233034R1600	3.20
RC610	RC610 Marker Card - Horizontal [501-600]	1SNA233035R1700	3.20
RC610	RC610 Marker Card - Vertical 10 x [1-10]	1SNA233041R2500	3.20
RC610	RC610 Marker Card - Vertical 10 x [11-20]	1SNA233042R2600	3.20
RC610	RC610 Marker Card - Vertical 10 x [21-30]	1SNA233043R2700	3.20
RC610	RC610 Marker Card - Vertical 10 x [41-50]	1SNA233045R2100	3.20
RC610	RC610 Marker Card - Vertical 10 x [61-70]	1SNA233047R2300	3.20
RC610	RC610 Marker Card - Vertical [1-100]	1SNA233060R0400	3.20
RC610	RC610 Marker Card - Vertical [101-200]	1SNA233061R2100	3.20
RC610	RC610 Marker Card - Vertical [201-300]	1SNA233062R2200	3.20
RC610	RC610 Marker Card - Horizontal 20 x [L1 L2 L3 N PE]	1SNA233131R1400	3.20
RC610	RC610 Marker Card - Horizontal 2 x [1-50]	1SNA233141R2600	3.20

Terminal Blocks

Marker Cards

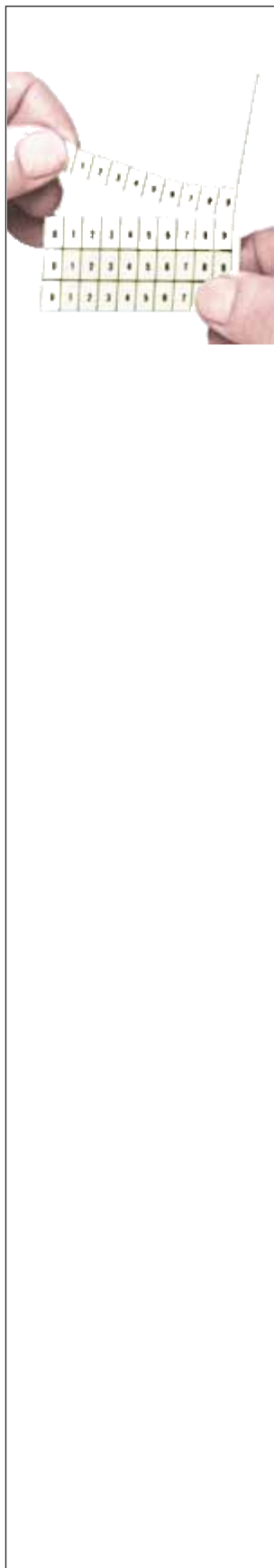

RC810 Marker Cards		Product Hierarchy 300008	
RC810	RC810 Marker Card - BLANK	1SNA234000R0200	2.02
RC810	RC810 Marker Card - Horizontal 10 x [1-10]	1SNA234002R2000	3.40
RC810	RC810 Marker Card - Horizontal 10 x [11-20]	1SNA234003R2100	3.40
RC810	RC810 Marker Card - Horizontal 10 x [21-30]	1SNA234004R2200	3.40
RC810	RC810 Marker Card - Horizontal 10 x [31-40]	1SNA234005R2300	3.40
RC810	RC810 Marker Card - Horizontal 10 x [41-50]	1SNA234006R2400	3.40
RC810	RC810 Marker Card - Horizontal [1-100]	1SNA234030R2700	3.40
RC810	RC810 Marker Card - Vertical 10 x [1-10]	1SNA234041R2600	3.40
RC810	RC810 Marker Card - Vertical 10 x [11-20]	1SNA234042R2700	3.40
RC810	RC810 Marker Card - Vertical [1-100]	1SNA234060R0500	3.40

Marker Cards - General

---	Permenant Marker Pen	1SNA164386R2700	4.90
REH3	Marker Card Red Text 22 x [1-30] & 1 x [1-20]	1SNA164695R2500	7.81
RTM7	0.5m Strip of blank markers for Top of 6mm pitch terminals	1SNA168410R0700	0.83
RCPEB	Sheet of 54 Markers	1SNA178430R0500	7.86
EPR1	Sheet of 54 Clear Covers for RCPEB Markers	1SNA178431R2200	7.86
RCCV	RCCV Card of 48 blank wire markers	1SNA235460R0400	0.98
PETC53	Clear Holder For RCCV Markers	1SNA168741R1600	0.02
RCT610	RCT 610 Top Marker Card - BLANK	1SNA236000R0400	0.93
RCT810	RCT 810 Top Marker Card - BLANK	1SNA236500R0600	1.50
RC1010	RC1010 Marker Card - BLANK	1SNA238000R1600	2.25

AMS500 Plotter Accessories

AMS PEN 0,25	0.25mm Pen for AMS500 Plotter	1SNA360100R2500	83.17
AMS PEN 0,35	0.35mm Pen for AMS500 Plotter	1SNA360101R1200	83.17
---	0.35mm Disposable Pen for AMS500 Plotter	1SNA360121R0500	47.92
AMS INK	Pack of 5 ink cartridges for AMS500 Plotter	1SNA360150R2600	9.03
AMS CLEANER	Pen Cleaner for AMS500 pens	1SNA360155R1700	12.48

Terms and Conditions

1. GENERAL

- 1.1. Whenever ABB Limited ("ABB") has referred to Orgalime S 2000 in a quotation or other type of offer or in an order acknowledgement, Orgalime S 2000 and this Addendum shall apply to the resulting contract between ABB and the Purchaser. If the Purchaser refers to other terms and conditions in the Purchaser's previous or subsequent communications with ABB, such other terms and conditions shall apply only to the extent ABB expressly agrees thereto in writing.
- 1.2. The Purchaser represents that it has access to the Orgalime S 2000 terms and conditions.
- 1.3. Should ABB accept other terms and conditions than the ones contained in Orgalime S 2000 and this Addendum, ABB shall not be bound by the price, delivery terms, warranties and other terms quoted by ABB, unless the ABB quotation expressly refers to those other terms and conditions.
- 1.4. In the event of any contradictions or discrepancies between this Addendum and Orgalime S 2000, this Addendum shall prevail.

2. DEFINITIONS

In Orgalime S 2000 and this Addendum,

- (a) "Orgalime S 2000" shall mean Orgalime's General Conditions for the Supply of Mechanical, Electrical and Electronic Products, August 2000 edition or the latest edition published thereafter;
- (b) "Product" shall include services to be provided by ABB in relation to the Product;
- (c) "Purchaser" shall mean the other party to the contract; and
- (d) "Supplier" shall mean ABB.

3. AMENDMENTS

3.1. Standard Products

- 3.1.1. The Product shall be supplied in its standard version together with ABB's relevant standard documentation and instruction manuals as appropriate. Alternative finishes, colours and special packing may be supplied at extra charge, as may additional documentation.
- 3.1.2. The Product is not warranted to be fit for any particular purpose, unless and to the extent such particular purpose has been expressly specified and warranted by ABB in writing.

3.2. Payment Terms

- 3.2.1. Payment shall be made by the Purchaser no later than thirty (30) days from the date the relevant invoice was issued, unless otherwise stated on the invoice. Should part of an invoice be disputed by the Purchaser, the Purchaser shall nevertheless pay the undisputed amount on the due payment date. Payment may be made via BACS.
- 3.2.2. Payment shall be made in the currency in which the purchase price was quoted by ABB.

3.2.3. Should

- (a) the Purchaser's payments be overdue by more than 14 calendar days;
- (b) proceedings be commenced to wind up the Purchaser (except for the purpose of solvent amalgamation or reconstruction);
- (c) any composition or arrangement with the Purchaser's creditors be made; or
- (d) the Purchaser be put under administration, or if a receiver is appointed,

ABB shall be entitled (without incurring any liability therefor) to terminate the contract by notice in writing, and thereupon to recover any loss or damage ABB has suffered as a result of such termination, except that the compensation paid towards such loss or damage shall not exceed the purchase price.

3.3. VAT

The purchase price is strictly net and exclusive of VAT and similar.

3.4. Retention of Title

- 3.4.1. The Product shall remain the property of the Supplier until paid for in full.
- 3.4.2. Until title in the Product has passed to the Purchaser, the Purchaser shall keep the Product and any part thereof in the Purchaser's possession clearly marked or otherwise identified as being ABB's, and store them separately from the Purchaser's own plant. ABB shall be entitled at any time during normal business hours to enter the Purchaser's premises in order to inspect the Product and ensure that it is so marked or clearly identified.
- 3.4.3. Should the contract be terminated by ABB for any reason before title in the Product has passed to the Purchaser, ABB shall be entitled at any time during normal business hours to enter the Purchaser's premises in order to recover the Product. ABB reserves the right to dispose of any Product so recovered.

3.5. Export restrictions and non-authorised use

- 3.5.1. Any supply of technology under the contract shall be subject to any laws and other restrictions on the export, re-export or import of any technology licensed under the contract as may be imposed from time to time by the UK or United States Governments or their agencies. The Purchaser shall not knowingly export, re-export or import, directly or indirectly, any such technology licensed from or provided by ABB to any country for which the UK or United States Governments or any their agencies require an export licence or other Government approval at the time of such export, without first obtaining such licence or approval. The Purchaser shall require that all third parties receiving such technology from the Purchaser comply with this requirement.
ABB shall assist the Purchaser in every reasonable way in the investigation and clarification of any possible export or import licence requirements and in the obtaining of such licences at the Purchaser's cost.
- 3.5.2. The performance by either of the parties of an obligation under the contract, which performance requires an export or import licence or other government approval, and any other obligation affected shall, to the extent it is necessary, automatically be suspended until such licence or approval as mentioned in sub clause 3.5.1 is given. If such licence is not granted within a reasonable time or is revoked by the appropriate authorities, ABB shall be entitled to terminate the contract, and the Purchaser shall compensate ABB for any loss or damage as a result of such termination.

Terms and Conditions

- 3.5.3. Unless expressly agreed in writing by ABB, the Product is provided on strict condition that:
- a) the Product is solely for civil use;
 - (b) the Product is not to be supplied to any country whether directly or indirectly or for any application where such supply or application is prohibited by any law or regulation binding or effective in that country, in the United Kingdom or the country of manufacture; and
 - (c) the Product will not in any way be installed, used or applied in or in connection with the operation of any nuclear facilities such as but not limited to nuclear power plants, nuclear fuel manufacturing plants, uranium enrichment plants, spent nuclear fuel stores or research reactors.
- 3.5.4. Whenever ABB so requests, the Purchaser shall provide ABB with an end user certificate, which shall be subject to ABB's reasonable approval and signed by the Purchaser's authorised representative, confirming that the end user shall comply with subclause 3.5.3, items (a) - (c). Until such time as ABB has received such end user certificate, ABB shall be entitled to suspend the performance under the contract.
- 3.5.5. The end user certificate referred to in subclause 3.5.4 shall form part of the contract and any breach by the Purchaser or any for whom the Purchaser is liable (which shall, without limitation, include the end-user) of any of the provisions set out in subclause 3.5.3, items (a) - (c), shall be deemed a fundamental breach of contract by the Purchaser, and shall entitle ABB to terminate the contract forthwith by giving notice to the Purchaser.
- 3.5.6. In the event of such termination as is mentioned in subclause 3.5.5, the Purchaser shall compensate (without limitation) ABB for any damage and losses sustained as a result of the breach.
- 3.5.7. The Purchaser shall keep ABB, its officers, directors, employees, agents and advisers indemnified against any claims and liabilities arising out of any breach by the Purchaser or any for whom the Purchaser is liable (which shall, without limitation, include the end user) of any of the provisions set out in this sub-clause 3.5.
- 3.6. Limitation of liability
- 3.6.1. To the maximum extent permitted by applicable law, and notwithstanding anything to the contrary in the contract or otherwise, neither party shall be liable to the other for any indirect, special, incidental or consequential damages such as, but not limited to, loss of revenue, loss of business, loss of use, interruption of business, loss of operation time, costs of capital and cost in connection with interruption of operation.
- 3.6.2. To the maximum extent permitted by applicable law, ABB limits its aggregate liability under the contract for direct damage to an amount equivalent to the price.
- 3.6.3. The Purchaser acknowledges that the contents of sub clauses 3.6.1 and 3.6.2 have especially been brought to the Purchaser's attention, and that said subclauses have been duly negotiated between the parties.
- 3.7. Indemnification
- If Products are to be manufactured or any process is to be applied to Products by ABB in accordance with a specification submitted by the Purchaser, the Purchaser shall indemnify ABB against all losses, damages, costs, expenses and claims suffered or incurred by ABB in connection with infringement of any intellectual property rights of any third party resulting from ABB's use of the Purchaser's specification.
- 3.8. Limitation period
- Subject to law as regards personal injury and death, the Purchaser shall have no claim against ABB, in contract or in tort, in relation to anything performed or delivered under the Contract (including claims for defective Products, services or goods), unless ABB has been notified in writing of such claim within twenty four (24) months of delivery.
- 3.9. Exclusion of third party rights
- Pursuant to section 1(2)(a) of the contracts (Right of Third Parties) Act 1999 (the "Act"), the parties intend that no terms of the contract may be enforced by a Third Party (as the term "Third Party" is defined in the Act).
- 3.10. Governing law
- The contract shall in all respects be governed by and construed in accordance with English substantive law. The parties agree that the United Nations Convention on contracts for the International Sale of Goods shall not apply to the contract (even if the United Kingdom or any part thereof should accede to the said convention).
- 3.11. Miscellaneous
- The contract constitutes the complete and full understanding between the parties thereto with respect to the subject matter of the contract and supersedes all previous negotiations, representations, agreements, commitments and writing in respect thereof. Neither party shall be bound by any terms conditions, definitions, warranties, understandings or representations with respect to such subject matter other than as expressly provided in the contract or as duly set forth on or subsequent to the effective date thereof in writing.
- 3.12. Min Order
- £200.00 nett carriage paid, orders below £200.00 incur £50.00 surcharge.

Contact us

ABB Limited

Tower Court
Foleshill Enterprise Park
Courtaulds Way
Coventry CV6 5NX

Phone: 02476 368500
Fax: 02476 364499

www.abb.co.uk/lowvoltage

