

Datasheet

Stock No: 286-3409

RS Pro Round Tube 3-Way Connector, strut profile Type 2



Product Details

3 Way 90° Elbow

Used as an end joint between two top rails, joining at 90°, and the upright

Dimensions (mm)	
Tube Size Ref.	B
1	48
2	60
3	67

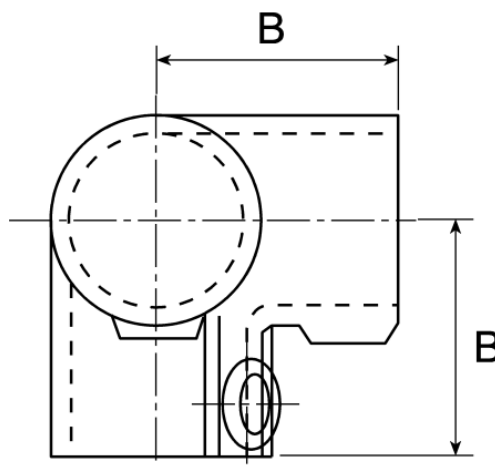



ENGLISH

Specifications:

Structural Element Type	Round Tube
Connector Type	3-Way Connector
Fits Strut Profile	Type 2
Fits Tube Diameter	42.4mm
Product Family	RS Handrail System
Material	Cast Iron
Product System	128