

S Couplers

Series *KK/KKH/KK13*

Series *KK*

- With sleeve lock (Except for KK2)
- Effective area **3.8 to 82 mm²**



Series *KKH*

- Without sleeve lock
- Effective area is equivalent to that of Series KK.



The pulling strength for the plugs and sockets has been improved.
Twice as strong as the conventional models.

Series *KK13*

Manufactured by RECTUS AG



K

M

H

KK

D

MS

LQ

MQR

T

Variations

Series KK 165 to 173

Male thread type

Series	Port size					
	M5	R1/8	R1/4	R3/8	R1/2	R3/4
KK2	●	●				
KK3		●	●	●		
KK4		●	●		●	
KK6				●	●	●

Female thread type

Series	Port size				
	M5	Rc1/8	Rc1/4	Rc3/8	Rc1/2
KK2	●				
KK3		●	●	●	
KK4			●	●	
KK6				●	●

Nut fitting type (for fiber reinforced urethane hose)

Series	Applicable hose I.D./O.D. mm					
	5/8	6/9	6.5/10	8/12	8.5/12.5	11/16
KK3	●	●	●			
KK4	●	●		●	●	
KK6				●	●	●

One-touch fitting type (Straight/Elbow/Bulkhead)

Series	Applicable tubing O.D. mm						
	ø3.2	ø4	ø6	ø8	ø10	ø12	ø16
KK2	●						
KK3		●	●	●	●		
KK4			●	●	●	●	
KK6						●	●



Series KK3/4/6



Series KK2

Series KKH 174 to 176

Male thread type

Series	Port size			
	R1/8	R1/4	R3/8	R1/2
KKH3	●	●	●	
KKH4	●	●	●	●

Female thread type

Series	Port size		
	Rc1/8	Rc1/4	Rc3/8
KKH3	●		
KKH4	●	●	●

Nut fitting type (for fiber reinforced urethane hose)

Series	Applicable hose I.D./O.D. mm				
	5/8	6/9	6.5/10	8/12	8.5/12.5
KKH3	●	●	●		
KKH4	●	●	●	●	●



Series KK13 177 to 181

Manufactured by RECTUS AG

Male thread type

Series	Port size			
	R1/8	R1/4	R3/8	R1/2
KK13	●	●	●	●

Female thread type

Series	Port size			
	Rc1/4	Rc3/8	Rc1/2	G1/4
KK13	●	●	●	●

Barb fitting type

Series	Applicable hose I.D.			
	1/4"	1/4"	3/8"	1/2"
KK13	●	●	●	●

Plug nut fitting type (for fiber reinforced urethane hose)

Series	Applicable hose I.D./O.D. mm					
	5/8	6/9	6.5/10	8/12	8.5/12.5	11/16
KK13	●	●	●	●	●	●



Series KKA 267 to 275

Stainless steel type

Male/Female thread type

Series	Port size								
	R-Rc1/8	R-Rc1/4	R-Rc3/8	R-Rc1/2	R-Rc3/4	R-Rc1	R-Rc1 1/4	R-Rc1 1/2	
KKA3	●	●	●						
KKA4		●	●	●					
KKA6			●	●		●			
KKA7				●		●	●		
KKA8						●	●	●	
KKA9						●	●	●	●



S Couplers

Series KK



The pulling strength for the plugs and sockets has been improved.

Twice

as strong as the conventional models

We standardized the product with a sleeve cover. Changing the lock ring material to a shock absorbent PBT further improved the shock absorbent performance.

Employs a unique connection method

A slim body design and large effective area are achieved with a construction that does not use steel balls and therefore does not restrict the flow path.

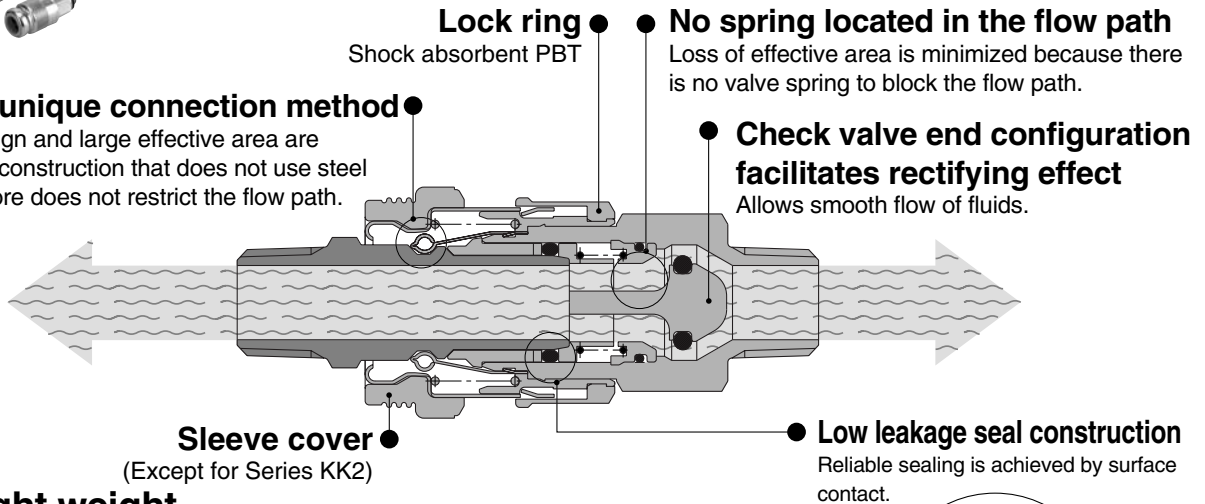

Light weight

Together with a reduction of the body size, pressing parts and resin parts are used to achieve an overall weight reduction.

Series	Plug no.	Socket no.	Effective area (mm ²) ^{Note 1)}	Body O.D. (mm)	Mass (g) ^{Note 2)}
Series KK2	KK2P-M5M	KK2S-M5M	3.8	ø10.0	6.1
Series KK3	KK3P-01MS	KK3S-01MS	20	ø20.2	20.1
Series KK4	KK4P-02MS	KK4S-02MS	39	ø28.0	44.1
Series KK6	KK6P-04MS	KK6S-04MS	82	ø31.6	90.1

Note 1) Values when plug and socket are connected.

Note 2) Values for socket only.

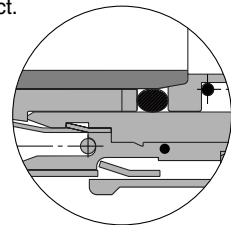

One-touch fitting type standardized

Four types from ø3.2 to ø16 added to series.



Flow is possible from the plug side or socket side.

Fluids: Air and Water

One-touch connection

Simple connection with one hand simplifies work.

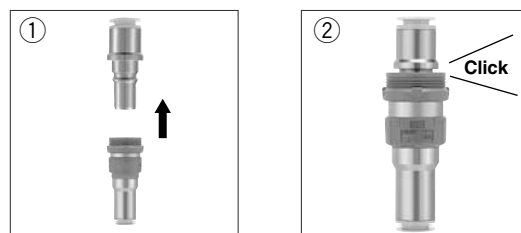

Sleeve lock mechanism

Prevents accidents caused by unexpected separation.

Note) Except for M5 type (Series KK2).

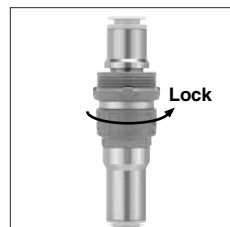

- K
- M
- H
- KK**
- D
- MS
- LQ
- MQR
- T

Series KK

Plug (P)

Male thread type



Body size	Port size	Part no.
M5	M5 x 0.8	KK2P-M5M
	R 1/8	-01MS
1/8	R 1/8	KK3P-01MS
	R 1/4	-02MS
	R 3/8	-03MS
1/4	R 1/8	KK4P-01MS
	R 1/4	-02MS
	R 3/8	-03MS
	R 1/2	-04MS
1/2	R 3/8	KK6P-03MS
	R 1/2	-04MS
	R 3/4	-06MS

Female thread type



Body size	Port size	Part no.
M5	M5 x 0.8	KK2P-M5F
1/8	Rc 1/8	KK3P-01F
	Rc 1/4	-02F
	Rc 3/8	-03F
1/4	Rc 1/4	KK4P-02F
	Rc 3/8	-03F
1/2	Rc 3/8	KK6P-03F
	Rc 1/2	-04F

Nut fitting type (for fiber reinforced urethane hose)



Body size	Applicable hose I.D./O.D. mm	Part no.
1/8	5/8	KK3P-50N
	6/9	-60N
	6.5/10	-65N
1/4	5/8	KK4P-50N
	6/9	-60N
	6.5/10	-65N
	8/12	-80N
	8.5/12.5	-85N
1/2	8/12	KK6P-80N
	8.5/12.5	-85N
	11/16	-110N

Straight type with One-touch fitting



Body size	Applicable tubing O.D. mm	Part no.
M5	3.2	KK2P-23H
	4	-04H
	6	-06H
1/8	4	KK3P-04H
	6	-06H
	8	-08H
	10	-10H
	6	KK4P-06H
1/4	8	-08H
	10	-10H
	12	-12H
1/2	12	KK6P-12H
	16	-16H

Elbow type with One-touch fitting



Body size	Applicable tubing O.D. mm	Part no.
M5	3.2	KK2P-23L
	4	-04L
	6	-06L
1/8	4	KK3P-04L
	6	-06L
	8	-08L
	10	-10L
1/4	6	KK4P-06L
	8	-08L
	10	-10L
1/2	12	KK6P-12L
	12	-12L
	16	-16L

Bulkhead type with One-touch fitting



Body size	Applicable tubing O.D. mm	Part no.
M5	3.2	KK2P-23E
	4	-04E
	6	-06E
1/8	4	KK3P-04E
	6	-06E
	8	-08E
	10	-10E
	6	KK4P-06E
1/4	8	-08E
	10	-10E
	12	-12E
1/2	12	KK6P-12E
	16	-16E

Socket (S)

Male thread type



Body size	Port size	Part no.
M5	M5 x 0.8	KK2S-M5M
	R 1/8	-01MS
1/8	R 1/8	KK3S-01MS
	R 1/4	-02MS
	R 3/8	-03MS
1/4	R 1/8	KK4S-01MS
	R 1/4	-02MS
	R 3/8	-03MS
	R 1/2	-04MS
1/2	R 3/8	KK6S-03MS
	R 1/2	-04MS
	R 3/4	-06MS

Female thread type



Body size	Port size	Part no.
M5	M5 x 0.8	KK2S-M5F
1/8	Rc 1/8	KK3S-01F
	Rc 1/4	-02F
	Rc 3/8	-03F
1/4	Rc 1/4	KK4S-02F
	Rc 3/8	-03F
1/2	Rc 3/8	KK6S-03F
	Rc 1/2	-04F

Nut fitting type (for fiber reinforced urethane hose)



Body size	Applicable hose I.D./O.D. mm	Part no.
1/8	5/8	KK3S-50N
	6/9	-60N
	6.5/10	-65N
1/4	5/8	KK4S-50N
	6/9	-60N
	6.5/10	-65N
	8/12	-80N
	8.5/12.5	-85N
1/2	8/12	KK6S-80N
	8.5/12.5	-85N
	11/16	-110N

Straight type with One-touch fitting



Body size	Applicable tubing O.D. mm	Part no.
M5	3.2	KK2S-23H
	4	-04H
	6	-06H
1/8	4	KK3S-04H
	6	-06H
	8	-08H
	10	-10H
	6	KK4S-06H
1/4	8	-08H
	10	-10H
	12	-12H
1/2	12	KK6S-12H
	16	-16H

Elbow type with One-touch fitting



Body size	Applicable tubing O.D. mm	Part no.
M5	3.2	KK2S-23L
	4	-04L
	6	-06L
1/8	4	KK3S-04L
	6	-06L
	8	-08L
	10	-10L
1/4	6	KK4S-06L
	8	-08L
	10	-10L
1/2	12	KK6S-12L
	12	-12L
	16	-16L

Bulkhead type with One-touch fitting



Body size	Applicable tubing O.D. mm	Part no.
M5	3.2	KK2S-23E
	4	-04E
	6	-06E
1/8	4	KK3S-04E
	6	-06E
	8	-08E
	10	-10E
	6	KK4S-06E
1/4	8	-08E
	10	-10E
	12	-12E
1/2	12	KK6S-12E
	16	-16E

S Couplers

Series *KK*



Series KK2

Series KK3/4/6

JIS Symbol

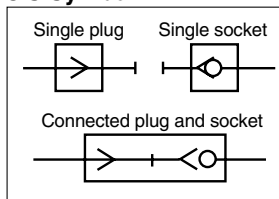

Specifications

Fluid	Air, Water
Operating pressure range <small>Note)</small>	KK2: -100 kPa to 1 MPa KK3: -90 kPa to 1 MPa KK4/6: 0 to 1 MPa
Proof pressure	1.5 MPa
Ambient and fluid temperature	Air: -5 to 60°C Water: 5 to 40°C (No freezing)
Plating, Sealant	Electroless nickel plated (copper-free and fluorine-free application), With male thread sealant

Note) Do not use the S couplers with a leak tester or for vacuum retention because they are not guaranteed for zero leakage.

Performance

Plug and socket connection	One-touch connection and release
Check valve	Socket: Built-in check valve (standard)
Sleeve lock mechanism <small>Note)</small>	Manual locking type (standard)

Note) Series KK2 is not provided with lock mechanism.

Effective Area

Body size	Plug	Socket	Effective area mm ²
M5	KK2P-M5M	KK2S-M5M	3.8
1/8	KK3P-01MS	KK3S-01MS	20
1/4	KK4P-02MS	KK4S-02MS	39
1/2	KK6P-04MS	KK6S-04MS	82

How to Order

KK 4 S - 02 M S

- Body size**

2	M5
3	1/8
4	1/4
6	1/2
- Socket/Plug designation**

S	Socket
P	Plug
- With sealant (male thread)**
- Connection type**

Symbol	Type
M	Male thread
F	Female thread
N	With nut fitting
H	Straight with One-touch fitting
L	Elbow with One-touch fitting
E	Bulkhead with One-touch fitting
- Piping port size variation**

Male/Female thread type		One-touch fitting type		Nut fitting type	
Symbol	Thread size	Symbol	Applicable tubing O.D. mm	Symbol	Applicable hose I.D./O.D. mm
M5	M5 x 0.8	23	ø3.2	50	5/8
01	R, Rc 1/8	04	ø4	60	6/9
02	R, Rc 1/4	06	ø6	65	6.5/10
03	R, Rc 3/8	08	ø8	80	8/12
04	R, Rc 1/2	10	ø10	85	8.5/12.5
06	R, Rc 3/4	12	ø12	110	11/16
		16	ø16		

Series KK

Flow Characteristics

Air (0 to 1 MPa)

KK2

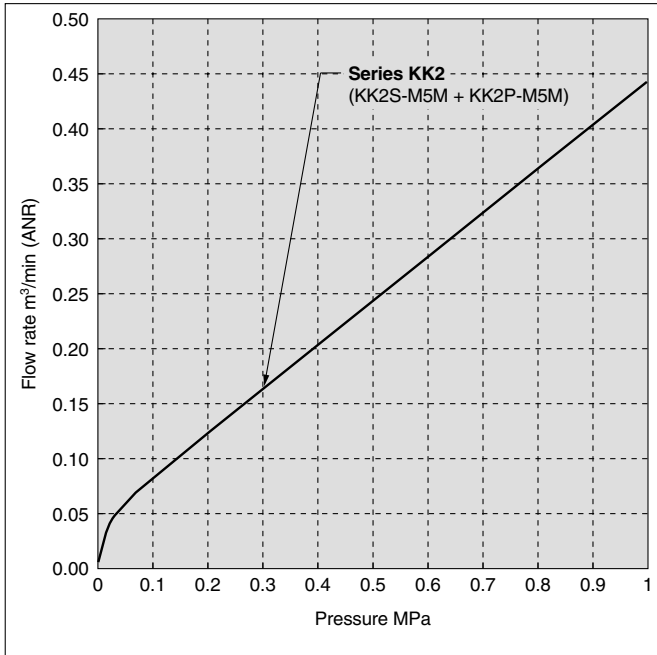

Water (0 to 0.4 MPa)

KK2

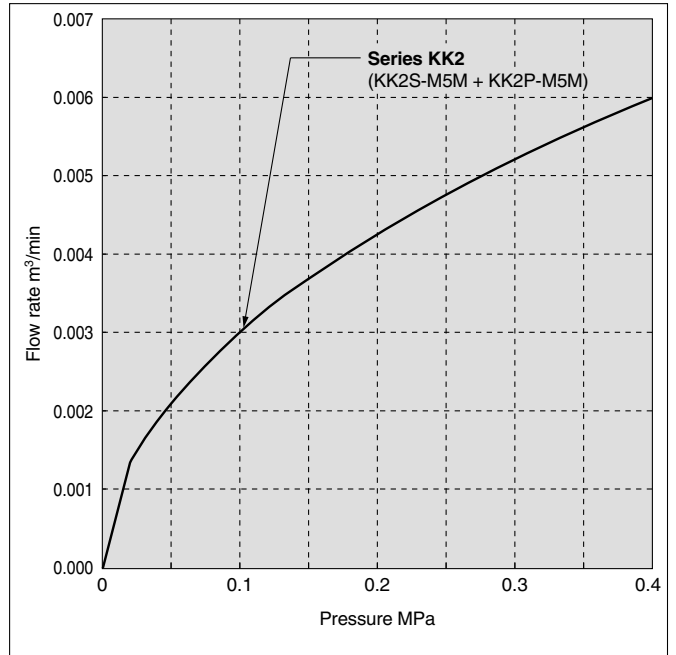

KK3/4/6

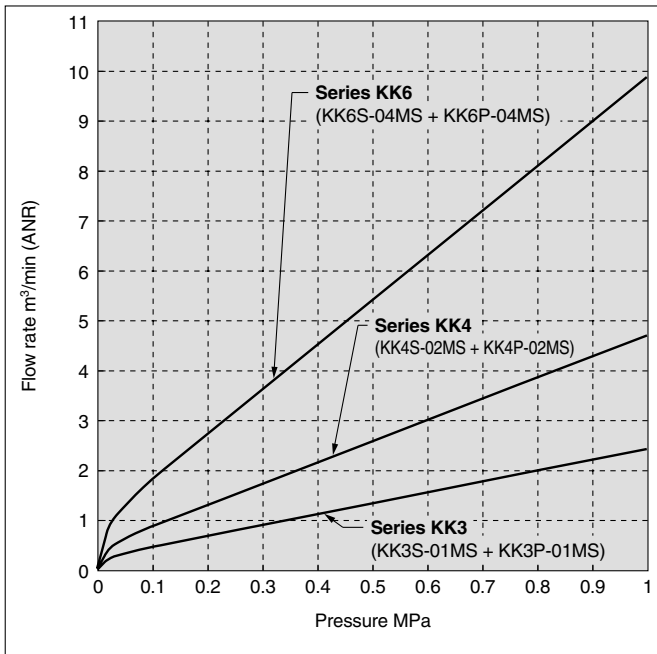

KK3/4/6

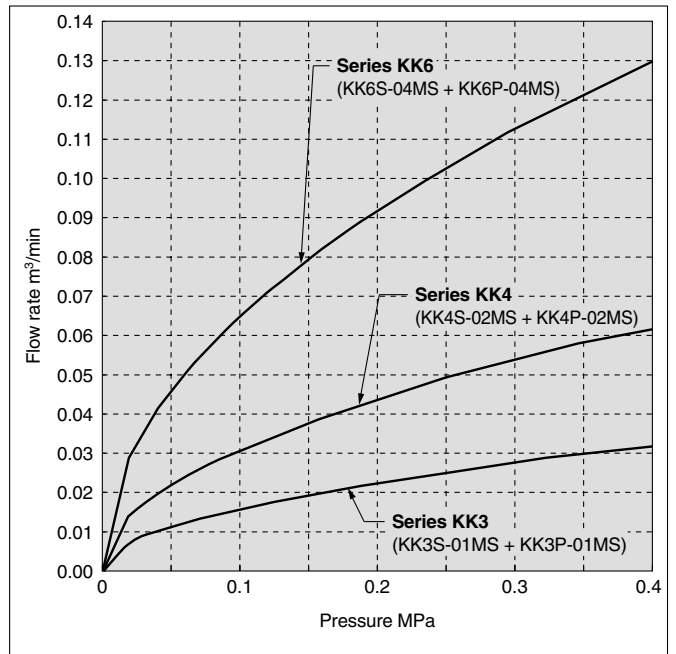

Construction

KK2

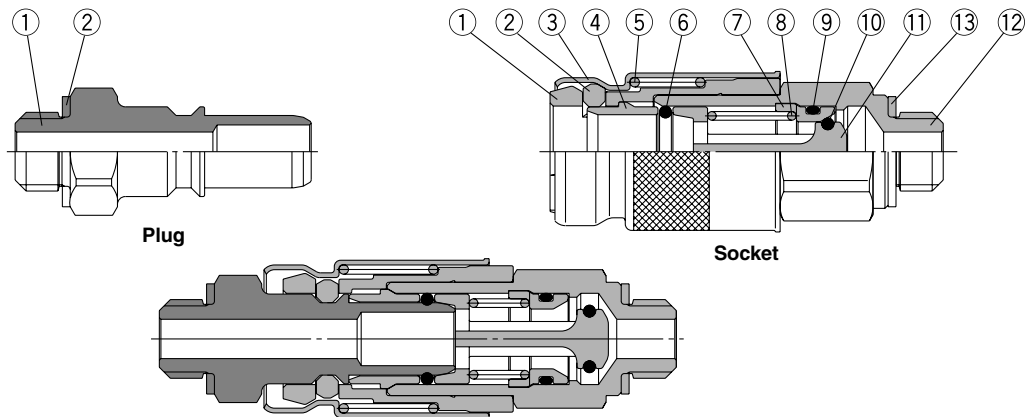

Plug

No.	Description	Material	Note
1	Stem	C3604	Electroless nickel plated
2	Gasket	Stainless steel 304, NBR	

Series KK2 Spare Parts

Description	Part no.	No.
Gasket	M-5G2	Plug ^②
		Socket ^⑬

Socket

No.	Description	Material	Note
1	Spacer	PBT	
2	Chuck	PBT	
3	Sleeve	C2680	Electroless nickel plated
4	Collar	C3604	Electroless nickel plated
5	Sleeve spring	Stainless steel 304	
6	Plug O-ring	NBR	
7	Valve seat	PBT	
8	Valve spring	Stainless steel 304	
9	Valve seat O-ring	NBR	
10	Valve O-ring	FKM	
11	Valve	PBT	
12	Socket body	C3604	Electroless nickel plated
13	Gasket	Stainless steel 304, NBR	

KK3/4/6

<With One-touch fitting >

<With One-touch fitting >

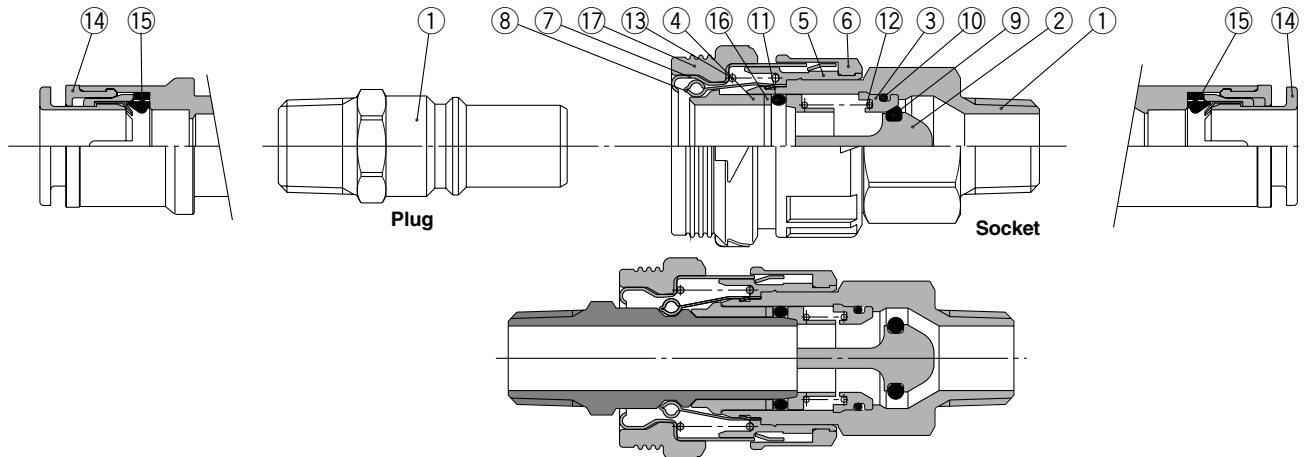

Plug

No.	Description	Material	Note
1	Stem	C3604	Electroless nickel plated
14	Cassette	—	
15	Seal	NBR	

Series KK/KKH Spare Parts

Description	Part no.	No.
Sleeve cover	KK3S-P01	Socket ^⑰
	KK4S-P01	
	KK6S-P01	

Socket

No.	Description	Material	Note
1	Body	C3604	Electroless nickel plated
2	Valve	PBT	
3	Valve seat	PBT	
4	Collar	PBT	
5	Spacer	PBT	
6	Lock ring	Shock absorbent PBT	
7	Sleeve	Cold rolled carbon steel sheet	Electroless nickel plated
8	Chuck	Stainless steel 304	
9	Valve O-ring	FKM	
10	Valve seat O-ring	NBR	
11	Plug O-ring	NBR	
12	Valve spring	Stainless steel 304	
13	Sleeve spring	Stainless steel 304	
14	Cassette	—	
15	Seal	NBR	
16	Collar 2	Stainless steel 304	
17	Sleeve cover	Weather resistant NBR	

Series KK

Dimensions/Plug (P)

Male thread type

(mm)

KK2



KK3/4/6



Body size	Model	T Connection port size	H Width across flats	L1	L2	A*	Min. bore size	Effective area mm ²	Mass g
M5	KK2P-M5M	M5 x 0.8	7	18.8	12.3	15.8	2.5	4.4	2.6
	-01MS	R 1/8	10	22.3		19.2	3.4	8.1	3.0
1/8	KK3P-01MS	R 1/8	14	29.5	18.4	26.4	6.0	22.6	8.4
	-02MS	R 1/4		32.9		27.4			14.2
	-03MS	R 3/8		35.8		30.4			28.1
1/4	KK4P-01MS	R 1/8	14	36.1	25.2	33.0	9.0	50.9	17.0
	-02MS	R 1/4		39.7		34.2			20.2
	-03MS	R 3/8		41.1		35.7			32.5
	-04MS	R 1/2		45.3		38.2			57.4
1/2	KK6P-03MS	R 3/8	19	46.9	31.0	41.5	11.0	76.0	44.7
	-04MS	R 1/2	22	51.1		44.0	13.0	106.2	53.7
	-06MS	R 3/4	27	55		45.5			94.4

* Reference dimension for R threads after installation.

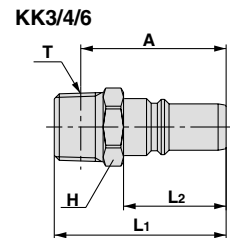
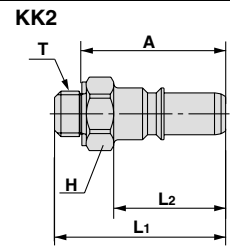

Female thread type

(mm)



Body size	Model	T Connection port size	H Width across flats	L1	L2	Min. bore size	Effective area mm ²	Mass g
M5	KK2P-M5F	M5 x 0.8	8	17.6	12.3	3.4	8.1	2.6
1/8	KK3P-01F	Rc 1/8	14	28.3	18.4	6.0	22.6	10.4
	-02F	Rc 1/4	17	35.0	19.9			20.8
	-03F	Rc 3/8	19	36.8	23.2			
1/4	KK4P-02F	Rc 1/4	17	37.2	25.2	9.0	50.9	23.9
	-03F	Rc 3/8	19	39.8				24.6
1/2	KK6P-03F		Rc 1/2	19	43.3	31.0	13.0	106.2
	-04F	24		50.2	43.9			

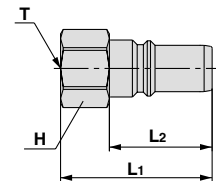

Nut fitting type (for fiber reinforced urethane hose)

(mm)



Body size	Model	Applicable hose I.D./O.D.	H1 Width across flats	H2 Width across flats	L1	L2	M	Min. bore size	Effective area mm ²	Mass g	
1/8	KK3P-50N	5/8	14	14	36.1	18.4	13.7	4.5	12.7	21.4	
	-60N	6/9		17			39.9	16.5	5.4	18.3	38.8
	-65N	6.5/10		17			39.9	16.5	5.9	21.9	35.9
1/4	KK4P-50N	5/8	17	14	43.9	25.2	13.7	4.5	12.7	34.7	
	-60N	6/9		17			46.7	16.5	5.4	18.3	48.4
	-65N	6.5/10		17			46.7	16.5	5.9	21.9	45.1
	-80N	8/12		19			47.6	17.4	7.4	34.4	53.2
	-85N	8.5/12.5		19			47.6	17.4	7.8	38.2	55.6
1/2	KK6P-80N	8/12	19	19	53.4	31.0	17.4	7.4	34.4	60.5	
	-85N	8.5/12.5		17.4			7.8	38.2	62.8		
	-110N	11/16		24			24	57.2	20.1	10.2	65.4

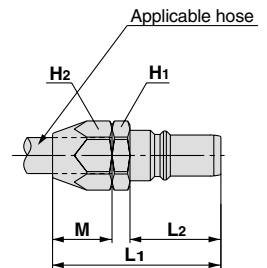

Straight type with One-touch fitting

(mm)



Body size	Model	Applicable tubing O.D.	øD1	øD2	L1	L2	M	Min. bore size	Effective area mm ²		Mass g		
									Urethane tubing	Nylon tubing			
M5	KK2P-23H	ø3.2	10.0	7.0	23.7	12.3	12.7	2.5	3.7	4.4	3.3		
	-04H	ø4		8.0					8.1	8.1	3.4		
	-06H	ø6		10.0					26.7	13.5	3.4	8.1	8.1
1/8	KK3P-04H	ø4	12.0	10.0	35.4	18.4	16.0	3.2	3.9	5.6	7.9		
	-06H	ø6	14.0	12.0					4.7	10.1	12.8	9.1	
	-08H	ø8	16.0	14.0					18.5	6.0	15.7	22.6	13.2
	-10H	ø10	19.0	17.0					21.0	6.0	22.6	22.6	17.6
1/4	KK4P-06H	ø6	14.0	12.0	46.2	25.2	17.0	4.7	10.1	12.8	22.3		
	-08H	ø8	16.0	14.0					18.5	6.2	19.8	22.6	23.0
	-10H	ø10	19.0	17.0					21.0	7.7	27.6	35.3	27.1
	-12H	ø12	21.0	19.0					22.0	9.0	40.2	50.9	30.0
1/2	KK6P-12H	ø12	21.0	19.0	56.1	31.0	22.0	9.2	41.2	50.9	44.4		
	-16H	ø16	26.0	23.8					25.0	13.0	—	106.2	50.7

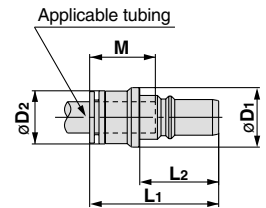

- K
- M
- H
- KK
- D
- MS
- LQ
- MQR
- T

Elbow type with One-touch fitting

(mm)



Body size	Model	Applicable tubing O.D.	øD1	øD2	L1	L2	L3	M	Min. bore size	Effective area mm ²		Mass g				
										Urethane tubing	Nylon tubing					
M5	KK2P-23L	ø3.2	10.0	9.3	24.0	12.3	16.5	12.7	2.5	3.6	4.3	5.8				
	-04L	ø4		11.6						25.1	16.6	13.5	3.4	7.8	7.8	6.4
	-06L	ø6		10.4						31.6	18.0	16.0	3.0	3.7	5.3	7.2
1/8	KK3P-04L	ø4	12.0	10.4	32.8	18.4	18.0	16.0	3.0	3.7	5.3	7.2				
	-06L	ø6	12.8	32.8						20.0	17.0	4.5	10.1	11.4	8.0	
	-08L	ø8	15.2	34.0						23.0	18.5	6.0	15.0	16.8	9.7	
	-10L	ø10	17.0	36.0						26.5	21.0	6.0	18.0	18.5	23.0	
1/4	KK4P-06L	ø6	14.0	12.8	40.2	25.2	20.0	17.0	4.5	10.1	11.4	19.6				
	-08L	ø8	15.2	41.4						23.0	18.5	6.0	17.5	19.8	21.3	
	-10L	ø10	17.0	42.8						26.5	21.0	7.5	24.7	27.5	25.7	
	-12L	ø12	19.0	44.0						28.5	22.0	9.0	29.0	29.6	28.0	
1/2	KK6P-12L	ø12	19.0	20.9	49.9	31.0	28.5	22.0	9.0	38.1	39.7	40.3				
	-16L	ø16	21.0	26.5						53.5	34.0	25.0	13.0	—	58.7	48.7

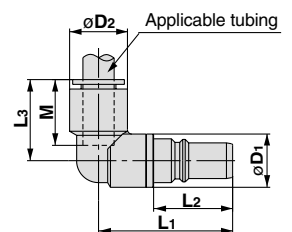

Bulkhead type with One-touch fitting

(mm)



Body size	Model	Applicable tubing O.D.	T Threads	H1 Width across flats	H2 Width across flats	L1	L2	L3	M	Min. bore size	Effective area mm ²		Mass g				
											Urethane tubing	Nylon tubing					
M5	KK2P-23E	ø3.2	M8 x 0.75	10	10	28.3	12.3	12.5	12.7	2.5	3.7	4.4	6.0				
	-04E	ø4	M9 x 0.75		11						12.7	13.5	3.4	8.1	8.1	6.6	
	-06E	ø6	M11 x 0.75		14						14	28.6	16.9	16.0	3.2	3.9	5.6
1/8	KK3P-04E	ø4	M12 x 1	17	17	40.2	18.4	16.8	17.0	4.7	10.1	12.8	22.3				
	-06E	ø6	M14 x 1		19						43.4	20.0	18.5	6.0	15.7	22.6	30.2
	-08E	ø8	M16 x 1		22						46.4	22.0	21.0	6.0	22.6	22.6	54.7
	-10E	ø10	M20 x 1		22						24	46.4	22.0	21.0	7.7	27.6	35.3
1/4	KK4P-06E	ø6	M14 x 1	17	17	47.0	25.2	16.8	17.0	4.7	10.1	12.8	30.6				
	-08E	ø8	M16 x 1		19						50.2	20.0	18.5	6.2	19.8	22.6	38.2
	-10E	ø10	M20 x 1		22						53.2	22.0	21.0	7.7	27.6	35.3	61.4
	-12E	ø12	M22 x 1		24						54.2	23.0	22.0	9.0	40.2	50.9	75.2
1/2	KK6P-12E	ø12	M22 x 1	24	27	60.1	31.0	23.0	22.0	9.2	41.2	50.9	86.1				
	-16E	ø16	M28 x 1.5		30						32	62.6	24.5	25.0	13.0	—	106.2

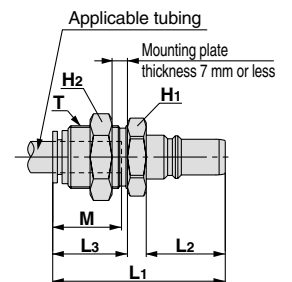

Series KK

Dimensions/Socket (S)

Male thread type

(mm)

KK2



KK3/4/6



Body size	Model	T Connection port size	H Width across flats	øD	L1	L2 When connected	A1*	A2* When connected	Min. bore size	Effective area mm ²	Mass g
M5	KK2S-M5M	M5 x 0.8	8	10.0	24.7	26.2	21.7	23.7	2.5	3.8	6.1
	-01MS	R 1/8	10		24.4	25.9		22.8			
1/8	KK3S-01MS	R 1/8	14	20.2	36.6	39.1	33.5	36.0	6.0	20.4	20.1
	-02MS	R 1/4			37.0	39.5	31.5	34.0			
	-03MS	R 3/8	17		37.6	40.1	32.2	34.5	9.0	21.1	29.0
1/4	KK4S-01MS	R 1/8	19	28.0	49.5	53.2	46.4	50.1	6.0	22.9	47.5
	-02MS	R 1/4			50.5	54.2	45.0	48.7			
	-03MS	R 3/8	17		48.9	52.6	43.5	47.2	11.0	40.4	50.9
	-04MS	R 1/2	22		48.8	52.5	41.7	45.4	13.0	42.7	61.2
1/2	KK6S-03MS	R 3/8	24	31.6	59.1	64.4	53.7	59.0	11.0	71.7	87.9
	-04MS	R 1/2			59.3	64.6	52.2	57.5			
	-06MS	R 3/4	27		60.2	65.5	50.7	56.0	15.0	83.8	113.3

* Reference dimension for R threads after installation.

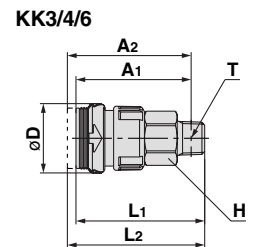
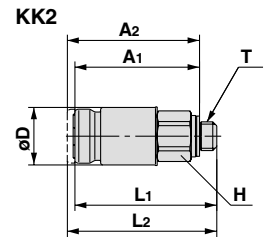

Female thread type

(mm)

KK2



KK3/4/6



Body size	Model	T Connection port size	H Width across flats	øD	L1	L2 When connected	Min. bore size	Effective area mm ²	Mass g
M5	KK2S-M5F	M5 x 0.8	8	10.0	25.3	26.8	4.2	5.4	6.4
	KK3S-01F	Rc 1/8	14		36.0	38.5		8.2	
1/8	-02F	Rc 1/4	17	20.2	40.1	42.6	8.2		21.1
	-03F	Rc 3/8	17		41.9	44.4		38.8	
1/4	KK4S-02F	Rc 1/4	19	28.0	50.4	54.1	10.9	39.6	56.9
	-03F	Rc 3/8			51.1	54.8		42.7	
1/2	KK6S-03F	Rc 3/8	24	31.6	58.6	63.9	14.4	83.1	93.6
	-04F	Rc 1/2			61.0	66.3		18.0	

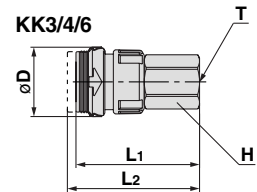
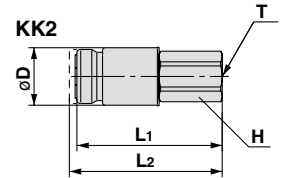

Nut fitting type (for fiber reinforced urethane hose)

(mm)



Body size	Model	Applicable hose I.D./O.D.	H1 Width across flats	H2 Width across flats	øD	L1	L2 When connected	M	Min. bore size	Effective area mm ²	Mass g
1/8	KK3S-50N	5/8	14	14	20.2	42.6	45.1	13.7	4.5	12.2	32.1
	-60N	6/9	17	17		44.4	46.9	16.5	5.4	18.3	48.7
	-65N	6.5/10				5.9	19.2	46.4			
1/4	KK4S-50N	5/8	19	17	28.0	54.1	57.8	13.7	4.5	12.2	55.8
	-60N	6/9				56.8	60.5	16.5	5.4	20.4	69.3
	-65N	6.5/10				5.9	24.1	66.8			
	-80N	8/12				7.4	35.1	68.5			
	-85N	8.5/12.5				7.8	36.6	71.1			
1/2	KK6S-80N	8/12	24	24	31.6	66.0	71.3	17.4	7.4	36.6	107.5
	-85N	8.5/12.5				7.8	41.2	110.2			
	-110N	11/16				64.4	69.7	20.1	10.2	68.4	119.8

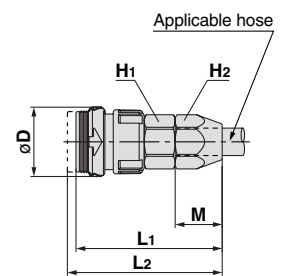

Straight type with One-touch fitting

(mm)

Body size	Model	Applicable tubing O.D.	øD1	øD2	L1	L2 When connected	M	Min. bore size	Effective area mm ²		Mass g		
									Urethane tubing	Nylon tubing			
M5	KK2S-23H	ø3.2	10.0	7.0	33.8	35.3	12.7	2.5	3.8	4.6	6.4		
	-04H	ø4		8.0	33.6	35.1			3.4	4.0	4.8	6.5	
	-06H	ø6		10.0	33.9	35.4			4.7	5.8	5.8	7.9	
1/8	KK3S-04H	ø4	20.2	10.0	46.6	49.1	16.0	3.2	3.8	5.8	22.5		
	-06H	ø6		12.0	47.1	49.6			4.7	10.4	13.4	24.4	
	-08H	ø8		14.0	48.9	51.4			18.5	6.2	16.8	18.9	27.3
	-10H	ø10		17.0	49.9	52.4			21.0	7.7	19.1	19.1	37.1
1/4	KK4S-06H	ø6	28.0	12.0	58.2	61.9	17.0	4.7	10.4	13.4	51.4		
	-08H	ø8		14.0	60.1	63.8			18.5	6.2	18.3	21.8	51.3
	-10H	ø10		17.0	61.5	65.2			21.0	7.7	27.0	29.4	54.8
	-12H	ø12		19.0	62.5	66.2			22.0	9.2	30.5	32.0	59.4
1/2	KK6S-12H	ø12	31.6	19.0	70.1	75.4	22.0	9.2	42.7	48.8	84.1		
	-16H	ø16		25.7	72.3	77.6			25.0	13.2	53.4	62.5	99.9

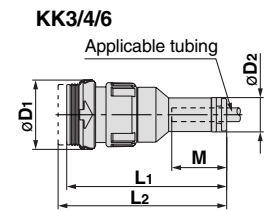
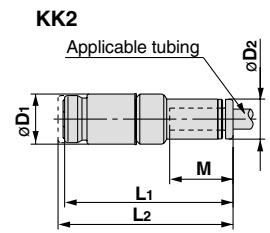

- K
- M
- H
- KK
- D
- MS
- LQ
- MQR
- T

Elbow type with One-touch fitting

(mm)

Body size	Model	Applicable tubing O.D.	øD1	øD2	L1	L2 When connected	L3	M	Min. bore size	Effective area mm ²		Mass g		
										Urethane tubing	Nylon tubing			
M5	KK2S-23L	ø3.2	10.0	9.3	26.0	27.5	16.5	12.7	2.5	3.7	4.4	6.7		
	-04L	ø4		11.6	27.2	28.3	16.6			4.5	5.6	5.6	7.2	
	-06L	ø6		10.4	41.7	44.2	18.0			16.0	3.0	3.7	5.3	23.2
1/8	KK3S-04L	ø4	20.2	12.8	42.9	45.4	20.0	17.0	4.5	10.1	11.4	24.0		
	-06L	ø6		15.2	43.1	45.6	23.0			18.5	6.0	15.0	16.8	25.0
	-08L	ø8		18.5	42.9	45.4	26.5			21.0	7.5	18.0	18.5	34.4
	-10L	ø10		12.8	54.3	58.0	20.0			17.0	4.5	10.1	11.4	53.5
1/4	KK4S-06L	ø6	28.0	15.2	55.5	59.2	23.0	18.5	6.0	17.5	19.8	53.1		
	-08L	ø8		18.5	54.2	57.9	26.5			21.0	7.5	24.7	27.5	54.7
	-10L	ø10		20.9	55.4	59.1	28.5			22.0	9.0	29.0	29.6	57.0
	-12L	ø12		26.5	66.3	71.6	34.0			25.0	13.0	38.1	39.7	91.4
1/2	KK6S-12L	ø16	31.6	26.5	66.9	72.2	34.0	25.0	13.0	50.3	58.7	93.5		

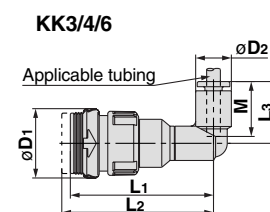
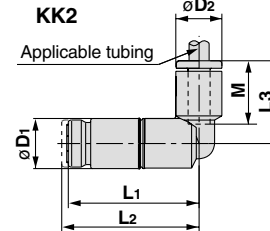

Bulkhead type with One-touch fitting

(mm)

Body size	Model	Applicable tubing O.D.	T Threads	H1 Width across flats	H2 Width across flats	øD	L1	L2 When connected	L3	M	Min. bore size	Effective area mm ²		Mass g			
												Urethane tubing	Nylon tubing				
M5	KK2S-23E	ø3.2	M8 x 0.75	10	10	10.0	33.8	35.3	13.0	12.7	2.5	3.8	4.6	9.6			
	-04E	ø4	M9 x 0.75		11		33.5	35.0				3.4	4.0	4.8	9.1		
	-06E	ø6	M11 x 0.75		14		33.9	35.4				13.1	13.5	4.7	5.8	5.8	12.6
1/8	KK3S-04E	ø4	M12 x 1	14	14	20.2	46.6	49.1	16.9	16.0	3.2	3.8	5.8	29.0			
	-06E	ø6	M14 x 1		17		47.1	49.6				16.8	17.0	4.7	10.4	13.4	39.4
	-08E	ø8	M16 x 1		17		49.0	51.5				20.0	18.5	6.2	16.8	18.9	43.4
	-10E	ø10	M20 x 1		22		49.9	52.4				22.0	21.0	7.7	19.1	19.1	68.3
1/4	KK4S-06E	ø6	M14 x 1	19	17	28.0	58.2	61.9	16.8	17.0	4.7	10.4	13.4	57.2			
	-08E	ø8	M16 x 1		19		60.1	63.8				20.0	18.5	6.2	18.3	21.8	60.6
	-10E	ø10	M20 x 1		22		61.7	65.4				22.0	21.0	7.7	27.0	29.4	86.8
	-12E	ø12	M22 x 1		24		62.7	66.4				23.0	22.0	9.2	30.5	32.0	105.7
1/2	KK6S-12E	ø12	M22 x 1	24	27	31.6	70.1	75.4	24.5	25.0	9.2	42.7	48.8	116.0			
	-16E	ø16	M28 x 1.5		30		72.5	77.8				25.0	13.2	53.4	62.5	183.2	

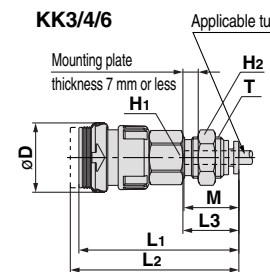
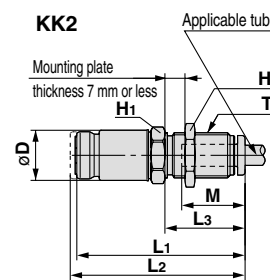

S Couplers

Series KKH



- Able to absorb drop impact (equivalent to impact energy of 0.5 J).
- The pulling strength for the plugs and sockets has been improved. Twice as strong as the conventional models.

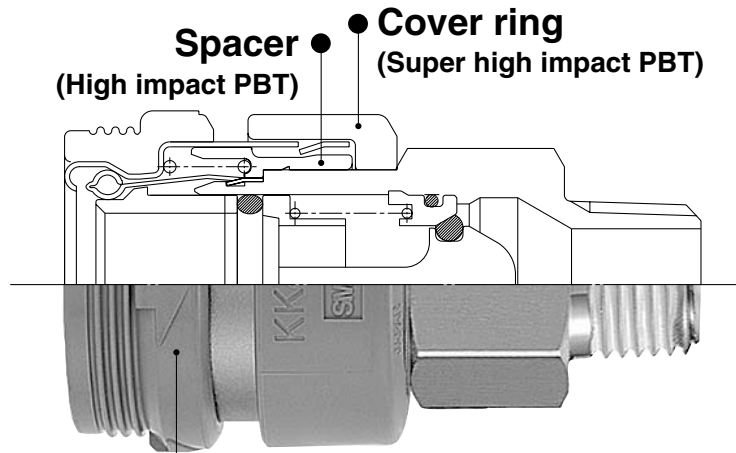

Sleeve cover ●
(Rubber)

- Same effective sectional area as that of Series KK.

Plug (P)

Socket (S)

Male thread type

	Body size	Connection port size	Part no.
	1/8	R 1/8	
R 1/4			-02MS
R 3/8			-03MS
1/4	R 1/8		KK4P-01MS
	R 1/4		-02MS
	R 3/8		-03MS
	R 1/2		-04MS

Male thread type

	Body size	Connection port size	Part no.
	1/8	R 1/8	
R 1/4			-02MS
R 3/8			-03MS
1/4	R 1/8		KKH4S-01MS
	R 1/4		-02MS
	R 3/8		-03MS
	R 1/2		-04MS

Female thread type

	Body size	Connection port size	Part no.
	1/8	Rc 1/8	
Rc 1/4			-02F
Rc 3/8			-03F
1/4	Rc 1/4		KK4P-02F
	Rc 3/8		-03F

Female thread type

	Body size	Connection port size	Part no.
	1/8	Rc 1/8	
Rc 1/4			-02F
Rc 3/8			-03F
1/4	Rc 1/4		KKH4S-02F
	Rc 3/8		-03F

Nut fitting type (for fiber reinforced urethane hose)

	Body size	Applicable hose I.D./O.D. mm	Part no.
	1/8	5/8	
6/9			-60N
6.5/10			-65N
1/4	5/8		KK4P-50N
	6/9		-60N
	6.5/10		-65N
	8/12		-80N
	8.5/12.5		-85N

Nut fitting type (for fiber reinforced urethane hose)

	Body size	Applicable hose I.D./O.D. mm	Part no.
	1/8	5/8	
6/9			-60N
6.5/10			-65N
1/4	5/8		KKH4S-50N
	6/9		-60N
	6.5/10		-65N
	8/12		-80N
	8.5/12.5		-85N

Series KKH are only available as sockets.
Series KK should be used as plugs.

S Couplers Series *KKH*



JIS Symbol

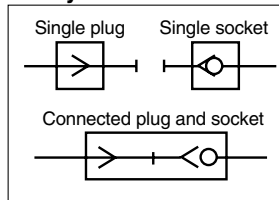

Specifications

Fluid	Air, Water
Operating pressure range <small>Note)</small>	KKH3: -90 kPa to 1 MPa KKH4: 0 to 1 MPa
Proof pressure	1.5 MPa
Ambient and fluid temperature	Air: -5 to 60°C Water: 5 to 40°C (No freezing)
Plating, Sealant	Electroless nickel plated (copper-free and fluorine-free application), With male thread sealant
Connection plug	Series KK plug

Note) Do not use the S couplers with a leak tester or for vacuum retention because they are not guaranteed for zero leakage.

Performance

Plug and socket connection	One-touch connection and release
Check valve	Socket: Built-in check valve (standard)
Sleeve lock mechanism	—

Effective Area

Body size	Plug	Socket	Effective area mm ²
1/8	KK3P-01MS	KKH3S-01MS	20
1/4	KK4P-02MS	KKH4S-02MS	39

The flow characteristics are the same as those of Series KK.
Please refer to page 168.

How to Order

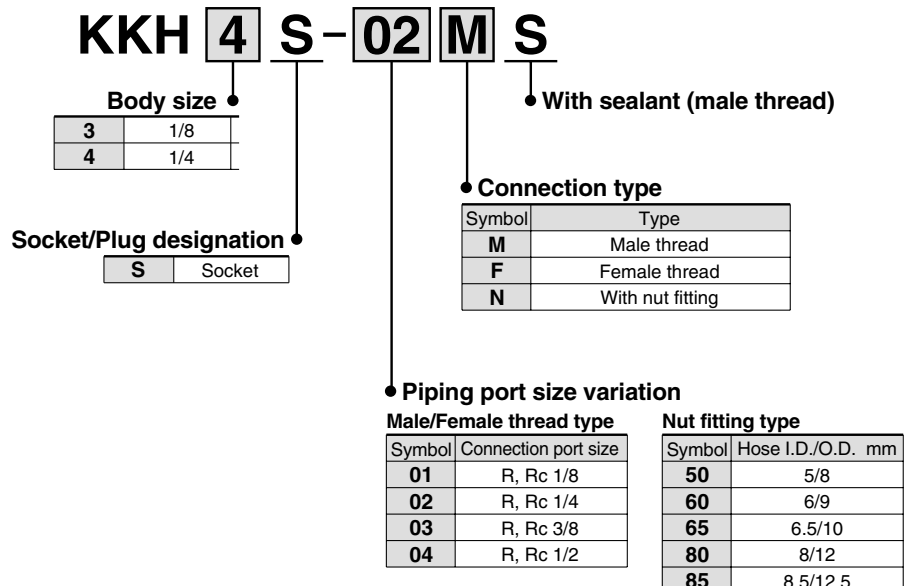

Series KKH

Dimensions/Socket (S)

Male thread type

(mm)



Body size	Model	T Connection port size	H Width across flats	øD	L1	L2 When connected	A1*	A2* When connected	Min. bore size	Effective area mm ²	Mass g
1/8	KKH3S-01MS	R 1/8	14	20.2	36.6	39.1	33.5	36.0	6.0	20.4	20.3
	-02MS	R 1/4			37.0	39.5	31.5	34.0	9.0	21.1	19.4
	-03MS	R 3/8	17		37.6	40.1	32.2	34.5	9.0	27.7	
1/4	KKH4S-01MS	R 1/8	19	28.0	49.5	53.2	46.4	50.1	6.0	22.9	48.7
	-02MS	R 1/4			50.5	54.2	45.0	48.7	9.0	38.9	45.3
	-03MS	R 3/8	17		48.9	52.6	43.5	47.2	11.0	40.4	52.1
	-04MS	R 1/2	22		48.8	52.5	41.7	45.4	13.0	42.7	62.4

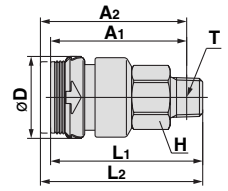

* Reference dimension for R threads after installation.

Female thread type

(mm)



Body size	Model	T Connection port size	H Width across flats	øD	L1	L2 When connected	Min. bore size	Effective area mm ²	Mass g
1/8	KKH3S-01F	Rc 1/8	14	20.2	36.0	38.5	8.2	20.6	23.8
	-02F	Rc 1/4	17		40.1	42.4		21.1	33.1
	-03F	Rc 3/8	19		41.9	44.3		37.1	
1/4	KKH4S-02F	Rc 1/4	19	28.0	50.4	54.1	10.9	39.6	58.1
	-03F	Rc 3/8			51.1	54.8	14.4	42.7	47.4

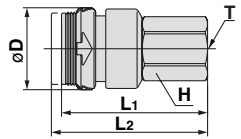

Nut fitting type (for fiber reinforced urethane hose)

(mm)



Body size	Model	Applicable hose I.D./O.D.	H1 Width across flats	H2 Width across flats	øD	L1	L2 When connected	M	Min. bore size	Effective area mm ²	Mass g
1/8	KKH3S-50N	5/8	14	14	20.2	42.6	45.1	13.7	4.5	12.2	32.3
	-60N	6/9	17	17		44.4	46.9	16.5	5.4	18.3	48.9
	-65N	6.5/10				5.9	19.2	46.6			
1/4	KKH4S-50N	5/8	19	14	28.0	54.1	57.8	13.7	4.5	12.2	57.0
	-60N	6/9		17		56.8	60.5	16.5	5.4	20.4	70.5
	-65N	6.5/10	17	5.9		24.1	68.0				
	-80N	8/12	19	7.4		35.1	69.7				
	-85N	8.5/12.5		7.8		36.6	72.3				

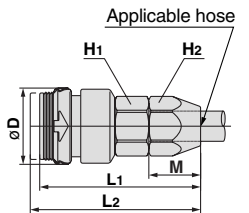

Series KKH are only available as sockets. Series KK should be used as plugs. For dimensions, please refer to page 170.



S Couplers Specific Product Precautions 1

Be sure to read before handling. Refer to front matters 58 and 59 for Safety Instructions and pages 13 to 16 for Fittings and Tubing Precautions.

Selection

⚠ Warning

1. Make sure to confirm the specifications.
Please do not use with pressures or temperatures outside the range of specifications, as this may result in damage and malfunction (Refer to specifications). SMC takes no responsibility for damage incurred by use in excess of the specification range.
2. Prohibition of disassembly and modification
Do not disassemble or modify (including additional machining) the main body.
False use may cause an injury or accident.
3. Confirm that PTFE can be used in application.
Thread sealant contains PTFE (polytetrafluoroethylene) powder. Confirm if the use of it may cause any adverse effect in the system.
4. Cannot be used as a stop valve that requires zero leakage.
A certain amount of leakage is allowed during operation.
5. Series KK and Series KKH cannot be connected with Series KKA. Also, SMC's S coupler cannot be connected with quick couplers of other brands.
This will cause leakage, damage, and disconnection of the plug.
With series KK13, manufactured by RECTUS AG, verify the manufacturer of applicable couplers before use.
6. Do not couple or uncouple the S coupler during pressurization or while residual pressure remains. The coupler may shoot out under the influence of the pressure.
7. Never apply pressure to an S coupler without check valve when it is uncoupled. The piping may move violently and cause danger.
8. An S coupler without check valve experiences leakage of fluid inside piping when it is uncoupled. Pay special attention in using fluid that can cause danger such as fluid of a high temperature and pressure. Additional use of a stop valve is recommended.
9. The S coupler is heated when used at a high temperature. Take precautions not to touch it since touching it can cause burns.

⚠ Caution

1. For a plug and socket connection, select a plug and socket with the same body size. If their body sizes are different, they cannot be connected. This will cause leakage, damage, and disconnection of the plug. Inserting a plug other than the specialized plug into the socket may result in equipment damage.
2. Do not use in locations where the connecting threads and tubing connection will slide or rotate. The connecting threads and tubing connection will come apart under these conditions.
3. Do not use couplers with flammable, explosive, or toxic substances, such as gas, gas fuel, and refrigerant. They may leak from inside the tubing to the outside.
4. Operate with a surge pressure of no more than the maximum operating pressure. If the surge pressure exceeds the maximum operating pressure, it will cause damage to couplers and tubing.
5. Do not use the S coupler with steam. Corrosion of the metal material and deterioration of the sealing material may result from long-term use with steam.

Mounting

⚠ Warning

1. Mount and operate the product after reading the instruction manual carefully and understanding its contents. Also, keep the manual where it can be referred to as necessary.
2. Ensure sufficient space for maintenance.
Be sure to allow the space required for maintenance and inspection.
3. Tightening torque
When installing the products, please tighten the screw with the recommended tightening torque.
4. During use, tube deterioration or damage to fitting can result in disconnection of the tube from the fitting and uncontrollable behavior of the tube.
To stop the tube from going out of control, use a protective cover or fix the tube in place.
5. Do not use couplers where rotation normally occurs. The couplers may be damaged.
6. Avoid applications in which vibration or shock is directly applied to the fittings.
7. Fittings with sleeve lock mechanism must be locked during operation in order to prevent sudden disconnection.
8. Install a stop valve at the supply pressure side of the socket. Emergency shutdown may not be possible without it.

⚠ Caution

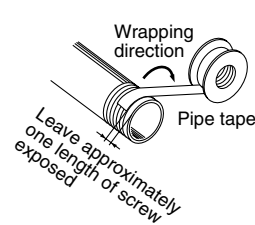
1. Preparation before piping
Before piping is connected, it should be thoroughly blown out by air (flushed) or washed to eliminate cutting chips, cutting oil, and other debris from inside the pipe.
2. Wrapping of pipe tape
When screwing in the pipes or fittings, make sure to prevent cutting chips or the sealing material on the threaded portion of the pipe from entering the piping. Also, if pipe tape is used, leave about 1 thread ridges exposed at the end of the threads.

3. Before mounting confirm the model and size, etc. Also, confirm that there are no blemishes, nicks or cracks in the product.
4. When connecting a tube, consider factors such as changes in the tubing length due to pressure, and allow sufficient leeway.
5. Mount so that couplers and tubing are not subjected to twisting, pulling or moment loads. This can cause damage to couplers and flattening, bursting or disconnection of tubing, etc.
6. Mount so that tubing is not damaged due to tangling and abrasion. This can cause flattening, bursting or disconnection of tubing, etc.



S Couplers Specific Product Precautions 2

Be sure to read before handling. Refer to front matters 58 and 59 for Safety Instructions and pages 13 to 16 for Fittings and Tubing Precautions.

Air Supply

⚠ Warning

1. Excessive drainage
Compressed air containing large amounts of drainage can cause malfunction of pneumatic equipment. As a countermeasure, install an air dryer or drain catch before the filter.
2. Drain flushing
If the drain removal from air filter is missed, drain will be flown out to the outlet side and may result in a malfunction of the pneumatic equipment. When removing drain is difficult, use of a filter with an auto drain is recommended.

Refer to SMC's "Air Cleaning Equipment" catalog for further details on compressed air quality.

3. Use clean air.
If the compressed air includes chemicals, synthetic oils containing organic solvents, salt or corrosive gases, etc., it can cause damage or malfunctions in the system.

⚠ Caution

1. Install an air filter.
Install an air filter upstream, near the valve.
Select an air filter with a filtration degree of 5 μm or finer.
2. Compressed air containing large amounts of drainage can cause malfunction of pneumatic equipment. As a countermeasure, install an aftercooler, air dryer or drain catch.
3. Ensure that the fluid and ambient temperature are within the specified range.
If the fluid temperature is 5°C or below, the moisture in the circuit could freeze, causing damage to the seals and leading to equipment malfunction. Therefore, take appropriate measures to prevent freezing.

Refer to SMC's "Air Cleaning Equipment" catalog for further details on compressed air quality.

Operating Environment

⚠ Warning

1. Do not use in atmospheres of corrosive gases, chemicals, salt water, water, steam, or where there is direct contact with any of these.
2. Do not use in direct sunlight.
3. In locations near heat sources, protect against radiated heat.
4. Do not use in locations where static electric charges will be a problem. Consult with SMC regarding use in this kind of environment.
5. Do not use in locations where spatter occurs.
There is a danger of spatter causing a fire. Consult with SMC regarding use in this kind of environment.

Operating Environment

⚠ Warning

6. Do not use in environments where there is direct contact with liquids such as cutting oil, lubricating oil or coolant oil, etc. Consult SMC regarding use in environments where there will be direct contact with cutting oil, lubricating oil or coolant oil, etc.
7. Do not use in locations influenced by vibrations or impacts. This may cause air leakage and fitting damage. Consult SMC regarding use in this kind of environment.
8. Do not use in places or environments where foreign matter sticks to the product or gets inside the product. It may cause air leakage or tube release.

Maintenance

⚠ Caution

1. Follow the procedures given in the operation manual to perform a maintenance inspection.
Improper handling could lead to malfunction or damage the machinery and equipment.
2. Maintenance work
If handled improperly, compressed air can be dangerous. Assembly, handling, repair and element replacement of pneumatic systems should be performed by qualified personnel only.
3. Drain flushing
Remove drainage from air filters regularly.
4. Removal of equipment, and supply/exhaust of compressed air
When components are removed, first confirm that measures are in place to prevent workpieces from dropping, run-away equipment, etc. Then, cut the supply pressure and power, and exhaust all compressed air from the system using the residual pressure release function.
When machinery is restarted, proceed with caution after confirming that appropriate measures are in place to prevent cylinders from sudden movement.
5. Be absolutely sure to wear safety glasses when conducting periodic inspections.
6. Check for the following during regular maintenance, and replace components as necessary.
 - a) Scratches, gouges, abrasion, corrosion
 - b) Leakage
 - c) Twisting, flattening or distortion of tubing
 - d) Hardening, deterioration or softness of tubing
7. Do not repair or patch the replaced tubing or couplers for reuse.
Do not disassemble the S coupler.

K

M

H

KK

D

MS

LQ

MQR

T



S Couplers Specific Product Precautions 3

Be sure to read before handling. Refer to front matters 58 and 59 for Safety Instructions and pages 13 to 16 for Fittings and Tubing Precautions.

Handling

⚠ Caution

- When connecting the plug, hold the plug securely. The plug may be uncoupled due to reaction at the time of connection.
- When connecting a plug, insert it securely until a click sound is heard from the socket. After the connection, gently pull the plug to see whether it will release. If not securely inserted, the plug may pop out due to the pressure. Also, do not touch the sleeve until the plug is securely inserted. Otherwise, it may lead to a malfunction.
- When connecting the plug, insert it straight into the socket. If not inserted straight, the socket and/or plug may be damaged or cause a malfunction.
- When releasing the plug, hold it securely. The connection pipe may move due to reacting stress and/or residual pressure on the plug side.
- Do not press the inside of the socket with an incompatible plug and/or with a stick. The internal fluid may be ejected and cause a dangerous situation. Also, the ejecting internal fluid may cause the sealings to come apart resulting in the product not functioning.

Plug Insertion Force in Pressurized Condition

Insertion Force of Series KK

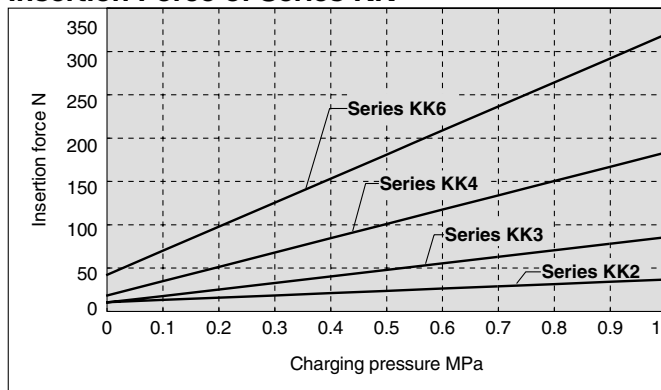

Insertion Force of Series KKA

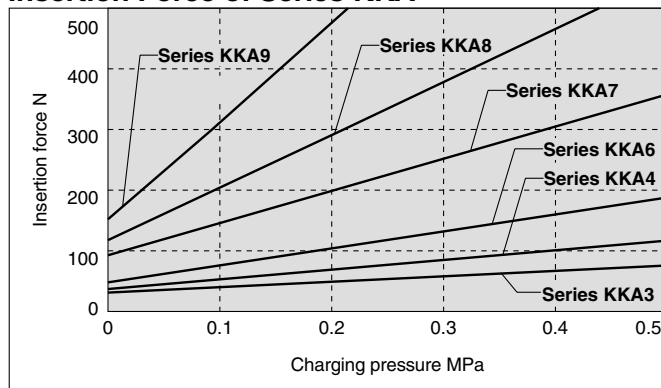

Handling of One-touch Fittings

⚠ Caution

- Tube attachment/detachment for One-touch fittings
 - Attaching of tubing
 - Take a tube having no flaws on its periphery and cut it off at a right angle. When cutting the tubing, use tubing cutters TK-1, 2 or 3. Do not use pinchers, nippers or scissors, etc. If cutting is done with tools other than tubing cutters, the tubing may be cut diagonally or become flattened, etc. This can make a secure installation impossible, and cause problems such as the tubing pulling out after installation or air leakage. Allow some extra length in the tubing.
 - Outside diameter of polyurethane tubing is swelled by applying internal pressure. As such, it may be that the tubing cannot be re-inserted into a one-touch fittings. Make sure to confirm the tubing outside diameter, and when the accuracy of the outside diameter is more than + 0.15, insert into a one-touch fitting again, not cutting the tubing to use it. When tubing is re-inserted into a one-touch fitting, make sure to confirm that the tubing was able to go through the release bushing smoothly.
 - Grasp the tubing and push it in slowly, inserting it securely all the way into the fitting.
 - After inserting the tubing, pull on it lightly to confirm that it will not come out. If it is not installed securely all the way into the fitting, this can cause problems such as air leakage or the tubing pulling out.
 - When attaching tubes, resin plugs, metal rods, etc., do not push the release button while attaching. Also, do not push the release button before attaching. This may cause releasing.
 - Detaching of tubing
 - Push in the release bushing sufficiently. When doing this, push the collar evenly.
 - Pull out the tubing while holding down the release bushing so that it does not come out. If the release bushing is not pressed down sufficiently, there will be increased bite on the tubing and it will become more difficult to pull it out.
 - When the removed tubing is to be used again, cut off the portion which has been chewed before reusing it. If the chewed portion of the tubing is used as is, this can cause trouble such as air leakage or difficulty in removing the tubing.
- When attaching resin plugs or metal rods to the tube, do not push the release button while attaching. This may cause releasing.
- Connecting products with attached metal rods
 - After attaching products with attached metal rods such as the KC series, to the one-touch fitting, please do not use tubes, resin plugs, or reducers, etc. This may cause releasing.



S Couplers Specific Product Precautions 4

Be sure to read before handling. Refer to front matters 58 and 59 for Safety Instructions and pages 13 to 16 for Fittings and Tubing Precautions.

Recommended piping conditions

- When installing piping in the one-touch fitting, please make sure there is sufficient slack to the tube length as per the recommended piping conditions shown in Figure 1. Also, when binding pipes together with a unifying band, etc., make sure piping is carried out without receiving external force (See Fig. 2).

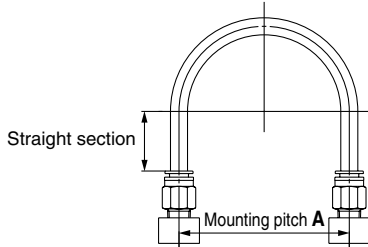

Fig. 1 Recommended piping

Unit: mm

Tubing size	Mounting pitch A			Straight section
	Nylon tube	Soft nylon tube	Polyurethane tube	
ø3.2, 1/8"	44 or more	29 or more	25 or more	16 or more
ø4, 5/32"	56 or more	30 or more	26 or more	20 or more
ø3/16"	67 or more	38 or more	38 or more	24 or more
ø6	84 or more	39 or more	39 or more	30 or more
ø1/4"	89 or more	56 or more	57 or more	32 or more
ø8, 5/16"	112 or more	58 or more	52 or more	40 or more
ø10	140 or more	70 or more	69 or more	50 or more
ø3/8"	134 or more	76 or more	69 or more	48 or more
ø12	168 or more	82 or more	88 or more	60 or more
ø1/2"	178 or more	118 or more	93 or more	64 or more
ø16	224 or more	144 or more	114 or more	80 or more

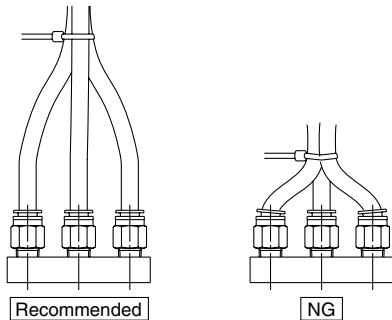

Fig. 2 When using a unifying band to bind together the pipes

Handling of Barb Fittings and Nut Fittings

Caution

- When using a nut fitting, insert the hose all the way to the end and securely tighten it with the nut. When the insertion of the hose or the tightening of the nut are not sufficient, the hose may slip out.
- Disconnection may occur depending on the material or the O.D. accuracy of the hose; therefore be sure to confirm the applicability of the hose.

Handling of Fittings

Caution

- Tightening of the M5-size connection threads
 - Tighten it by hand, then give it an additional 1/6 turn with a wrench. As a guideline, the tightening torque should be 1 to 1.5 N·m.
 - Over tightening can cause damage to the threads and/or air leakage due to deformation of the gasket.
 - Insufficient tightening can cause the threads to loosen and/or air to leak out.
- Tightening of the fittings with a sealant
 - Tighten fittings with sealant using the proper tightening torques in the table below. As a rule, they should be tightened 2 to 3 turns with a tool after first tightening by hand.

Connection thread size	Proper tightening torque N·m
NPT, R 1/8	7 to 9
NPT, R 1/4	12 to 14
NPT, R 3/8	22 to 24
NPT, R 1/2	28 to 30
NPT, R 3/4	28 to 30
NPT, R 1	36 to 38
NPT, R 1 1/4	40 to 42
NPT, R 1 1/2	48 to 50

- When a fitting is over tightened, more of the sealant material is squeezed out. Remove the squeezed out sealant material.
- When tightening is not sufficient, it will cause sealant failure or a loose fitting.
- Re-using
 - Normally, a fitting with sealant can be re-used 2 to 3 times.
 - Remove the sealant material that is separated and adhering to a removed fitting with air blow, etc. If the separated sealant enters into nearby equipment, it will cause air leakage or malfunction.
 - When the sealant is no longer effective, wrap sealant tape over the sealant material and re-use the fitting. Do not use a sealant material other than sealant tape.
- In cases where positioning is required, turning the fitting in the reverse direction after tightening will cause air leakage.

Precautions on Other Tubing Brands

Caution

- When using tubing brands other than SMC, confirm that the tubing outside diameter tolerances satisfy the following specifications.
 - Nylon tubing within ± 0.1 mm
 - Soft nylon tubing within ± 0.1 mm
 - Polyurethane tubing within $+0.15$ mm
within -0.2 mm

When the tube O.D. accuracy is not satisfactory and measurement of the internal diameter dimensions does not match the dimensions provided by SMC, do not use. The tube may not connect, or leaks, tube disconnection, or damage to fittings may occur.

K
M
H
KK
D
MS
LQ
MQR
T

S Couplers

Series KKA

Stainless steel type



- **Body material: Stainless steel 304**
Seal material: Fluoro rubber (Special FKM)
- **Both plug and socket have an integral check valve.**
Available with and without check valves depending on the operating conditions.
- **Reduces liquid dripping when the plug and socket are uncoupled.**
Liquid dripping: 0.02 to 0.77 cm³ at each removal
Aeration: 0.1 to 2.7 cm³ at each removal

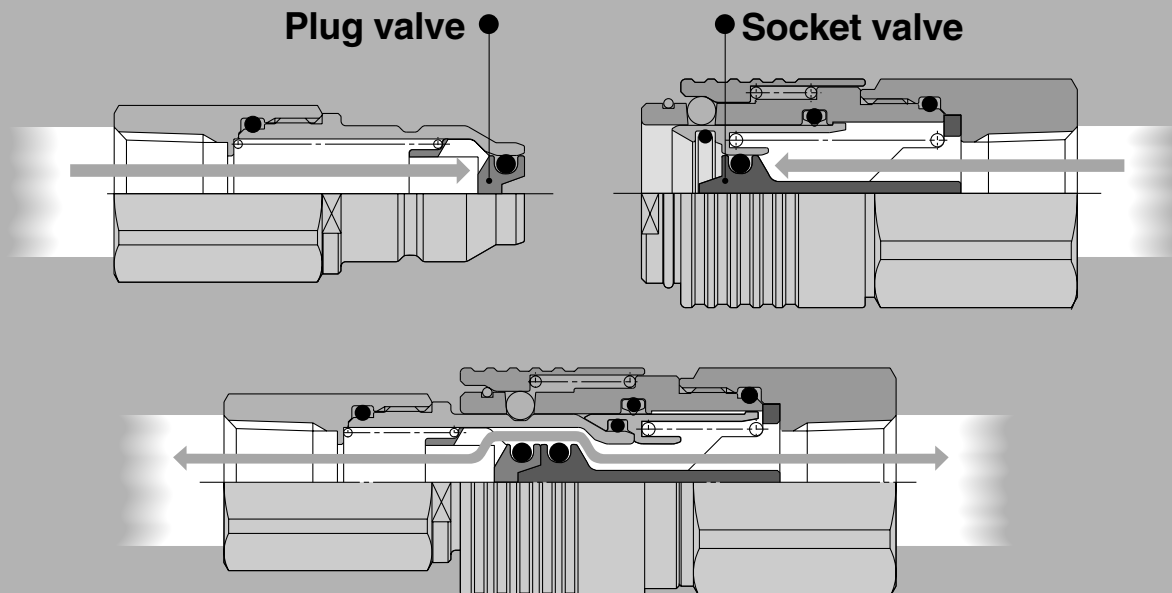







- **Non-greased specification (standard)**
Allows smooth installation and removal even without grease
 - O-ring: Fluorine coated
 - Sliding parts of plug and socket: Plated with fluorine-contained material
- **Fluid: Water, Air**
- **Operating temperature range: -5 to 150°C**
Note) This product should not be used with steam.

K	<input type="checkbox"/>
M	<input type="checkbox"/>
H	<input type="checkbox"/>
KK	<input checked="" type="checkbox"/>
D	<input type="checkbox"/>
MS	<input type="checkbox"/>
LQ	<input type="checkbox"/>
MQR	<input type="checkbox"/>
T	<input type="checkbox"/>







Series KKA

Plug (P)

Male thread type







	Body size	Port size	Part no.	
			With check valve	Without check valve
	1/8	R 1/8	KKA3P-01M	KKA3P-01M-1
		R 1/4	-02M	-02M-1
		R 3/8	-03M	-03M-1
	1/4	R 1/4	KKA4P-02M	KKA4P-02M-1
		R 3/8	-03M	-03M-1
		R 1/2	-04M	-04M-1
	1/2	R 3/8	KKA6P-03M	KKA6P-03M-1
		R 1/2	-04M	-04M-1
		R 3/4	-06M	-06M-1
	3/4	R 1/2	KKA7P-04M	—
		R 3/4	-06M	—
		R 1	-10M	—
	1	R 3/4	KKA8P-06M	—
		R 1	-10M	—
		R 1 1/4	-12M	—
	1 1/4	R 1	KKA9P-10M	—
		R 1 1/4	-12M	—
		R 1 1/2	-14M	—

Female thread type







	Body size	Port size	Part no.	
			With check valve	Without check valve
	1/8	Rc 1/8	KKA3P-01F	KKA3P-01F-1
		Rc 1/4	-02F	-02F-1
		Rc 3/8	-03F	-03F-1
	1/4	Rc 1/4	KKA4P-02F	KKA4P-02F-1
		Rc 3/8	-03F	-03F-1
		Rc 1/2	-04F	-04F-1
	1/2	Rc 3/8	KKA6P-03F	KKA6P-03F-1
		Rc 1/2	-04F	-04F-1
		Rc 3/4	-06F	-06F-1
	3/4	Rc 1/2	KKA7P-04F	—
		Rc 3/4	-06F	—
		Rc 1	-10F	—
	1	Rc 3/4	KKA8P-06F	—
		Rc 1	-10F	—
		Rc 1 1/4	-12F	—
	1 1/4	Rc 1	KKA9P-10F	—
		Rc 1 1/4	-12F	—
		Rc 1 1/2	-14F	—

Socket (S)

Male thread type

	Body size	Port size	Part no.	
			With check valve	Without check valve
	1/8	R 1/8	KKA3S-01M	KKA3S-01M-1
		R 1/4	-02M	-02M-1
		R 3/8	-03M	-03M-1
	1/4	R 1/4	KKA4S-02M	KKA4S-02M-1
		R 3/8	-03M	-03M-1
		R 1/2	-04M	-04M-1
	1/2	R 3/8	KKA6S-03M	KKA6S-03M-1
		R 1/2	-04M	-04M-1
		R 3/4	-06M	-06M-1
	3/4	R 1/2	KKA7S-04M	—
		R 3/4	-06M	—
		R 1	-10M	—
	1	R 3/4	KKA8S-06M	—
		R 1	-10M	—
		R 1 1/4	-12M	—
	1 1/4	R 1	KKA9S-10M	—
		R 1 1/4	-12M	—
		R 1 1/2	-14M	—

Female thread type

	Body size	Port size	Part no.	
			With check valve	Without check valve
	1/8	Rc 1/8	KKA3S-01F	KKA3S-01F-1
		Rc 1/4	-02F	-02F-1
		Rc 3/8	-03F	-03F-1
	1/4	Rc 1/4	KKA4S-02F	KKA4S-02F-1
		Rc 3/8	-03F	-03F-1
		Rc 1/2	-04F	-04F-1
	1/2	Rc 3/8	KKA6S-03F	KKA6S-03F-1
		Rc 1/2	-04F	-04F-1
		Rc 3/4	-06F	-06F-1
	3/4	Rc 1/2	KKA7S-04F	—
		Rc 3/4	-06F	—
		Rc 1	-10F	—
	1	Rc 3/4	KKA8S-06F	—
		Rc 1	-10F	—
		Rc 1 1/4	-12F	—
	1 1/4	Rc 1	KKA9S-10F	—
		Rc 1 1/4	-12F	—
		Rc 1 1/2	-14F	—

S Couplers Series KKA

Stainless steel type



JIS Symbol

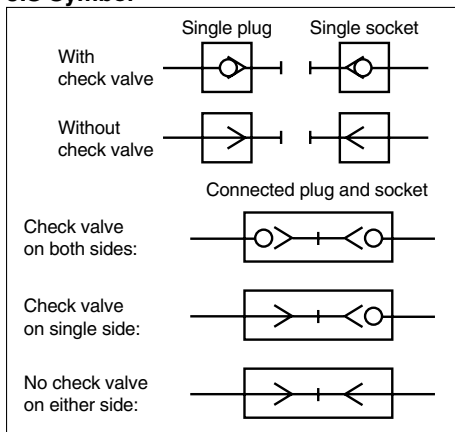

Characteristics with check valve on both sides

Body size	Liquid dripping cm ³ at each removal	Aeration cm ³ at each removal
KKA3	0.02	0.1
KKA4	0.04	0.1
KKA6	0.06	0.2
KKA7	0.14	0.5
KKA8	0.27	0.9
KKA9	0.77	2.7

Liquid dripping:

Volume of water leakage at the time when the plug and socket are uncoupled.

Aeration:

Volume of external air entrained when the plug and socket are connected.

Specifications

Fluid	Water, Air
Operating pressure range ^{Note 1)}	KKA3: -100 kPa to 1 MPa KKA4/6/7/8/9: 0 to 1 MPa
Proof pressure	10 MPa
Ambient and fluid temperature	-5 to 150°C (No freezing) ^{Note 2)} This product should not be used with steam.
Non-greased specification	No grease is used. Rubber: Fluorine coated, (Metal sliding parts: Plated with fluorine-contained material)
Material	Metal part: Stainless steel 304, Rubber material: Fluoro rubber (Special FKM)
Seal	With male thread sealant

Note 1) Do not use the S couplers with a leak tester or for vacuum retention because they are not guaranteed for zero leakage.

Note 2) When fluid contains copper ions, please use KKA□-X70. (p. 275)

Performance

Plug and socket connection	One-touch connection and release
Check valve	Check valve on both sides, Without check valve

Note) Series KKA cannot be connected with Series KK or Series KKH.

Effective Area

	Built-in check valve	Plug	Socket	Effective area mm ²
Plug: With check valve Socket: With check valve		KKA3P-01F	KKA3S-01F	17.4
		KKA4P-02F	KKA4S-02F	26.4
		KKA6P-04F	KKA6S-04F	54.2
		KKA7P-06F	KKA7S-06F	99.6
		KKA8P-10F	KKA8S-10F	168.3
		KKA9P-12F	KKA9S-12F	332.1
Plug: Without check valve Socket: With check valve		KKA3P-01M-1	KKA3S-01M	18.5
		KKA4P-02M-1	KKA4S-02M	31.8
		KKA6P-04M-1	KKA6S-04M	55.3
Plug: Without check valve Socket: Without check valve		KKA3P-01M-1	KKA3S-01M-1	22.6
		KKA4P-02M-1	KKA4S-02M-1	40.2
		KKA6P-04M-1	KKA6S-04M-1	76.0

How to Order

KKA 4 P - 02 M

Body size

3	1/8
4	1/4
6	1/2
7	3/4
8	1
9	1 1/4

Socket/Plug designation

P	Plug
S	Socket

Port size

Symbol	Thread size
01	R, Rc 1/8
02	R, Rc 1/4
03	R, Rc 3/8
04	R, Rc 1/2
06	R, Rc 3/4
10	R, Rc 1
12	R, Rc 1 1/4
14	R, Rc 1 1/2

Built-in check valve

Nil	With check valve
-1	Without check valve

Note) KKA7/8/9 is not available without a check valve. Contact us when such a type is needed.

Connection type

Symbol	Type
M	Male thread (with sealant)
F	Female thread

Built-in check valve	Plug	Socket	Availability
	Yes	Yes	○
	No	Yes	○
	No	No	○
	Yes	No	×

Note) A plug with check valve should be used in combination with a socket with check valve.
If a socket without check valve is used, the check valve of the plug will not open.

Series KKA

Flow Characteristics

Air

Plug: With check valve Socket: With check valve

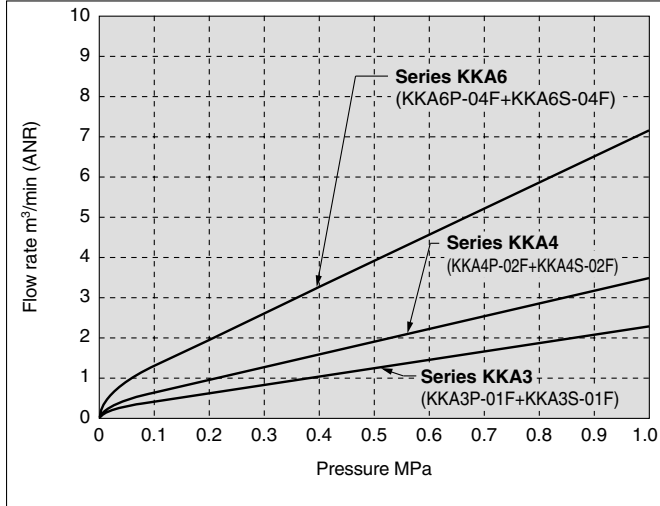

Plug: With check valve Socket: With check valve

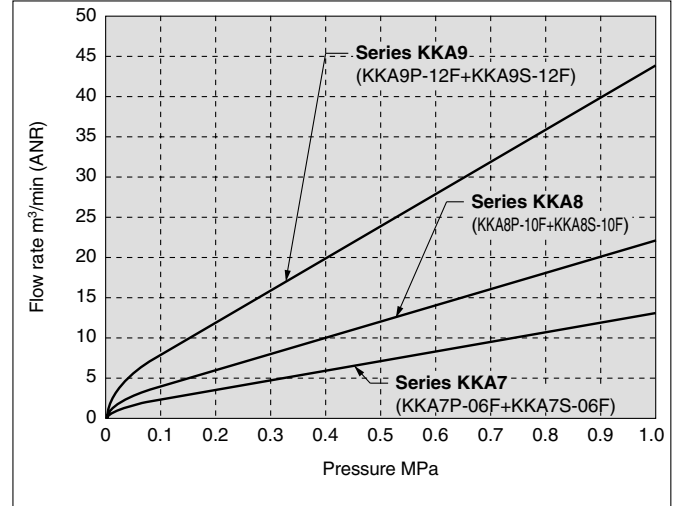

Plug: Without check valve Socket: With check valve

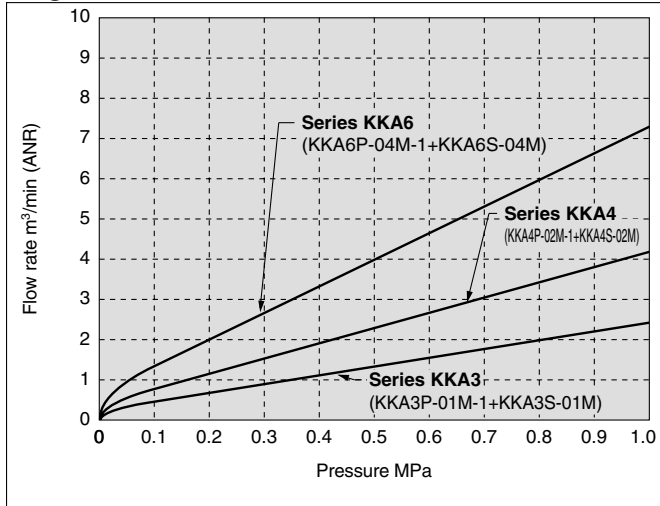

Plug: Without check valve Socket: Without check valve

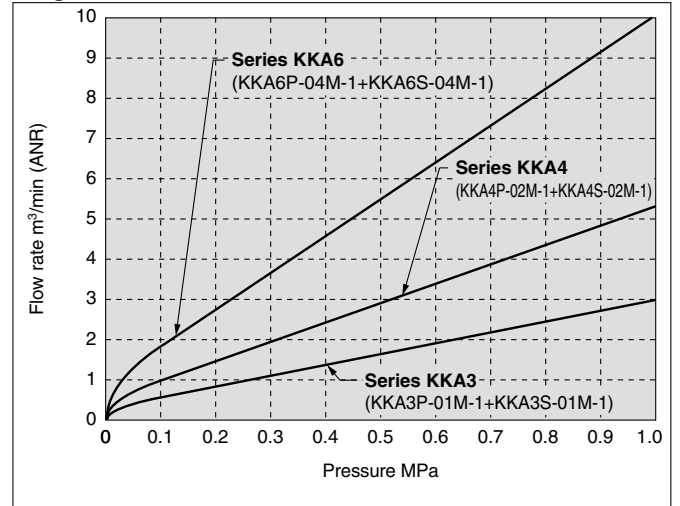

Pressure Loss

Water

Plug: With check valve Socket: With check valve

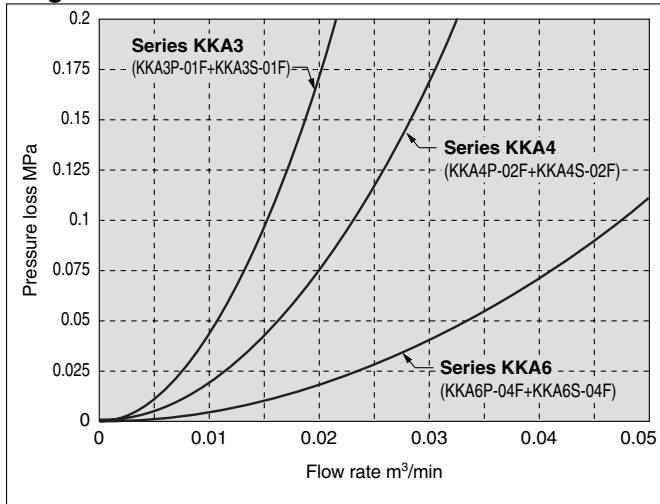

Plug: With check valve Socket: With check valve

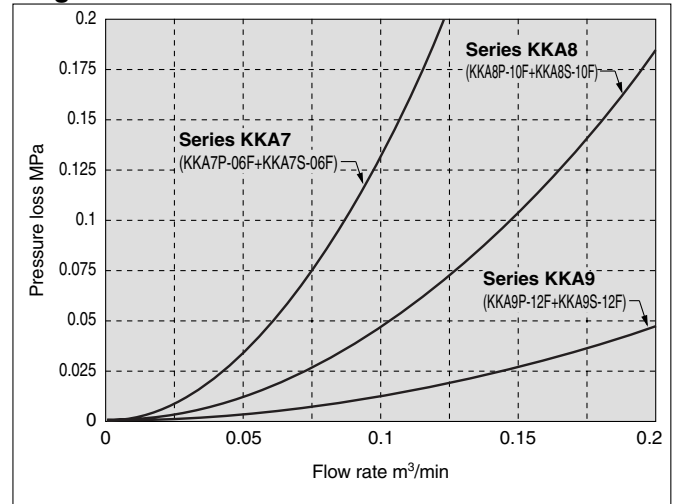

Construction

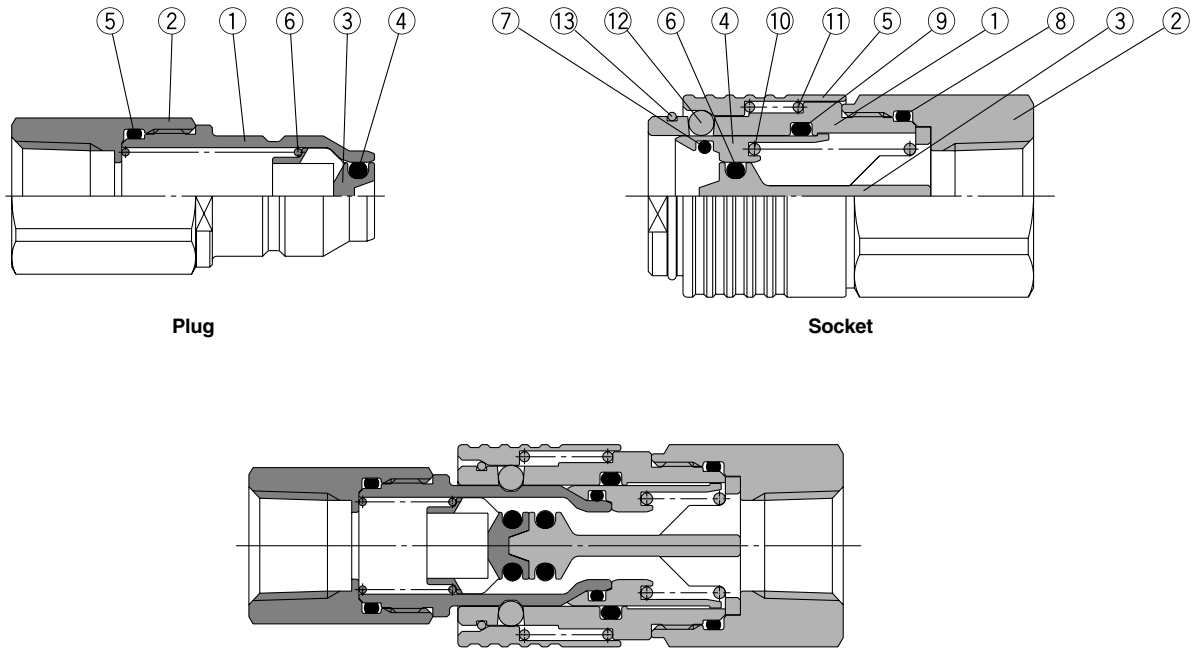

- K
- M
- H
- KKA
- D
- MS
- LQ
- MQR
- T

Plug

No.	Description	Material	Note
1	Stem	Stainless steel 304	Plated with fluorine-contained material
2	Rear stem	Stainless steel 304	
3	Plug valve	Stainless steel 304	
4	Valve O-ring	Special FKM	Fluorine coated
5	Stem O-ring	Special FKM	Fluorine coated
6	Plug valve spring	Stainless steel 304	

Socket

No.	Description	Material	Note
1	Body	Stainless steel 304	Plated with fluorine-contained material
2	Rear body	Stainless steel 304	
3	Socket valve	Stainless steel 304	
4	Collar	Stainless steel 304	Plated with fluorine-contained material
5	Sleeve	Stainless steel 304	Plated with fluorine-contained material
6	Valve O-ring	Special FKM	Fluorine coated
7	Plug O-ring	Special FKM	Fluorine coated
8	Body O-ring	Special FKM	Fluorine coated
9	Collar seal	Special FKM	Fluorine coated
10	Collar spring	Stainless steel 304	
11	Sleeve spring	Stainless steel 304	
12	Steel ball	Stainless steel 304	
13	Stopper ring	Stainless steel 304	

Series KKA Spare Parts

Description	Product no.	No.
Plug O-ring	KKA3S-P01	Socket ⑦
	KKA4S-P01	
	KKA6S-P01	
	KKA7S-P01	
	KKA8S-P01	
	KKA9S-P01	

Series KKA

Dimensions/Plug (P)

With check valve

Male thread type

(mm)



Body size	Model	T Connection port size	H Width across flats	L1	L2	A	Min. bore size	Effective area mm ²	Mass g
1/8	KKA3P-01M	R 1/8	14	35.4	16.0	31.4	5.6	17.4	15.4
	-02M	R 1/4		38.4		32.4			19.8
	-03M	R 3/8		39.4		32.9			32.9
1/4	KKA4P-02M	R 1/4	17	42.2	18.9	36.2	6.9	26.4	28.3
	-03M	R 3/8		43.2		36.7			36.6
	-04M	R 1/2	22	46.2		38.2			65.9
1/2	KKA6P-03M	R 3/8	24	47.1	20.4	40.6	10.0	54.2	60.3
	-04M	R 1/2		47.9		39.9			69.2
	-06M	R 3/4	30	49.9		40.4			119.0
3/4	KKA7P-04M	R 1/2	32	66.3	27.6	58.1	13.5	99.6	173.9
	-06M	R 3/4		69.4		59.9			209.6
	-10M	R 1	36	69.9		59.5			275.0
1	KKA8P-06M	R 3/4	41	82.9	35.6	73.4	17.5	168.3	362.8
	-10M	R 1		85.4		75.0			403.9
	-12M	R 1 1/4	46	85.4		72.7			538.6
1 1/4	KKA9P-10M	R 1	55	109.5	49.1	99.1	22.0	264.9	824.1
	-12M	R 1 1/4		109.0		96.3			861.4
	-14M	R 1 1/2		109.0		96.3	24.6	332.1	936.3

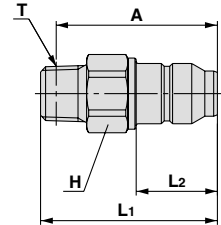

Female thread type

(mm)



Body size	Model	T Connection port size	H Width across flats	L1	L2	Min. bore size	Effective area mm ²	Mass g
1/8	KKA3P-01F	Rc 1/8	14	36.0	16.0	5.6	17.4	20.2
	-02F	Rc 1/4	17	39.6				31.8
	-03F	Rc 3/8	19	40.4				35.8
1/4	KKA4P-02F	Rc 1/4	17	43.4	18.9	6.9	26.4	36.1
	-03F	Rc 3/8	19	44.4				40.2
	-04F	Rc 1/2		48.6				69.7
1/2	KKA6P-03F	Rc 3/8	24	48.7	20.4	10.0	54.2	84.1
	-04F	Rc 1/2		52.9				79.7
	-06F	Rc 3/4	30	54.6				123.8
3/4	KKA7P-04F	Rc 1/2	32	67.7	27.6	13.5	99.6	217.1
	-06F	Rc 3/4		69.4				196.8
	-10F	Rc 1		72.4				325.9
1	KKA8P-06F	Rc 3/4	41	82.0	35.6	17.5	168.3	420.5
	-10F	Rc 1		85.0				391.3
	-12F	Rc 1 1/4	50	87.3				552.8
1 1/4	KKA9P-10F	Rc 1	55	107.8	49.1	24.6	332.1	986.9
	-12F	Rc 1 1/4		110.1				925.6
	-14F	Rc 1 1/2		110.1				848.2

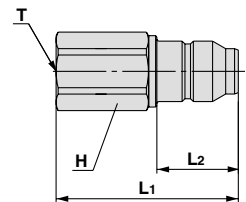

Dimensions/Socket (S)

With check valve

Male thread type

(mm)



Body size	Model	T Connection port size	H Width across flats	øD	L	A	Min. bore size	Effective area mm ²	Mass g
1/8	KKA3S-01M	R 1/8	17	18.5	38.1	34.1	5.9	18.5	38.5
	-02M	R 1/4			41.1	35.1			41.8
	-03M	R 3/8			42.1	35.6			46.3
1/4	KKA4S-02M	R 1/4	22	24.2	46.0	40.0	7.7	31.8	76.8
	-03M	R 3/8			47.0	40.5			78.5
	-04M	R 1/2			50.0	42.0			86.6
1/2	KKA6S-03M	R 3/8	30	30.7	51.4	44.9	10.2	55.3	149.1
	-04M	R 1/2			54.4	46.4			160.4
	-06M	R 3/4			56.4	46.9			184.8
3/4	KKA7S-04M	R 1/2	36	42.5	76.3	68.1	13.6	101.5	426.1
	-06M	R 3/4			79.3	69.8			457.8
	-10M	R 1			82.8	72.4			514.0
1	KKA8S-06M	R 3/4	46	55	94.9	85.4	17.6	169.9	873.5
	-10M	R 1			98.4	88.0			931.1
	-12M	R 1 1/4			100.4	87.7			1012.9
1 1/4	KKA9S-10M	R 1	63	69	125.5	115.1	25.1	344.9	1680.7
	-12M	R 1 1/4			127.5	114.8			1758.1
	-14M	R 1 1/2			127.5	114.8			1819.4

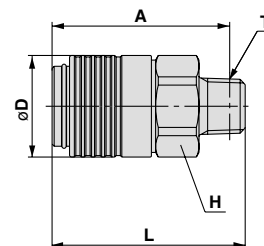

- K
- M
- H
- KK
- D
- MS
- LQ
- MQR
- T

Female thread type

(mm)



Body size	Model	T Connection port size	H Width across flats	øD	L	Min. bore size	Effective area mm ²	Mass g
1/8	KKA3S-01F	Rc 1/8	17	18.5	37.6	5.9	18.5	46.9
	-02F	Rc 1/4			41.2			47.2
	-03F	Rc 3/8			43.1			52.3
1/4	KKA4S-02F	Rc 1/4	22	24.2	46.1	7.7	31.8	97.1
	-03F	Rc 3/8			46.9			91.1
	-04F	Rc 1/2			52.3			104.3
1/2	KKA6S-03F	Rc 3/8	30	30.7	50.5	10.2	55.3	189.6
	-04F	Rc 1/2			56.2			202.0
	-06F	Rc 3/4			57.9			180.6
3/4	KKA7S-04F	Rc 1/2	36	42.5	75.1	13.6	101.5	477.2
	-06F	Rc 3/4			76.5			457.4
	-10F	Rc 1			82.3			550.9
1	KKA8S-06F	Rc 3/4	46	55	90.9	17.6	169.9	935.2
	-10F	Rc 1			93.9			914.7
	-12F	Rc 1 1/4			99.2			1002.1
1 1/4	KKA9S-10F	Rc 1	63	69	121.8	25.1	344.9	1919.1
	-12F	Rc 1 1/4			121.8			1810.0
	-14F	Rc 1 1/2			121.8			1732.6

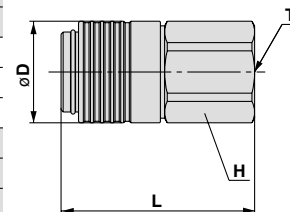

Series KKA

Dimensions/Plug (P)

Without check valve

Male thread type

(mm)



Body size	Model	T Connection port size	H Width across flats	L1	L2	A	Min. bore size	Effective area mm ²	Mass g
1/8	KKA3P-01M-1	R 1/8	12	28.5	16.0	24.5	6.0	22.6	9.8
	-02M-1	R 1/4	14	31.5		25.5			14.6
	-03M-1	R 3/8		32.5		26.0			23.6
1/4	KKA4P-02M-1	R 1/4	17	34.4	18.9	28.4	8.0	40.2	21.0
	-03M-1	R 3/8		35.4		28.9			27.9
	-04M-1	R 1/2		39.4		31.4			50.2
1/2	KKA6P-03M-1	R 3/8	22	37.9	20.4	31.4	11.0	76.0	41.9
	-04M-1	R 1/2	40.9	32.9		56.0			
	-06M-1	R 3/4	30	42.9		33.4			98.7

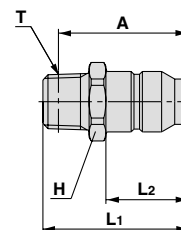

Female thread type

(mm)



Body size	Model	T Connection port size	H Width across flats	L1	L2	Min. bore size	Effective area mm ²	Mass g
1/8	KKA3P-01F-1	Rc 1/8	14	23.2	16.0	6.0	22.6	9.6
	-02F-1	Rc 1/4	17	30.3				20.2
	-03F-1	Rc 3/8	19	32.0				26.2
1/4	KKA4P-02F-1	Rc 1/4	17	29.7	18.9	8.0	40.2	20.0
	-03F-1	Rc 3/8	19	34.0				25.8
	-04F-1	Rc 1/2	24	39.4				46.1
1/2	KKA6P-03F-1	Rc 3/8	22	30.9	20.4	11.0	76.0	34.3
	-04F-1	Rc 1/2	24	39.6				50.0
	-06F-1	Rc 3/4	30	42.8				78.6

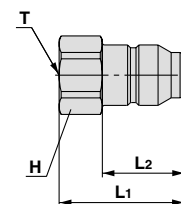

Dimensions/Socket (S)

Without check valve

Male thread type

(mm)



Body size	Model	T Connection port size	H Width across flats	øD	L	A	Min. bore size	Effective area mm ²	Mass g
1/8	KKA3S-01M-1	R 1/8	17	18.5	38.1	34.1	6.1	23.4	36.1
	-02M-1	R 1/4			41.1	35.1			39.4
	-03M-1	R 3/8			42.1	35.6			43.9
1/4	KKA4S-02M-1	R 1/4	22	24.2	46.0	40.0	8.1	41.2	71.9
	-03M-1	R 3/8			47.0	40.5			73.6
	-04M-1	R 1/2			50.0	42.0			81.7
1/2	KKA6S-03M-1	R 3/8	30	30.7	51.4	44.9	11.4	81.6	138.3
	-04M-1	R 1/2			54.4	46.4			149.6
	-06M-1	R 3/4			56.4	46.9			174.0

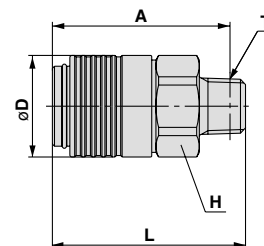

Female thread type

(mm)



Body size	Model	T Connection port size	H Width across flats	øD	L	Min. bore size	Effective area mm ²	Mass g
1/8	KKA3S-01F-1	Rc 1/8	17	18.5	37.6	6.1	23.4	44.5
	-02F-1	Rc 1/4			41.2			44.8
	-03F-1	Rc 3/8			43.1			49.9
1/4	KKA4S-02F-1	Rc 1/4	22	24.2	46.1	8.1	41.2	92.2
	-03F-1	Rc 3/8			46.9			86.2
	-04F-1	Rc 1/2			52.3			99.4
1/2	KKA6S-03F-1	Rc 3/8	30	30.7	50.5	11.4	81.6	178.8
	-04F-1	Rc 1/2			56.2			191.2
	-06F-1	Rc 3/4			57.9			169.8

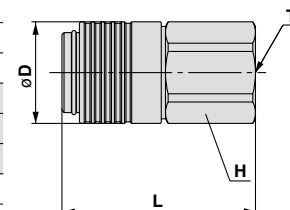

Series **KKA**

Made to Order Specifications



Please consult SMC for detailed specifications, dimensions and delivery.

1 Specifications without fluorine coating at the liquid-contact part Symbol
-X70

Ex.) KKA3S-01M-X70

• Without fluorine coating at the liquid contact part

- K
- M
- H
- KK**
- D
- MS
- LQ
- MQR
- T

Refer to pages 182 to 183 for Specific Product Precautions.