

HMIST6400

touch panel screen, Harmony ST6, 7inch wide display, 2COM, 2Ethernet, USB host and device, 24V DC



Main

Range of product	Harmony ST6
Product or component type	Touch panel screen
Processor name	ARM Cortex-A8

Complementary

Display size	7 inch
Display type	Colour TFT LCD
Display colour	16 million colours
Display resolution	800 x 480 pixels WVGA
Touch panel	Single touch analogue resistive
Backlight lifespan	50000 hours with white
Brightness	16 levels
Character font	ASCII ASCII (European characters) Chinese (simplified Chinese) Japanese (ANK, Kanji) Katakana Korean Taiwanese (traditional Chinese)
[Us] rated supply voltage	24 V DC (+/- 20 %)
Inrush current	30 A
Local signalling	Status LED green, steady for offline Status LED green, steady for operating Status LED green, flashing for operating Status LED green, faded for stand-by Status LED orange, flashing for software starting up Status LED red, steady for power supply (ON) Status LED red, flashing for operating Status LED red, off for power supply (OFF)
Power consumption in W	9 W
Number of pages	200 application pages
Software package	EcoStruxure Operator Terminal Expert
Processor frequency	800 MHz
Port Ethernet	10/100BASE
Memory description	1 GB device memory 128 MB user data memory 512 KB backup memory

The information provided in this documentation contains general descriptions and/or technical characteristics of the performance of the products contained herein. This documentation is not intended as a substitute for and is not to be used for determining suitability or reliability of these products for specific user applications. It is the duty of any such user or integrator to perform the appropriate and complete risk analysis, evaluation and testing of the products with respect to the relevant specific application or use thereof. Neither Schneider Electric Industries SAS nor any of its affiliates or subsidiaries shall be responsible or liable for misuse of the information contained herein.

Integrated connection type	1 COM1 serial link - 1 SUB-D 9-pin female - RS232C (rate: 2400...115200 bps)bottom 1 COM2 serial link - female RJ45 - RS485 (rate: 2400...115200 bps)back COM2 serial link (rate: 2400...187500 bps)back 1 USB 2.0 type Abottom 1 USB 2.0 type micro B 2 Ethernet
Supply	External supply
Realtime clock	Built-in 0...50 °C Built-in 10...90 % RH
Downloadable protocols	Modbus Uni-TE Third party protocols
Product brand	Schneider Electric Modicon Mitsubishi Melsec Omron Sysmac Rockwell Automation Allen-Bradley Siemens Simatic
Fixing mode	By 4 screws, mounting on 1.6...5 mm thick panel conforming to UL 61010-2-201 By 4 screws conforming to IEC 61131-2 By 4 screws conforming to IEC 61000-6-2
Enclosure material	PC
Front material	Aluminium
Marking	CE
Cut-out dimensions	190 x 135 mm panel cut dimension
Height	153 mm
Width	208 mm
Depth	45 mm
Net weight	0.8 kg

Environment

Immunity to microbreaks	5 ms
Standards	IEC 61000-6-4 IEC 61000-6-2 IEC 61131-2 UL 61010-2-201 CSA C22.2 No 61010-2-201
Product certifications	CSA[RETURN]CE[RETURN]UKCA
Directives	2014/35/EU - low voltage directive 2014/30/EU - electromagnetic compatibility
Ambient air temperature for operation	0...50 °C
Ambient air temperature for storage	-20...60 °C
Relative humidity	10...90 % non-condensing
Operating altitude	2000 m
IP degree of protection	IP20 (rear panel) conforming to IEC 61131-2 IP65 (front panel) conforming to IEC 61131-2
NEMA degree of protection	NEMA 4 front panel (indoor use) NEMA 13 front panel (in enclosure)
Shock resistance	147 m/s ² for 11 ms (X, Y, Z directions for 3 times) conforming to IEC 61131-2
Vibration resistance	+/- 3.5 mm (f = 5...9 Hz) X, Y, Z directions for 10 cycles (approx. 100 min) conforming to IEC 61131-2 9.8 m/s ² (f = 9...150 Hz)
Electromagnetic compatibility	Electrical fast transient/burst immunity test - test level: 2 kV (power ports) conforming to IEC 61000-4-4 Electrical fast transient/burst immunity test - test level: 1 kV (signal ports) Electrostatic discharge immunity test - test level: 6 kV (contact discharge) conforming to IEC 61000-4-2 level 3 Electrostatic discharge immunity test - test level: 8 kV (air discharge)

Packing Units

Unit Type of Package 1	PCE
Number of Units in Package 1	1
Package 1 Height	9.200 cm
Package 1 Width	17.500 cm
Package 1 Length	27.000 cm
Package 1 Weight	1.014 kg
Unit Type of Package 2	S03
Number of Units in Package 2	6
Package 2 Height	30.000 cm
Package 2 Width	30.000 cm
Package 2 Length	40.000 cm
Package 2 Weight	6.457 kg

Offer Sustainability

Sustainable offer status	Green Premium product
REACH Regulation	REACH Declaration
EU RoHS Directive	Pro-active compliance (Product out of EU RoHS legal scope)
China RoHS Regulation	China RoHS Declaration
RoHS exemption information	Yes
Environmental Disclosure	Product Environmental Profile
WEEE	The product must be disposed on European Union markets following specific waste collection and never end up in rubbish bins

Dimensions

External Dimensions

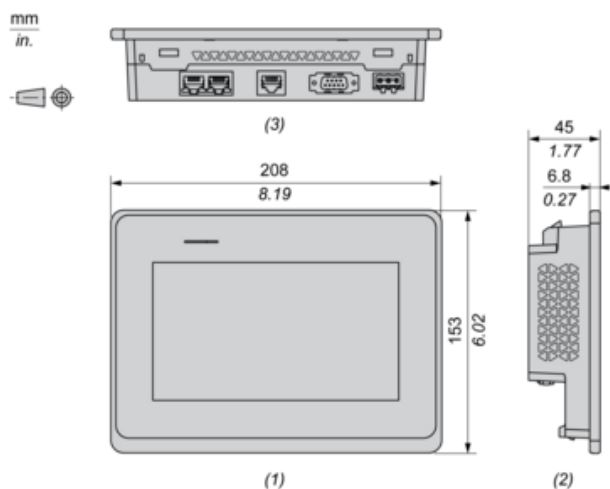

- (1) : Front
- (2) : Left
- (3) : Bottom

Dimensions with Installation Fasteners

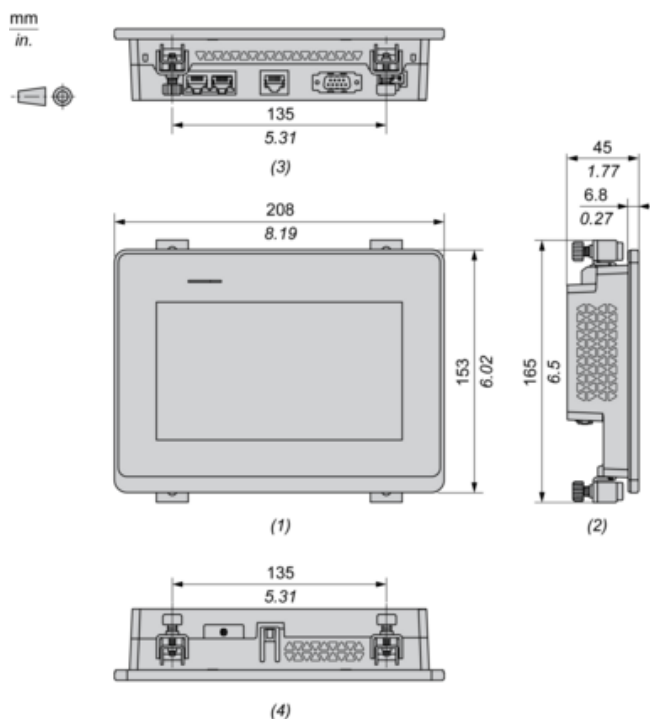

- (1) : Front
- (2) : Left
- (3) : Bottom
- (4) : Top

Dimensions with Cables

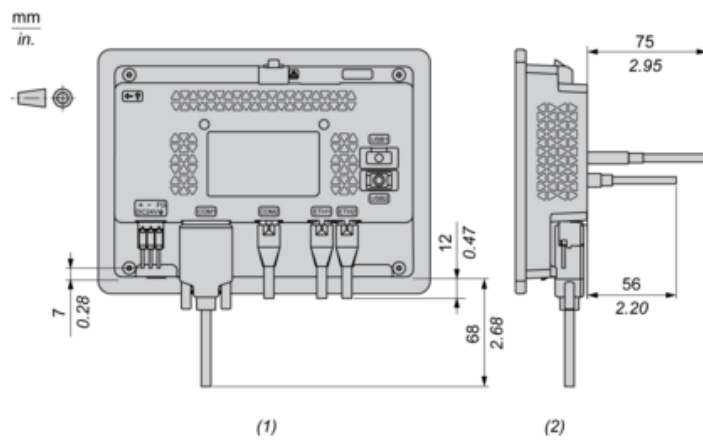

(1): Rear

(2): Right

Mounting

Panel Cut Dimensions

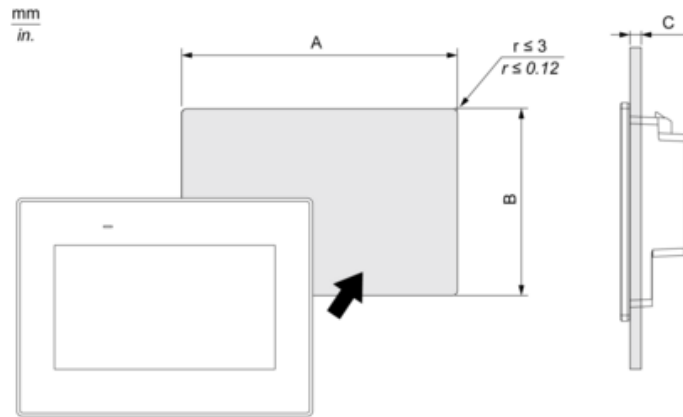

A		B		C	
mm	in.	mm	in.	mm	in.
190 (+1, -0)	7.48 (+0.04, -0)	135 (+1, -0)	5.31 (+0.04, -0)	1.6...5	0.06...0.2

Installation Requirements

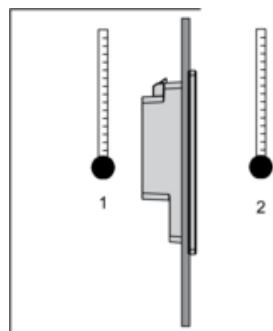

- 1: Internal temperature
- 2: External temperature

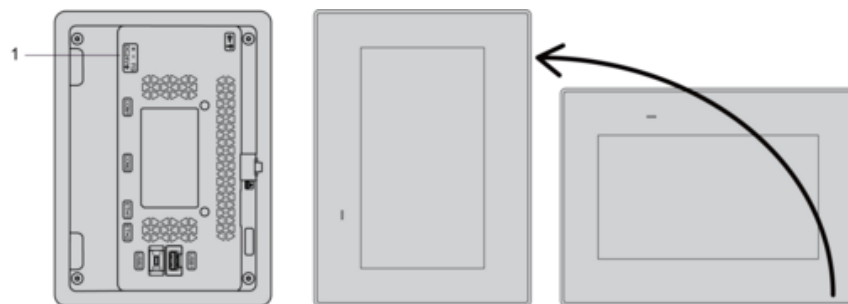

- 1: Power connector

Mounting Angle

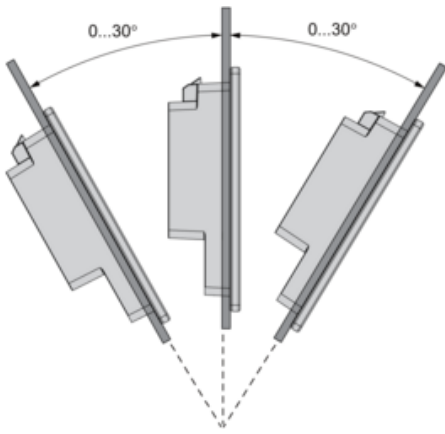

Clearance

