

Datasheet

Chassis Mount RCA Socket

RS Stock number [411-071](#)

Dimensions(mm):

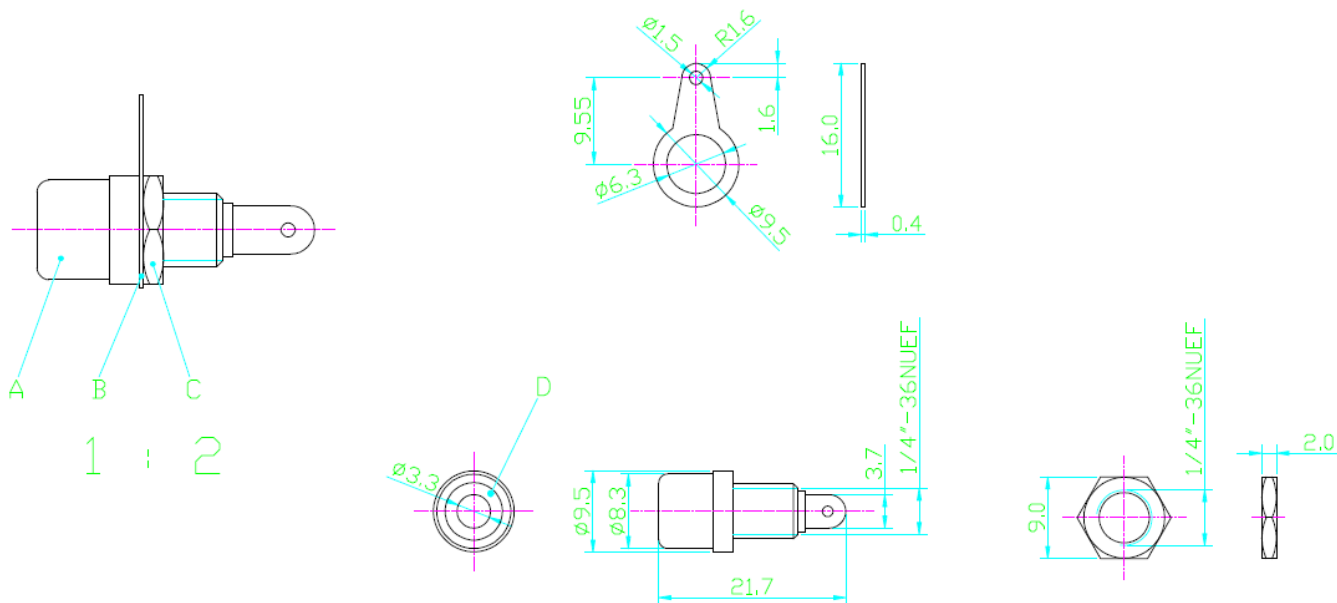

No.	Description	Unit	Material	Finish/Colour
A	Body	1	Brass	Nickel
B	Solder Piece	1	Iron	Nickel
C	Nut	1	Iron	Nickel
D	Insulator	1	Plastic	Red/Black