

Datasheet

RS Pro Clear Passivated, Zinc Steel Self-Clinching Nut, M4

RS Stock No: **827-631**



Product Details

RS Pro clinching nut has zinc plated stainless steel construction and is clear passivated for corrosion resistance. This nut is designed for quick installation using a simple press tool. The nut measures 2.4 mm deep with a fixing hole diameter of 5.4 mm. It has M4 threads for a cost-effective means of threaded nut placement in thin sheet metal applications.

Features and Benefits

- Case hardened mild steel, zinc plated and passivated to BS3382
- Self-clinching nuts should be assembled using a press tool or similar non-shock device
- Hank bushes can be either pressed into place or may be riveted by hand
- Unsuitable for use with sheet materials having a hardness of more than 80Rb



Specifications:

Body Depth	2.4 mm
Body Outside Diameter	7.9 mm
Finish	Zinc Plated, Clear Passivated
Fixing Hole Diameter	5.4 mm
Material	Steel
Thickness of Material Maximum	1.4 mm
Thickness of Material Minimum	1.1 mm
Thread Size	M4

DIMENSIONAL DATA

'PREFERRED' RANGES

The introduction of a range of 'Preferred' products, sizes and material enables designers to specify fasteners which show advantages in stock availability and cost.

'Preferred' sizes are indicated in the tables, by means of a heavy tint. Where design considerations dictate, specific product sizes or materials, are available to order. (See tables). Special variations possible on quotation.

'Preferred' Material Case Hardened Mild Steel for use in materials with hardness less than 80 R_B (150 V_{PN}). **(PS type).**

Other material — available to order — Stainless Steel BS 970.303 S21.

(PSS type).

'Preferred' Finish Zinc plated and clear passivated to BS 3382.

Other Finishes — available to order — Zinc and Chromate (ZC) Zinc and Black Passivate (ZB).

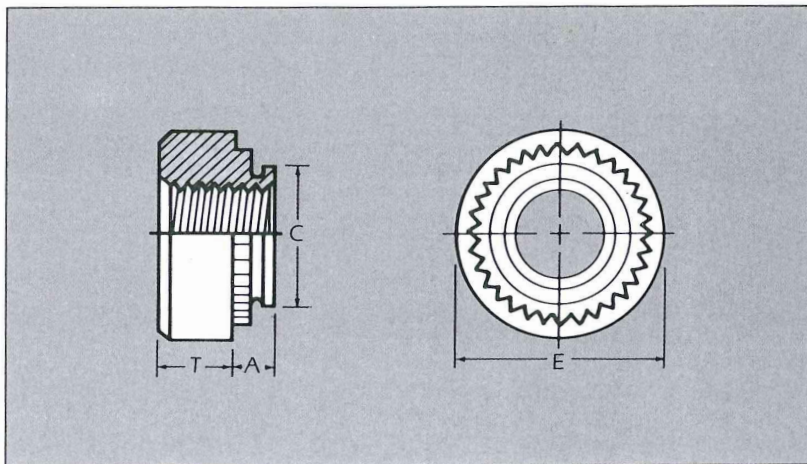

Thread Sizes			Shank No.	For Sheet Thickness	A Maximum	Hole size in sheet +0.075 -0.000	C Maximum	E Approx.	T	Minimum distance centre line hole to sheet edge
BA	UNC	ISO METRIC								
8	2	2	0	0.8-1.0	0.75	4.20	4.15	6.4	1.6	4.8
			1	1.1-1.4	1.05					
			2	1.5-2.3	1.45					
			3	2.4up	2.30					
6	4	2.5	0	0.8-1.0	0.75	4.20	4.15	6.4	1.6	4.8
			1	1.1-1.4	1.05					
			2	1.5-2.3	1.45					
			3	2.4up	2.30					
4	6	3	0	0.8-1.0	0.75	4.75	4.70	7.1	1.6	5.6
			1	1.1-1.4	1.05					
			2	1.5-2.3	1.45					
			3	2.4up	2.30					
—	—	3.5	0	0.8-1.0	0.75	4.75	4.70	7.1	1.6	5.6
			1	1.1-1.4	1.05					
			2	1.5-2.3	1.45					
			3	2.4up	2.30					
—	8	4	0	0.8-1.0	0.75	5.40	5.35	7.9	2.4	6.7
			1	1.1-1.4	1.05					
			2	1.5-2.3	1.45					
			3	2.4up	2.30					
2	10	5	0	0.8-1.0	0.75	6.35	6.30	8.7	2.4	7.0
			1	1.1-1.4	1.05					
			2	1.5-2.3	1.45					
			3	2.4up	2.30					
0	1/4	6	1	1.4-2.3	1.35	8.75	8.70	11.1	4.4	8.7
			2	2.4-3.2	2.30					
			3	3.3up	3.20					
			1	1.4-2.3	1.35					
—	5/16	8	2	2.4-3.2	2.30	10.50	10.45	12.7	6.0	9.5
			3	3.3up	3.20					
			1	2.3-3.2	2.20					
			2	3.3-6.3	3.10					
—	3/8	10	3	6.4up	6.00	12.70	12.65	14.3	6.7	11.0
			1	3.2-6.3	3.10					
			2	6.4up	6.00					
			1	3.2-6.3	3.10					
—	1/2	12	2	6.4up	6.00	16.65	16.60	20.6	9.1	16.0
			1	3.2-6.3	3.10					
			2	6.4up	6.00					
			1	3.2-6.3	3.10					

HOW TO SPECIFY

When specifying please state:

- 1 Product Name (PS)
- 2 Thread Size
- 3 Shank Number
- 4 Finish if other than 'Preferred'

Example: PS-M4-2

- 'PREFERRED' SIZES
- AVAILABLE TO ORDER ONLY
- POSSIBLE ON QUOTATION

	Shank No.	BA					UNIFIED COARSE					ISO METRIC															
		0	2	4	6	8	2	4	6	8	10	1/4	5/16	3/8	1/2	2	2.5	3	3.5	4	5	6	8	10	12		
STEEL	0																										
	1																										
	2																										
	3																										
STAINLESS STEEL	0																										
	1																										
	2																										
	3																										