

**Connector AM-TOP® - Part no. 550**

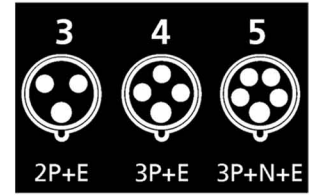

- screw terminals
- single part body
- cable gland and sealing
- strain relief and protection against kinking

Protection type	IP 67
Ampere	16A
Poles	5p
Voltage	400V
Hertz	50-60Hz
Earth position	6h
Contact	standard
Connection technology	Screw terminals

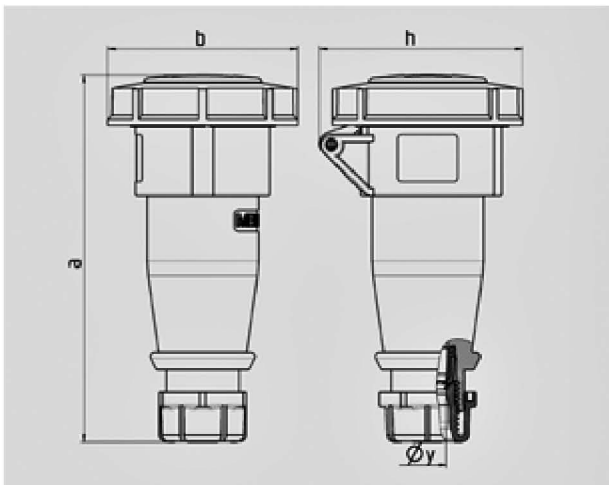

Drawing	Amp.	16			32		
		3	4	5	3	4	5
<b>3 MB 62</b>	<b>Poles</b>						
<b>Dim. in mm</b>	<b>a</b>	146	166	172	212	212	213
	<b>b</b>	72	79	89	96	96	102
	<b>h</b>	80	88	95	98	98	105
	<b>y</b>	14,5	16	16	22	22	22
<b>Terminal for cond. cross</b>		1	1	1	2,5	2,5	2,5
<b>section (mm²) min.-max.</b>		-2,5	-2,5	-2,5	-6	-6	-6

