

## 10 MHz to 12 GHz, 55 dB Logarithmic RF Power Detector

### FEATURES

- ▶ Complete RF detector function
- ▶ Wide operating frequency range from 10 MHz to 12 GHz
- ▶ Stable linear-in-decibel response
- ▶ 55 dB dynamic range ( $\pm 1$  dB error at 3.6 GHz RF input)
- ▶ Excellent temperature stability,  $\pm 1$  dB typical
- ▶ Positive/negative output slope response controlled by ENBL Pin
- ▶ Power on/off response time: 2.5  $\mu$ s/200 ns (rise/fall)
- ▶ Operates from  $-40^{\circ}\text{C}$  to  $+105^{\circ}\text{C}$
- ▶ Low power: 12.5 mA at 3.3 V
- ▶ Disable current  $< 100$   $\mu$ A
- ▶ Power supply voltage range from 2.7 V to 3.45 V

### APPLICATIONS

- ▶ RSSI and TSSI for wired and wireless terminal devices
- ▶ RF transmitter or receiver power measurement
- ▶ Wide-band Automatic Gain Control

### GENERAL DESCRIPTION

The **ADL5507** is a complete, low-power, wide-band logarithmic RF power detector for the measurement of RF signals in the 10 MHz to 12 GHz frequency range. The device is optimized for accurate RF signal level measurements over a 55 dB dynamic range, from  $-56$  dBm to  $-1$  dBm at 3.6 GHz, when terminated with  $50\ \Omega$ . It provides a wider dynamic range and better accuracy than is possible using discrete diode detectors. Its high sensitivity allows measurement of low power levels, thus reducing the amount of power that needs to be coupled to the detector.

For convenience, the signal input is internally AC-coupled, using a series 25 pF capacitor. Therefore, the source can be DC grounded. A broadband  $50\ \Omega$  match is obtained with an external  $51\ \Omega$  shunt resistor. This high-pass coupling, with a corner at approximately 4 MHz, determines the lowest operating frequency.

The DC voltage at the ADL5507 output interface responds linear-in-dB to the RF signal level applied at its input. It is accurately temperature compensated to provide typically better than  $\pm 1$  dB measurement accuracy over the full case operating temperature range from  $-40^{\circ}\text{C}$  to  $+105^{\circ}\text{C}$ . The output interface has sufficient capability to drive a wide range of analog-to-digital converters (ADCs) and other circuitry.

The CFLT interface enables additional ripple and noise filtering of the output signal, without reducing the drive capability of the VLOG interface. This is achieved by connecting a capacitor between the CFLT and VLOG interfaces.

The tri-state ENBL interface switches the device between active positive output slope mode, active negative output slope mode, and a low-power shutdown mode. In positive output slope mode, the ADL5507 output increases approximately from 0.1 V to 1.2 V as the input signal level increases from 0.35 mV rms ( $-56$  dBm) to 200 mV rms ( $-1$  dBm). In negative output slope mode, the output decreases approximately from 1 V to 0 V as the input signal level decreases from 200 mV rms ( $-1$  dBm) to 0.35 mV rms ( $-56$  dBm). The output interface becomes high impedance in shutdown to avoid discharge of external filter capacitors.

The ADL5507 is available in a 6-ball WLCSP package and consumes 12.5 mA from a 3.3 V supply. In shutdown mode, the typical disable supply current is  $< 100\ \mu\text{A}$ .

### FUNCTIONAL BLOCK DIAGRAM

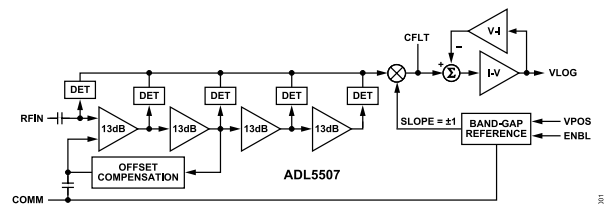

Figure 1. Functional Block Diagram

Rev. 0

DOCUMENT FEEDBACK

TECHNICAL SUPPORT

Information furnished by Analog Devices is believed to be accurate and reliable "as is". However, no responsibility is assumed by Analog Devices for its use, nor for any infringements of patents or other rights of third parties that may result from its use. Specifications subject to change without notice. No license is granted by implication or otherwise under any patent or patent rights of Analog Devices. Trademarks and registered trademarks are the property of their respective owners.

**TABLE OF CONTENTS**

Features.....	1	Log Conformance Error Calculation.....	29
Applications.....	1	Input Coupling Options.....	30
General Description.....	1	Filter Capacitor.....	31
Functional Block Diagram.....	1	VLOG Pulse Response Time.....	31
Specifications.....	3	VLOG Output Noise.....	31
Absolute Maximum Ratings.....	12	Effect of Waveform Type on Intercept.....	31
ESD Caution.....	12	Device Handling.....	31
Pin Configuration and Function Descriptions.....	13	Evaluation Board.....	32
Typical Performance Characteristics.....	14	Land Pattern and Soldering Information.....	32
Measurement Setups.....	27	Outline Dimensions.....	34
Theory of Operation.....	28	Ordering Guide.....	34
Applications Information.....	29	Evaluation Boards.....	34
Basic Connections.....	29		
Transfer Function in Terms of Slope and Intercept .....	29		

**REVISION HISTORY****12/2023—Revision 0: Initial Version**

## SPECIFICATIONS

VPOS = 3.3 V,  $T_A = 25^\circ\text{C}$ , 50  $\Omega$  source at RFIN,  $f_{\text{RF}} = 3.6$  GHz, CW signal, unless otherwise noted. Test circuit as shown in Figure 87.

Table 1. Specifications

Parameter	Test Conditions/Comments	Min	Typ	Max	Unit
<b>SIGNAL INPUT INTERFACE</b>					
	Pin RFIN				
Frequency Range			10 to 12000		MHz
Input Voltage Range	Internally ac-coupled, $\pm 1$ dB Logarithmic Conformance		0.35 to 200		mV rms
Equivalent Power Range	51 $\Omega$ external termination		-56 to -1		dBm
Input Resistance	$f = 0.1$ GHz, 51 $\Omega$ shunt resistor at RFIN		50		$\Omega$
<b>OUTPUT INTERFACE</b>					
	Pin VLOG				
Output Offset Voltage	No signal at RFIN, $R_L \geq 10$ k $\Omega$ + Slope mode (ENBL = VPOS) - Slope mode (ENBL = VPOS/2)		0.10 1.05		V V
Maximum Output Voltage	Transient during enable sequencing		1.2		V
Available Output Current	Sourcing/sinking		15/15		mA
Rise Time	$R_{\text{LOAD}} = 100$ $\Omega$ , output level 10% to 90% of steady state value + Slope mode (ENBL = VPOS), $P_{\text{RFIN}} = \text{off}$ to -25 dBm - Slope mode (ENBL = VPOS/2), $P_{\text{RFIN}} = -25$ dBm to off		200 300		ns ns
Fall Time	$R_{\text{LOAD}} = 100$ $\Omega$ , output level 90% to 10% of steady state value + Slope mode (ENBL = VPOS), $P_{\text{RFIN}} = -25$ dBm to off - Slope mode (ENBL = VPOS/2), $P_{\text{RFIN}} = \text{off}$ to -25 dBm		200 300		ns ns
Output Noise Spectral Density	Measured at 100 kHz, -25 dBm at RFIN + Slope mode (ENBL = VPOS) - Slope mode (ENBL = VPOS/2)		270 570		nV/ $\sqrt{\text{Hz}}$ nV/ $\sqrt{\text{Hz}}$
<b>ENABLE INTERFACE</b>					
	Pin ENBL				
Input High Voltage (On, + Slope Mode)	ENBL = High, $-40^\circ\text{C} \leq T_A \leq +105^\circ\text{C}$	0.8·VPOS		VPOS	V
Input Current When High	ENBL = 3.3V, $-40^\circ\text{C} \leq T_A \leq +105^\circ\text{C}$		<1		$\mu\text{A}$
Input Open Circuit Voltage (On, - Slope Mode)	ENBL = Open, $-40^\circ\text{C} \leq T_A \leq +105^\circ\text{C}$	0.4·VPOS	VPOS/2	0.6·VPOS	V
Input Low Voltage (Shutdown)	ENBL = Low, $-40^\circ\text{C} \leq T_A \leq +105^\circ\text{C}$	0		0.2·VPOS	V
<b>POWER INTERFACE</b>					
	Pin VPOS				
Supply Voltage		2.7	3.3	3.45	V
Supply Current (On, + Slope Mode)	ENBL = VPOS		12.5		mA
Supply Current (On, - Slope Mode)	ENBL = VPOS/2		12.5		mA
Shutdown Current	ENBL = 0 V		<100		$\mu\text{A}$
<b>DETECTOR RESPONSE, POSITIVE SLOPE MODE</b>					
	Pin VLOG				
+ Slope Mode, 10 MHz	ENBL = VPOS				

## SPECIFICATIONS

Table 1. Specifications (Continued)

Parameter	Test Conditions/Comments	Min	Typ	Max	Unit
±1.0 dB Error Dynamic Range			51.7		dB
Maximum Input Level, ±1.0 dB Error			-0.1		dBm
Minimum Input Level, ±1.0 dB Error			-51.8		dBm
Temperature Drift Error	Log conformance error deviation from 25°C -40°C < T <sub>A</sub> < +105°C, P <sub>RFIN</sub> = -45 dBm		+0.54/-0.09 <sup>1</sup>		dB
	-40°C < T <sub>A</sub> < +105°C, P <sub>RFIN</sub> = -10 dBm		+0.78/-0.46 <sup>1</sup>		dB
Logarithmic Slope	Linear regression from -45 dBm to -10 dBm		18.4		mV/dB
Logarithmic Intercept	Linear regression from -45 dBm to -10 dBm		-60.9		dBm
Output Voltage-High Power Input	P <sub>RFIN</sub> = -5 dBm		1022		mV
Output Voltage-Low Power Input	P <sub>RFIN</sub> = -50 dBm		211		mV
+ Slope Mode, 100 MHz	ENBL = VPOS				
±1.0 dB Error Dynamic Range			51.5		dB
Maximum Input Level, ±1.0 dB Error			-1.0		dBm
Minimum Input Level, ±1.0 dB Error			-52.5		dBm
Temperature Drift Error	Log conformance error deviation from 25°C -40°C < T <sub>A</sub> < +105°C, P <sub>RFIN</sub> = -45 dBm		+0.26/+0.20 <sup>1</sup>		dB
	-40°C < T <sub>A</sub> < +105°C, P <sub>RFIN</sub> = -10 dBm		+0.66/-0.30 <sup>1</sup>		dB
Logarithmic Slope	Linear regression from -45 dBm to -10 dBm		18.6		mV/dB
Logarithmic Intercept	Linear regression from -45 dBm to -10 dBm		-62.0		dBm
Output Voltage-High Power Input	P <sub>RFIN</sub> = -5 dBm		1058		mV
Output Voltage-Low Power Input	P <sub>RFIN</sub> = -50 dBm		234		mV
+ Slope Mode, 450 MHz	ENBL = VPOS				
±1.0 dB Error Dynamic Range			52.1		dB
Maximum Input Level, ±1.0 dB Error			-1.1		dBm
Minimum Input Level, ±1.0 dB Error			-53.3		dBm
Temperature Drift Error	Log conformance error deviation from 25°C -40°C < T <sub>A</sub> < +105°C, P <sub>RFIN</sub> = -45 dBm		+0.19/+0.25 <sup>1</sup>		dB
	-40°C < T <sub>A</sub> < +105°C, P <sub>RFIN</sub> = -10 dBm		+0.63/-0.27 <sup>1</sup>		dB
Logarithmic Slope	Linear regression from -45 dBm to -10 dBm		18.7		mV/dB
Logarithmic Intercept	Linear regression from -45 dBm to -10 dBm		-62.3		dBm
Output Voltage-High Power Input	P <sub>RFIN</sub> = -5 dBm		1069		mV

## SPECIFICATIONS

Table 1. Specifications (Continued)

Parameter	Test Conditions/Comments	Min	Typ	Max	Unit
Output Voltage-Low Power Input	$P_{RFIN} = -50$ dBm		239		mV
+ Slope Mode, 700 MHz	ENBL = VPOS				
±1.0 dB Error Dynamic Range			52.7		dB
Maximum Input Level, ±1.0 dB Error			-1.0		dBm
Minimum Input Level, ±1.0 dB Error			-53.8		dBm
Temperature Drift Error	Log conformance error deviation from 25°C -40°C < $T_A$ < +105°C, $P_{RFIN} = -45$ dBm		+0.22/+0.25 <sup>1</sup>		dB
	-40°C < $T_A$ < +105°C, $P_{RFIN} = -10$ dBm		+0.64/-0.26 <sup>1</sup>		dB
Logarithmic Slope	Linear regression from -45 dBm to -10 dBm		18.7		mV/dB
Logarithmic Intercept	Linear regression from -45 dBm to -10 dBm		-62.5		dBm
Output Voltage-High Power Input	$P_{RFIN} = -5$ dBm		1073		mV
Output Voltage-Low Power Input	$P_{RFIN} = -50$ dBm		240		mV
+ Slope Mode, 2.4 GHz	ENBL = VPOS				
±1.0 dB Error Dynamic Range			54.9		dB
Maximum Input Level, ±1.0 dB Error			-0.7		dBm
Minimum Input Level, ±1.0 dB Error			-55.7		dBm
Temperature Drift Error	Log conformance error deviation from 25°C -40°C < $T_A$ < +105°C, $P_{RFIN} = -45$ dBm		+0.29/+0.18 <sup>1</sup>		dB
	-40°C < $T_A$ < +105°C, $P_{RFIN} = -10$ dBm		+0.61/-0.27 <sup>1</sup>		dB
Logarithmic Slope	Linear regression from -45 dBm to -10 dBm		18.7		mV/dB
Logarithmic Intercept	Linear regression from -45 dBm to -10 dBm		-63.6		dBm
Output Voltage-High Power Input	$P_{RFIN} = -5$ dBm		1094		mV
Output Voltage-Low Power Input	$P_{RFIN} = -50$ dBm		257		mV
+ Slope Mode, 3.6 GHz	ENBL = VPOS				
±1.0 dB Error Dynamic Range			55.0		dB
Maximum Input Level, ±1.0 dB Error			-1.2		dBm
Minimum Input Level, ±1.0 dB Error			-56.2		dBm
Temperature Drift Error	Log conformance error deviation from 25°C -40°C < $T_A$ < +105°C, $P_{RFIN} = -45$ dBm		+0.37/+0.14 <sup>1</sup>		dB
	-40°C < $T_A$ < +105°C, $P_{RFIN} = -10$ dBm		+0.69/-0.28 <sup>1</sup>		dB
Logarithmic Slope	Linear regression from -45 dBm to -10 dBm		18.7		mV/dB
Logarithmic Intercept	Linear regression from -45 dBm to -10 dBm		-64.4		dBm

## SPECIFICATIONS

Table 1. Specifications (Continued)

Parameter	Test Conditions/Comments	Min	Typ	Max	Unit
Output Voltage-High Power Input	$P_{RFIN} = -5$ dBm		1109		mV
Output Voltage-Low Power Input	$P_{RFIN} = -50$ dBm		269		mV
+ Slope Mode, 5.8 GHz	ENBL = VPOS				
±1.0 dB Error Dynamic Range			55.3		dB
Maximum Input Level, ±1.0 dB Error			-1.6		dBm
Minimum Input Level, ±1.0 dB Error			-56.9		dBm
Temperature Drift Error	Log conformance error deviation from 25°C				
	-40°C < $T_A$ < +105°C, $P_{RFIN} = -45$ dBm		+0.40/+0.01 <sup>1</sup>		dB
	-40°C < $T_A$ < +105°C, $P_{RFIN} = -10$ dBm		+0.91/-0.42 <sup>1</sup>		dB
Logarithmic Slope	Linear regression from -45 dBm to -10 dBm		18.7		mV/dB
Logarithmic Intercept	Linear regression from -45 dBm to -10 dBm		-64.7		dBm
Output Voltage-High Power Input	$P_{RFIN} = -5$ dBm		1119		mV
Output Voltage-Low Power Input	$P_{RFIN} = -50$ dBm		275		mV
+ Slope Mode, 8 GHz	ENBL = VPOS				
±1.0 dB Error Dynamic Range			51.5		dB
Maximum Input Level, ±1.0 dB Error			-4.3		dBm
Minimum Input Level, ±1.0 dB Error			-55.8		dBm
Temperature Drift Error	Log conformance error deviation from 25°C				
	-40°C < $T_A$ < +105°C, $P_{RFIN} = -45$ dBm		+0.36/-0.19 <sup>1</sup>		dB
	-40°C < $T_A$ < +105°C, $P_{RFIN} = -10$ dBm		+0.98/-0.78 <sup>1</sup>		dB
Logarithmic Slope	Linear regression from -45 dBm to -10 dBm		19.0		mV/dB
Logarithmic Intercept	Linear regression from -45 dBm to -10 dBm		-66.0		dBm
Output Voltage-High Power Input	$P_{RFIN} = -5$ dBm		1151		mV
Output Voltage-Low Power Input	$P_{RFIN} = -50$ dBm		306		mV
+ Slope Mode, 10 GHz	ENBL = VPOS				
±1.0 dB Error Dynamic Range			50.9		dB
Maximum Input Level, ±1.0 dB Error			-4.6		dBm
Minimum Input Level, ±1.0 dB Error			-55.5		dBm
Temperature Drift Error	Log conformance error deviation from 25°C				
	-40°C < $T_A$ < +105°C, $P_{RFIN} = -45$ dBm		+0.42/+0.08 <sup>1</sup>		dB
	-40°C < $T_A$ < +105°C, $P_{RFIN} = -10$ dBm		+1.03/-0.48 <sup>1</sup>		dB

## SPECIFICATIONS

Table 1. Specifications (Continued)

Parameter	Test Conditions/Comments	Min	Typ	Max	Unit
Logarithmic Slope	Linear regression from -45 dBm to -10 dBm		19.3		mV/dB
Logarithmic Intercept	Linear regression from -45 dBm to -10 dBm		-64.7		dBm
Output Voltage-High Power Input	$P_{RFIN} = -5$ dBm		1139		mV
Output Voltage-Low Power Input	$P_{RFIN} = -50$ dBm		287		mV
+ Slope Mode, 12 GHz	ENBL = VPOS				
±1.0 dB Error Dynamic Range			48.8		dB
Maximum Input Level, ±1.0 dB Error			-1.3		dBm
Minimum Input Level, ±1.0 dB Error			-50.0		dBm
Temperature Drift Error	Log conformance error deviation from 25°C -40°C < T <sub>A</sub> < +105°C, P <sub>RFIN</sub> = -45 dBm		+0.65/-0.18 <sup>1</sup>		dB
	-40°C < T <sub>A</sub> < +105°C, P <sub>RFIN</sub> = -10 dBm		+1.38/-0.76 <sup>1</sup>		dB
Logarithmic Slope	Linear regression from -45 dBm to -10 dBm		19.7		mV/dB
Logarithmic Intercept	Linear regression from -45 dBm to -10 dBm		-58.9		dBm
Output Voltage-High Power Input	$P_{RFIN} = -5$ dBm		1068		mV
Output Voltage-Low Power Input	$P_{RFIN} = -50$ dBm		195		mV
DETECTOR RESPONSE, NEGATIVE SLOPE MODE	Pin VLOG				
- Slope Mode, 10 MHz	ENBL = VPOS/2				
±1.0 dB Error Dynamic Range			51.6		dB
Maximum Input Level, ±1.0 dB Error			-0.1		dBm
Minimum Input Level, ±1.0 dB Error			-51.7		dBm
Temperature Drift Error	Log conformance error deviation from 25°C -40°C < T <sub>A</sub> < +105°C, P <sub>RFIN</sub> = -45 dBm		-0.28/-0.12 <sup>1</sup>		dB
	-40°C < T <sub>A</sub> < +105°C, P <sub>RFIN</sub> = -10 dBm		-0.50/+0.23 <sup>1</sup>		dB
Logarithmic Slope	Linear regression from -45 dBm to -10 dBm		-18.3		mV/dB
Logarithmic Intercept	Linear regression from -45 dBm to -10 dBm		0.5		dBm
Output Voltage-High Power Input	$P_{RFIN} = -5$ dBm		105		mV
Output Voltage-Low Power Input	$P_{RFIN} = -50$ dBm		914		mV
- Slope Mode, 100 MHz	ENBL = VPOS/2				
±1.0 dB Error Dynamic Range			51.6		dB
Maximum Input Level, ±1.0 dB Error			-1.0		dBm

## SPECIFICATIONS

Table 1. Specifications (Continued)

Parameter	Test Conditions/Comments	Min	Typ	Max	Unit
Minimum Input Level, $\pm 1.0$ dB Error			-52.6		dBm
Temperature Drift Error	Log conformance error deviation from 25°C -40°C < T <sub>A</sub> < +105°C, P <sub>RFIN</sub> = -45 dBm -40°C < T <sub>A</sub> < +105°C, P <sub>RFIN</sub> = -10 dBm		+0.01/-0.41 <sup>1</sup> -0.42/+0.06 <sup>1</sup>		dB dB
Logarithmic Slope	Linear regression from -45 dBm to -10 dBm		-18.6		mV/dB
Logarithmic Intercept	Linear regression from -45 dBm to -10 dBm		-1.4		dBm
Output Voltage-High Power Input	P <sub>RFIN</sub> = -5 dBm		69		mV
Output Voltage-Low Power Input	P <sub>RFIN</sub> = -50 dBm		891		mV
- Slope Mode, 450 MHz $\pm 1.0$ dB Error Dynamic Range	ENBL = VPOS/2		51.7		dB
Maximum Input Level, $\pm 1.0$ dB Error			-1.5		dBm
Minimum Input Level, $\pm 1.0$ dB Error			-53.2		dBm
Temperature Drift Error	Log conformance error deviation from 25°C -40°C < T <sub>A</sub> < +105°C, P <sub>RFIN</sub> = -45 dBm -40°C < T <sub>A</sub> < +105°C, P <sub>RFIN</sub> = -10 dBm		+0.03/-0.49 <sup>1</sup> -0.38/+0.04 <sup>1</sup>		dB dB
Logarithmic Slope	Linear regression from -45 dBm to -10 dBm		-18.7		mV/dB
Logarithmic Intercept	Linear regression from -45 dBm to -10 dBm		-2.1		dBm
Output Voltage-High Power Input	P <sub>RFIN</sub> = -5 dBm		58		mV
Output Voltage-Low Power Input	P <sub>RFIN</sub> = -50 dBm		887		mV
- Slope Mode, 700 MHz $\pm 1.0$ dB Error Dynamic Range	ENBL = VPOS/2		52.2		dB
Maximum Input Level, $\pm 1.0$ dB Error			-1.6		dBm
Minimum Input Level, $\pm 1.0$ dB Error			-53.8		dBm
Temperature Drift Error	Log conformance error deviation from 25°C -40°C < T <sub>A</sub> < +105°C, P <sub>RFIN</sub> = -45 dBm -40°C < T <sub>A</sub> < +105°C, P <sub>RFIN</sub> = -10 dBm		+0.03/-0.48 <sup>1</sup> -0.39/+0.03 <sup>1</sup>		dB dB
Logarithmic Slope	Linear regression from -45 dBm to -10 dBm		-18.7		mV/dB
Logarithmic Intercept	Linear regression from -45 dBm to -10 dBm		-2.3		dBm
Output Voltage-High Power Input	P <sub>RFIN</sub> = -5 dBm		54		mV
Output Voltage-Low Power Input	P <sub>RFIN</sub> = -50 dBm		885		mV
- Slope Mode, 2.4 GHz $\pm 1.0$ dB Error Dynamic Range	ENBL = VPOS/2		53.2		dB



## SPECIFICATIONS

Table 1. Specifications (Continued)

Parameter	Test Conditions/Comments	Min	Typ	Max	Unit
Maximum Input Level, $\pm 1.0$ dB Error			-2.5		dBm
Minimum Input Level, $\pm 1.0$ dB Error			-55.7		dBm
Temperature Drift Error	Log conformance error deviation from 25°C -40°C < T <sub>A</sub> < +105°C, P <sub>RFIN</sub> = -45 dBm -40°C < T <sub>A</sub> < +105°C, P <sub>RFIN</sub> = -10 dBm		-0.08/-0.42 <sup>1</sup> -0.39/+0.05 <sup>1</sup>		dB dB
Logarithmic Slope	Linear regression from -45 dBm to -10 dBm		-18.7		mV/dB
Logarithmic Intercept	Linear regression from -45 dBm to -10 dBm		-3.4		dBm
Output Voltage-High Power Input	P <sub>RFIN</sub> = -5 dBm		33		mV
Output Voltage-Low Power Input	P <sub>RFIN</sub> = -50 dBm		868		mV
- Slope Mode, 3.6 GHz $\pm 1.0$ dB Error Dynamic Range	ENBL = VPOS/2		51.3		dB
Maximum Input Level, $\pm 1.0$ dB Error			-5.0		dBm
Minimum Input Level, $\pm 1.0$ dB Error			-56.3		dBm
Temperature Drift Error	Log conformance error deviation from 25°C -40°C < T <sub>A</sub> < +105°C, P <sub>RFIN</sub> = -45 dBm -40°C < T <sub>A</sub> < +105°C, P <sub>RFIN</sub> = -10 dBm		-0.14/-0.37 <sup>1</sup> -0.43/+0.07 <sup>1</sup>		dB dB
Logarithmic Slope	Linear regression from -45 dBm to -10 dBm		-18.7		mV/dB
Logarithmic Intercept	Linear regression from -45 dBm to -10 dBm		-4.1		dBm
Output Voltage-High Power Input	P <sub>RFIN</sub> = -5 dBm		18		mV
Output Voltage-Low Power Input	P <sub>RFIN</sub> = -50 dBm		857		mV
- Slope Mode, 5.8 GHz $\pm 1.0$ dB Error Dynamic Range	ENBL = VPOS/2		53.6		dB
Maximum Input Level, $\pm 1.0$ dB Error			-3.3		dBm
Minimum Input Level, $\pm 1.0$ dB Error			-56.9		dBm
Temperature Drift Error	Log conformance error deviation from 25°C -40°C < T <sub>A</sub> < +105°C, P <sub>RFIN</sub> = -45 dBm -40°C < T <sub>A</sub> < +105°C, P <sub>RFIN</sub> = -10 dBm		-0.17/-0.24 <sup>1</sup> -0.66/+0.22 <sup>1</sup>		dB dB
Logarithmic Slope	Linear regression from -45 dBm to -10 dBm		-18.6		mV/dB
Logarithmic Intercept	Linear regression from -45 dBm to -10 dBm		-4.2		dBm
Output Voltage-High Power Input	P <sub>RFIN</sub> = -5 dBm		11		mV
Output Voltage-Low Power Input	P <sub>RFIN</sub> = -50 dBm		853		mV
- Slope Mode, 8 GHz	ENBL = VPOS/2				

## SPECIFICATIONS

Table 1. Specifications (Continued)

Parameter	Test Conditions/Comments	Min	Typ	Max	Unit
±1.0 dB Error Dynamic Range			50.0		dB
Maximum Input Level, ±1.0 dB Error			-5.9		dBm
Minimum Input Level, ±1.0 dB Error			-55.9		dBm
Temperature Drift Error	Log conformance error deviation from 25°C -40°C < T <sub>A</sub> < +105°C, P <sub>RFIN</sub> = -45 dBm		-0.13/-0.06 <sup>1</sup>		dB
	-40°C < T <sub>A</sub> < +105°C, P <sub>RFIN</sub> = -10 dBm		-0.73/+0.55 <sup>1</sup>		dB
Logarithmic Slope	Linear regression from -45 dBm to -10 dBm		-19.0		mV/dB
Logarithmic Intercept	Linear regression from -45 dBm to -10 dBm		-6.8		dBm
Output Voltage-High Power Input	P <sub>RFIN</sub> = -5 dBm		2		mV
Output Voltage-Low Power Input	P <sub>RFIN</sub> = -50 dBm		819		mV
- Slope Mode, 10 GHz	ENBL = VPOS/2				
±1.0 dB Error Dynamic Range			49.9		dB
Maximum Input Level, ±1.0 dB Error			-5.5		dBm
Minimum Input Level, ±1.0 dB Error			-55.4		dBm
Temperature Drift Error	Log conformance error deviation from 25°C -40°C < T <sub>A</sub> < +105°C, P <sub>RFIN</sub> = -45 dBm		-0.19/-0.29 <sup>1</sup>		dB
	-40°C < T <sub>A</sub> < +105°C, P <sub>RFIN</sub> = -10 dBm		-0.77/+0.25 <sup>1</sup>		dB
Logarithmic Slope	Linear regression from -45 dBm to -10 dBm		-19.3		mV/dB
Logarithmic Intercept	Linear regression from -45 dBm to -10 dBm		-6.4		dBm
Output Voltage-High Power Input	P <sub>RFIN</sub> = -5 dBm		2		mV
Output Voltage-Low Power Input	P <sub>RFIN</sub> = -50 dBm		839		mV
- Slope Mode, 12 GHz	ENBL = VPOS/2				
±1.0 dB Error Dynamic Range			48.8		dB
Maximum Input Level, ±1.0 dB Error			-1.3		dBm
Minimum Input Level, ±1.0 dB Error			-50.1		dBm
Temperature Drift Error	Log conformance error deviation from 25°C -40°C < T <sub>A</sub> < +105°C, P <sub>RFIN</sub> = -45 dBm		-0.39/-0.03 <sup>1</sup>		dB
	-40°C < T <sub>A</sub> < +105°C, P <sub>RFIN</sub> = -10 dBm		-1.09/+0.58 <sup>1</sup>		dB
Logarithmic Slope	Linear regression from -45 dBm to -10 dBm		-19.7		mV/dB
Logarithmic Intercept	Linear regression from -45 dBm to -10 dBm		-1.8		dBm
Output Voltage-High Power Input	P <sub>RFIN</sub> = -5 dBm		57		mV

**SPECIFICATIONS****Table 1. Specifications (Continued)**

Parameter	Test Conditions/Comments	Min	Typ	Max	Unit
Output Voltage-Low Power Input	$P_{RFIN} = -50$ dBm		930		mV

<sup>1</sup> The slash indicates a range. For example, +0.9/-0.6 means +0.9 to -0.6.

## ABSOLUTE MAXIMUM RATINGS

**Table 2. Absolute Maximum Ratings**

Parameter	Rating
Supply Voltage (VPOS)	3.6 V
DC Voltage at RFIN, ENBL, CFLT	-0.3 V to VPOS + 0.3 V
RF Input Power, RFIN <sup>1, 2, 3</sup>	
Average	15 dBm
Peak	18 dBm
Short Circuit Duration at VLOG	Indefinite
$\theta_{JA}$ (WLCSP)	260°C/W
Maximum Junction Temperature ( $T_J$ )	+125°C
Operating Temperature Range	-40°C to +105°C
Storage Temperature Range	-65°C to +150°C
Soldering Conditions	JEDEC J-STD-020

<sup>1</sup> Driven from a 50  $\Omega$  source.

<sup>2</sup> Under 50  $\Omega$  input matched condition.

<sup>3</sup> Guaranteed by design. Not production tested.

Stresses at or above those listed under Absolute Maximum Ratings may cause permanent damage to the product. This is a stress rating only; functional operation of the product at these or any other conditions above those indicated in the operational section of this specification is not implied. Operation beyond the maximum operating conditions for extended periods may affect product reliability.

## ESD CAUTION



**ESD (electrostatic discharge) sensitive device.** Charged devices and circuit boards can discharge without detection. Although this product features patented or proprietary protection circuitry, damage may occur on devices subjected to high energy ESD. Therefore, proper ESD precautions should be taken to avoid performance degradation or loss of functionality.

## PIN CONFIGURATION AND FUNCTION DESCRIPTIONS

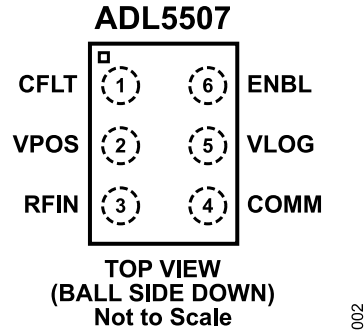

Figure 2. Pin Configuration

Table 3. Pin Function Descriptions

Pin No.	Mnemonic	Description
1	CFLT	An optional capacitor connected between CFLT and VLOG (pin 5) reduces the detector ripple averaging bandwidth. It slows the response of the output and reduces noise seen on the output.
2	VPOS	Positive DC power supply. Bypass externally with a 100 pF and a 0.1 $\mu$ F low ESR capacitors near this pin to ground.
3	RFIN	RF input. Internally ac-coupled with an on-chip 25 pF series capacitor. Connect a 51 $\Omega$ shunt resistor as close as possible to this pin for a broadband 50 $\Omega$ match.
4	COMM	Device common (Ground). Connect this pin to system ground using a low impedance path.
5	VLOG	Logarithmic output. The DC output voltage at this pin is linearly proportional to the RF signal level applied to RFIN (pin 3) in dBm. In shutdown (ENBL = low) this interface becomes high-impedance to avoid discharge of external filter capacitors.
6	ENBL	Device enable and output response selection. Connect the ENBL pin to a logic high to enable the device and select positive output slope mode. Float, or apply VPOS/2 to the ENBL pin to enable the device and select negative output slope mode. When it is floating, the ENBL pin self-biases to approximately half of the voltage on VPOS (pin 2). Connect the ENBL pin to a logic low to disable the device.

TYPICAL PERFORMANCE CHARACTERISTICS

VPOS = 3.3 V, ENBL = 3.3 V for positive slope mode, ENBL = VPOS/2 for negative slope mode,  $T_A = +25^\circ\text{C}$  (black),  $+85^\circ\text{C}$  (red),  $+105^\circ\text{C}$  (gold), and  $-40^\circ\text{C}$  (blue) where applicable. CFLT = open, unless otherwise noted. Input RF signal is a sine wave (CW), unless otherwise indicated. Power referenced to 50  $\Omega$  source and with a 51  $\Omega$  shunt matching resistor on the board. Measured with 6 dB attenuator pad between RF signal source output and test board input. Distribution plots based upon more than 30 devices.

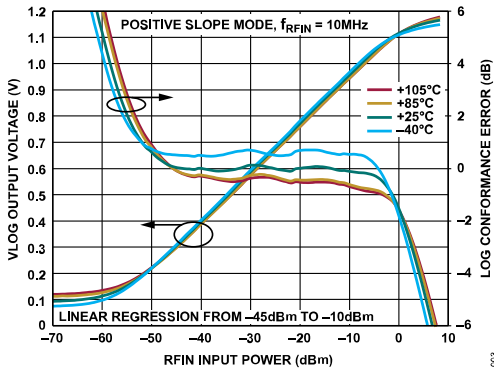

Figure 3.  $V_{LOG}$  and Log Conformance Error vs.  $P_{RFIN}$  Over Temperature at 10 MHz, Positive Slope Mode

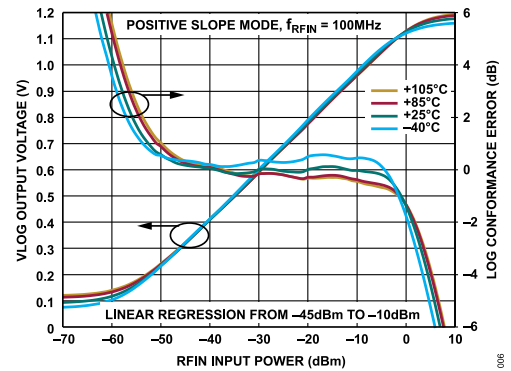

Figure 6.  $V_{LOG}$  and Log Conformance Error vs.  $P_{RFIN}$  Over Temperature at 100 MHz, Positive Slope Mode

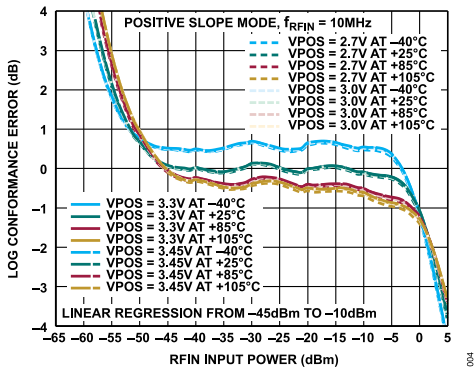

Figure 4. Log Conformance Error vs.  $P_{RFIN}$  Over Temperature and VPOS at 10 MHz, Positive Slope Mode

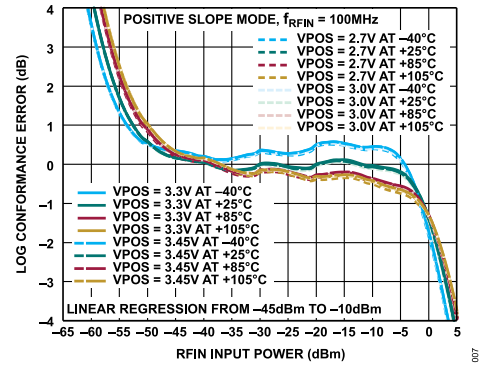

Figure 7. Log Conformance Error vs.  $P_{RFIN}$  Over Temperature and VPOS at 100 MHz, Positive Slope Mode

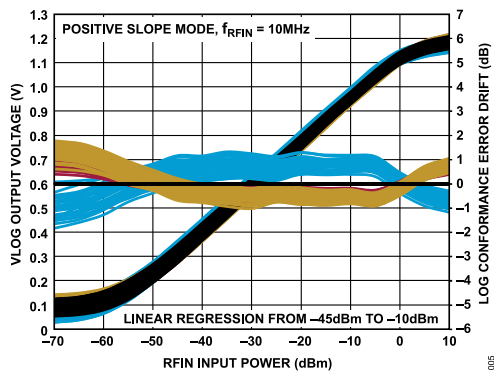

Figure 5. Distribution of  $V_{LOG}$  and Log Conformance Error Drift with Respect to  $25^\circ\text{C}$  vs.  $P_{RFIN}$  at 10 MHz, Positive Slope Mode

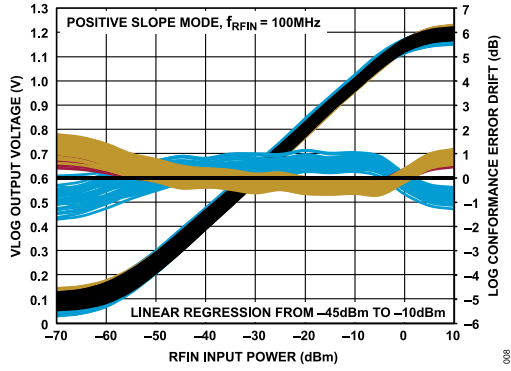

Figure 8. Distribution of  $V_{LOG}$  and Log Conformance Error Drift with Respect to  $25^\circ\text{C}$  vs.  $P_{RFIN}$  at 100 MHz, Positive Slope Mode

TYPICAL PERFORMANCE CHARACTERISTICS

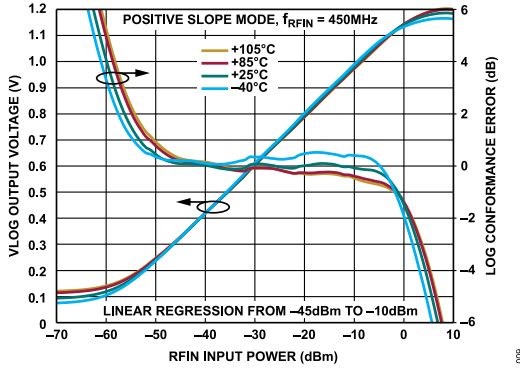

Figure 9.  $V_{VLOG}$  and Log Conformance Error vs.  $P_{RFIN}$  Over Temperature at 450 MHz, Positive Slope Mode

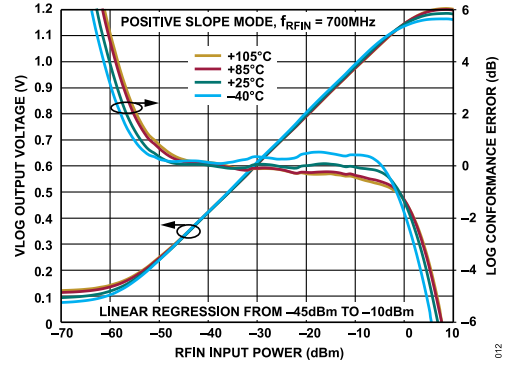

Figure 12.  $V_{VLOG}$  and Log Conformance Error vs.  $P_{RFIN}$  Over Temperature at 700 MHz, Positive Slope Mode

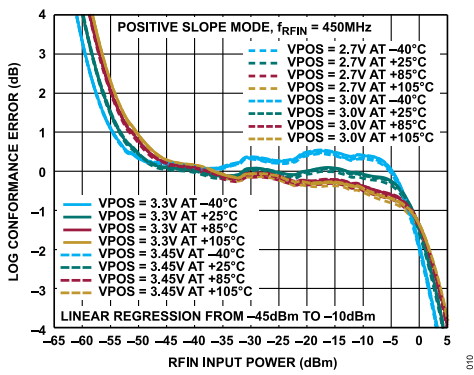

Figure 10. Log Conformance Error vs.  $P_{RFIN}$  Over Temperature and VPOS at 450 MHz, Positive Slope Mode

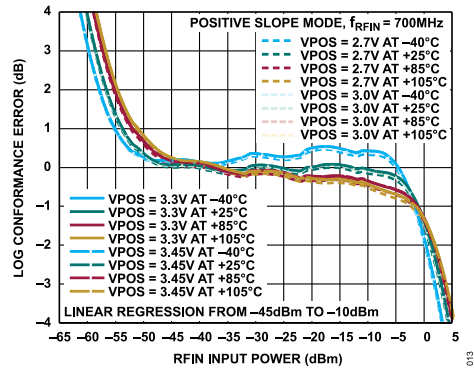

Figure 13. Log Conformance Error vs.  $P_{RFIN}$  Over Temperature and VPOS at 700 MHz, Positive Slope Mode

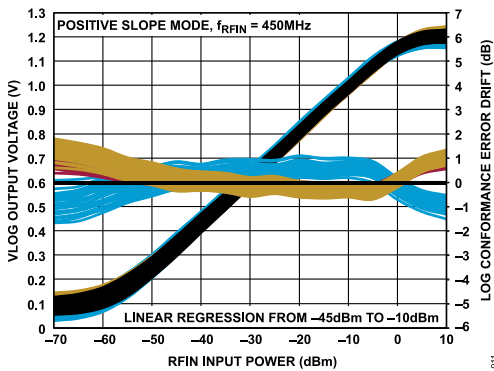

Figure 11. Distribution of  $V_{VLOG}$  and Log Conformance Error Drift with Respect to 25°C vs.  $P_{RFIN}$  at 450 MHz, Positive Slope Mode

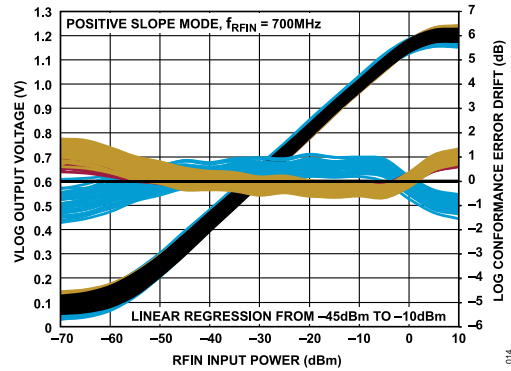

Figure 14. Distribution of  $V_{VLOG}$  and Log Conformance Error Drift with Respect to 25°C vs.  $P_{RFIN}$  at 700 MHz, Positive Slope Mode

TYPICAL PERFORMANCE CHARACTERISTICS

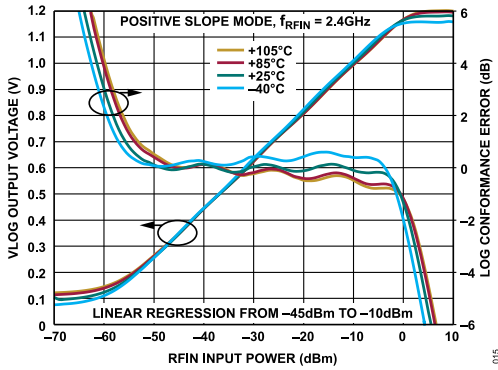

Figure 15.  $V_{VLOG}$  and Log Conformance Error vs.  $P_{RFIN}$  Over Temperature at 2.4 GHz, Positive Slope Mode

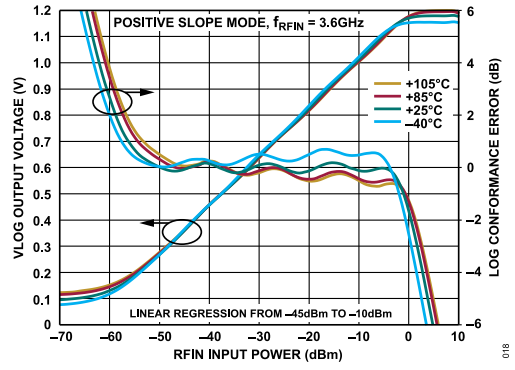

Figure 18.  $V_{VLOG}$  and Log Conformance Error vs.  $P_{RFIN}$  Over Temperature at 3.6 GHz, Positive Slope Mode

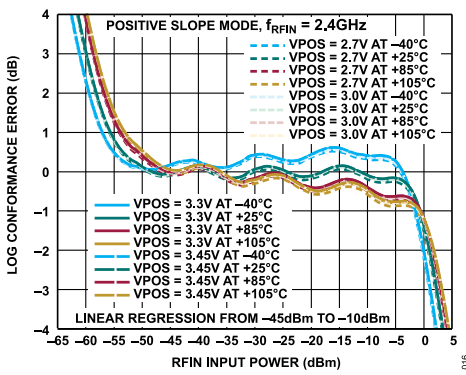

Figure 16. Log Conformance Error vs.  $P_{RFIN}$  Over Temperature and VPOS at 2.4 GHz, Positive Slope Mode

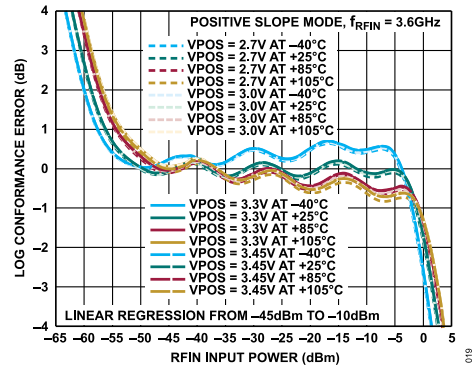

Figure 19. Log Conformance Error vs.  $P_{RFIN}$  Over Temperature and VPOS at 3.6 GHz, Positive Slope Mode

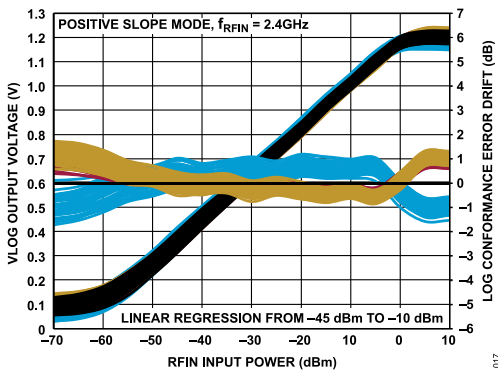

Figure 17. Distribution of  $V_{VLOG}$  and Log Conformance Error Drift with Respect to 25°C vs.  $P_{RFIN}$  at 2.4 GHz, Positive Slope Mode

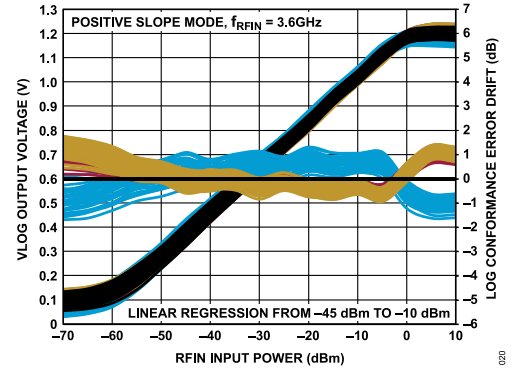

Figure 20. Distribution of  $V_{VLOG}$  and Log Conformance Error Drift with Respect to 25°C vs.  $P_{RFIN}$  at 3.6 GHz, Positive Slope Mode



TYPICAL PERFORMANCE CHARACTERISTICS

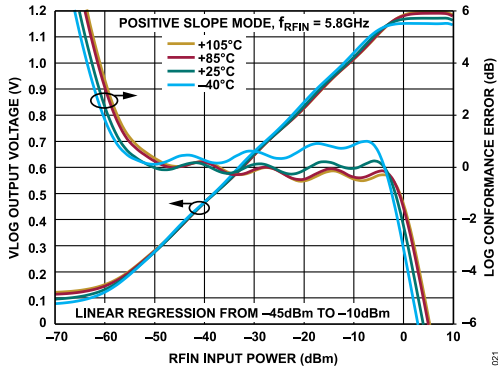

Figure 21.  $V_{LOG}$  and Log Conformance Error vs.  $P_{RFIN}$  Over Temperature at 5.8 GHz, Positive Slope Mode

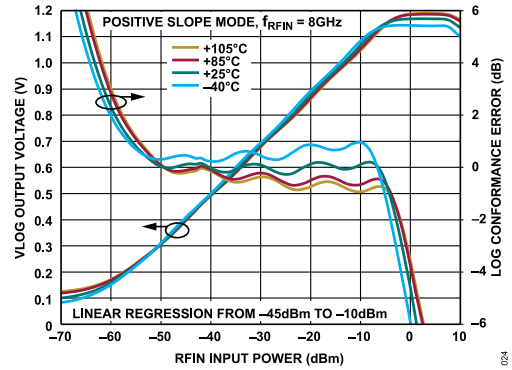

Figure 24.  $V_{LOG}$  and Log Conformance Error vs.  $P_{RFIN}$  Over Temperature at 8 GHz, Positive Slope Mode

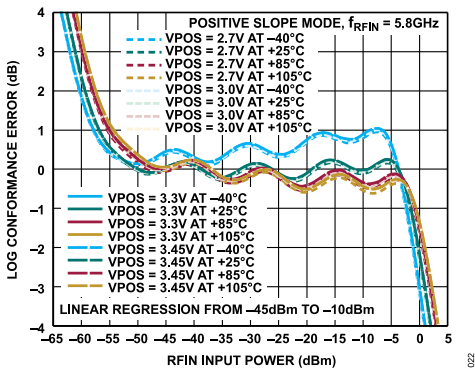

Figure 22. Log Conformance Error vs.  $P_{RFIN}$  Over Temperature and VPOS at 5.8 GHz, Positive Slope Mode

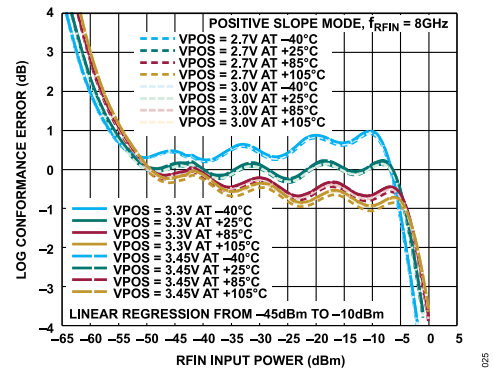

Figure 25. Log Conformance Error vs.  $P_{RFIN}$  Over Temperature and VPOS at 8 GHz, Positive Slope Mode

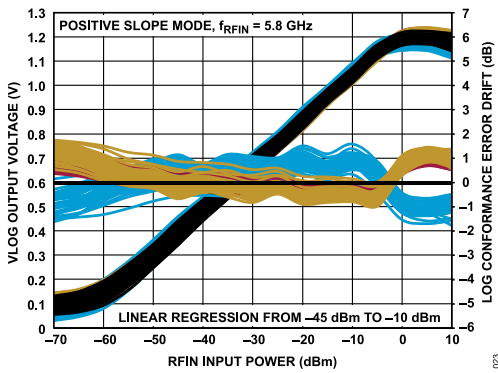

Figure 23. Distribution of  $V_{LOG}$  and Log Conformance Error Drift with Respect to 25°C vs.  $P_{RFIN}$  at 5.8 GHz, Positive Slope Mode

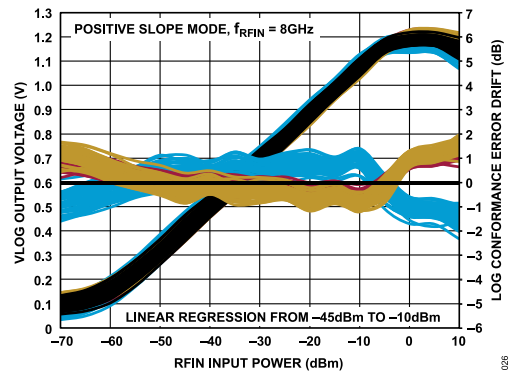

Figure 26. Distribution of  $V_{LOG}$  and Log Conformance Error Drift with Respect to 25°C vs.  $P_{RFIN}$  at 8 GHz, Positive Slope Mode

TYPICAL PERFORMANCE CHARACTERISTICS

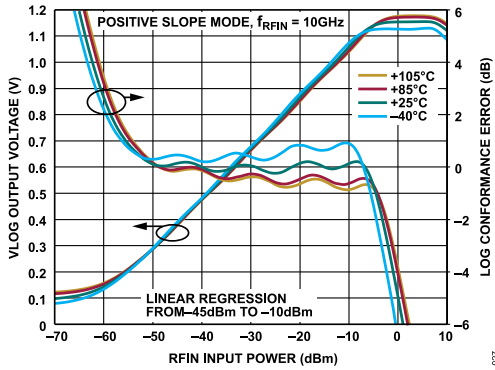

Figure 27.  $V_{LOG}$  and Log Conformance Error vs.  $P_{RFIN}$  Over Temperature at 10 GHz, Positive Slope Mode

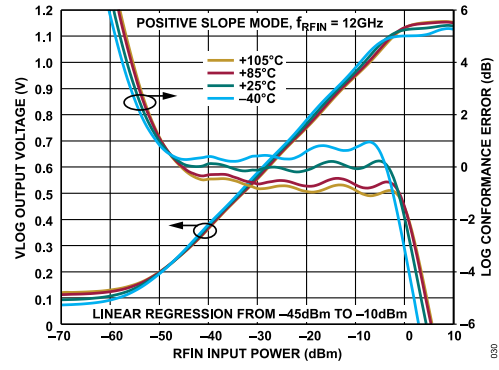

Figure 30.  $V_{LOG}$  and Log Conformance Error vs.  $P_{RFIN}$  Over Temperature at 12 GHz, Positive Slope Mode

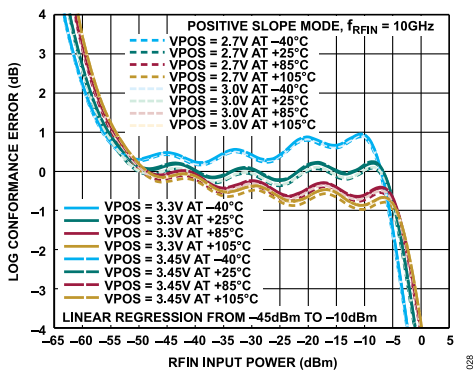

Figure 28. Log Conformance Error vs.  $P_{RFIN}$  Over Temperature and VPOS at 10 GHz, Positive Slope Mode

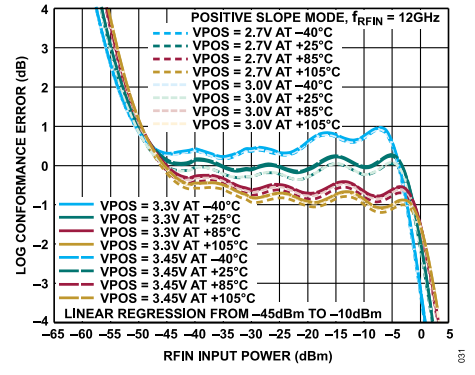

Figure 31. Log Conformance Error vs.  $P_{RFIN}$  Over Temperature and VPOS at 12 GHz, Positive Slope Mode

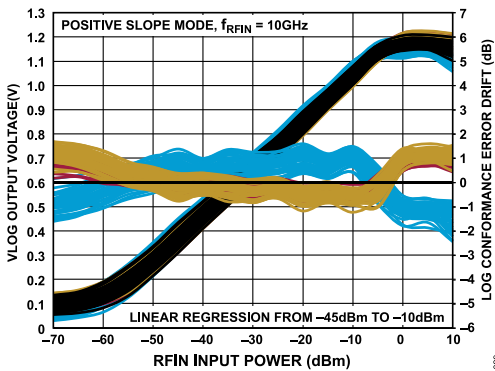

Figure 29. Distribution of  $V_{LOG}$  and Log Conformance Error Drift with Respect to 25°C vs.  $P_{RFIN}$  at 10GHz, Positive Slope Mode

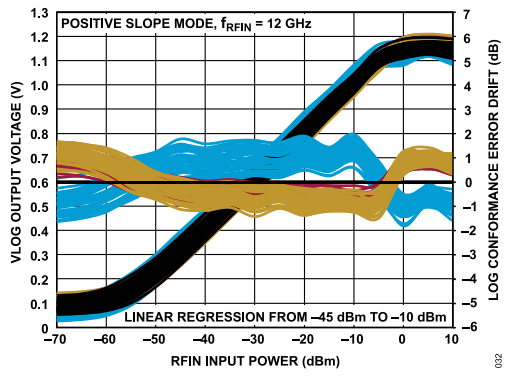

Figure 32. Distribution of  $V_{LOG}$  and Log Conformance Error Drift with Respect to 25°C vs.  $P_{RFIN}$  at 12 GHz, Positive Slope Mode

TYPICAL PERFORMANCE CHARACTERISTICS

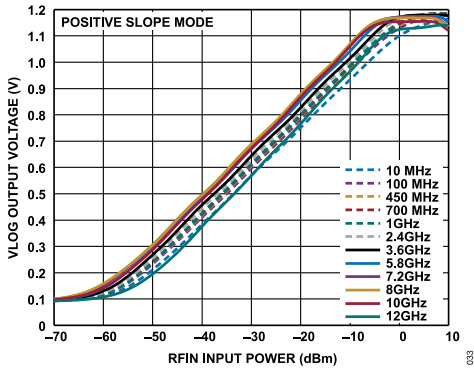

Figure 33.  $V_{LOG}$  vs.  $P_{RFIN}$  Over Frequencies, Positive Slope Mode

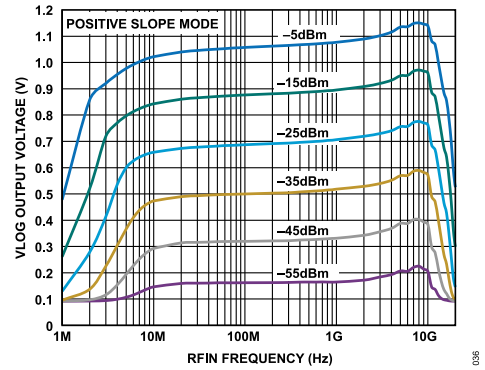

Figure 36.  $V_{LOG}$  vs.  $f_{RFIN}$  in Log Scale Over Input Powers, Positive Slope Mode

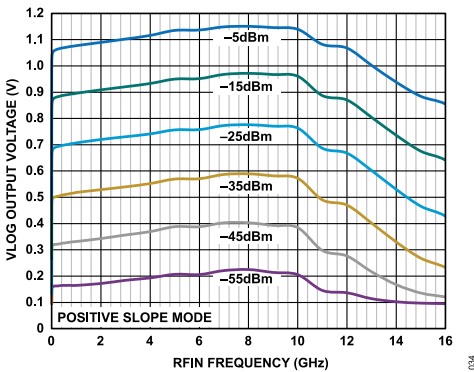

Figure 34.  $V_{LOG}$  vs.  $f_{RFIN}$  in Linear Scale Over Input Power, Positive Slope Mode

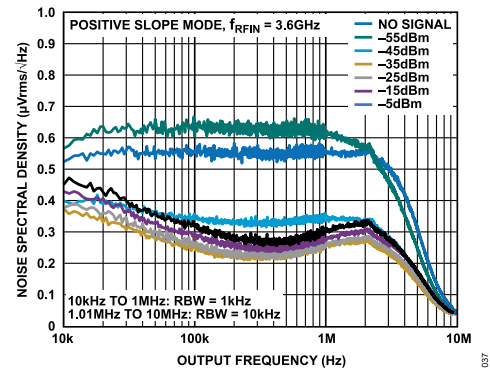

Figure 37. Output Noise Spectral Density for Various RF Powers at 3.6 GHz, Positive Slope Mode

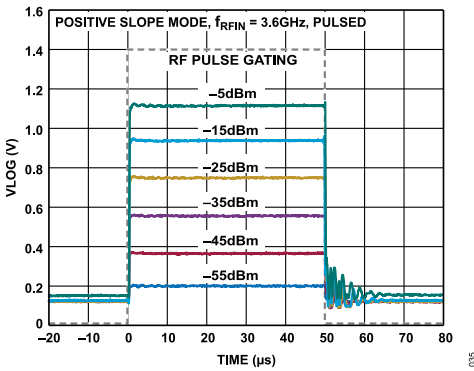

Figure 35. Output Transient Response to RF Input Pulse for Various RF powers at 3.6GHz

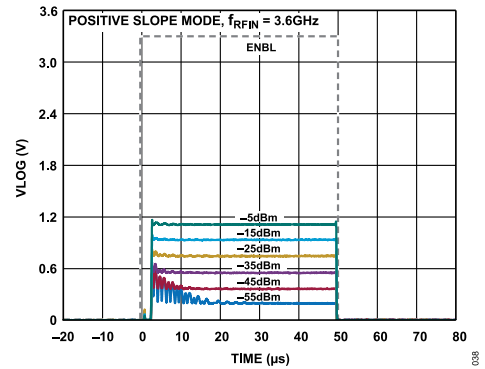

Figure 38. Output Transient Response with CW RF and Enable Pulse for Various RF Powers at 3.6 GHz, Positive Slope Mode

TYPICAL PERFORMANCE CHARACTERISTICS

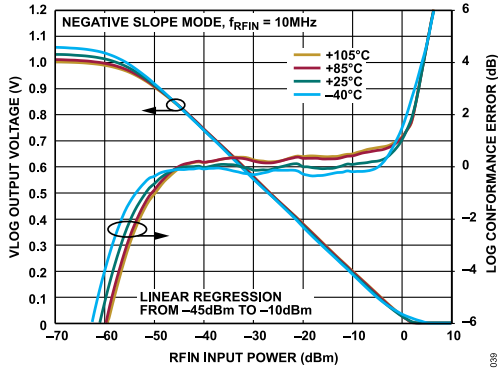

Figure 39.  $V_{LOG}$  and Log Conformance Error vs.  $P_{RFIN}$  Over Temperature at 10 MHz, Negative Slope Mode

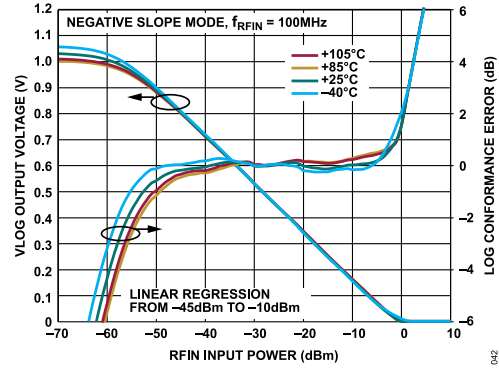

Figure 42.  $V_{LOG}$  and Log Conformance Error vs.  $P_{RFIN}$  Over Temperature at 100 MHz, Negative Slope Mode

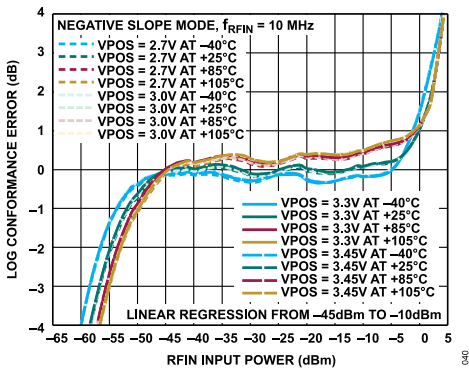

Figure 40. Log Conformance Error vs.  $P_{RFIN}$  Over Temperature and VPOS at 10 MHz, Negative Slope Mode

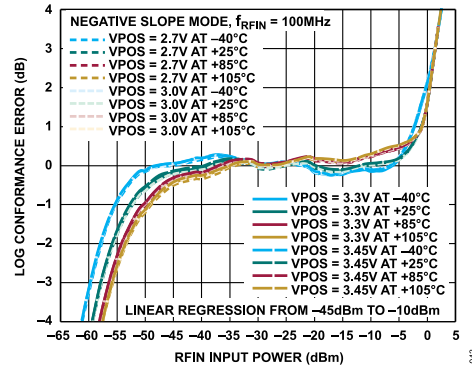

Figure 43. Log Conformance Error vs.  $P_{RFIN}$  Over Temperature and VPOS at 100 MHz, Negative Slope Mode

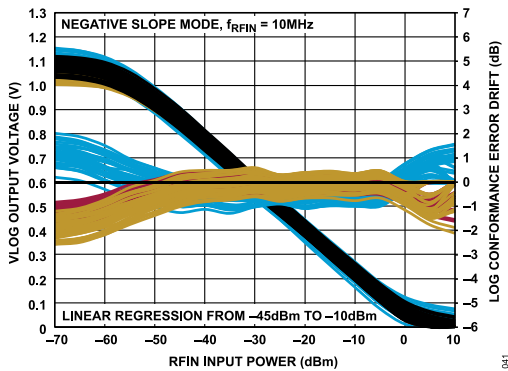

Figure 41. Distribution of  $V_{LOG}$  and Log Conformance Error Drift with Respect to 25°C vs.  $P_{RFIN}$  at 10 MHz, Negative Slope Mode

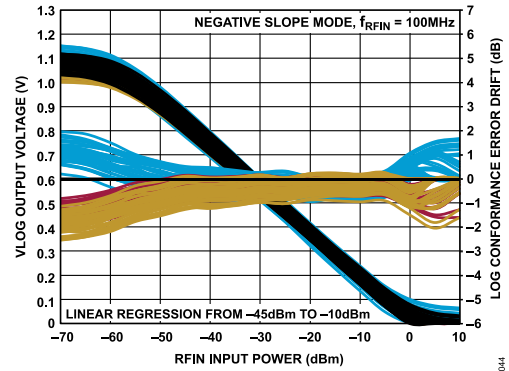

Figure 44. Distribution of  $V_{LOG}$  and Log Conformance Error Drift with Respect to 25°C vs.  $P_{RFIN}$  at 100 MHz, Negative Slope Mode

TYPICAL PERFORMANCE CHARACTERISTICS

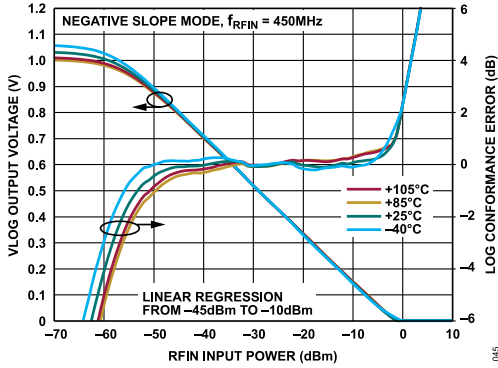

Figure 45.  $V_{VLOG}$  and Log Conformance Error vs.  $P_{RFIN}$  Over Temperature at 450 MHz, Negative Slope Mode

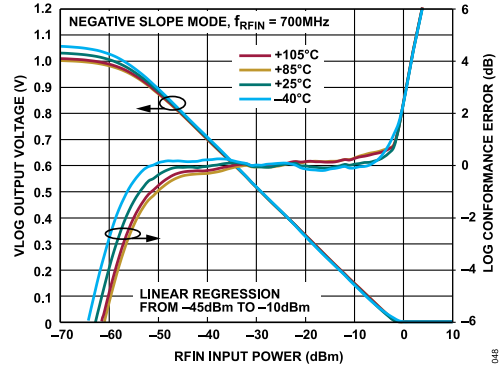

Figure 48.  $V_{VLOG}$  and Log Conformance Error vs.  $P_{RFIN}$  Over Temperature at 700 MHz, Negative Slope Mode

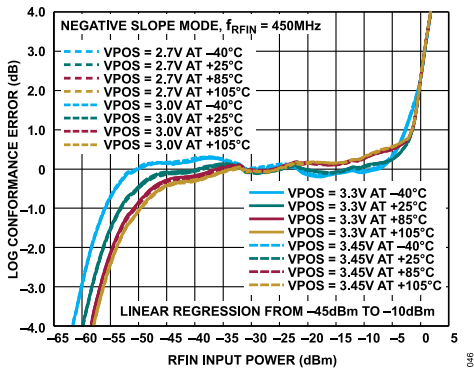

Figure 46. Log Conformance Error vs.  $P_{RFIN}$  Over Temperature and VPOS at 450 MHz, Negative Slope Mode

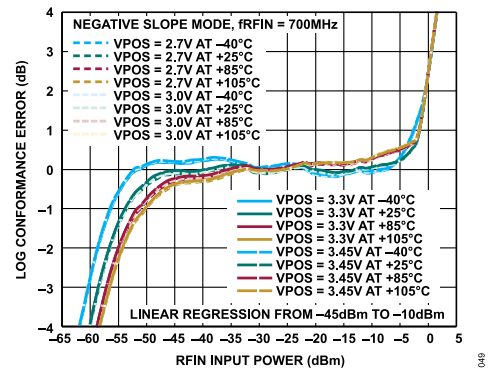

Figure 49. Log Conformance Error vs.  $P_{RFIN}$  Over Temperature and VPOS at 700 MHz, Negative Slope Mode

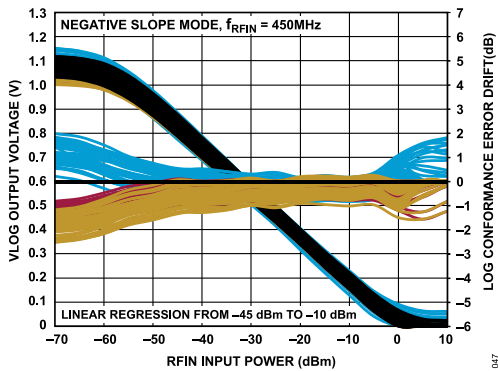

Figure 47. Distribution of  $V_{VLOG}$  and Log Conformance Error Drift with Respect to 25°C vs.  $P_{RFIN}$  at 450 MHz, Negative Slope Mode

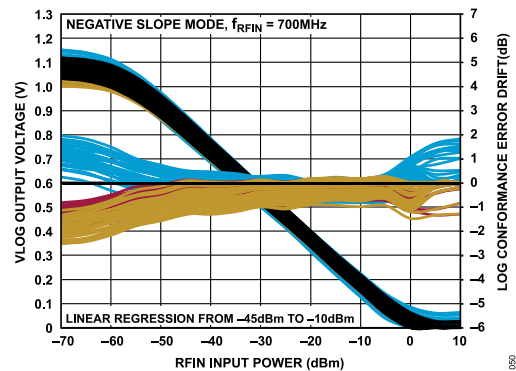

Figure 50. Distribution of  $V_{VLOG}$  and Log Conformance Error Drift with Respect to 25°C vs.  $P_{RFIN}$  at 700 MHz, Negative Slope Mode

TYPICAL PERFORMANCE CHARACTERISTICS

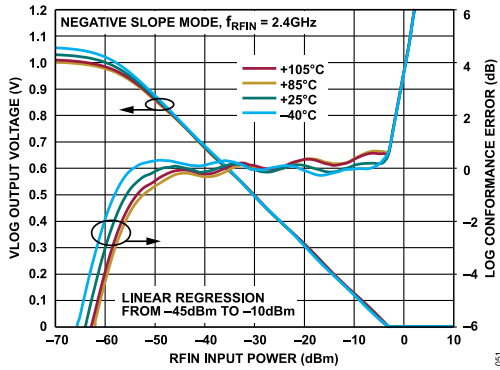

Figure 51.  $V_{LOG}$  and Log Conformance Error vs.  $P_{RFIN}$  Over Temperature at 2.4 GHz, Negative Slope Mode

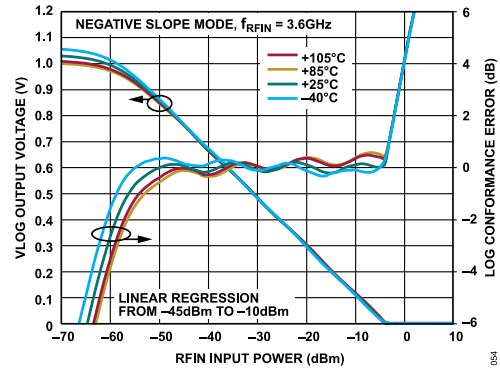

Figure 54.  $V_{LOG}$  and Log Conformance Error vs.  $P_{RFIN}$  Over Temperature at 3.6 GHz, Negative Slope Mode

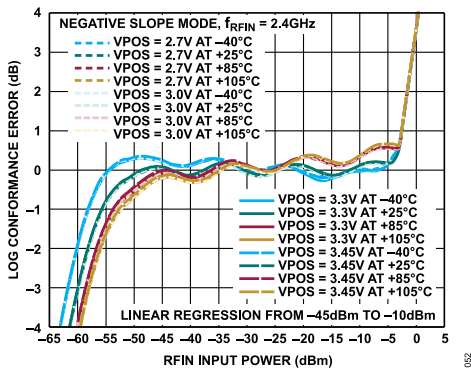

Figure 52. Log Conformance Error vs.  $P_{RFIN}$  Over Temperature and VPOS at 2.4 GHz, Negative Slope Mode

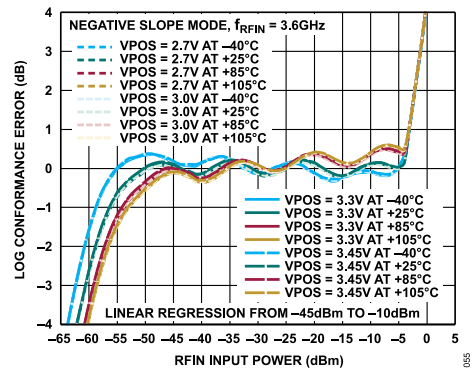

Figure 55. Log Conformance Error vs.  $P_{RFIN}$  Over Temperature and VPOS at 3.6 GHz, Negative Slope Mode

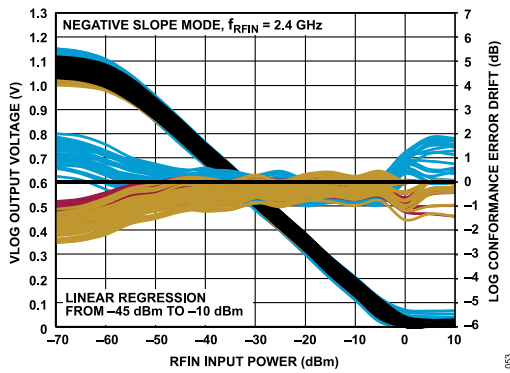

Figure 53. Distribution of  $V_{LOG}$  and Log Conformance Error Drift with Respect to 25°C vs.  $P_{RFIN}$  at 2.4 GHz, Negative Slope Mode

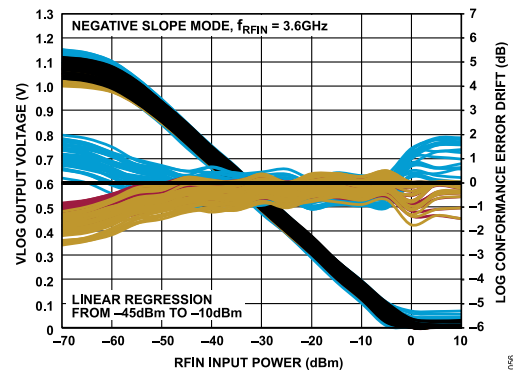

Figure 56. Distribution of  $V_{LOG}$  and Log Conformance Error Drift with Respect to 25°C vs.  $P_{RFIN}$  at 3.6 GHz, Negative Slope Mode



TYPICAL PERFORMANCE CHARACTERISTICS

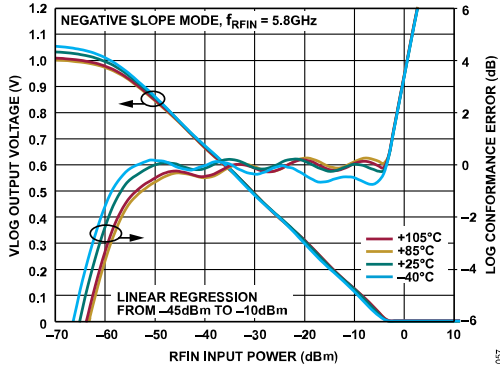

Figure 57.  $V_{VLOG}$  and Log Conformance Error vs.  $P_{RFIN}$  Over Temperature at 5.8 GHz, Negative Slope Mode

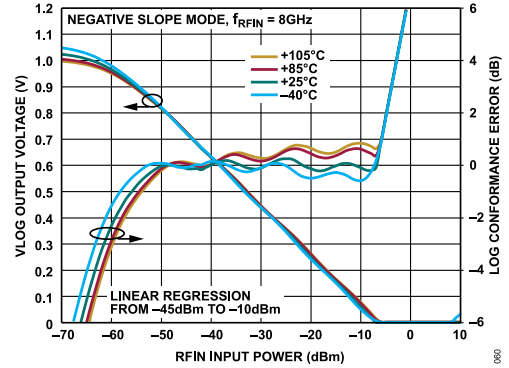

Figure 60.  $V_{VLOG}$  and Log Conformance Error vs.  $P_{RFIN}$  Over Temperature at 8 GHz, Negative Slope Mode

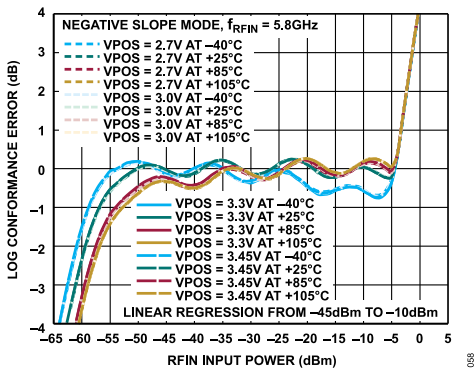

Figure 58. Log Conformance Error vs.  $P_{RFIN}$  Over Temperature and VPOS at 5.8 GHz, Negative Slope Mode

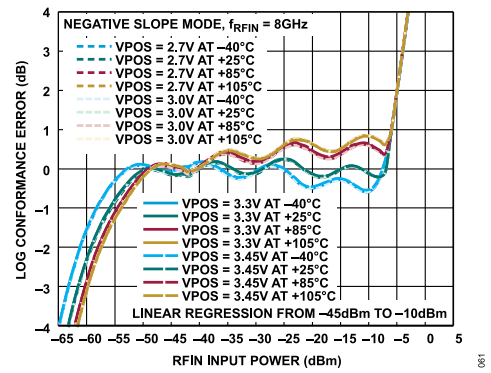

Figure 61. Log Conformance Error vs.  $P_{RFIN}$  Over Temperature and VPOS at 8 GHz, Negative Slope Mode

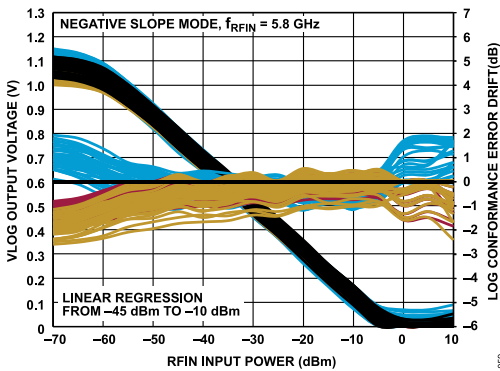

Figure 59. Distribution of  $V_{VLOG}$  and Log Conformance Error Drift with Respect to 25°C vs.  $P_{RFIN}$  at 5.8 GHz, Negative Slope Mode

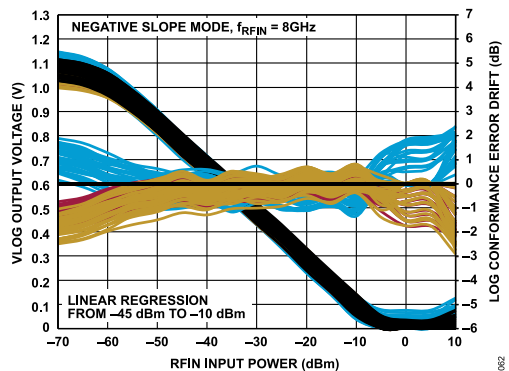

Figure 62. Distribution of  $V_{VLOG}$  and Log Conformance Error Drift with Respect to 25°C vs.  $P_{RFIN}$  at 8 GHz, Negative Slope Mode

TYPICAL PERFORMANCE CHARACTERISTICS

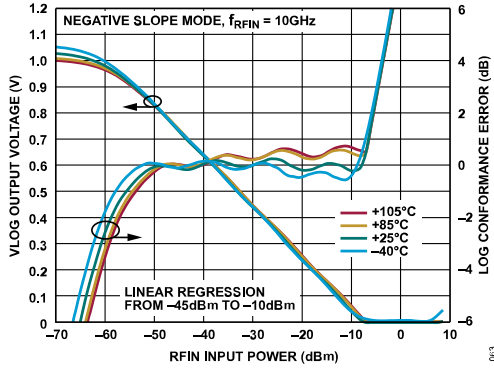

Figure 63.  $V_{LOG}$  and Log Conformance Error vs.  $P_{RFIN}$  Over Temperature at 10 GHz, Negative Slope Mode

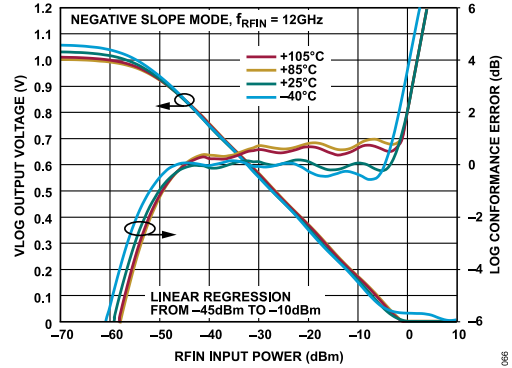

Figure 66.  $V_{LOG}$  and Log Conformance Error vs.  $P_{RFIN}$  Over Temperature at 12 GHz, Negative Slope Mode

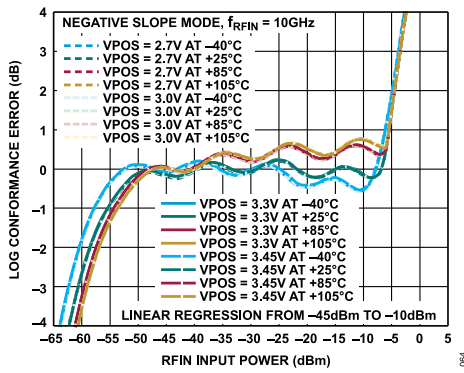

Figure 64. Log Conformance Error vs.  $P_{RFIN}$  Over Temperature and VPOS at 10 GHz, Negative Slope Mode

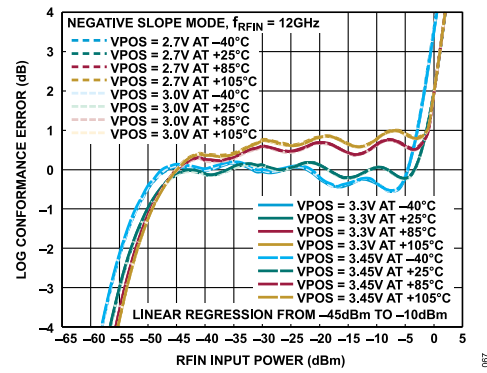

Figure 67. Log Conformance Error vs.  $P_{RFIN}$  Over Temperature and VPOS at 12 GHz, Negative Slope Mode

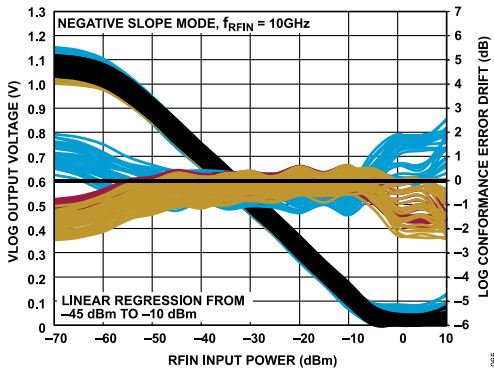

Figure 65. Distribution of  $V_{LOG}$  and Log Conformance Error Drift with Respect to 25°C vs.  $P_{RFIN}$  at 10 GHz, Negative Slope Mode

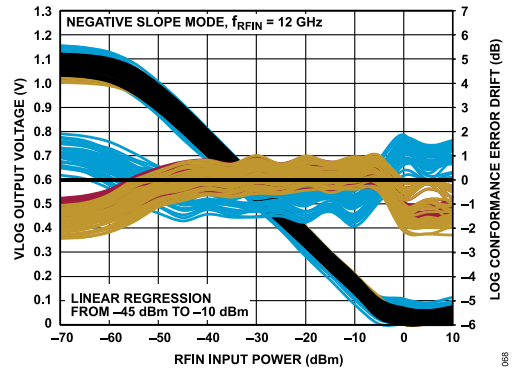

Figure 68. Distribution of  $V_{LOG}$  and Log Conformance Error Drift with Respect to 25°C vs.  $P_{RFIN}$  at 12 GHz, Negative Slope Mode



TYPICAL PERFORMANCE CHARACTERISTICS

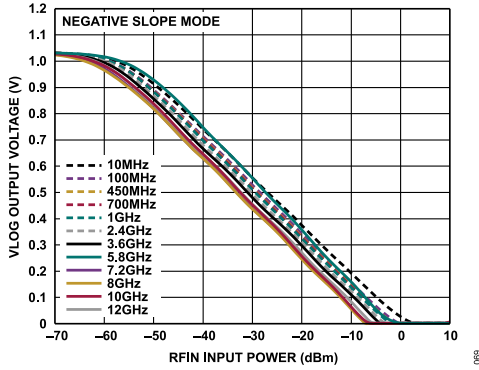

Figure 69.  $V_{LOG}$  vs.  $P_{RFIN}$  Over Frequencies, Negative Slope Mode

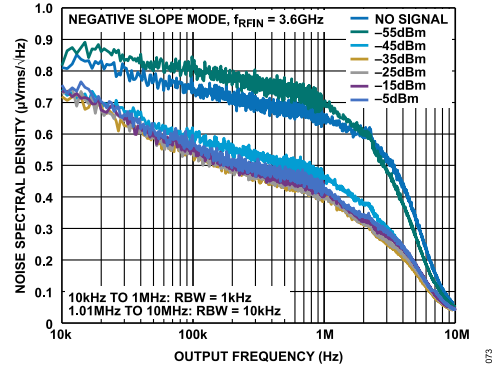

Figure 72. Output Noise Spectral Density for Various RF Powers at 3.6 GHz, Negative Slope Mode

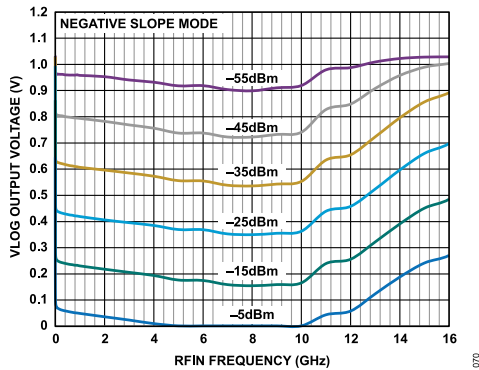

Figure 70.  $V_{LOG}$  vs.  $f_{RFIN}$  in Linear Scale Over Input Powers, Negative Slope Mode

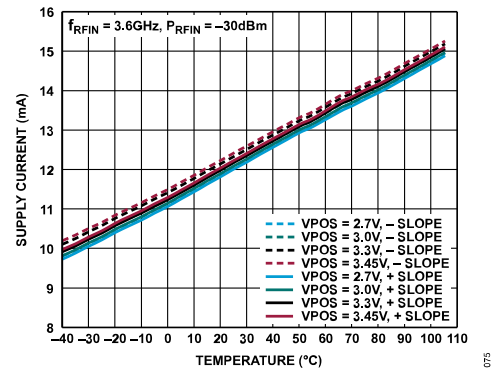

Figure 73. Supply Current vs. Temperature at Various Supply Voltages

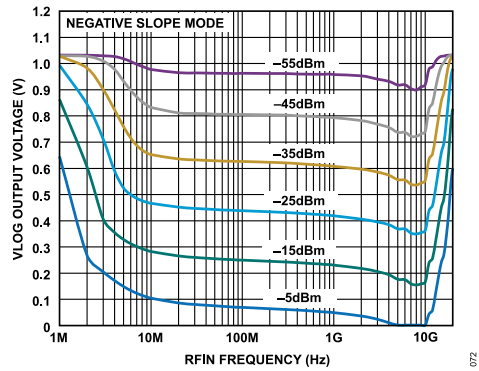

Figure 71.  $V_{LOG}$  vs.  $f_{RFIN}$  in Log Scale Over Input Powers, Negative Slope Mode

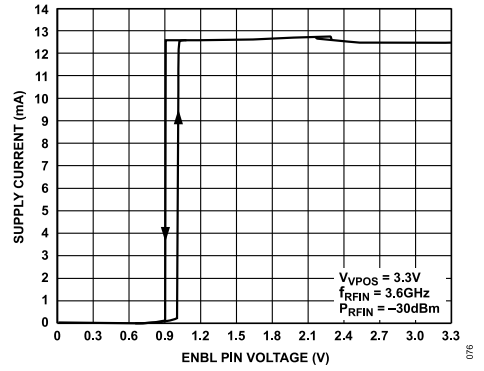

Figure 74. Supply Current vs. ENBL Pin Voltage

TYPICAL PERFORMANCE CHARACTERISTICS

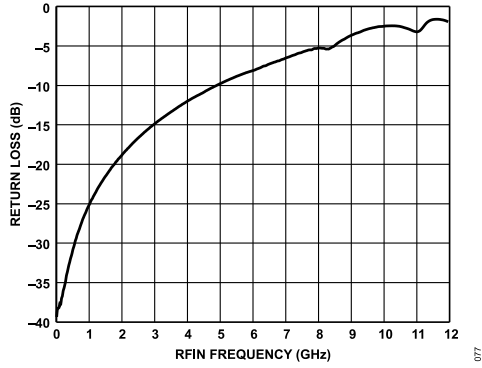

Figure 75. Input Return Loss vs. Frequency

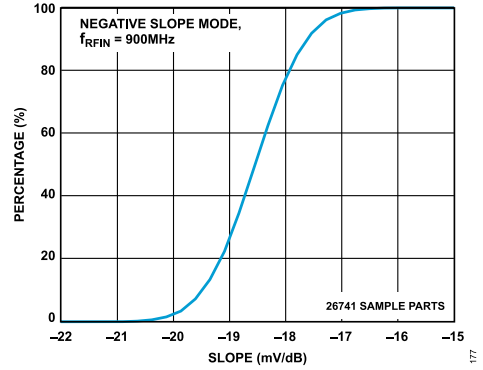

Figure 78. Slope Distribution at 900 MHz, Negative Slope Mode

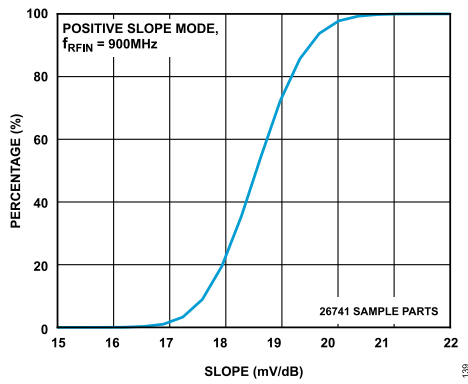

Figure 76. Slope Distribution at 900 MHz, Positive Slope Mode

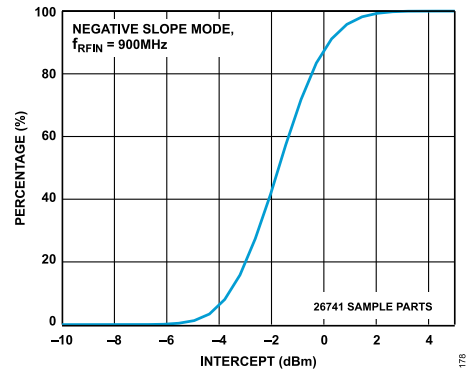

Figure 79. Intercept Distribution at 900 MHz, Negative Slope Mode

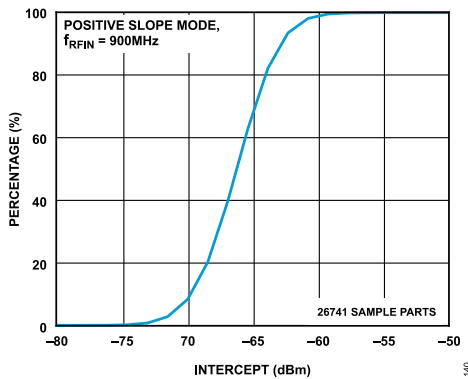

Figure 77. Intercept Distribution at 900 MHz, Positive Slope Mode

MEASUREMENT SETUPS

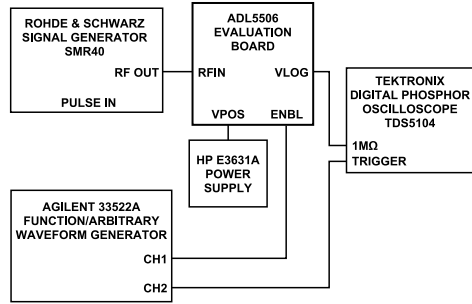

Figure 80. Hardware Configuration for Output Response to ENBL Pin Gating Measurements

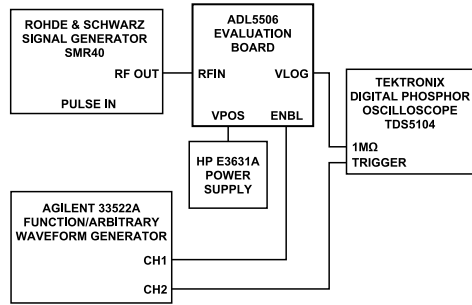

Figure 81. Hardware Configuration for Output Response to RF Pulse Input Measurements

## THEORY OF OPERATION

The [ADL5507](#) is a logarithmic detector (log amp), based on the principle of successive compression. It is fabricated on an advanced BiCMOS process. It comes in a smaller 0.8 mm × 1.2 mm WLCSP package and offers 12 GHz RF bandwidth. [Functional Block Diagram](#) shows the main features of the ADL5507 in block schematic form.

The ADL5507 combines two key functions needed for the measurement of signal level over a moderately wide dynamic range. First, it provides the amplification needed to respond to small signals in a chain of four amplifier/limiter cells, each having a small signal gain of 13 dB and a bandwidth of approximately 12 GHz. At the output of each amplifier stage is a full wave rectifier, essentially a square law detector cell that converts the RF signal voltages to a fluctuating current with an average value that increases with signal level. A further passive detector stage is added preceding the first stage. Therefore, there are five detectors, each separated by 13 dB, giving about 52 dB of total gain and approximately 55 dB of dynamic range. The overall accuracy at the extremes of this total range, viewed as the deviation from an ideal logarithmic response, that is, the log conformance error, can be judged by referencing the figure in the [Typical Performance Characteristics](#) section, which show that errors across the central 55 dB are moderate. These figures show how the conformance to an ideal logarithmic function varies with temperature, frequency, and supply voltage.

The output of these detector cells is in the form of a differential current, making their summation a simple matter. It can easily be shown that such summation closely approximates a logarithmic function. The summed differential current polarity can be swapped (thereby changing the slope polarity) by setting the ENBL pin voltage to VPOS/2 (or floating) for negative slope or VPOS for positive slope. This result is then converted to a voltage at the

VLOG pin through a high gain stage. This output is connected back to a voltage-to-current (V-to-I) stage, in such a manner that  $V_{VLOG}$  is a logarithmic measure of the RF input voltage with a slope and intercept controlled by the design. For a fixed termination resistance at the input of the ADL5507, a given voltage corresponds to a certain power level.

The external termination added before the ADL5507 determines the effective power scaling. This often takes the form of a simple resistor (51  $\Omega$  provides a net 50  $\Omega$  input), but more elaborate matching networks can be used. This impedance determines the logarithmic intercept, the input power for which the output crosses the baseline ( $V_{VLOG} = 0$  V) if the function were continuous for all values of input. Because this is never the case for a practical log amp, the intercept refers to the value obtained by the minimum error, straight line fit to the actual graph of  $V_{VLOG}$  vs. input power. The quoted values in [Specifications](#) assume a sinusoidal (CW) signal. In the place of complex modulation, as in 5G-NR, the calibration of the power response needs to be adjusted accordingly. Where a true power (waveform independent) response is needed, consider the use of an rms responding detector, such as the [ADL5906](#).

However, in terms of the logarithmic slope, the amount by which the output  $V_{VLOG}$  changes for each decibel of input change (voltage or power), is, in principle, independent of waveform or termination impedance. In practice, it usually falls off at higher frequencies because of the declining gain of the amplifier stages and other effects in the detector cells. The ADL5507, at 3.6 GHz, has a typical slope of 18.7 mV/dB in Positive Slope mode, and -18.7 mV/dB in Negative Slope mode. These values are sensibly independent of temperature and almost completely unaffected by supply voltages of 2.7 V to 3.45 V.

APPLICATIONS INFORMATION

BASIC CONNECTIONS

Figure 82 shows the basic connections for measurement mode. A supply voltage of 2.7 V to 3.45 V is required. Decouple the supply to the VPOS pin with a low inductance 0.1 μF surface-mount ceramic capacitor. A series resistor of about 10 Ω can be added; this resistor slightly reduces the supply voltage to the ADL5507 and depends on the load resistance at the output to ground. Avoid its use in applications where the power supply voltage is very low. A series inductor provides similar power supply filtering with minimal drop in supply voltage.

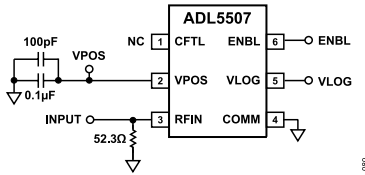

Figure 82. Basic Connections

The ADL5507 has an internal input coupling capacitor. This eliminates the need for external AC coupling. In this example, a broadband input match is achieved by connecting a 51 Ω resistor between RFIN and ground. This resistance combines with the internal input impedance to give an overall broadband input resistance of 50 Ω. Several other coupling methods are possible; these are described in the Input Coupling Options section.

Figure 83 shows the typical logarithmic conformance at 3.6 GHz.

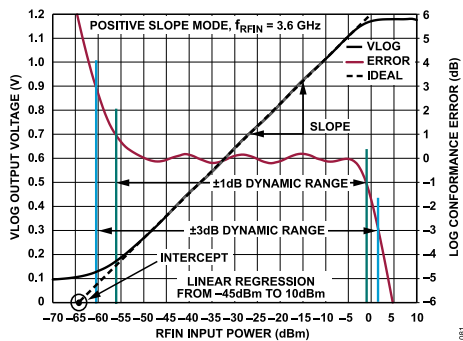

Figure 83.  $V_{VLOG}$  and Log Conformance Error vs. Input Level at 3.6 GHz

TRANSFER FUNCTION IN TERMS OF SLOPE AND INTERCEPT

The transfer function of the ADL5507 is characterized in terms of its slope and intercept. The logarithmic slope is defined as the change in the VLOG output voltage for a 1 dB change in RF power level at the RF input. For the ADL5507, the slope is nominally 18.7 mV/dB in positive slope response mode. Therefore, a 10 dB change at the input results in a change at the output of approximately 187 mV. Figure 83 shows the range over which the device maintains its constant slope. The dynamic range can be defined as the range over which the error remains within a certain band, usually ±1 dB or ±3 dB. In Figure 83 for example, the ±1 dB dynamic range is

approximately 55 dB (from -56 dBm to -1 dBm), and the ±3 dB dynamic range is approximately 62 dB (from -60.5 dBm to +1.5 dBm).

The intercept is the point at which the extrapolated linear response intersects the horizontal axis (see Figure 83). Using the slope and intercept, calculate the output voltage for any input level within the specified input range, or calculate the input level from the output voltage by the following complementary equations:

$$V_{VLOG} = SLOPE \times (P_{IN} - INTERCEPT) \tag{1}$$

$$P_{IN} = \frac{V_{VLOG}}{SLOPE} + INTERCEPT \tag{2}$$

where:

$V_{VLOG}$  is the power detector output voltage, in millivolts.

$P_{IN}$  is the input signal level, expressed in decibels relative to some reference level (dBm in this case).

$SLOPE$  is the logarithmic slope, expressed in mV/dB.

$INTERCEPT$  is the logarithmic intercept, expressed in decibels relative to the same reference level.

For example, at an input level of -25 dBm, the VLOG output voltage is  $V_{VLOG} = 18.7 \text{ mV/dB} \times [-25 \text{ dBm} - (-64.4 \text{ dBm})] = 737 \text{ mV}$ .

LOG CONFORMANCE ERROR CALCULATION

Log conformance error is expressed in terms of the deviation in the output voltage between the measured  $V_{VLOG}$  and the  $V_{VLOG}$  calculated with an ideal log transformation function. Ideally, the measured  $V_{VLOG}$  output at a particular input power, as plotted in Figure 83, must not deviate from the calculated value of  $V_{VLOG}$  at that same input power. Setting the measured  $V_{VLOG}$  to the right side of the preceding equation and rearranging yields

$$\frac{V_{VLOG, MEASURED}(P_{IN})}{SLOPE} - P_{IN} + INTERCEPT = 0 \tag{3}$$

In actuality, this does not always calculate to zero. The finite calculation that results is the log conformance error, as follows:

$$Error(P_{IN}) = \frac{V_{VLOG, MEASURED}(P_{IN})}{SLOPE} - P_{IN} + INTERCEPT \tag{4}$$

where  $Error$  is in dB.

The parameters  $SLOPE$  and  $INTERCEPT$  are best obtained from the actual detector response using linear regression over a suitable power range (where the detector response is close to linear). Better accuracy/smaller errors are obtained if  $SLOPE$  and  $INTERCEPT$  are determined for:

- ▶ Each detector device individually
- ▶ Each operating temperature

APPLICATIONS INFORMATION

- Each operating frequency

To achieve the best accuracy, it is recommended to determine *SLOPE* and *INTERCEPT* for each individual unit, requiring a two-point factory calibration. When temperature drift effects are to be included, *SLOPE* and *INTERCEPT* need to be determined at different operating temperatures and the system needs to incorporate a temperature sensor to determine which parameter values to use for the current operating temperature.

The logarithmic conformance error curves in the [Typical Performance Characteristics](#) section were obtained using linear regression applied to the response of the individual detector devices over -45 dBm to -10 dBm input power at  $T_A = 25^\circ\text{C}$ . The calculated *SLOPE* and *INTERCEPT* numbers are displayed in the tables under [Specifications](#).

At measurement temperatures other than  $T_A = 25^\circ\text{C}$ , the logarithmic response deviates slightly. A better measurement accuracy is achieved if detector response at the actual device temperature is used. The log conformance error deviation from  $T_A = 25^\circ\text{C}$ , the temperature drift error, equals:

$$\text{Temperature Drift Error} = \frac{V_{VLOG}(T) - V_{VLOG}(25^\circ\text{C})}{\text{SLOPE}(25^\circ\text{C})} \quad (5)$$

INPUT COUPLING OPTIONS

The internal 25 pF coupling capacitor of the ADL5507, along with the low frequency input impedance, gives a high-pass input corner frequency of approximately 4 MHz. This sets the minimum operating frequency. [Figure 84](#) to [Figure 86](#) show three options for input coupling. A broadband resistive match can be implemented by connecting a shunt resistor to ground at RFIN (see [Figure 84](#)). This 51 Ω resistor (other values can also be used to select different overall input impedance) combines with the input impedance of the ADL5507 to give a broadband input impedance of 50 Ω. While the input resistance and capacitance ( $R_{IN}$  and  $C_{IN}$ ) varies by a maximum of approximately ±20% from device to device, the dominance of the external shunt resistor means that the variation in the overall input impedance is close to the tolerance of the external resistor. Achieve better return loss by placing the 51 Ω shunt resistor as near the device under test (DUT) as possible.

A reactive match can also be implemented, as shown in [Figure 85](#). This is not recommended at low frequencies because device tolerances dramatically vary the quality of the match due to the large input resistance. For low frequencies, the option shown in [Figure 84](#) or [Figure 86](#) is recommended.

In [Figure 85](#), the matching components are drawn as general reactants. Depending on the frequency, the input impedance at that frequency and the availability of standard value components, either a capacitor or an inductor, is used. As in the previous case, the input impedance at a particular frequency is plotted on a Smith Chart and matching components are chosen (Shunt or Series L, or Shunt or Series C) to move the impedance to the center of

the chart. Matching components for specific frequencies can be calculated using the Smith Chart.

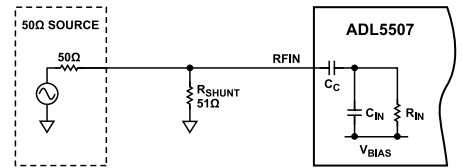

Figure 84. Broadband Resistive Method for Input Coupling

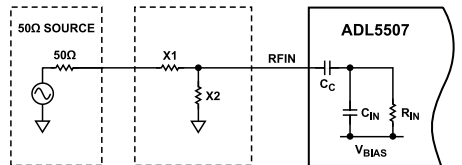

Figure 85. Narrow-Band Reactive Method for Input Coupling

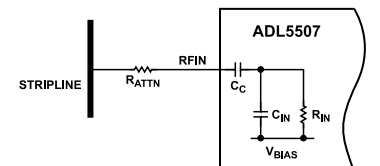

Figure 86. Series Attenuation Method for Input Coupling

[Figure 86](#) shows a third method for coupling the input signal into the ADL5507 in applications where the input signal is larger than the input range of the log amp. A series resistor, connected to the RF source, combines with the input impedance of the ADL5507 to resistively divide the input signal being applied to the input. This has the advantage of very little power being tapped off in RF power transmission applications.

Table 4. Input Impedance with 51 Ω Shunt for Select Frequency

Frequency (GHz)	S <sub>11</sub>		Impedance Ω (Series)
	Real	Imaginary	
0.01	-0.006	-0.009	49.35 - j0.85
0.1	-0.011	-0.006	48.88 - j0.60
0.5	-0.010	-0.026	48.90 - j2.57
1	-0.010	-0.054	48.72 - j5.27
2	-0.008	-0.113	47.96 - j11.01
3	-0.003	-0.179	46.64 - j17.30
4	+0.006	-0.250	44.67 - j23.79
5	+0.012	-0.323	41.49 - j29.90
6	-0.006	-0.392	36.30 - j33.57
7	-0.063	-0.464	29.04 - j34.48
8	-0.204	-0.504	20.67 - j29.59
9	-0.354	-0.545	13.55 - j25.59
10	-0.593	-0.459	7.98 - j16.70
11	-0.616	-0.326	9.45 - j12.01
12	-0.760	-0.274	5.48 - j8.64

## APPLICATIONS INFORMATION

**Table 4. Input Impedance with 51 Ω Shunt for Select Frequency (Continued)**

Frequency (GHz)	S <sub>11</sub>		Impedance Ω
	Real	Imaginary	(Series)
13	-0.731	-0.353	5.47 - j11.32
14	-0.545	-0.439	9.91 - j17.02
15	-0.609	-0.452	7.59 - j16.19

**Table 5. Raw Input Impedance for Select Frequency**

Frequency (GHz)	S <sub>11</sub>		Impedance Ω
	Real	Imaginary	(Series)
0.01	+0.925	-0.036	1024.75 - j518.10
0.1	+0.908	-0.028	941.18 - j301.57
0.5	+0.901	-0.114	384.78 - j498.60
1	+0.876	-0.222	141.67 - j343.22
2	+0.785	-0.415	48.43 - j189.73
3	+0.666	-0.566	27.38 - j131.03
4	+0.545	-0.672	19.07 - j101.97
5	+0.421	-0.750	14.47 - j83.55
6	+0.252	-0.788	13.33 - j66.74
7	+0.070	-0.810	11.13 - j53.25
8	-0.165	-0.761	10.18 - j39.28
9	-0.336	-0.671	9.75 - j30.03
10	-0.564	-0.524	7.50 - j19.27
11	-0.548	-0.356	11.37 - j14.11
12	-0.752	-0.262	5.84 - j8.34
13	-0.697	-0.375	6.18 - j12.43
14	-0.498	-0.365	13.01 - j15.34
15	-0.673	-0.344	7.35 - j11.81

### FILTER CAPACITOR

The video bandwidth of VLOG is approximately 3.5 MHz. In CW applications where the input frequency is much higher than this, no further filtering of the demodulated signal is required. Where there is a low frequency modulation of the carrier amplitude, however, reduce the low-pass corner by the addition of an external filter capacitor, C<sub>FILT</sub>. The video bandwidth is related to C<sub>FILT</sub> by

$$\text{Video Bandwidth} = \frac{1}{2\pi \times 12 \text{ k}\Omega \times (3.65 \text{ pF} + C_{FILT})} \quad (6)$$

### VLOG PULSE RESPONSE TIME

The ADL5507 VLOG output response for rise and fall times to a given RF input pulse is quickest for C<sub>FILT</sub> = open; that is, the only capacitance on the CFLT node is the internal capacitor. Adding off-chip capacitance from the CFLT pin to the VLOG pin decreases the video bandwidth and slows the output response to an RF input pulse. See the [Filter Capacitor](#) section for an approximate closed form equation for the VLOG video bandwidth.

### VLOG OUTPUT NOISE

The ADL5507 VLOG output noise for Positive Slope mode is shown in [Figure 37](#) and for Negative Slope mode is shown in [Figure 72](#) in the [Typical Performance Characteristics](#) section for Capacitor C<sub>FILT</sub> = open. Placing capacitance from CFLT to VLOG decreases the noise spectral density and the integrated noise. The choice of the C<sub>FILT</sub> value depends on the requirements pertaining to integrated noise and noise spectral density at a given frequency. Also, the value of C<sub>FILT</sub> directly controls the video bandwidth of the output, and thus controls the output response time to an RF pulse (see the [VLOG Pulse Response Time](#) section).

### EFFECT OF WAVEFORM TYPE ON INTERCEPT

Although, specified for input levels in decibels relative to 1 mW (dBm), the ADL5507 fundamentally responds to voltage and not to power. A direct consequence of this characteristic is that input signals of equal RMS power but differing crest factors, produce different results at the output of the log amplifier.

The effect of differing signal waveforms is to shift the effective value of the intercept upwards or downwards. Graphically, this looks like a vertical shift in the transfer function of the log amplifier. The logarithmic slope, however, is not affected. For example, consider the case of the ADL5507 being alternately fed by an unmodulated sine wave and by a 64 QAM signal of the same RMS power. The output voltage of the ADL5507 differs by the equivalent of 1.6 dB (31 mV) over the complete dynamic range of the device (with the output for a 64 QAM input being lower).

### DEVICE HANDLING

The WLCSP package consists of solder bumps connected to the active side of the die. The device is lead-free with 95.5% tin, 4.0% silver, and 0.5% copper solder bump composition. The WLCSP package can be mounted on printed circuit boards using standard surface-mount assembly techniques; however, take caution to avoid damaging the die. See the [AN-617 Application Note](#) for additional information. WLCSP devices are bumped die, and exposed die can be sensitive to light conditions, which can influence specified limits.



EVALUATION BOARD

Figure 87 shows the schematic of the ADL5507 evaluation board. The board is powered by a single supply in the 2.7 V to 3.45 V range. The power supply is decoupled by 100 pF and 0.1 μF capacitors. Enable the device in positive slope mode by placing a jumper at EN location of jumper block P1. Remove the jumper completely to enable the device in negative slope mode.

The RF input has a broadband match of 50 Ω using a single 51 Ω resistor at R1A. More precise matching at spot frequencies is possible (see the Input Coupling Options section).

Figure 88 and Figure 89 shows the layout of the evaluation board.

LAND PATTERN AND SOLDERING INFORMATION

Pad diameters of 8 mils are recommended with a solder mask opening of 12 mils. The RF input trace is a grounded coplanar waveguide (GCPW) with a trace width of 28.5 mils and a gap width of 10 mils, which corresponds to a 50 Ω characteristic impedance for the dielectric material being used (RO4003C). All traces going to the pads are tapered down to 5 mils. For the RFIN line, the length of the tapered section is 25 mils.

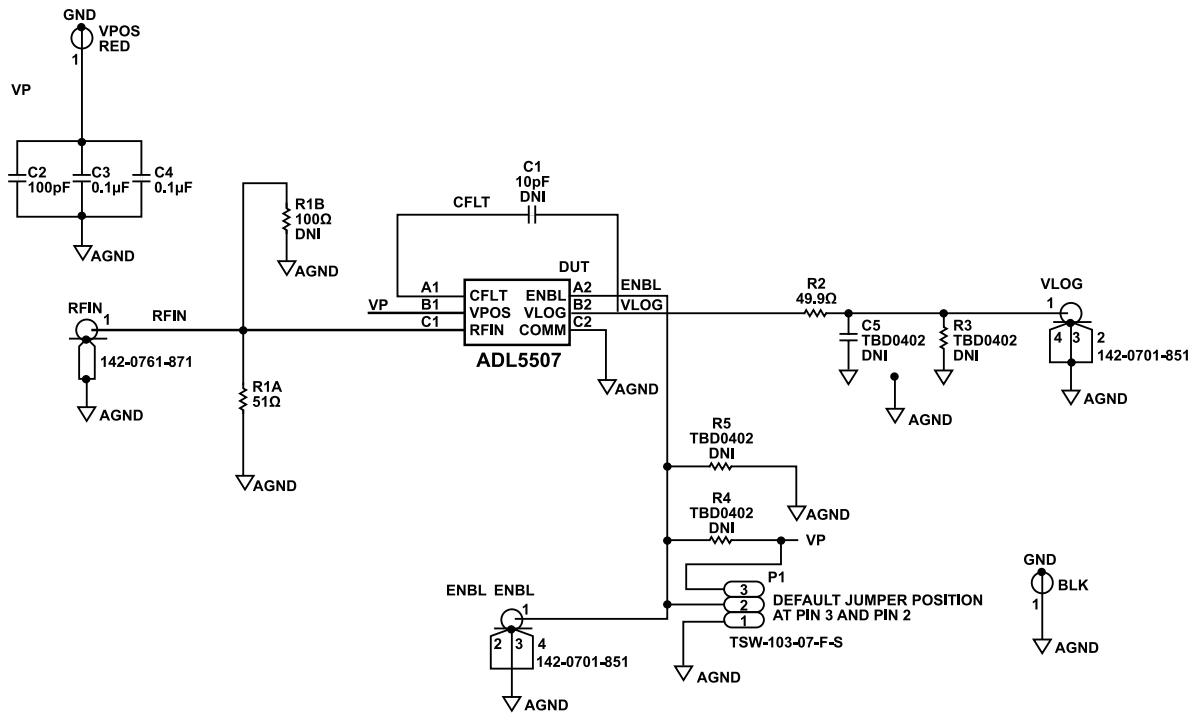
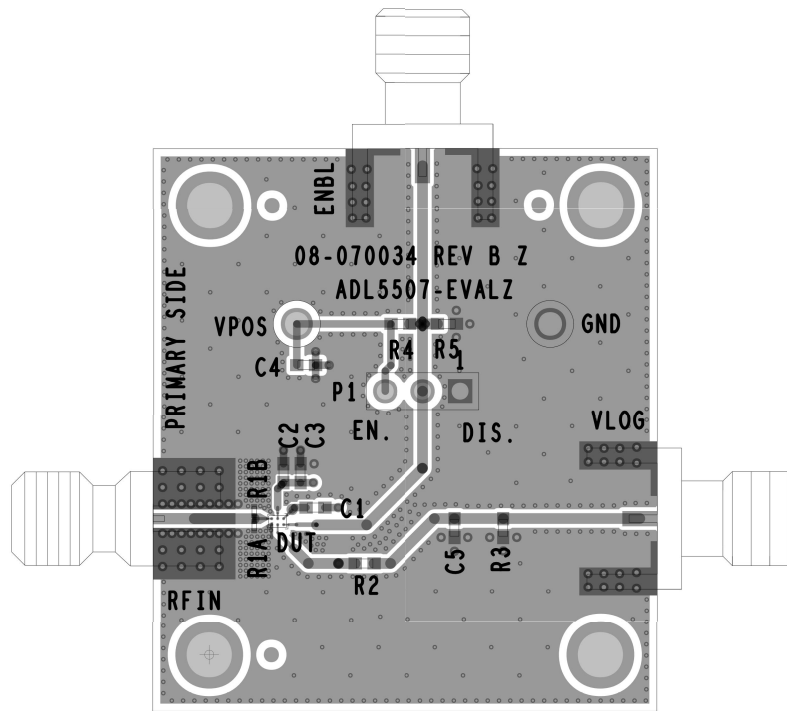

Figure 87. Evaluation Board Schematic

085



EVALUATION BOARD



086

Figure 88. Primary Side of the Evaluation Board

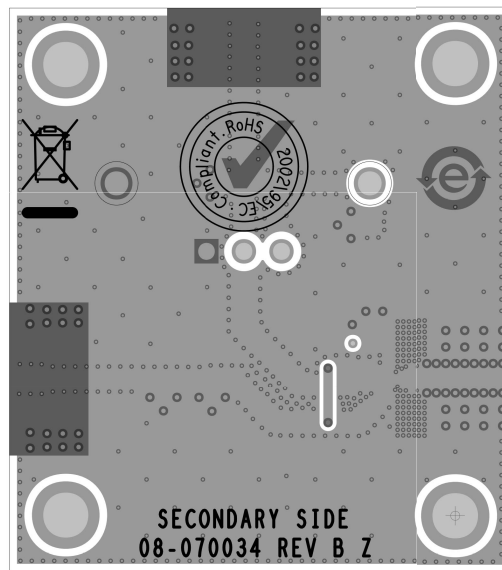

087

Figure 89. Secondary Side of the Evaluation Board

OUTLINE DIMENSIONS

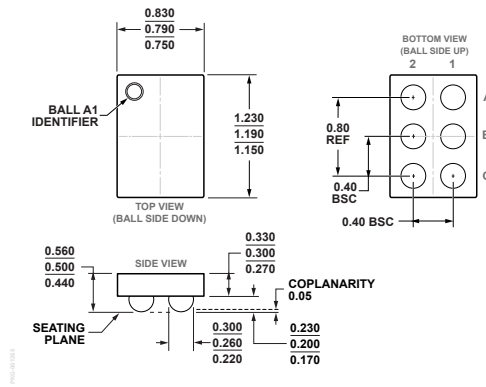

Figure 90. 6-Ball WLCSP  
(CB-6-14)  
Dimensions Shown in millimeters

Updated: November 29, 2023

ORDERING GUIDE

Model <sup>1</sup>	Temperature Range	Package Description	Packing Quantity	Package Option
ADL5507ACBZ	-40°C to +105°C	6-Ball WLCSP (1.2mm x 0.8mm)	10	CB-6-14
ADL5507ACBZ-R7	-40°C to +105°C	6-Ball WLCSP (1.2mm x 0.8mm)	Reel, 3000	CB-6-14

<sup>1</sup> Z = RoHS Compliant Part.

EVALUATION BOARDS

Model <sup>1</sup>	Description
ADL5507-EVALZ	Evaluation Board

<sup>1</sup> Z = RoHS-Compliant Part.