



ENGLISH

Datasheet

RS Speaker Driver, 0.2W nom, 8Ω

RS Stock 628-4535

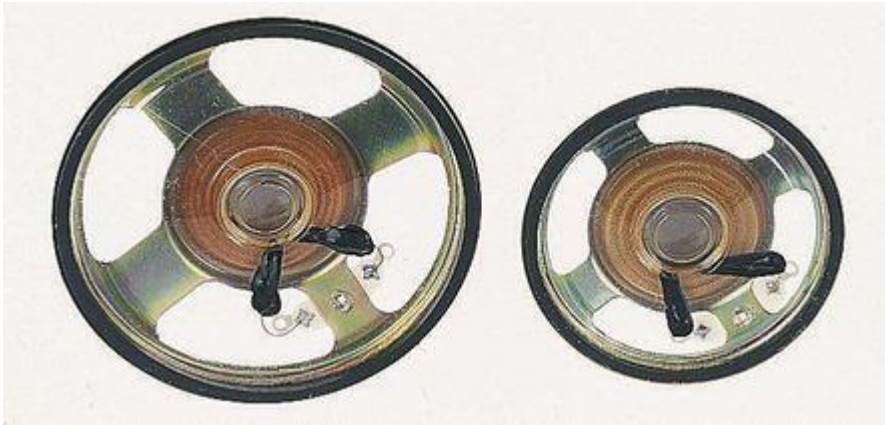

Dimensions: (mm)

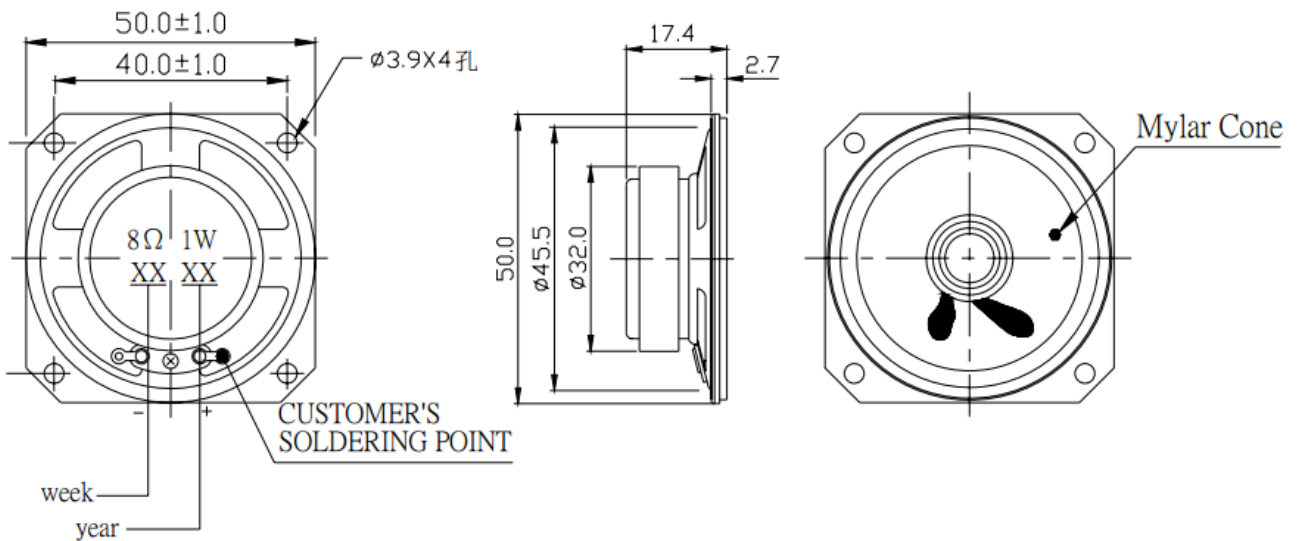

Tol: ± 0.5

Unit : mm