

Datasheet

RS Pro Solenoid Valve 2 Port, NC, 230v AC/DC, 3/4" BSP Inlet, 90° DN10 Outlet

RS Stock No: 1904142

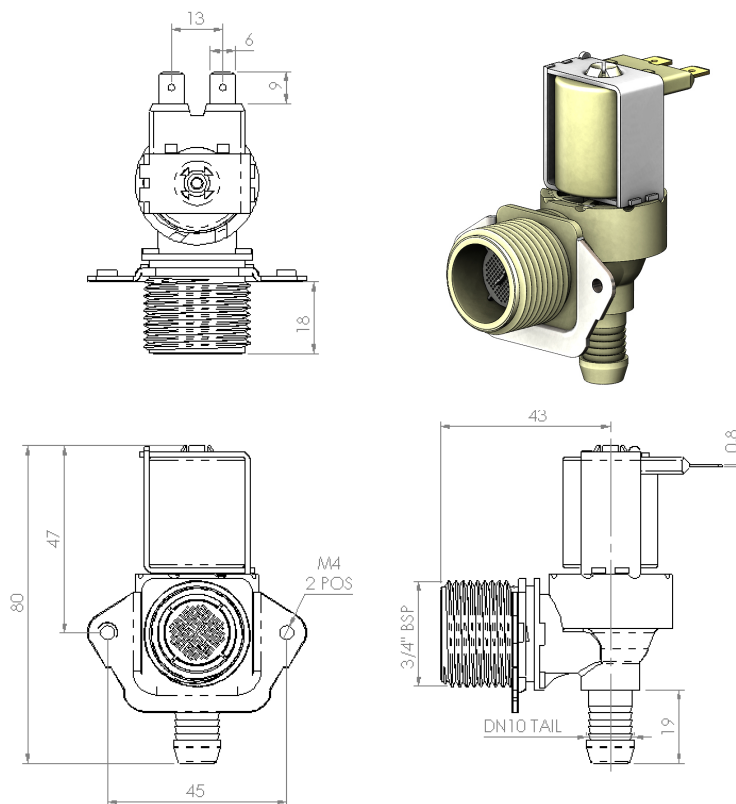

SPECIFICATIONS:	
VOLTAGE:	230V
FREQUENCY:	AC/DC
POWER DRAW:	5w
COIL INSULATION:	CLASS F (140°C OPERATING TEMPERATURE)
AMBIENT TEMPERATURE:	60°C Max
MEDIUM:	Potable water 90° Max
DUTY CYCLE 100%:	Tu 60°C, Tm 25°C
DUTY CYCLE:	3min ON / 5min Off - Tu 60°C, Tm 90°C
OPERATING PRESSURE:	0.2 - 10 Bar
EMC:	Fully Compliant
APPROVALS:	EN 60 730-2-8, WRAS, ACS.
TERMINALS:	6mm x 0.8mm Male tab terminals (x2)