



ENGLISH

Datasheet

RS Pro Carbide Tipped Dead Centre

RS Stock No: 136-8079

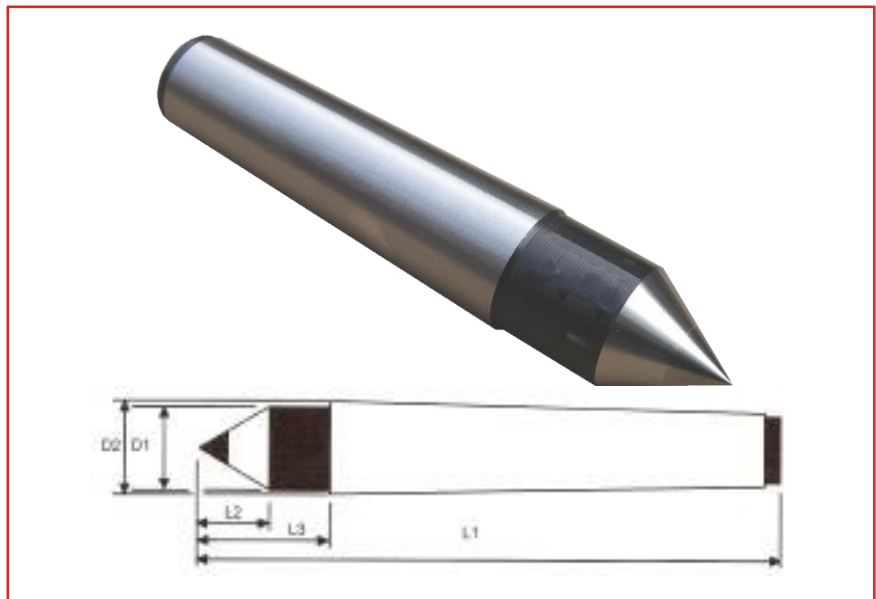

Specifications:

DIN 806

Point 60°

Material: K30

Hardness 80 – 90 HRC

Code	MT no	L1	L2	L3	D1	D2
136-8079	MT 1	80	10	23	12	12.0

Order Code	Manufacturers Code	Product Description
136-8079		Carbide Tipped Dead Centre



ENGLISH

Datasheet

RS Pro Micrometer Checking Gauge Block Set

The individual gauge block sizes included in this set have been selected to check the accuracy of the micrometer spindle and measuring faces in 5 different rotational positions between 0 and 25mm. Ensuring the accuracy of both the screw and parallelism of the contact faces

Set Type	Set Size	Sizes in Set
Metric	11 Piece	3.1mm, 6.5mm, 9.7mm, 12.5mm, 15.8mm, 19.0mm, 21.9mm, 25mm, 50mm, 75mm, & 100mm

UKAS Calibration Certificates:

These sets are supplied complete with a UKAS Calibration Certificate issued by an approved Laboratory

The Calibration Certificate issued by the Laboratory indicates the date the set was originally calibrated

The calibrated set is deemed to be in isolation until it is sold to the eventual user as there will be no wear or change due to use

The eventual user should record the date of purchase and invoice number to establish when the instrument was first put into use

This date becomes the reference point and is used together with the frequency of the sets use to determine future recalibration dates

Care and Use:

Always clean gauge blocks following their use

Wipe with a soft cloth or chamois avoiding direct finger contact with the gauge block

Replace the blocks in the case whilst still holding them with the cleaning cloth

When not in use the blocks should be coated with a rust preventative applied with a soft cloth

Return the coated blocks to their case whilst holding them with the cloth

Before use the blocks can be cleaned with a mineral spirit which will leave slight oily film on their surface and help prevent short term corrosion

The film left by the mineral spirit will not affect the use of the blocks



ENGLISH

Datasheet

RS Pro Micrometer Checking Gauge Block Set

Care and Use:

Blocks can be cleaned with alcohol however this will leave the blocks so clean they will be more susceptible to corrosion

When using alcohol take the necessary precaution as this can cause a fire hazard

Check blocks for burrs and nicks prior to wringing together

Do not leave blocks wrung together over night as this can cause damage to their surfaces when eventually parted

Be careful when handling blocks, do not drop or assemble above the open case as this will cause damage

Check that the instrument or equipment to be checked or set with the blocks for any burrs or nicks which may damage the blocks and cause incorrect readings during the procedure.

Size Range Stated in mm	Grade 2 Limit deviation of length at any point from nominal length Stated in microns	Grade 2 Tolerance for the variation in length Stated in microns
0 - 10	0.45	0.3
10 – 25	0.6	0.3
25 – 50	0.8	0.3
50 – 75	1.0	0.35
75 - 100	1.2	0.35