

Datasheet

RS PRO - Aluminium Enclosure - 160 x 108.5 x 45 - Black

Stock number: 195-1521

EN



Features:

- Black anodised extruded box section to take 100 x 160mm circuit boards
- The maximum height of components on a board in the bottom slot is 33.6mm
- The box features dovetail slots down the side which accept a mounting bracket for surface mounting
- Supplied in kit form

Kit Contents:

- 1 x Aluminium Extruded Case
- 2 x Aluminium End Plates
- 8 x No4 x 3/8 Plastite screws

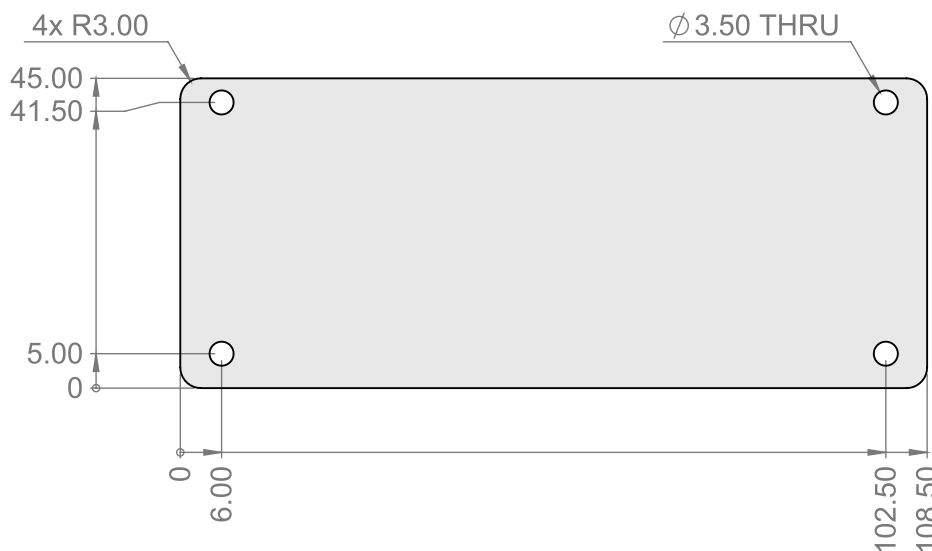
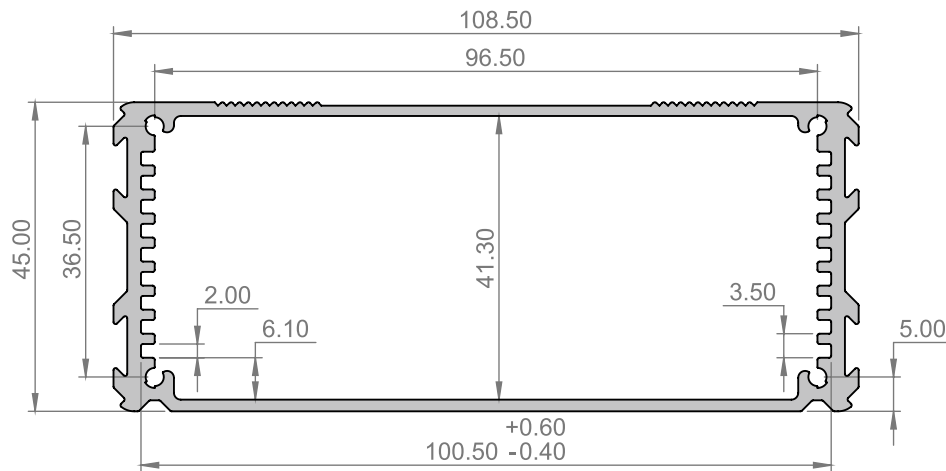



Datasheet

Product Description:

RS PRO - Aluminium Enclosure - 160 x 108.5 x 45 - Black

Brought to you by RS Pro, a range of high quality, robust and versatile extruded aluminium enclosures designed for housing electronics. These enclosures feature integral card slots for easy PCB mounting. All sizes are supplied in a Silver or Black anodised finish. Available with optional mounting lugs.

Specifications:

	Case	End Plates	Screws
Material	Aluminium 6063	Aluminium 5005	Steel
Finish	Black Anodised	Black Anodised	Black
Weight	285.4g	20g (each)	4.9g (8 screws)