

Datasheet

Cylinder Cam Lock with Wing Knob

RS Stock No:146-1794

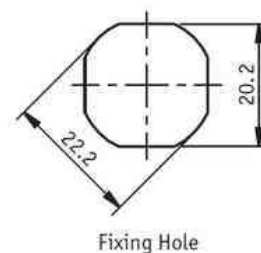
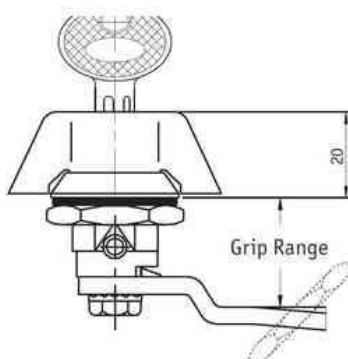

Specification

Die-cast Zinc alloy over moulded with
Black Polyamide

Supplied with 2 standard Euro Keys (5333)



ENGLISH

Part Number	Grip Range
146-1794	8.5
146-1797	14.5
146-1795	26.5
146-1798	28.5

All dimensions in mm