

EasyLogic™ PM2100 series

User Manual

NHA2779002-10
05/2022



Legal Information

The Schneider Electric brand and any trademarks of Schneider Electric SE and its subsidiaries referred to in this guide are the property of Schneider Electric SE or its subsidiaries. All other brands may be trademarks of their respective owners.

This guide and its content are protected under applicable copyright laws and furnished for informational use only. No part of this guide may be reproduced or transmitted in any form or by any means (electronic, mechanical, photocopying, recording, or otherwise), for any purpose, without the prior written permission of Schneider Electric.

Schneider Electric does not grant any right or license for commercial use of the guide or its content, except for a non-exclusive and personal license to consult it on an "as is" basis. Schneider Electric products and equipment should be installed, operated, serviced, and maintained only by qualified personnel.

As standards, specifications, and designs change from time to time, information contained in this guide may be subject to change without notice.

To the extent permitted by applicable law, no responsibility or liability is assumed by Schneider Electric and its subsidiaries for any errors or omissions in the informational content of this material or consequences arising out of or resulting from the use of the information contained herein.

Safety information

Important information

Read these instructions carefully and look at the equipment to become familiar with the device before trying to install, operate, service, or maintain it. The following special messages may appear throughout this manual or on the equipment to warn of potential hazards or to call attention to information that clarifies or simplifies a procedure.



The addition of either symbol to a “Danger” or “Warning” safety label indicates that an electrical hazard exists which will result in personal injury if the instructions are not followed.



This is the safety alert symbol. It is used to alert you to potential personal injury hazards. Obey all safety messages that accompany this symbol to avoid possible injury or death.

DANGER

DANGER indicates a hazardous situation which, if not avoided, **will result in** death or serious injury.

Failure to follow these instructions will result in death or serious injury.

WARNING

WARNING indicates a hazardous situation which, if not avoided, **could result in** death or serious injury.

CAUTION

CAUTION indicates a hazardous situation which, if not avoided, **could result in** minor or moderate injury.

NOTICE

NOTICE is used to address practices not related to physical injury.

Please note

Electrical equipment should be installed, operated, serviced and maintained only by qualified personnel. No responsibility is assumed by Schneider Electric for any consequences arising out of the use of this material. A qualified person is one who has skills and knowledge related to the construction, installation, and operation of electrical equipment and has received safety training to recognize and avoid the hazards involved.

Notices

FCC

This equipment has been tested and found to comply with the limits for a Class A digital device, pursuant to Part 15 of the FCC rules. These limits are designed to provide reasonable protection against harmful interference when the equipment is operated in a commercial environment. This equipment generates, uses, and can radiate radio frequency energy and, if not installed and used in accordance with the instruction manual, may cause harmful interference to radio communications. Operation of this equipment in a residential area is likely to cause harmful interference in which case the user will be required to correct the interference at his own expense.

The user is cautioned that any changes or modifications not expressly approved by Schneider Electric could void the user's authority to operate the equipment.

This digital apparatus complies with CAN ICES-3 (A) /NMB-3(A).

Table of Contents

Safety precautions	9
Introduction	10
Meter Overview	10
Meter Features	10
Feature summary	10
Mounting adaptors	12
Measured parameters	12
Energy	12
Demand	12
Instantaneous	12
Power quality	13
Data recording	13
Other measurements	13
Data display and analysis tools	13
Power Monitoring Expert	13
Power SCADA Operation	14
Meter configuration	14
Hardware references	15
PM2100 meter models and accessories	15
Supplemental information	15
Panel Meter	15
LED Indicators	16
Meter mounting	16
Meter wiring	17
Direct connect voltage limits	17
Balanced system considerations	19
Serial communications	19
RS-485 wiring	19
Pulse output	20
Display and meter setup	21
Display overview	21
LED Indicators	21
Alarm / energy pulsing LED	22
Heartbeat / serial communications LED	22
Button functions	22
Meter screen menus	23
Display screen menus	23
Setup screen menus	25
Demand	31
Communications setup	32
Setting up the password	33
Setting up date and time	34
Diagnostics (Diag) screen menus	34
Clear screen menus	36
Lock / Unlock	37
Remote meter setup	39
Overview	39

ION setup	39
RS-485 port setup	39
Meter setup through RS-485	39
Meter configuration using ION setup	39
Viewing meter data	40
Viewing meter data from the display	40
Using ION Setup to view or modify configuration data	41
Using software to view meter data	41
Power Monitoring Expert	42
Power SCADA Operation	42
Modbus command interface	42
I/O Modules.....	43
Analog input applications	43
Analog output applications	45
Status input (DI) applications	47
Digital output applications	48
Relay output applications	49
IO LED Indicator	51
Alarms.....	52
Alarms overview	52
Alarm types	52
Unary alarms.....	52
Available unary alarms	52
Digital alarms	53
Available digital alarms	53
Standard alarms	53
Example of over and under setpoint (standard) alarm operation.....	54
Maximum allowable setpoint	55
Available standard alarms	55
Alarm priorities	57
Alarm setup overview.....	57
LED alarm indicator	60
Configuring the LED for alarms using ION Setup	60
Alarms counters	60
Meter logging.....	61
Logs overview	61
Setting up the data log	61
Saving the data log contents using ION Setup	61
Alarm log	62
Meter resets.....	63
Meter resets.....	63
Meter initialization.....	63
Performing resets using ION Setup	63
Measurements and calculations	65
Real-time readings	65
Energy measurements	65
Quadrant based VARh	65
Min/max values	65
Power demand	66
Power demand calculation methods	66

Block interval demand	66
Synchronized demand.....	67
Thermal demand	68
Current demand	68
Predicted demand.....	68
Peak demand	69
Timer	69
Power quality	70
Harmonics overview	70
Total harmonic distortion %.....	70
Harmonic content calculations	70
THD% calculations.....	70
Displaying harmonics data	70
Maintenance and upgrades.....	72
Maintenance overview	72
Troubleshooting LED indicators	72
Meter memory	72
Meter battery	73
Viewing firmware version, model and serial number	73
Firmware upgrades.....	73
Technical assistance.....	73
Verifying accuracy.....	74
Overview of meter accuracy	74
Accuracy test requirements	74
Verifying accuracy test	75
Required pulses calculation for accuracy verification testing	76
Total power calculation for accuracy verification testing	77
Percentage error calculation for accuracy verification testing	77
Accuracy verification test points.....	77
Energy pulsing considerations	78
VT and CT considerations.....	78
Example calculations	79
Typical sources of test errors	80
Power and power factor	81
Power and power factor	81
Current phase shift from voltage	81
Real, reactive and apparent power (PQS).....	81
Power factor (PF)	82
Power factor sign convention	83
Power factor min/max convention.....	84
Power factor register format.....	84
Specifications	87
China Standard Compliance	92

Safety precautions

Installation, wiring, testing and service must be performed in accordance with all local and national electrical codes.

⚠️⚠️ DANGER

HAZARD OF ELECTRIC SHOCK, EXPLOSION, OR ARC FLASH

- Apply appropriate Personal Protective Equipment (PPE) and follow safe electrical work practices. See NFPA 70E, CSA Z462 or other local standards.
- Turn off all power supplying this device and the equipment in which it is installed before working on or in the equipment.
- Always use a properly rated voltage sensing device to confirm that all power is off.
- Follow guidelines in the Wiring section of the related Installation Sheet.
- Assume communications and I/O wiring are hazardous live until determined otherwise.
- Do not exceed the maximum ratings of this device.
- Do not short secondary terminals of Voltage Transformer (VT).
- Do not open secondary terminals of Current Transformer (CT).
- Ground secondary circuit of CTs.
- Do not use the data from the meter to confirm power is off.
- Replace all devices, doors and covers before turning on power to this equipment.

Failure to follow these instructions will result in death or serious injury.

NOTE: See IEC 60950-1 for more information on communications and I/O wiring connected to multiple devices.

⚠️ WARNING

UNINTENDED OPERATION

- Do not use this device for critical control or protection of persons, animals, property or equipment.

Failure to follow these instructions can result in death, serious injury, or equipment damage.

⚠️ WARNING

POTENTIAL COMPROMISE OF SYSTEM AVAILABILITY, INTEGRITY, AND CONFIDENTIALITY

- Change default passwords/passcodes to help prevent unauthorized access to device settings and information.
- Disable unused ports/services and default accounts, where possible, to minimize pathways for malicious attacks.
- Place networked devices behind multiple layers of cyber defenses (such as firewalls, network segmentation, and network intrusion detection and protection).
- Use cybersecurity best practices (for example: least privilege, separation of duties) to help prevent unauthorized exposure, loss, modification of data and logs, interruption of services, or unintended operation.

Failure to follow these instructions can result in death, serious injury, or equipment damage.

Introduction

Meter Overview

The PM2100 series meters are digital meters that offer comprehensive 3-phase electrical instrumentation and load management facilities in a compact and rugged package.

The meters offer value for the demanding needs of your energy monitoring and cost management applications. All meters in the PM2100 series range comply with Class 1, or Class 0.5S accuracy standards and feature high quality, reliability and affordability in a compact and easy to install format.

Meter Features

The PM2100 series meter supports many features, a few of the features are listed below:

- LED display screen: Intuitive self-guided navigation using three buttons LED display, with three lines of concurrent values. Two columns of LEDs given on the either side of the meter's front panel indicate the parameter name being displayed.
- Energy accounting and balancing
- Measurement of both True PF and Displacement PF
- Active, reactive, and apparent energy readings
- Min/Max values of instantaneous parameters with timestamp.
- Cybersecurity: The meter supports the disabling of RS-485 port through front panel keys to prevent unauthorized access. Toggle the RTU devices in case of limited availability of nodes in software system.
- Suppression current: The meter can be configured to disregard the measurement of induced / auxiliary load current in the circuit (can be set from 5 to 99 mA).

You can use the meter as a stand-alone device, but its extensive capabilities are fully realized when used as part of an energy management system.

For applications, feature details and the most current and complete specifications of the PM2100 meters, see the EasyLogic PM2000 series technical datasheet at www.se.com.

Feature summary

Parameter	PM2110	PM2120	PM2130
Accuracy Class for Wh	Class 1	Class 1	Class 0.5S
Accuracy Class for VARh	1.0	1.0	1.0
Sampling rate per cycle	64	64	64
Current: <ul style="list-style-type: none"> • Per-phase and 3 phase average • Calculated neutral current 	✓	✓	✓
Voltage: <ul style="list-style-type: none"> • V L-N - per-phase and 3 phase average • V L-L - per-phase and 3 phase average 	✓	✓	✓

Parameter	PM2110	PM2120	PM2130
Power Factor <ul style="list-style-type: none"> Per phase and 3 phase total 	True PF	True PF Displacement PF ¹	True PF Displacement PF ¹
Frequency	✓	✓	✓
Power: <ul style="list-style-type: none"> Active power (kW) - Phase wise and total Apparent power (kVA) - Phase wise and total Reactive power (kVAR) - Phase wise and total 	✓	✓	✓
3 Phase unbalance	Current	Current Voltage ¹	Current Voltage ¹
Demand parameters (kW, kVA, kVAR, I) <ul style="list-style-type: none"> Last demand Present demand Predictive demand Peak demand: Timestamp for peak demand ¹ 	✓ (no timestamp)	✓	✓
Energy: kWh, kVAh, kVARh (4 Quadrant) <ul style="list-style-type: none"> Delivered (Import / Forward) Received (Export / Reverse) 	Delivered Received	Delivered Received Total ¹ Net ¹ Last cleared (Old) ¹	Delivered Received Total ¹ Net ¹ Last cleared (Old) ¹
Meter On hours Load Run hours Power Interruptions	✓	✓	✓
THD: <ul style="list-style-type: none"> Voltage L-N per phase Voltage L-L per phase Current per phase 	✓	✓	✓
Individual Harmonics ¹	—	Up to 15th individual harmonics	Up to 31st individual harmonics
Min / Max with timestamp ¹ <ul style="list-style-type: none"> V L-L average V L-N average Current average Frequency Active power, Total Apparent power, Total Reactive power, Total Power factor, Total 	—	✓	✓
RTC	—	✓	✓
Communication	POP	RS-485 Modbus RTU	RS-485 Modbus RTU
Expandable Analog IO modules (1 input & 1 output)	—	—	✓
Expandable Analog IO modules (2 inputs & 2 outputs)	—	—	✓
Expandable Digital IO modules (2 inputs & 2 outputs)	—	—	✓
Expandable Relay Output modules (2 digital input & 2 relay output)	—	—	✓

1. Indicates features that can be read through communication only

Parameter	PM2110	PM2120	PM2130
Data Logging <ul style="list-style-type: none"> Energy (W, VA, VAR): Delivered / Received Power: Active / Apparent / Reactive (total) Demand (W, VA, VAR, A): Last 	—	—	✓
Retrofit (RtFt) For configuring legacy communication data models	—	✓	✓

Mounting adaptors

There are different mounting adaptor accessories that can help when installing your meter in existing panels and cutouts where the default mounting hardware is not appropriate.

Mounting adaptor kits are ordered separately from the meter.

Measured parameters

Energy

The meter provides bi-directional, 4-quadrant, Class 1 / Class 0.5S accurate energy metering.

The meter stores all accumulated active, reactive, and apparent energy parameters in nonvolatile memory:

- kWh, kVARh, kVAh (delivered)
- kWh, kVARh, kVAh (received)
- kWh, kVARh, kVAh (delivered + received)
- kWh, kVARh, kVAh (delivered - received)

All energy parameters represent the total for all three phases.

NOTE: Based on the energy scale selection, when kWh, kVARh, kVAh (delivered) or kWh, kVARh, kVAh (received) of the energy parameters overflow at 999999999.999 all energy parameter value resets.

Demand

The meter provides last, present, predicted, and maximum (peak) demand values, and a timestamp when the maximum (peak) demand occurred.

The meter supports standard demand calculation methods, including sliding block, fixed block, rolling block, thermal and synchronized.

Peak demand registers can be reset manually (password protected).

Demand measurements include:

- W, VAR, VA demand total
- Amps demand average

Instantaneous

The meter provides highly accurate 1-second measurements, average values, including true RMS, per phase and total for:

- Per phase and average voltage (line-to-line, line-to-neutral)
 - Per phase and average current, and neutral current
- NOTE:** Neutral current is calculated.
- Per phase and total power (VA, W, Var)
 - Per phase and average for true and displacement power factor
 - System frequency
 - Per phase and maximum of all three for voltage unbalance and current unbalance

Power quality

The meter provides complete harmonic distortion measurement, recording, and real-time reporting, up to the 15th harmonic for PM2120 and up to 31st harmonic for PM2130 for all voltage and current inputs.

The following power quality measurements are available:

- PM2120: Individual odd harmonics up to 15th order (Voltage and current, per phase)
- PM2130: Individual odd harmonics up to 31st order (Voltage and current, per phase)
- Total harmonic distortion (THD%) for current and voltage (displays line-to-line or line-to-neutral, based on selected system configuration)

Data recording

The meter stores each new minimum and new maximum value with date and timestamp for all instantaneous values (average, total, and each phase).

Other measurements

Additional measurements recorded by the meter include several timers.

These timers include:

- I/O timer displays the powered ON duration of the input or output.
- Operating timer displays the powered ON duration of the meter.
- Active load timer displays the duration of the connected load, based on the specified minimum current for the load timer setpoint setting.

Data display and analysis tools

Power Monitoring Expert

EcoStruxure™ Power Monitoring Expert is a complete supervisory software package for power management applications.

The software collects and organizes data gathered from your facility's electrical network and presents it as meaningful, actionable information via an intuitive web interface.

Power Monitoring Expert communicates with devices on the network to provide:

- Real-time monitoring through a multi-user web portal
- Trend graphing and aggregation

- Power quality analysis and compliance monitoring
- Preconfigured and custom reporting

See the EcoStruxure™ Power Monitoring Expert online help for instructions on how to add your device into its system for data collection and analysis.

Power SCADA Operation

EcoStruxure™ Power SCADA Operation is a complete real-time monitoring and control solution for large facility and critical infrastructure operations.

It communicates with your device for data acquisition and real-time control. You can use Power SCADA Operation for:

- System supervision
- Real-time and historical trending, event logging
- PC-based custom alarms

See the EcoStruxure™ Power SCADA Operation online help for instructions on how to add your device into its system for data collection and analysis.

Meter configuration

Meter configuration is performed through the display or through PowerLogic™ ION Setup.

ION Setup is a meter configuration tool that can be downloaded for free at www.se.com.

See the *EasyLogic PM2000 Series Power Meter* in the ION Setup online help or in the *ION Setup device configuration guide*. To download a copy, go to www.se.com and search for *ION Setup device configuration guide*.

Hardware references

PM2100 meter models and accessories

The PM2100 series meter is available in one physical form factor and three different variants.

Meter models

Model	Commercial reference	Description
PM2110	METSEPM2110	Class 1 panel mount LED meter with pulse output.
PM2120	METSEPM2120	Class 1 panel mount LED meter with RS-485 communication and odd harmonics up to 15 th order.
PM2130	METSEPM2130	Class 0.5S panel mount LED meter with RS-485 communication and odd harmonics up to 31 st order with IO support and data log and alarms.

Meter accessories

Model	Commercial reference	Description
2 Channel Digital Input Output Module	METSEPM2KDGTLIO22 and METSEPM2KDGTLIO22D	Digital I/O module with 2 channel input and output.
2 Channel Analog Input Output Module	METSEPM2KANLGIO22 and METSEPM2KANLGIO22D	Analog I/O module with 2 channel input and output.
1 Channel Analog Input Output Module	METSEPM2KANLGIO11 and METSEPM2KANLGIO11D	Analog I/O module with single channel input and output.
2 Channel Digital Input and Relay Output Module	METSEPM2K2DI2RO and METSEPM2K2DI2ROD	Relay Output with 2 channel digital input and relay output.

NOTE: The I/O modules are supported by PM2130 meter models only.

See the PM2000 series catalog pages, available from www.se.com, or consult your local Schneider Electric representative for information about mounting adapters available for your meter.

Supplemental information

This document is intended to be used in conjunction with the installation sheet that ships in the box with your device and accessories.

See your device's installation sheet for information related to installation.

See your product's catalog pages at www.se.com for information about your device, its options and accessories.

You can download updated documentation from www.se.com or contact your local Schneider Electric representative for the latest information about your product.

Panel Meter

The back of your meter supports various power system connections.

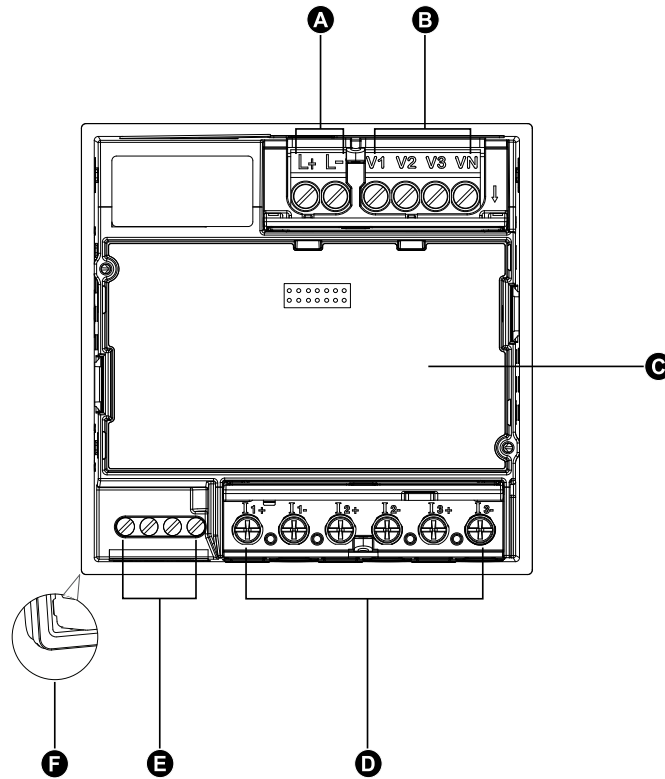

A	Auxiliary power supply (control power) terminals (L+, L-)
B	Input voltage terminals (V1, V2, V3, VN)
C	Optional I/O Slot (Only for PM2130)
D	Input current terminals (I1+, I1-, I2+, I2-, I3+, I3-)
E	RS-485 communications (D0, D1, SHLD, 0V) / POP terminals (D1+, D1-)
F	Gasket

LED Indicators

The LED indicators alert or inform you of meter activity.

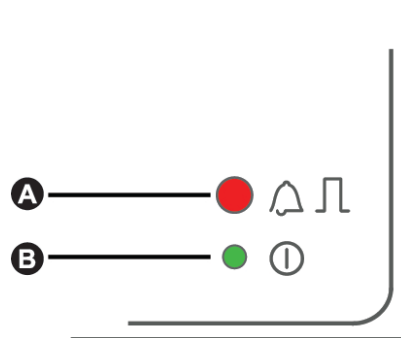

A	Alarms / Energy pulsing LED (Red)
B	Heartbeat / serial communications LED (Green)

Meter mounting

For mounting instructions and safety precautions, see the installation sheet that was shipped with your device

You can also download the latest copy at www.se.com.

Meter wiring

For wiring instructions and safety precautions, see the meter installation sheet that was shipped with your meter.



You can also download the latest copy at www.se.com.

Direct connect voltage limits

You can connect the meter's voltage inputs directly to the phase voltage lines of the power system if the power system's line-to-line or line-to-neutral voltages do not exceed the meter's direct connect maximum voltage limits.

The meter's voltage measurement inputs are rated by the manufacturer for up to 277 V L-N / 480 V L-L. However, the maximum voltage allowed for direct connection may be lower, depending on the local electrical codes and regulations. As per installation category II / III the maximum voltage on the meter voltage measurement inputs should not exceed 277 V L-N / 480 V L-L for CAT III and 347 V L-N / 600 V L-L for CAT II.

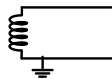
If your system voltage is greater than the specified direct connect maximum voltage, you must use VTs (voltage transformers) to step down the voltages.

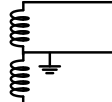
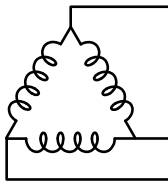
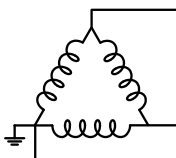
Power system description	Meter setting		Symbol	Direct connect maximum (UL / IEC)		# of VTs (if required)
	Display (meter)	Display (communication)		Installation category III	Installation category II	
Single-phase 2-wire line-to-neutral	1P.LN	1PH 2Wire L-N		≤ 277 V L-N	≤ 347 V L-N	1 VT
Single-phase 2-wire line-to-line	1P.LL	1PH 2Wire L-L		480 V L-L	600 V L-L	1 VT
Single-phase 3-wire line-to-line with neutral	1P.3L	1PH 3Wire L-L with N		≤ 277 V L-N / 480 V L-L	≤ 347 V L-N / 600 V L-L	2 VT
3-phase 3-wire Delta ungrounded	3P.3L	3PH 3Wire Ungrounded Delta		480 V L-L	600 V L-L	2 VT
3-phase 3-wire Delta corner grounded		3PH 3Wire Corner Grounded Delta		240 V L-L	600 V L-L	2 VT

Power system description	Meter setting		Symbol	Direct connect maximum (UL / IEC)		# of VTs (if required)
	Display (meter)	Display (communication)		Installation category III	Installation category II	
3-phase 3-wire Wye ungrounded		3PH 3Wire Ungrounded Wye		480 V L-L	600 V L-L	2 VT
3-phase 3-wire Wye grounded		3PH 3Wire Grounded Wye		480 V L-L	600 V L-L	2 VT
3-phase 3-wire Wye resistance-grounded		3PH 3Wire Resistance Grounded Wye		277 V L-N / 480 V L-L	347 V L-N / 600 V L-L	2 VT
3-phase 4-wire open Delta center-tapped	3P.4L	3PH 4Wire Center-Tapped Open Delta		173 V L-N / 347 V L-L	347 V L-N / 600 V L-L	3 VT
3-phase 4-wire Delta center-tapped		3PH 4Wire Center-Tapped Delta		173 V L-N / 347 V L-L	347 V L-N / 600 V L-L	3 VT
3-phase 4-wire ungrounded Wye		3PH 4Wire Ungrounded Wye		≤ 277 V L-N / 480 V L-L	≤ 347 V L-N / 600 V L-L	3 VT or 2 VT
3-phase 4-wire grounded Wye		3PH 4Wire Grounded Wye		≤ 277 V L-N / 480 V L-L	≤ 347 V L-N / 600 V L-L	3 VT or 2 VT
3-phase 4-wire resistance-grounded Wye		3PH 4Wire Resistance Grounded Wye		≤ 277 V L-N / 480 V L-L	≤ 347 V L-N / 600 V L-L	3 VT or 2 VT

Balanced system considerations

In situations where you are monitoring a balanced 3-phase load, you may choose to connect only one or two CTs on the phase(s) you want to measure, and then configure the meter so it calculates the current on the unconnected current input(s).

NOTE: For a balanced 4-wire Wye system, the meter's calculations assume that there is no current flowing through the neutral conductor.

Balanced 3-phase Wye system with 2 CTs

The current for the unconnected current input is calculated so that the vector sum for all three phases equal zero.

Balanced 3-phase Wye or Delta system with 1CT

The currents for the unconnected current inputs are calculated so that their magnitude and phase angle are identical and equally distributed, and the vector sum for all three phase currents equal zero.

NOTE: You must always use 3 CTs for 3-phase 4-wire center-tapped Delta or center-tapped open Delta systems.

Serial communications

The meter supports serial communications through the RS-485 port. Up to 32 devices can be connected on a single RS-485 bus.

In an RS-485 network, there is one master device, typically an Ethernet to RS-485 gateway. It provides the means for RS-485 communications with multiple slave devices (for example, meters). For applications that require only one dedicated computer to communicate with the slave devices, an RS-232 to RS-485 converter can be used as the master device.

RS-485 wiring

Connect the devices on the RS-485 bus in a point-to-point configuration, with the (+) and (-) terminals from one device connected to the corresponding (+) and (-) terminals on the next device.

RS-485 cable

Use a shielded 2 twisted pair or 1.5 twisted pair RS-485 cable to wire the devices. Use one twisted pair to connect the (+) and (-) terminals, and use the other insulated wire to connect the C terminals

The total distance for devices connected on an RS-485 bus should not exceed 1000 m (3280 ft).

RS-485 terminals

C	Common. This provides the voltage reference (zero volts) for the data plus and data minus signals
⊖	Shield. Connect the bare wire to this terminal to help suppress signal noise that may be present. Ground the shield wiring at one end only (either at the master or the last slave device, but not both).
-	Data minus. This transmits/receives the inverting data signals.
+	Data plus. This transmits/receives the non-inverting data signals.

NOTE: If some devices in your RS-485 network do not have the C terminal, use the bare wire in the RS-485 cable to connect the C terminal from the meter to the shield terminal on the devices that do not have the C terminal.

Pulse output

NOTE: Applicable only for PM2110 meter model

The meter is equipped with one pulse output port (D1+, D1-).

You can configure the pulse outputs for use in the following application:

- energy pulsing applications, where a receiving device determines energy usage by counting the k_h pulses coming from the meter's pulse output port.

One pulse output can handle voltage less than or equal to 40 V DC (20 mA maximum). For higher voltage applications, use an external relay in the switching circuit.

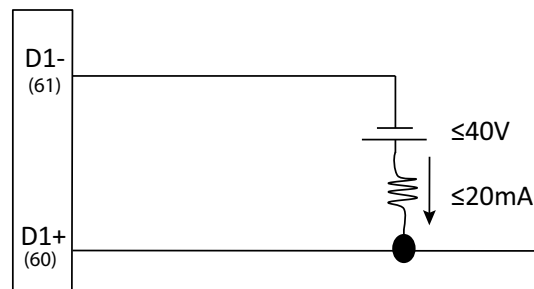

Display and meter setup

Display overview

The display lets you use the meter to perform various tasks such as setting up the meter, displaying data screens, or performing resets.

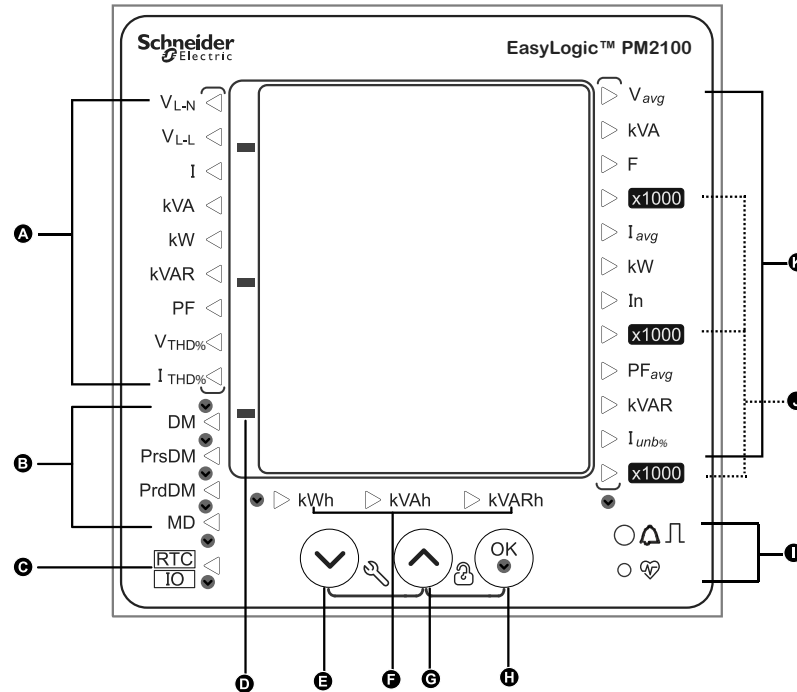

A	Phase measurements	V _{L-N} , V _{L-L} , I, kVA, kW, kVAR, PF, V _{THD} , I _{THD}
B	Demand measurements	DM, PrsDM, PrdDM, MD
C	RTC (Amber) / IO (Green)	
D	Negative indicator	
E	Navigation key	To navigate down
F	Energy readings	Apparent energy, Active energy, and Reactive energy
G	Navigation key	To navigate up
H	OK	Enter key
I	Energy pulsing LED (Red) Heartbeat / communications LED (Green)	
J	x 1000 indicator	
K	System measurements	V _{avg} , kVA, F, I _{avg} , kW, In, PF _{avg} , kVAR, I _{unb}

LED Indicators

The LED indicators alert or inform you of meter activity.

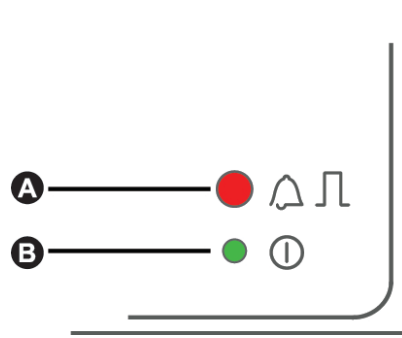

A	Alarms / Energy pulsing LED (Red)
B	Heartbeat / serial communications LED (Green)

Alarm / energy pulsing LED

The alarm / energy pulsing LED can be configured for alarm notification or energy pulsing.

When configured for alarm notification, this LED blinks every one second indicating that a high, medium or low priority alarm is tripped. The LED provides a visual indication of an active alarm condition or an inactive but unacknowledged high priority alarm.

When configured for energy pulsing, this LED flashes at a rate proportional to the amount of energy consumed. This is typically used to verify the power meter's accuracy.

Heartbeat / serial communications LED

The heartbeat / serial communications LED blinks to indicate the meter's operation and serial Modbus communications status.



The LED blinks at a slow, steady rate to indicate the meter is operational. The LED flashes at a variable, faster rate when the meter is communicating over a Modbus serial communications port.









You cannot configure this LED for other purposes.

NOTE: A heartbeat LED that remains lit and does not blink (or flash) can indicate a problem. In this case, power down the meter and reapply power. If the LED still does not blink or flash, contact Technical Support.

Button functions

The meter supports single press and combination press functions of the buttons.

Symbol	Description
	To navigate down the list of items.
 Press and hold for 2 seconds.	To move cursor to the left.
	To navigate up the list of items.

Symbol	Description
 Press and hold for 2 seconds.	To move cursor to the right.
	To select a parameter.
 Press and hold for 2 seconds.	To enter into or exit Clear page.
 + 	To enter into or exit Setup page.
 + 	To enter into or exit Diagnostics page.
 + 	To lock or unlock a meter page.

Meter screen menus

All meter screens are grouped logically, according to their function. You can access any available meter screen by first selecting the Level 1 (top level) screen that contains it.

With the meter front panel, you can view parameter values; configure parameters; perform demand resets; perform LED checks; and view meter information. Each of these functions can be accomplished by pressing the Up, Down, and OK buttons on the front panel.

These button actions achieve different results according to the mode that the meter is in:

- Display mode (default): view parameter measurements
- Setup mode: configure a parameter
- Clear mode: reset measurements
- Lock mode: lock or unlock a screen

This section describes front panel navigation within each mode.

Display screen menus

In Display mode, you can view values from the following measurement groups:

- System measurements
- Phase measurements
- Energy measurements
- Demand measurements
- RTC

Viewing display parameters

The meter’s display screen and buttons allow you to view the required parameters.

1. Press the OK button to navigate to different measurement types.
2. Press the Up or Down button to navigate to the previous or next value under each measurement type.

Display screen menu tree

Use the menu tree to navigate to the setting you want to view.

The below image summarizes the available meter screens and parameters:

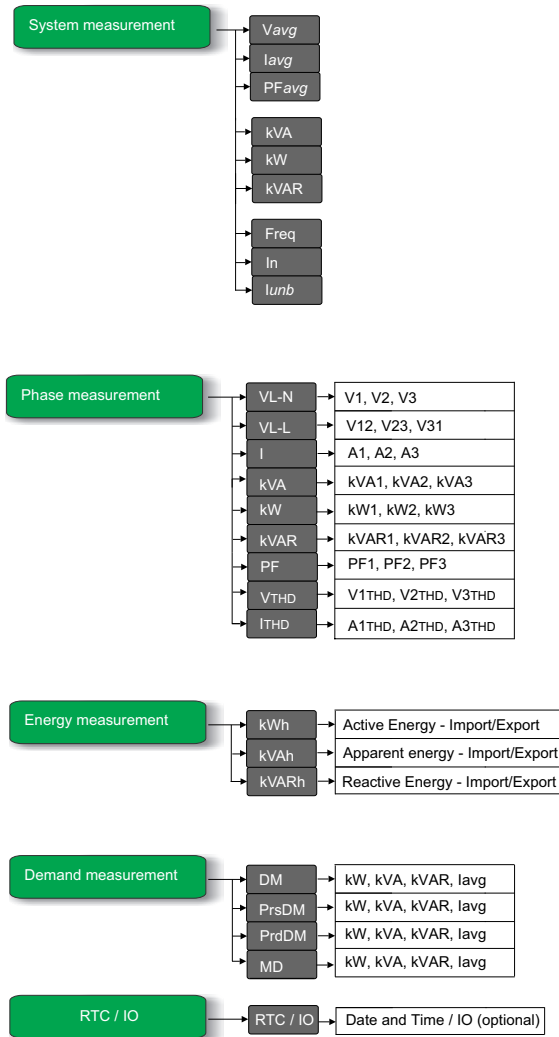

Display parameters

The meter displays various power system measurements.



Measurement Group	Parameters Measured
System measurements	V _{avg} , kVA, F, I _{avg} , kW, In, PF _{avg} , kVAR, I _{unb}
Phase measurements	V _{L-N} , V _{L-L} , I, kVA, kW, kVAR, PF, V _{THD} , I _{THD}
Demand measurements	DM, PrsDM, PrdDM, MD

Measurement Group	Parameters Measured
RTC / IO	Date and time NOTE: RTC is only applicable for meters with RS-485 communication. Meters with POP do not support this function. The meter supports digital and analog IO. NOTE: IO is supported only by PM2130 meter model. Other LED variants do not support IO function.
Energy readings	kWh (Active energy): Delivered / Received kVAh (Apparent energy): Delivered / Received kVARh (Reactive energy): Delivered / Received

NOTE: When the x 1000 LED is lit, multiply the displayed value by 1000 for the actual value.

Button functions in viewing display parameters

Display mode is the default page when you power up the meter.

Mode	Button	Function
Display Mode		To view the next parameter value.
		To view the previous parameter value.
		To move from one measurement group to the next measurement group.

Setup screen menus

Setup screen enables you to configure various setup parameters.

Below is the list of setup parameters and the configurations it supports.

Meter setup menus

Setup parameters	Parameter	Options
	tYPE	1P.LN, 1P.LL, 1P.3L, 3P.3L, 3P.4L
	Vt	no.Vt , 2.VT, 3.VT, 1.VT
	Vt.Pr	0100 V to 999000 V
	Vt.SE	100, 110, 115, 120
	Ct	A.1, A.2, A.3, A.12, A.23, A.31, A.123
	Ct.Pr	1 A to 32760 A
	Ct.SE	1 A, 5 A
	FrEq	50 Hz , 60 Hz
	Ph.Sq	123 , 321
	A.SuP	5 mA
	Pd	Ther, t.Sb, t.b , t.rb, CS.b, CS.rb, CL.b, Cl.rb
	Pd.CY	1 to 60 mins
	Pd.ut	1 to 60 mins
	Pd.SY	00:00 - 23:59
	Ad	Ther, t.Sb, t.b , t.rb, CS.b, CS.rb, CL.b, Cl.rb
	Ad.CY	1 to 60 mins
	Ad.ut	1 to 60 mins
	Ad.SY	00:00 - 23:59
	LEd	Off, EnrG, ALM
	L.PLS	1 to 9999000(Pulse per k_h)
	L.PAr	d.Wh , r.Wh, t.Wh, d.Vrh, r.Vrh, t.Vrh, d.VAh, r.VAh, t.VAh, nonE
	PASS	0000 - 9999
	CoM	ON , OFF
	Id	1 to 247
	bAud	4800, 9600, 19200 , 38400
	Prty	Even , Odd, None
	YEAr	YYYY (2000 to 2127)
	dAtE	M(month) - 1 to 12, dd(day) - 1 to 31
	hour	HH(hours) - 00 to 23, M(minitues) - 00 to 59
	PoP	Off, EnrG
	P.PLS	1 to 9999000 (k_h)
	P.PAr	Wh , Vrh, VAh













Entering setup







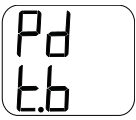

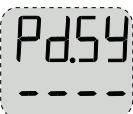

The meter's display screen and buttons allow you to navigate to and edit the required parameters.



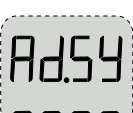





1. Press and hold the Up key and Down key simultaneously for 2 seconds.
2. Enter the password. Default password is **0000**.
3. Press OK key to enter setup.
4. Press and hold the Up key and Down key simultaneously for 2 seconds to exit Setup after viewing parameters.

Setup parameters

The meter supports configuration of various measurement parameters.

Name on display	Description	Input range	Default value
	tYPE= Power System Configurations	Input range = 1P.Ln, 1P.LL, 1P.3L, 3P.3L, 3P.4L NOTE: Other power system configurations can be set through ION setup.	3P.4L
	Vt= VT Connect	Input range = no.Vt, 2.VT, 3.VT, 1.VT NOTE: The VT Connect parameters are enabled based on selected power system configuration.	no.Vt
	Vt.Pr = Primary Voltage (V L-L)	0100 V to 999000 V NOTE: Vt.Pr will not be enabled if VT Connect is no.VT.	120
	Vt.SE = Secondary Voltage (V L-L)	100, 110, 115, 120 V NOTE: Vt.SE will not be enabled if VT Connect is no.VT.	120
	Ct = CT Terminal	A.1, A.2, A.3, A.12, A.23, A.31, A.123 NOTE: The Ct terminal parameters are enabled based on the selected power system and VT connect configuration.	A.123
	Ct.Pr = CT Primary	1 A to 32760 A NOTE: Ct primary can be set up to 32767 A through communication.	5
	Ct.SE = CT Secondary	1 A, 5 A	5
	FrEq = System Frequency	50 Hz, 60 Hz	50
	Ph.Sq = Phase sequence	123, 321	123
	A.SuP: A.Suppression (Minimum current at which meter starts functioning)	5 mA to 99 mA	5
	Pd = Power Demand	tHEr, t.Sb, t.b, t.rb, CS.b, CS.rb, CL.b, CL.rb	t.b
	Pd.CY = Power Demand Period	1 to 60 mins NOTE: The demand update time is available for rolling block methods under power demand.	15



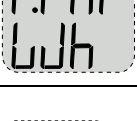
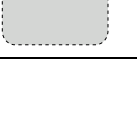

Name on display	Description	Input range	Default value
	Pd.ut = Power Demand Update Time	1 to 60 mins NOTE: The power demand update time is available for rolling block methods under power demand.	15
	Pd.SY = Power Demand Clock Sync Time	00:00 to 23:59 NOTE: The clock sync time is available only for clock sync block and clock sync roll block methods under power demand.	00.00
	Ad = Current Demand	tHEr, t.Sb, t.b, t.rb, CS.b, CS.rb, CL.b, CL.rb	t.b
	Ad.CY = Current Demand Period	1 to 60 mins	15
	Ad.ut = Current Demand Update Time	1 to 60 mins NOTE: The current demand update time is available for rolling block methods under current demand.	15
	Ad.SY = Current Demand Clock Sync Time	00:00 to 23:59 NOTE: The clock sync time is available only for clock sync block and clock sync roll block methods under current demand.	00.00
	LEd = LED	Off, EnrG, ALM	ALM
	L.PLS = LED Pulse Weight	1 to 9999000 (Pulse per k_h) NOTE: Pulse per energy values cannot be viewed if LED is off.	1
	L.PAr = LED Energy Parameter	d.Wh, r.Wh, t.Wh, d.Vrh, r.Vrh, t.Vrh, d.VAh, r.VAh, t.VAh, nonE NOTE: LED parameter values cannot be viewed if LED is off.	nonE
	PASS = Password	0000 - 9999	0000
	CoM = Communication NOTE: Id, baud rate, and parity cannot be viewed if com is off.	ON, OFF, RTFT NOTE: ON / OFF: To enable / disable communications port. NOTE: Retrofit (RTFT): For configuring legacy communication data models.	ON

Name on display	Description	Input range	Default value
	Id = Unit Id	1 to 247	1
	bAud = Baud Rate	4800, 9600, 19200, 38400	19200
	Prty = Parity	EVEn, odd, nonE	EVEn
	YEA r = RTC	YYYY (2000 to 2127)	NA
	dAtE = Month:Date	MM (month) - 1 to 12 dd (day) - 1 to 31	NA
	hour = Hours:Minutes	HH (hours) - 00 to 23 MM (minutes) - 00 to 59	NA
	PoP = Communication Pulse Output	Off, EnrG NOTE: Pulse weight and energy parameter cannot be viewed if POP is off.	EnrG
	P.PLS = POP Pulse Weight	1 to 9999000 (pulse per k_h)	200
	P.PAr = POP Energy Parameter	Wh, VAh, Vrh	Wh
	Indicates optional setup parameters		

Button functions in viewing setup parameters







The meter supports single press and combination press functions of the buttons to view setup parameters.

Mode	Button	Function
Setup Menu		To navigate to the next parameter configuration screen.

Mode	Button	Function
		To navigate to the previous parameter configuration screen.
		Enter setup mode to configure the displayed parameter value.
	 + 	Press and hold the Up and Down buttons simultaneously for 2 seconds to enter Setup. Exit setup with the same button sequence.

Button functions in editing setup parameters

The meter supports single press and combination press functions of the buttons to edit setup parameters.

Mode	Button	Function
Setup Menu		Flashing Digit: To decrease the numeric value. Flashing Value: To view the next value from the list. Flashing Decimal Point: To move the decimal point to the left.
		Flashing Digit: To increase the numeric value. Flashing Value: To view the previous value from the list. Flashing Decimal Point: To move the decimal point to the right.
	 Press and hold for 2 seconds.	Flashing Digit / Flashing Decimal Point: To move the position of the cursor to left.
	 Press and hold for 2 seconds.	Flashing Digit / Flashing Decimal Point: To move the position of the cursor to right.
		To select a parameter to edit the values. To select configured parameter values. To save the changes made to setup parameter.
	 + 	Press and hold the Up and Down buttons simultaneously for 2 seconds to enter Setup. Exit setup with the same button sequence.

Editing setup parameters

You can edit various measurement parameters as required.

1. Press and hold the Up and Down buttons simultaneously for 2 seconds to enter Setup.
2. Enter password. Default password is **0000**.
3. Press OK.

4. Press the Up or Down button to select a parameter to edit.
The selected parameter flashes the digit, value, or decimal point that is required to be set (the meter automatically determines which option to flash for editing, depending on the parameter).
5. Increase or decrease the digit value, move the decimal point, or select a value from a pre-programmed list using the Up or Down button.
6. Press OK after making the required changes.
7. Press and hold the Up and Down buttons simultaneously for 2 seconds to exit Setup.
8. Select Yes to save your settings.

Exiting setup parameters

The following steps describe how to exit setup mode without editing any parameter values.

1. Press and hold the Up and Down buttons simultaneously for 2 seconds to enter Setup.
2. Enter password. Default password is **0000**.
3. Press OK.
4. Press the Up or Down button to view various setup parameters.
5. Press and hold the Up and Down buttons simultaneously for 2 seconds to exit Setup without making any changes to the parameter values.

Demand

Demand parameters

Demand is a measure of average consumption (typically power or current) over a fixed programmed time interval.

Power / current demand setup parameters

Parameter	Values	Description
Method	<ul style="list-style-type: none"> • Thermal: Ther • Timed Sliding Block: t.Sb • Timed Block: t.b • Timed Rolling Block: t.rb • Command Sync Block: CS.b • Command Sync Rolling Block: CS.rb • Clock Sync Block: CL.b • Clock Sync Rolling Block: Cl.rb <p>NOTE: Command sync and clock sync methods are applicable for meters with RS-485 communication only.</p>	Select the appropriate demand calculation method for your needs.
Interval	1 – 60	Set the demand interval, in minutes.

Power / current demand setup parameters (Continued)

Parameter	Values	Description
Subinterval (update time)	1 – 60	Applies only to rolling block methods. Define how many subintervals the demand interval should be equally divided into.
Clock Sync Time	00:00 – 23:59	Applies only to clock sync methods (these synchronize the demand interval to the meter's internal clock). Define what time of day you want to synchronize the demand.

Viewing demand values on Display screen

You can view the demand values provided on the display screen by navigation through display parameters.

1. Press OK to navigate to demand values on display screen.
2. The LED indicates last demand (DM). The values displayed on the screen indicate kVA, kW, and kVAR.
3. Press the Down button to view I_{avg} values.
4. Repeat the steps to view present demand (PrsDM), predictive demand (PrdDM), and max demand (MD) values.

Viewing demand values in Setup screen

The meter supports editing power and current demand through setup mode.

1. Press and hold the Up and Down buttons simultaneously for 2 seconds to enter Setup.
2. Enter password. Default password is **0000**.
3. Press OK.
4. Press the Down button to select Pd (power demand) or Ad (current demand) parameter.
5. Press OK.
6. Press the Down button to select required values from the existing list.
7. Press OK.
8. Press and hold the Up and Down buttons simultaneously for 2 seconds to exit Setup.
9. Select Yes to save your settings.

Communications setup

After wiring the meter's serial communications ports, you can configure these ports so you can connect to the meter remotely and use device configuration software such as ION Setup to configure the meter.

The setup screen allows you to configure the meter's RS-485 communications port so you can use software to access the meter's data or configure the meter remotely.

To turn on communication in setup screen, follow these steps:

1. Press and hold the Up and Down buttons simultaneously for 2 seconds to enter setup.
2. Enter password. Default password is **0000**.
3. Press OK.
4. Press the Down button to select a CoM (communication) parameter.
5. Press OK.
6. Press the Down button to select **on** from the list.
7. Press OK.
8. Press and hold the Up and Down buttons simultaneously for 2 seconds to exit Setup.
9. Select Yes to save your settings.

RS-485 communication parameters

Parameter	Values	Description
Address	1 to 247	Set the address for this device. The address must be unique for each device in a communications loop.
Baud Rate	4800, 9600, 19200, 38400	Select the speed for data transmission. The baud rate must be the same for all devices in a communications loop.
Parity — Number of stop bits	Even — 1 Odd — 1 None — 2	Select None if the parity bit is not used. The parity setting must be the same for all devices in a communications loop.

NOTE: Communication parameters display ON / OFF / Retrofit (RTFT).

NOTE: Retrofit provides you an option of configuring legacy data models for your device to communicate with newer models (Applicable only for PM2120 and PM2130 meter models only).

Setting up the password

The meter password can only be configured through the front panel.

The factory-default setting for all passwords is “0000” (zero). Changing the default password for screens that are password protected prevents unauthorized personnel from accessing certain screens such as the Setup and Clear screens.

To change the meter password using Setup, follow these steps:

1. Press and hold the Up and Down buttons simultaneously for 2 seconds to enter Setup.
2. Enter password. Default password is **0000**.
3. Press OK.
4. Press the Down button to select PASS (password) parameter.
5. Press OK.
6. Press the Down button to change the digits.
 - NOTE:** Hold Down button for 2 seconds to move the cursor to the next digit.
7. Press OK.
8. Press and hold the Up and Down buttons simultaneously for 2 seconds to exit Setup.
9. Select Yes to save your settings.

Password settings

Parameter	Values	Description
Pass	0000 - 9999	Sets the password for accessing the meter setup screen. NOTE: Common password applies across all parameters.

Lost password

Visit www.se.com for support and assistance with lost passwords or other technical problems with the meter. Make sure you include your meter’s model, serial number and firmware version in your email or have it readily available if calling Technical Support.

Setting up date and time

The Clock setup allows you to set the meter’s date and time.

1. Press and hold the Up and Down buttons simultaneously for 2 seconds to enter Setup.
2. Enter password. Default password is **0000**.
3. Press OK.
4. Press the Down button to select year, date, and hour parameter.
5. Press OK.
6. Press Down button to change the digits.

NOTE: Hold the Down button for 2 seconds to move the cursor to the next digit.

7. Press OK.
8. Press and hold the Up and Down buttons simultaneously for 2 seconds to exit Setup.
9. Select Yes to save your settings.

NOTE: You must always set or sync the meter time to local time.

Clock setup parameters

Parameter	Values	Description
Year	YYYY	Set the current year using format displayed on screen.
Date	MM:DD	Set the current date using the format displayed on screen, where date is in MM (month) and DD (date) format.
Hour	HH:MM	Use the 24 hours format to set the current time in local time, where the time is in HH (hour) and MM (minutes) format.

Diagnostics (Diag) screen menus

In Diag, you can verify the front panel LEDs, and view meter information.

Below is the list of Diag parameter that are displayed on the meter screen.

Meter Diag menus

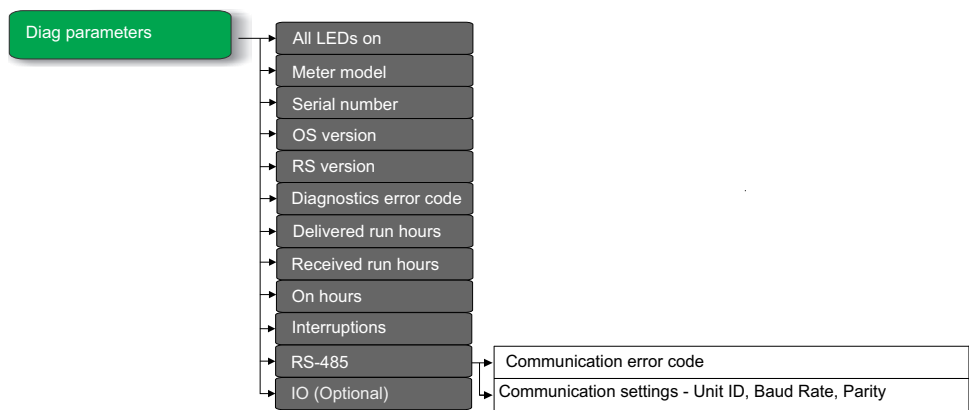

Viewing Diag

The meter’s display screen and buttons allow you to navigate to the Diag.

1. Press and hold the Down and OK buttons simultaneously for 2 seconds to view Diag.
2. Press the Down button to navigate to the next screen.
3. Press and hold the Down and OK buttons simultaneously for 2 seconds to exit Diag.





Diag screens

The meter displays various diagnostics screens.

Screens	Description	
All LEDs on	On entering diag screen, all LEDs on the front panel light up. The display shows four eights (8888), four decimal points (....) per line, negative indicators, and parameter LEDs. This indicates that the front panel LEDs and display are operating correctly.	
Meter Model	Displays the meter model number.	
Serial number	Displays the meter serial number, for example SN.0500005174. NOTE: Ensure you have your meter’s serial number information available while contacting Technical Support for help.	
OS version	Displays the operating system version number, for example OS 1.00.0.	
RS version	Displays the reset (boot code) version number, for example RS 1.00.0.	
Diagnostics error code	Displays the error codes of the meter for diagnostics. For example: 0041 is the error code for Over-Running energy pulse output.	
Run hours	Delivered / Import	Indicates the period the load has been delivered. This counter accumulates as long as the load is ON.
	Received / Export	Indicates the period the load has been received. This counter accumulates as long as the load is ON.
On hours	Indicates the period for which the power meter's auxiliary supply is ON, regardless of the voltage and current inputs.	
Interruptions	Number of supply outages, means the number of auxiliary supply interruptions. If the power meter auxiliary supply is from a UPS then the INTR (number of interruptions) will be zero (as long as the UPS stays ON), even if the voltage signals die out from time to time.	
RS-485	Communication error code	Displays the communication errors of the meter.
	Communication settings screen	Displays the unit ID, baud rate, and parity values of the meter.
IO	Displays the type of IO card used. NOTE: Only PM2130 supports external IO cards. Other variants of PM2100 series meter do not support IO card.	

Button functions in viewing Diag screen

The meter supports single press and combination press functions of the buttons to view Diag screens.

Mode	Button	Function
Setup Menu		To navigate to the next screen.
		To navigate to the previous screen.
	 + 	Press and hold the Down and OK buttons simultaneously for 2 seconds to view Diag. Exit Diag screen with the same button sequence.

Clear screen menus

Clear screen enables you to reset energy, demand, min / max, or max demand values.

Below is the list of clear screen parameter that are displayed on the meter screen.

Meter clear screen menus

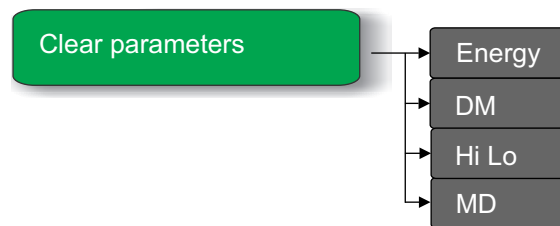

Entering Clear screen

The meter's display screen and buttons allow you to navigate to Clear.

1. Press and hold the OK button for 2 seconds.
2. Press the Up button to select Yes.
3. Press OK.
4. Enter password. Default password is **0000**.
5. Press OK.
6. Press the Down or Up button to navigate to the required parameter for clearing the values.
7. Press and hold the OK button simultaneously for 2 seconds to exit Clear screen.



Clear parameters

The meter supports reset of various parameters.

Parameters	Description
Energy	Resets the energy values. The meter supports reset of the following parameter values: <ul style="list-style-type: none"> • Active energy - Import / Export • Reactive energy - Import / Export • Apparent energy - Import / Export • Run Hour
DM	Used for demand synchronization function. The meter supports reset of the following parameter values: <ul style="list-style-type: none"> • Last demand • Present demand • Predictive demand
Hi Lo	Resets the minimum and maximum (min/max) values. The meter supports reset of the following parameter values: <ul style="list-style-type: none"> • V L-L average • V L-N average • Current average • Frequency • Active power, Total • Apparent power, Total • Reactive power, Total • Power factor, Total
MD	Resets the maximum demand values. <ul style="list-style-type: none"> • W, VA, VAR, and current demand with timestamp

Button functions in editing Clear parameters

The meter supports single press functions of the buttons to enter Clear screens.

Mode	Button	Function
Clear Screen		Press and hold OK button for 2 seconds to enter Clear. Press OK button to clear/reset parameter values. Press and hold OK button for 2 seconds to exit Clear.
		To navigate to the next parameter.
		To navigate to the previous parameter.

Lock / Unlock

Lock enables you to set the a meter screen to default screen. You can scroll to other display screens while a screen has been locked. Once the manual scrolling is stopped, the meter displays the default (lock) screen after four minutes.

The meter’s display screen and buttons allow you to lock or unlock any screen.

To lock / unlock a meter screen:

- Press and hold the Up and OK buttons simultaneously for 2 seconds to lock or unlock a meter screen.



NOTE:

You can only lock the display parameters.

You cannot enter the Setup or Clear when a meter screen is locked.

Button functions in locking / unlocking meter screen

The meter supports a combination press function of the buttons to lock or unlock a screen.

Mode	Button	Function
Lock / Unlock	 + 	Press and hold the Up and OK buttons simultaneously for 2 seconds to lock or unlock a meter screen.

Remote meter setup

Overview

You can configure the meter's setup parameters through the meter's RS-485 communications port.

The meter is factory-configured with default RS-485 communications port settings. You must modify the default settings before connecting the meter to your RS-485 network. To configure the RS-485 port, you need:

- ION Setup

ION setup

Go to www.se.com and search for ION Setup to download a copy of the installation file.

If you already have an existing installation of ION Setup, it is recommended that you upgrade to the latest version in order to access new features or enhancements and properly configure features available on your device.

Refer to the online help to learn how to use ION Setup.

RS-485 port setup

The meter is factory-configured with default serial communications settings that you may need to modify before connecting the meter to the RS-485 bus.

The meter is factory-configured with the following default serial communications settings:

- Protocol = Modbus RTU
- Address = 1
- Baud rate = 19200
- Parity = Even

You can use a communications converter (USB to RS-485 or RS-232 to RS-485) device to connect to the meter.

Meter setup through RS-485

After the meter's RS-485 port is configured and connected to the RS-485 network, you can use ION Setup to configure all other meter setup parameters.

Meter configuration using ION setup

Start ION setup, create a site (or if applicable, use an existing site), then add your meter to the site.

See the "EasyLogic PM2000 Series Power Meter" topic in the ION setup online help or in the ION setup device configuration guide. To download a copy, go to www.se.com and search for ION setup device configuration guide.

Viewing meter data

Viewing meter data from the display

Voltage average, current average, and power factor average are displayed the first time a meter is powered up, after which the last viewed screen or locked (default) screen is displayed every time the meter is powered up.



Meters data screens

The meter screens are divided as per phase measurements, system measurements, demand measurements, energy measurements, and RTC / IO.

Meter data display screens

The screen menu items are listed below.

System measurements

Vavg	Voltage, 3 phase average
kVA	Apparent power total
F	Frequency (Hz)
x1000	Multiplication factor
Iavg	Current, 3 phase average
kW	Active power total
In	Neutral current
x1000	Multiplication factor
PF _{avg}	Power factor average
kVAR	Reactive power total
Iunb	Current unbalance
x1000	Multiplication factor

Phase measurements

V _{L-N}	Voltage Line to neutral		V1	V2	V3
V _{L-L}	Voltage Line to Line		V12	V23	V31
I	Current		A1	A2	A3
kVA	Apparent Power		kVA1	kVA2	kVA3
kW	Active Power		kW1	kW2	kW3
KVAR	Reactive Power		KVAR1	KVAR2	KVAR3
PF	Power factor	- : Leading PF	PF1	PF2	PF3
		+ : Lagging PF			
V _{THD}	Voltage THD %		V1 _{THD}	V2 _{THD}	V3 _{THD}
I _{THD}	Current THD %		A1 _{THD}	A2 _{THD}	A3 _{THD}

Energy measurements

kWh	Active energy - Import / Delivered (+)				
	Active energy - Export / Received (-)				
kVAh	Apparent energy - Import / Delivered (+)				
	Apparent energy - Export / Received (-)				
kVARh	Reactive energy - Import / Delivered (+)				
	Reactive energy - Export / Received (-)				

Demand measurements

DM	Last Demand	kVA	KVAR	kW	I _{avg}
PrsDM	Present/ Raising demand	kVA	KVAR	kW	I _{avg}
PrdDM	Predictive demand	kVA	KVAR	kW	I _{avg}
MD	Max demand	kVA	KVAR	kW	I _{avg}

RTC / IO

RTC	Date and time	Year / Date / Hour
IO (Applicable only for PM2130)		

Using ION Setup to view or modify configuration data

You can use ION setup to view or modify the meter setup parameters.

Using software to view meter data

There are different software systems and methods you can use to access or display the meter data. This can range from using a simple Modbus register interface to read stored values in the meter's registers, to viewing intelligent information from the meter through an energy management system.

Power Monitoring Expert

EcoStruxure™ Power Monitoring Expert is a complete supervisory software package for power management applications.

The software collects and organizes data gathered from your facility's electrical network and presents it as meaningful, actionable information via an intuitive web interface.

Power Monitoring Expert communicates with devices on the network to provide:

- Real-time monitoring through a multi-user web portal
- Trend graphing and aggregation
- Power quality analysis and compliance monitoring
- Preconfigured and custom reporting

See the EcoStruxure™ Power Monitoring Expert online help for instructions on how to add your device into its system for data collection and analysis.

Power SCADA Operation

EcoStruxure™ Power SCADA Operation is a complete real-time monitoring and control solution for large facility and critical infrastructure operations.

It communicates with your device for data acquisition and real-time control. You can use Power SCADA Operation for:

- System supervision
- Real-time and historical trending, event logging
- PC-based custom alarms

See the EcoStruxure™ Power SCADA Operation online help for instructions on how to add your device into its system for data collection and analysis.

Modbus command interface

Most of the meter's real-time and logged data, as well as basic configuration and setup of meter features, can be accessed and programmed using a Modbus command interface as published in the meter's Modbus register list.

This is an advanced procedure that should only be performed by users with advanced knowledge of Modbus, their meter, and the power system being monitored. For further information on the Modbus command interface, contact Technical Support.

See your meter's Modbus register list at www.se.com for the Modbus mapping information and basic instructions on command interface.

I/O Modules

NOTE: Applicable only for PM2130 meter model

This section supplements the optional I/O module installation sheets and provides additional information regarding physical characteristics and capabilities of the I/O module.

The I/O modules are available in the following variants:

- Single channel analog I/O module
- Two channel analog I/O module
- Two channel digital I/O module
- Two channel digital input and relay output module

Analog input applications

The analog inputs interpret an incoming analog current signal from transducers. The analog I/O module can measure current using standard 4 - 20 mA analog transducers.

For analog input operation, the meter takes an analog input signal and provides the resulting scaled value. Analog inputs may show a value below zero scale if an open circuit is detected on the input port.

You can set the analog input's mode for current sensing.

Wiring the analog input

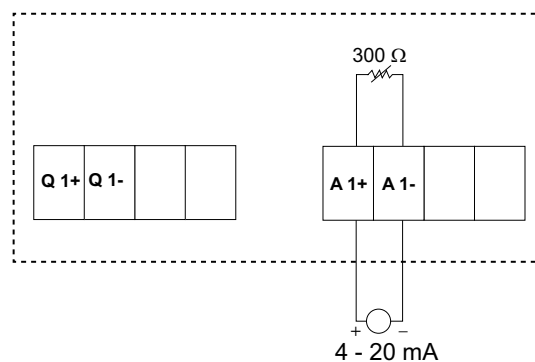

Wiring the dual analog inputs

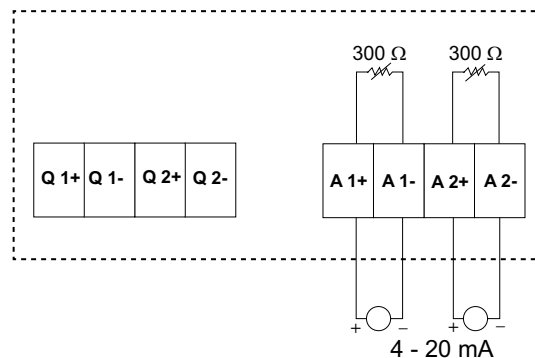

You can configure the following analog inputs on your meter through communication only:

Code	Unit	Description
0	–	No units
1	%	Percentage
2	°C	Degrees Celsius
3	°F	Degrees Fahrenheit
4	Deg	Degrees Angular
5	Hz	Hertz
6	A	Amperes
7	kA	Kilo Amperes
8	V	Volts
9	kV	Kilo Volts
10	MV	Mega Volts
11	W	Watts
12	kW	Kilowatts
13	MW	Megawatts
14	VAR	Volt-Ampere Reactive
15	kVAR	Kilo Volt-Ampere Reactive
16	MVAR	Mega Volt-Ampere Reactive
17	VA	Volt-Amperes
18	kVA	Kilo Volt-Amperes
19	MVA	Mega Volt-Amperes
20	WH	Watt-Hour
21	kWH	Kilowatt-Hour
22	MWH	Megawatt-Hour
23	VARH	Reactive Volt-Ampere Hour
24	kVARH	Reactive Kilo Volt-Ampere Hour
25	MVARH	Reactive Mega Volt-Ampere Hour
26	VAH	Volt-Ampere Hours
27	kVAH	Kilo Volt-Ampere Hours
28	MVAH	Mega Volt-Ampere Hours
29	Seconds	Seconds
30	Minutes	Minutes
31	Hours	Hours
32	Bytes (RAM)	Bytes
33	kBytes (RAM)	Kilobytes
34	\$	Dollars
35	gal	Gallons
36	gal/hr	Gallons/hour
37	gal/min	Gallons/minute
38	cfm	Cubic feet/min
39	PSI	PSI
40	BTU	BTU
41	L	Liters
42	ton-hours	Ton-hours
43	l/hr	Liters/hour

Code	Unit	Description
44	l/min	Liters/min
45	€	Euros
46	ms	Milliseconds
47	m ³	Cubic-meters
48	m ³ /sec	Cubic-meters/sec
49	m ³ /min	Cubic-meters/min
50	m ³ /hr	Cubic-meters/hour
51	Pa	Pascals
52	Bars	Bar
53	RPM	Revolutions/min
55	BTU/hr	BTU/hour
56	PSIG	Pounds/square inch gauge
57	SCFM	Standard cubic feet/min
58	MCF	Thousand cubic feet
59	Therm	Therm
60	SCFH	Standard cubic feet/hour
61	PSIA	Pounds/square inch absolute
62	lbs	Pounds
63	kg	Kilogram
64	klbs	Kilopounds
65	lb/hr	Pound/hour
66	ton/hr	Ton/hour
67	kg/hr	Kilogram/hour
68	in. Hg	Inch of Mercury
69	kPa	KiloPascals
70	%RH	Percentage of relative humidity
71	MPH	Miles per hour
72	m/sec	Meters/sec
73	mV/cal/(cm ² /min)	MilliVolts/calorie/(square centimeters/min)
74	in	Inches
75	mm	Millimeter
76	GWH	GigaWatt-Hour
77	GVARH	Reactive Giga Volt-Ampere Hour
78	GVAH	Giga Volt-Ampere Hours
79	AH	Ampere-Hours
80	kAH	Kiloamp-Hours
81	Therm/hr	Therm/hour

Analog output applications

The analog I/O module can send low current for standard 4 - 20 mA analog transducers.

For analog output operation, the meter takes an input value and scales it to the appropriate signal value to send out the physical analog output port.

Wiring the analog output

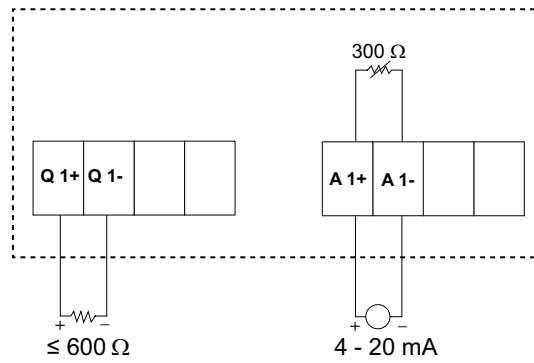

Wiring the dual analog output

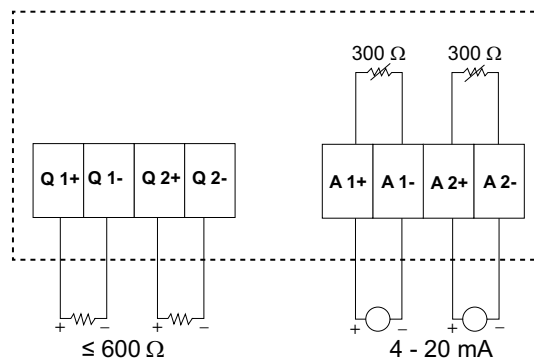

You can configure the following analog outputs on your meter through communication only:

Parameters	Description
Current	Current: Phase wise
	Current Average
	Current Unbalance: Phase wise
	Current Unbalance Worst
Voltage	Voltage L-L: Phase wise
	Voltage L-L Avg
	Voltage L-N: Phase wise
	Voltage L-N Avg
	Voltage Unbalance L-L: Phase wise
	Voltage Unbalance L-L Worst
	Voltage Unbalance L-N: Phase wise
	Voltage Unbalance L-N Worst
Power	Active Power: Phase wise
	Active Power Total
	Reactive Power: Phase wise
	Reactive Power Total
	Apparent Power: phase wise
	Apparent Power Total
PF	PF Total
Frequency	Frequency

Status input (DI) applications

Status inputs are typically used for monitoring the status of external contacts or circuit breakers.

The meter’s status inputs require either an external voltage source or whetting voltage (provided in the meter) to detect the status input’s ON/OFF state. The meter detects an ON state if the external voltage appearing at the status input is within its operating range.

Wiring the status inputs

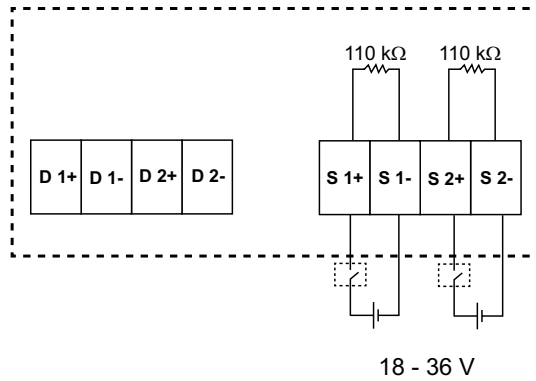

Configuring status inputs using ION Setup

The status input ports (S1 and S2) can be configured using ION Setup.

1. Start ION Setup.
2. Connect to your meter.
3. Navigate to **I/O configuration > I/O Setup**.
4. Select a status input to configure and click **Edit**.
The setup screen for that status input is displayed.
5. Enter a descriptive name for the status input’s **Label**.
6. Configure the other setup parameters as required.
7. Click **Send** to save your changes.

Status input setup parameters available through ION Setup

Parameter	Values	Description
Label	—	Use this field to change the default label and assign a descriptive name to this status input.
Control Mode	Normal, Demand Sync	This field displays how the status input functions. <ul style="list-style-type: none"> • Normal: the status input is not associated with another meter function. The meter counts and records the number of incoming pulses normally. • Demand Sync: the status input is associated with one of the input sync demand functions. The meter uses the incoming pulse to synchronize its demand period with the external source.
Debounce	0 to 9999	Debounce is the time delay that compensates for mechanical contact bounce. Use this field to set how long (in milliseconds) the external signal must remain in a certain state to be considered a valid state change.
Associations	—	This field displays additional information if the status input is already associated with another meter function.

Digital output applications

The meter is equipped with two digital output ports (D1, D2). You can configure the digital outputs for use in the following applications:

Switching applications, for example, to provide on/off control signals for switching capacitor banks, generators, and other external devices and equipment.

Energy pulsing applications, where a receiving device determines energy usage by counting the kWh pulses coming from the meter's digital output port.

Unary, digital and standard alarm configurations.

Wiring the digital output

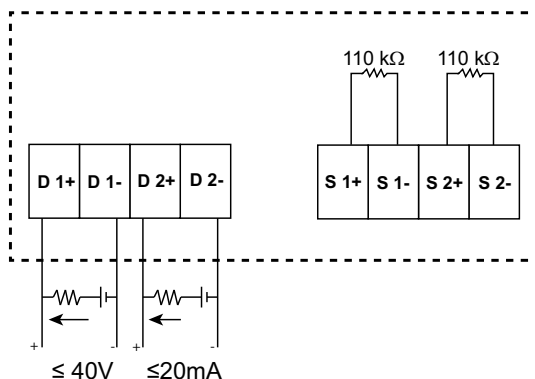

Default digital output state

The default digital output state for I/O pin is high (switch closed). The digital output state for I/O pin can be changed through communication.

I/O pin state	External mode	Alarm	Display	Comm	Switch
Low	0	0	OFF	0	Open
	0	1	ON	1	Closed
	0	0	OFF	0	Open
	1	0	ON	1	Closed
High	0	0	OFF	0	Closed
	0	1	ON	1	Open
	0	0	OFF	0	Closed
	1	0	ON	1	Open

Demand parameter for digital output

The associating demand parameters (Present demand (VA, W, VAR), Last demand (VA, W, VAR) and Predict demand (VA, W, VAR)) can be configured for digital output based on alarm events when exceeds the set upper limit. Only one demand parameter can be set at a given time.

NOTE: The alarm set up is done through communication using ION setup.

Configuring digital outputs using ION Setup

You can use ION Setup to configure the digital outputs.

1. Start ION Setup.
2. Connect to your meter.
3. Navigate to **I/O configuration > I/O Setup**.
4. Select a digital output to configure and click **Edit**.
The setup screen for that digital output is displayed.
5. Enter a descriptive name for the digital output in the **Label** field.
6. Configure the other setup parameters as required.
7. Click **Send** to save your changes.

Digital output setup parameters available using ION Setup

Parameter	Values	Description
Label	—	Use this field to change the default label and assign a descriptive name to this digital output.
Control Mode	External, Alarm, Energy	This field displays how the digital output functions. <ul style="list-style-type: none"> • External: the digital output is controlled remotely either through software or by a PLC using commands sent through communications. • Alarm: the digital output is associated with the alarm system. The meter sends a pulse to the digital output port when the alarm is triggered. • Energy: The digital output is associated with energy pulsing. When this mode is selected, you can select the energy parameter and the set the pulse rate (pulses/kW).
Behavior Mode	Normal, Timed, Coil Hold	<ul style="list-style-type: none"> • Normal: this mode applies when control mode is set to External or Alarm. In the event of trigger for External mode, the digital output remains in the ON state until an OFF command is sent by the computer or PLC. In the event of trigger for Alarm mode, the digital output remains in the ON state until the drop out point is crossed. • Timed: the digital output remains ON for the period defined by the On Time setup register. • Coil Hold: this mode applies when control mode is set to External or Alarm. For a unary alarm that is associated with a digital output, you must set Behavior Mode to Coil Hold. The output turns on when the “energize” command is received and turns off when the “coil hold release” command is received. In the event of a control power loss, the output remembers and returns to the state it was in when control power was lost.
On Time (s)	0 to 9999	This setting defines the pulse width (ON time) in seconds. NOTE: In energy mode, the digital output pulse ON time is fixed for 20 ms.
Select Alarms	All available alarms	Applies when Control Mode is set to Alarm. Select one or more alarms to monitor.
Associations	—	This field displays additional information if the digital output is already associated with another meter function.

Relay output applications

Relay outputs can be configured to be used in switching applications, for example, to provide on/off control signals for switching capacitor banks, generators, and other external devices and equipment.

Wiring the two digital inputs and relay output

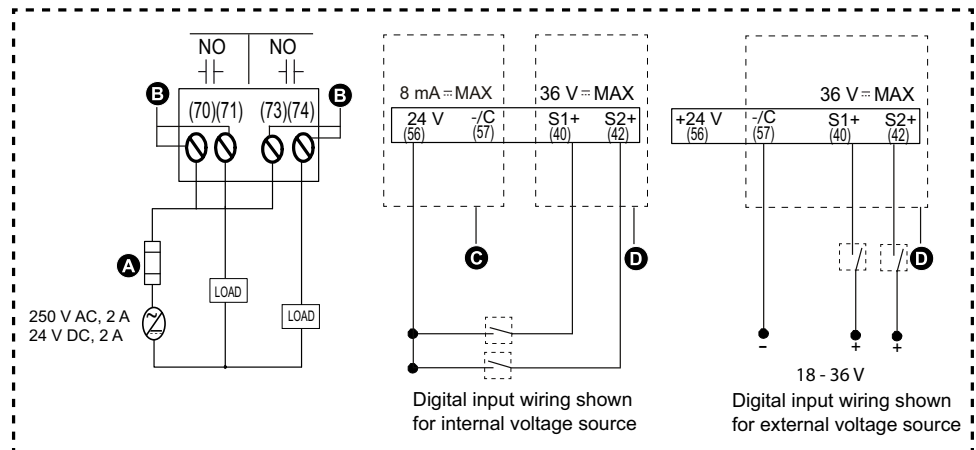

A	Overcurrent protective device
B	Relay 1 (70, 71), Relay 2 (73, 74)
C	Whetting output (56, 57)
D	Digital status inputs (40, 42, 57)

Configuring relay outputs using ION Setup

You can use ION Setup to configure the relay output ports (Relay 1 and Relay 2).

1. Start ION Setup.
2. Connect to your meter.
3. Navigate to **I/O configuration > I/O Setup**.
4. Select a relay output to configure and click **Edit**.
The setup screen for that relay output is displayed.
5. Enter a descriptive name for the relay output's **Label**.
6. Configure the other setup parameters as required.

7. Click **Send** to save your changes.

Relay output setup parameters available through the ION Setup

Parameter	Values	Description
Label	—	Use this field to change the default label and assign a descriptive name to this relay output.
Control Mode	External, Alarm	This field displays how the relay output functions. <ul style="list-style-type: none"> External: the relay output is controlled remotely either through software or by a PLC using commands sent through communications. Alarm: the relay output is associated with the alarm system. The meter sends a pulse to the relay output port when the alarm is triggered.
Behavior Mode	Normal, Timed, Coil Hold	<ul style="list-style-type: none"> Normal: this mode applies when control mode is set to External or Alarm. In the event of trigger for External mode, the relay output remains in the closed state until an open command is sent by the computer or PLC. In the event of trigger for Alarm mode, the relay output remains in the closed state until the drop out point is crossed. Timed: the relay output remains ON for the period defined by the On Time setup register. Coil Hold: this mode applies when control mode is set to External or Alarm. For a unary alarm that is associated with a relay output, you must set Behavior Mode to Coil Hold. The output turns on when the “energize” command is received and turns off when the “coil hold release” command is received. In the event of a control power loss, the output remembers and returns to the state it was in when control power was lost.
On Time (s)	0 to 9999	This setting defines the pulse width (ON time) in seconds.
Select Alarms	All available alarms	Applies when Control Mode is set to Alarm. Select one or more alarms to monitor.
Associations	—	This field displays additional information if the relay output is already associated with another meter function.

IO LED Indicator

The IO LED indicator alerts or informs you of meters’ IO activities. The LED blinks at a constant pace when the IO module is attached to the meter.

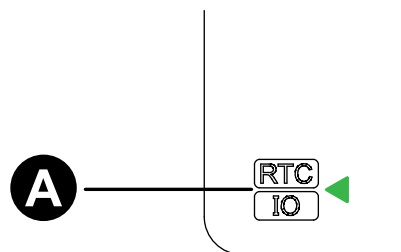

A	IO LED indicator (Green)
---	--------------------------

Alarms

Alarms overview

NOTE: Applicable only for PM2130 meter model

An alarm is the meter's means of notifying you when an alarm condition is detected, such as an error or an event that falls outside of normal operating conditions. Alarms are typically setpoint-driven and can be programmed to monitor certain behaviors, events or unwanted conditions in your electrical system.

You can configure your meter to generate and display high, medium and low priority alarms when predefined events are detected in the meter's measured values or operating states. Your meter also logs the alarm event information.

The meter ships with some alarms already enabled from the factory. Other alarms need to be configured before the meter can generate alarms.

Customize meter alarms as required, such as changing the priority. You can also create custom alarms using the advanced features of your meter.

Alarm types

Your meters supports a number of different alarm types.

Type	METSEPM2KANLGIO22	METSEPM2KANLGIO22D	METSEPM2KANLGIO11	METSEPM2KANLGIO11D
Unary	4	4	4	4
Digital	—	—	—	—
Standard	23	23	23	23

Type	METSEPM2KDGTLIO22	METSEPM2KDGTLIO22D	METSEPM2K2DI2RO	METSEPM2K2DI2ROD
Unary	4	4	4	4
Digital	2	2	2	2
Standard	23	23	23	23

Unary alarms

A unary alarm is the simplest type of alarm — it monitors a single behavior, event or condition.

Available unary alarms

Your meter has a set of 4 unary alarms.

Alarm label	Description
Meter Powerup	Meter powers on after losing control power.
Meter Reset	Meter resets for any reason.
Meter Diagnostic	Meter's self-diagnostic feature detects a problem.
Phase Reversal	Meter detects a phase rotation different than expected.

Digital alarms

Digital alarms monitor the ON or OFF state of the meter’s digital / status inputs.

Digital alarm with setpoint delay

To prevent false triggers from erratic signals, you can set up pickup and dropout time delays for the digital alarm.

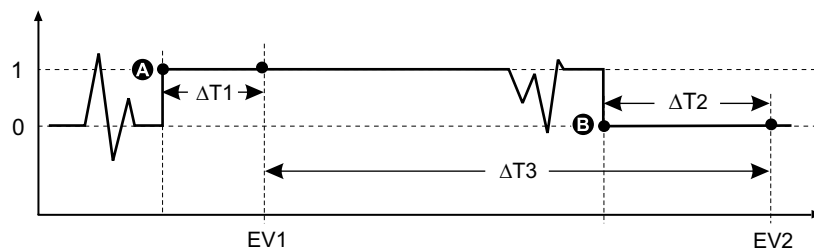

A	Pickup setpoint (1 = ON)	$\Delta T2$	Dropout time delay (in seconds)
B	Dropout setpoint (0 = OFF)	EV2	End of alarm condition
$\Delta T1$	Pickup time delay (in seconds)	$\Delta T3$	Alarm duration (in seconds)
EV1	Start of alarm condition		

NOTE: To prevent filling the alarm log with nuisance alarm trips, the digital alarm is automatically disabled if the digital / status input changes state more than 4 times in one second or more than 10 times in ten seconds. In this case, you must re-enable the alarm using the display or ION Setup.

Available digital alarms

Your meter has a set of 2 digital alarms.

Alarm label	Description
Digital Alarm S1	Digital input 1
Digital Alarm S2	Digital input 2

Standard alarms

Standard alarms are setpoint-driven alarms which monitor certain behaviors, events or unwanted conditions in your electrical system.

Standard alarms have a detection rate equal to the 50/60 meter cycle, which is nominally 1 second if the meter’s frequency setting is configured to match the system frequency (50 or 60 Hz).

Many of the standard alarms are three-phase alarms. Alarm setpoints are evaluated for each of the three phases individually, but the alarm is reported as a single alarm. The alarm pickup occurs when the first phase exceeds the alarm pickup magnitude for the pickup time delay. The alarm is active as long as any phase remains in an alarm state. The alarm dropout occurs when the last phase drops below the dropout magnitude for the dropout time delay.

Example of over and under setpoint (standard) alarm operation

The meter supports over and under setpoint conditions on standard alarms.

A setpoint condition occurs when the magnitude of the signal being monitored crosses the limit specified by the pickup setpoint setting and stays within that limit for a minimum time period specified by the pickup time delay setting.

The setpoint condition ends when the magnitude of the signal being monitored crosses the limit specified by dropout setpoint setting and stays within that limit for a minimum time period specified by dropout time delay setting.

Over setpoint

When the value rises above the pickup setpoint setting and remains there long enough to satisfy the pickup time delay period ($\Delta T1$), the alarm condition is set to ON. When the value falls below the dropout setpoint setting and remains there long enough to satisfy the dropout time delay period ($\Delta T2$), the alarm condition is set to OFF.

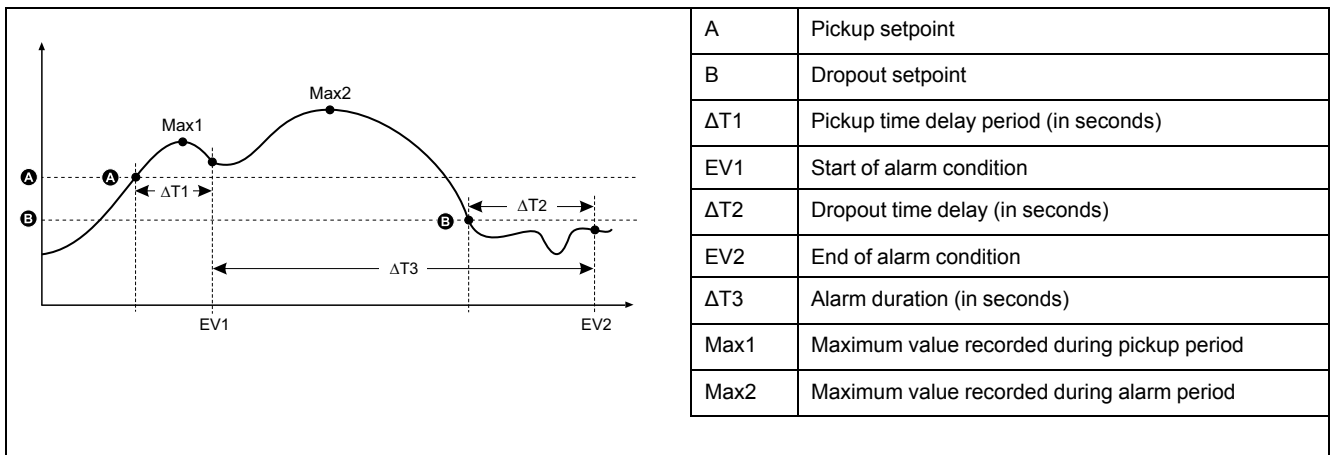

The meter records the date and time when the alarm event starts (EV1) and when it ends (EV2). The meter also performs any task assigned to the event, such as operating a digital output. The meter also records maximum values (Max1, Max2) before, during or after the alarm period.

Under setpoint

When the value falls below the pickup setpoint setting and remains there long enough to satisfy the pickup time delay period ($\Delta T1$), the alarm condition is set to ON. When the value rises above the dropout setpoint setting and remains there long enough to satisfy the dropout time delay period ($\Delta T2$), the alarm condition is set to OFF.

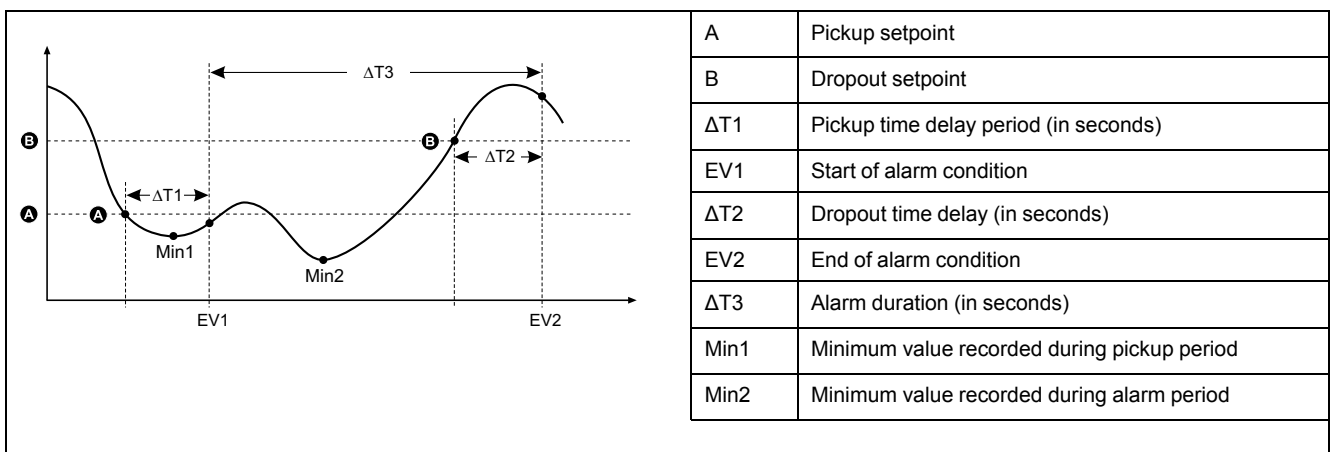

The meter records the date and time when the alarm event starts (EV1) and when it ends (EV2). The meter also performs any task assigned to the event, such as operating a digital output. The meter also records minimum values (Min1, Min2) before, during or after the alarm period.

Maximum allowable setpoint

The meter is programmed to prevent user data entry errors, with set limits for the standard alarms.

The maximum setpoint value you can enter for some of the standard alarms depends on the voltage transformer ratio (VT ratio), current transformer ratio (CT ratio), system type (i.e., number of phases) and/or the maximum voltage and maximum current limits programmed at the factory.

NOTE: VT ratio is the VT primary divided by the VT secondary and CT ratio is the CT primary divided by the CT secondary.

Standard alarm	Maximum setpoint value
Over Phase Current	(maximum current) x (CT ratio)
Under Phase Current	(maximum current) x (CT ratio)
Under Voltage L-L	(maximum voltage) x (VT ratio)
Over Voltage L-N	(maximum voltage) x (VT ratio)
Under Voltage L-N	(maximum voltage) x (VT ratio)
Over Active Power	(maximum voltage) x (maximum current) x (number of phases)
Over Reactive Power	(maximum voltage) x (maximum current) x (number of phases)
Over Apparent Power	(maximum voltage) x (maximum current) x (number of phases)
Over Present Active Power Demand	(maximum voltage) x (maximum current) x (number of phases)
Over Last Active Power Demand	(maximum voltage) x (maximum current) x (number of phases)
Over Predicted Active Power Demand	(maximum voltage) x (maximum current) x (number of phases)
Over Present Reactive Power Demand	(maximum voltage) x (maximum current) x (number of phases)
Over Last Reactive Power Demand	(maximum voltage) x (maximum current) x (number of phases)
Over Predicted Reactive Power Demand	(maximum voltage) x (maximum current) x (number of phases)
Over Present Apparent Power Demand	(maximum voltage) x (maximum current) x (number of phases)
Over Last Apparent Power Demand	(maximum voltage) x (maximum current) x (number of phases)
Over Predicted Apparent Power Demand	(maximum voltage) x (maximum current) x (number of phases)

Available standard alarms

Your meter has a set of standard alarms.

NOTE: Some alarms do not apply to all power system configurations. For example, line-to-neutral voltage alarms cannot be enabled on 3-phase delta systems. Some alarms use the system type and the VT or CT ratio to determine the maximum allowed setpoint.

Alarm label	Valid range and resolution	Units
ION Setup	ION Setup	
Over Phase Current	0.000 to 99999.000	A
Under Phase Current	0.000 to 99999.000	A
Over Voltage L-L	0.00 to 999999.00	V

Alarm label	Valid range and resolution	Units
ION Setup	ION Setup	
Under Voltage L-L	0.00 to 999999.00	V
Over Voltage L-N	0.00 to 999999.00	V
Under Voltage L-N	0.00 to 999999.00	V
Over Active Power	0.0 to 9999999.0	kW
Over Reactive Power	0.0 to 9999999.0	KVAR
Over Apparent Power	0.0 to 9999999.0	kVA
Leading True PF	-1.00 to -0.01 and 0.01 to 1.00	—
Lagging True PF	-1.00 to -0.01 and 0.01 to 1.00	—
Over Frequency	0.000 to 99.000	Hz
Under Frequency	0.000 to 99.000	Hz
Over Voltage THD	0.000 to 99	%
Over Present Active Power Demand	0.0 to 9999999.0	kW
Over Last Active Power Demand	0.0 to 9999999.0	kW
Over Predicted Active Power Demand	0.0 to 9999999.0	kW
Over Present Reactive Power Demand	0.0 to 9999999.0	KVAR
Over Last Reactive Power Demand	0.0 to 9999999.0	KVAR
Over Predicted Reactive Power Demand	0.0 to 9999999.0	KVAR
Over Present Apparent Power Demand	0.0 to 9999999.0	kVA
Over Last Apparent Power Demand	0.0 to 9999999.0	kVA
Over Predicted Apparent Power Demand	0.0 to 9999999.0	kVA

Power factor (PF) alarms

You can set up a Leading PF or Lagging PF alarm to monitor when the circuit's power factor goes above or below the threshold you specify.

The Leading PF and Lagging PF alarms use the power factor quadrants as the values on the y-axis, with quadrant II on the lowest end of the scale, followed by quadrant III, quadrant I, and finally quadrant IV on the highest end of the scale.

Quadrant	PF values	Lead/Lag
II	0 to -1	Leading (capacitive)
III	-1 to 0	Lagging (inductive)
I	0 to 1	Lagging (inductive)
IV	1 to 0	Leading (capacitive)

Leading PF alarm

The Leading PF alarm monitors an over setpoint condition.

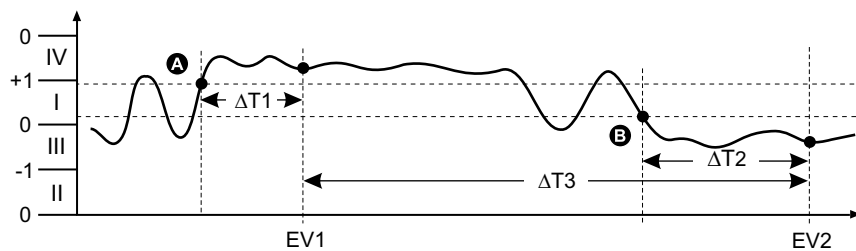

A	Pickup setpoint	$\Delta T2$	Dropout time delay (in seconds)
B	Dropout setpoint	EV2	End of alarm condition
$\Delta T1$	Pickup delay period (in seconds)	$\Delta T3$	Alarm duration (in seconds)
EV1	Start of alarm condition		

Lagging PF alarm

The Lagging PF alarm monitors an under setpoint condition.

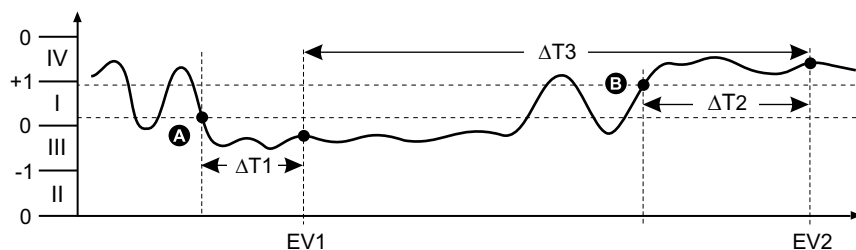

A	Pickup setpoint	$\Delta T2$	Dropout time delay (in seconds)
B	Dropout setpoint	EV2	End of alarm condition
$\Delta T1$	Pickup delay period (in seconds)	$\Delta T3$	Alarm duration (in seconds)
EV1	Start of alarm condition		

Alarm priorities

Each alarm has a priority level that you can use to distinguish between events that require immediate action and those that do not require action.

Alarm priority	Alarm display notification and recording method	
	Alarm LED	Alarm logging
High	Blinks while the alarm is active.	Recorded in alarm log.
Medium	Blinks while the alarm is active.	Recorded in alarm log.
Low	Blinks while the alarm is active.	Recorded in alarm log.
None	No activity	Recorded in event log only.

NOTE: The alarm LED notification only occurs if the alarm / energy pulsing LED is configured for alarming.

Alarm setup overview

You can use ION Setup to configure unary, digital or standard (1-Sec) alarms.

If you make changes to the basic meter setup, all alarms are disabled to prevent undesired alarm operation.

NOTICE
<p>UNINTENDED EQUIPMENT OPERATION</p> <ul style="list-style-type: none"> • Verify all alarm settings are correct and make adjustments as necessary. • Re-enable all configured alarms. <p>Failure to follow these instructions can result in incorrect alarm functions.</p>

Built-in error-checking

ION Setup dynamically checks incorrect setup combinations. When you enable an alarm, you must set up the pickup and dropout limits to acceptable values first in order to exit the setup screen.

Setting up alarms using ION Setup

You can use ION Setup to create and set up alarms.

1. Start ION Setup and connect to your meter.
2. Open the **Alarming** screen.
3. Select the alarm you want to configure and click **Edit**.
4. Configure the setup parameters as explained in the different alarm setup sections.

See the ION Setup Device Configuration guide for more information.

Unary alarm setup parameters

Configure the unary alarm setup parameters as required.

ION Setup controls are shown in parentheses.

Setting	Option or range	Description
Enable	Yes (checked) or No (cleared)	This enables or disables the alarm.
Priority	High, Medium, Low, None	This sets the alarm priority and notification options.
Select Dig Output (Outputs)	None Digital Output D1 Digital Output D2 Digital Output D1 & D2	Select the digital output(s) you want to control when the alarm is triggered.
Behaviour	Normal Timed Coil Hold	Select the required behaviour mode NOTE: When you select Normal value, Digital Output is not triggered

Digital alarm setup parameters

Configure the digital alarm setup parameters as required.

ION Setup controls are shown in parentheses.

Setting	Option or range	Description
Enable	Yes (checked) or No (cleared)	This enables or disables the alarm.
Priority	High, Medium, Low, None	This sets the alarm priority and notification options.
Pickup Setpoint (Setpoint Pickup)	On, Off	Use this setting to control when to trip the alarm, based on the state of the digital input (On or Off).
Pickup Time Delay (Delay)	0 to 999999	This specifies the number of seconds the digital input must be in the alarm pickup state before the alarm is tripped.
Dropout Time Delay (Setpoint Dropout Delay)	0 to 999999	This specifies the number of seconds the digital input must be out of the alarm pickup state before the alarm turns off.
Select Dig Output (Outputs)	None Digital Output D1 Digital Output D2 Digital Output D1 & D2	Select the digital output(s) you want to control when the alarm is triggered.

Standard (1-Sec) alarm setup parameters

Configure the standard alarm setup parameters as required.

ION Setup controls are shown in parentheses.

NOTE: It is recommended that you use ION Setup to configure standard (1-Sec) alarms. ION Setup supports a higher resolution to allow you to specify more decimal places when setting up the pickup setpoint and dropout setpoint values for certain measurements.

Setting	Option or range	Description
Enable	Yes (checked) or No (cleared)	This enables or disables the alarm.
Priority	High, Medium, Low, None	This sets the alarm priority and notification options.
Pickup Setpoint mA (Pickup Limit)	Varies depending on the standard alarm you are setting up	This is the value (magnitude) you define as the setpoint limit for triggering the alarm. For "over" conditions, this means the value has gone above the Pickup limit. For "under" conditions, this means the value has gone below the Pickup limit.
Pickup Time Delay (Delay)	0 to 999999	This specifies the number of seconds the signal must stay above the pickup setpoint (for "over" conditions), or below the pickup setpoint (for "under" conditions) before the alarm is tripped.
Dropout Setpoint mA (Dropout Limit)	Varies depending on the standard alarm you are setting up	This is the value (magnitude) you define as the limit for dropping out of the alarm condition. For "over" conditions, this means the value has gone below the Dropout limit. For "under" conditions, this means the value has gone above the Pickup limit.
Dropout Time Delay (Delay)	0 to 999999	This specifies the number of seconds the signal must stay below the dropout setpoint (for "over" conditions), or above the dropout setpoint (for "under" conditions) before the alarm condition is ended.
PU Set Point Lead/Lag (Lead, Lag)	Lead or Lag	Applies to PF (power factor) alarms only. Use this to set the PF value and quadrant to set the pickup setpoint for an over PF condition (PF Leading) or under PF condition (PF Lagging).

Setting	Option or range	Description
DO Set Point Lead/Lag (Lead, Lag)	Lead or Lag	Applies to PF (power factor) alarms only. Use this to set the PF value and quadrant to set the dropout setpoint for an over PF condition (PF Leading) or under PF condition (PF Lagging).
Select Dig Output (Outputs)	None Digital Output D1 Digital Output D2 Digital Output D1 & D2	Select the digital output(s) you want to control when the alarm is triggered.

LED alarm indicator

You can use the meter's alarm / energy pulsing LED as an alarm indicator. When set to detect alarms, the LED blinks to indicate an alarm condition.

Configuring the LED for alarms using ION Setup

You can use the ION Setup to configure your meter's LED for alarming.

1. Open ION Setup and connect to your meter. See the ION Setup Help for instructions.
2. Navigate to **Energy Pulsing**.
3. Select **Front Panel LED** and click **Edit**.
4. Set the control mode to **Alarm** and click **OK**.
5. Click **Send** to save your changes.

Alarms counters

Every occurrence of each type of alarm is counted and recorded in the meter.

Alarms rollover value

The alarm counters roll over to zero after reaching the value 9999.

Meter logging

Logs overview

This chapter briefly describes the following logs of the meter:

- Alarm log
- User-defined data log

Logs are files stored in the non-volatile memory of the meter and are referred to as “on-board logs”.

Setting up the data log

You can select 2 items to record in the data log and the frequency (logging interval) that you want those values updated.

Use ION Setup to configure data logging.

NOTICE
<p>DATA LOSS</p> <p>Save the contents of the data log before configuring it.</p> <p>Failure to follow these instructions can result in data loss.</p>

1. Start ION Setup and open your meter in setup screens mode (**View > Setup Screens**). See the ION Setup Help for instructions.
2. Double-click **Data Log #1**.
3. Set up the logging frequency and measurements/data to log.
4. Click **Send** to save the changes to the meter.

Parameter	Values	Description
Status	Enable, Disable	Set this parameter to enable or disable data logging in the meter.
Interval	15 minutes, 30 minutes, 60 minutes	Select a time value to set the logging frequency.
Channels	Items available for logging can vary based on the meter type.	Select an item to record from the “Available” column, then click the double-right arrow button to move the item to the “Selected” column. To remove an item, select it from the “Selected” column then click the double-left arrow button.

Saving the data log contents using ION Setup

You can use ION Setup to save the contents of the data log.

1. Start ION Setup and open your meter in data screens mode (**View > Data Screens**). See the ION Setup help for instructions.
2. Double-click **Data Log #1** to retrieve the records.

3. Once the records have finished uploading, right-click anywhere in the viewer and select **Export CSV** from the popup menu to export the entire log.
NOTE: To export only selected records in the log, click the first record you want to export, hold down the SHIFT key and click the last record you want to export, then select **Export CSV** from the popup menu.
4. Navigate to the folder where you want to save the data log file, then click **Save**.

Alarm log

Alarm records are stored in the meter's alarm history log.

By default, the meter can log the occurrence of any alarm condition. Each time an alarm occurs it is entered into the alarm log. The alarm log in the meter stores the pickup and dropout points of alarms along with the date and time associated with these alarms. You can view and save the alarm log to disk, and reset the alarm log to clear the data out of the meter's memory.

The meter stores alarm log data in non-volatile memory. The size of the alarm log is fixed at 40 records.

Meter resets

Meter resets

Resets allow you to clear various accumulated parameters stored on your meter or reinitialize the meter or meter accessories.

Meter resets clear your meter's onboard data logs and other related information. Resets are typically performed after you make changes to the meter's basic setup parameters (such as frequency, VT/PT or CT settings) to clear invalid or obsolete data in preparation for putting the meter into active service.

Meter initialization

Meter Initialization is a special command that clears the meter's energy, power, demand values, and meter operation timer.

It is common practice to initialize the meter after its configuration is completed, before adding it to an energy management system.

After configuring all the meter setup parameters, navigate through the different meter display screens and make sure the displayed data is valid then perform meter initialization.

NOTE: You can perform meter initialization using ION setup and secured command interface.

Performing resets using ION Setup

Resets allow you to clear all data of a particular type, such as all energy values or all minimum/maximum values.

1. Start ION Setup.
2. Connect to your meter.
3. Navigate to **Meter Resets**.

4. Select a parameter for reset and click **Reset**.

The selected parameter value gets cleared.

Reset parameters

Option	Description
Meter Initialization	Clears all data listed in this table.
Min/Max	Clears all the minimum and maximum registers.
Active Load Timer	Resets all active load timer logs.
Demands	Clears all the demand registers.
Peak Demands	Clears all the peak demand values.
Energies	Clears all accumulated energy values (kWh, kVARh, kVAh), and Run hours.
Digital Outputs	Clears all digital output values.
Digital Output Counters	Clears all the digital output counters.
Digital Output On Times	Clears all the digital output on time logs.
Status Input Counters	Clears all the input counters.
Status Input On Times	Clears all the input on time logs.
Alarm Counters	Clears all the alarm counters and alarm logs.
Data Log #1	Clears all the data logs.

Measurements and calculations

Real-time readings

The meter measures currents and voltages, and reports in real time the RMS (Root Mean Squared) values for all three phases and neutral.

The voltage and current inputs are continuously monitored at a sampling rate of 64 samples per cycle. This amount of resolution helps enable the meter to provide reliable measurements and calculated electrical values for various commercial, buildings and industrial applications.

Energy measurements

The meter provides fully bi-directional, 4-quadrant energy metering.

The meter stores all accumulated active, reactive and apparent energy measurements in nonvolatile memory:

- kWh, kVARh, kVAh (delivered)
- kWh, kVARh, kVAh (received)
- kWh, kVARh, kVAh net (delivered - received)
- kWh, kVARh, kVAh absolute (delivered + received)

All energy parameters represent the total for all three phases.

NOTE: Based on the energy scale selection, when kWh, kVARh, kVAh (delivered) or kWh, kVARh, kVAh (received) of the energy parameters overflow at 99999999.999 all energy parameters value resets.

Quadrant based VARh

NOTE: Applicable only for PM2120/PM2130 meter models.

Quadrant based reactive energy values are available only on communication. These reactive energies are for Q1, Q2, Q3, and Q4 quadrants.

On communication quadrant based reactive energies will be recorded as follows:

- Q1 (00 to 90 Degree) = Q1 VARh , Del
- Q2 (90 to 180 Degree) = Q2 VARh , Del
- Q3 (180 to 270 degree) = Q3 VARh, Rec
- Q4 (270 to 360 degree) = Q4 VARh , Rec

If energy is cleared, all quadrant based VARhs will be cleared.

Min/max values

When the readings reach their lowest or highest value, the meter updates and saves these min/max (minimum and maximum) quantities in non-volatile memory.

The meter's real-time readings are updated once every 50 cycles for 50 Hz systems, or once every 60 cycles for 60 Hz systems.

Power demand

Power demand is a measure of average power consumption over a fixed time interval.

NOTE: If not specified, references to demand are assumed to mean power demand.

The meter measures instantaneous consumption and can calculate demand using various methods.

Power demand calculation methods

Power demand is calculated by dividing the energy accumulated during a specified period by the length of that period.

How the meter performs this calculation depends on the method and time parameters you select (for example, timed rolling block demand with a 15-minute interval and 5-minute subinterval).

To be compatible with electric utility billing practices, the meter provides the following types of power demand calculations:

- Block interval demand
- Synchronized demand
- Thermal demand

You can configure the power demand calculation method from the display or software.

Block interval demand

For block interval demand method types, you specify a period of time interval (or block) that the meter uses for the demand calculation.

Select/configure how the meter handles that interval from one of these different methods:

Type	Description
Timed Sliding Block	Select an interval from 1 to 60 minutes (in 1-minute increments). If the interval is between 1 and 15 minutes, the demand calculation <i>updates every 15 seconds</i> . If the interval is between 16 and 60 minutes, the demand calculation <i>updates every 60 seconds</i> . The meter displays the demand value for the last completed interval.
Timed Block	Select an interval from 1 to 60 minutes (in 1-minute increments). The meter calculates and updates the demand at the end of each interval.
Timed Rolling Block	Select an interval and a subinterval. The subinterval must divide evenly into the interval (for example, three 5-minute subintervals for a 15-minute interval). Demand is <i>updated at the end of each subinterval</i> . The meter displays the demand value for the last completed interval.

Block interval demand example

The following illustration shows the different ways power demand is calculated using the block interval method. In this example, the interval is set to 15 minutes.

Timed Sliding Block

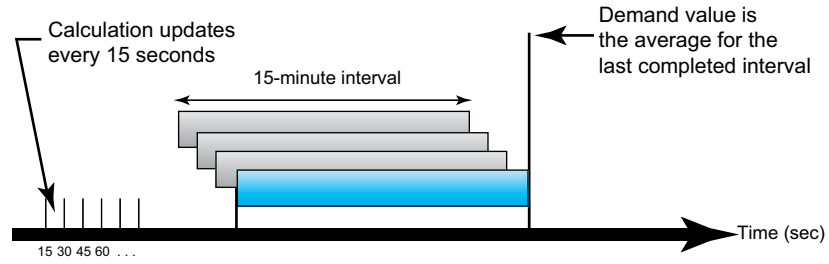

Timed Block

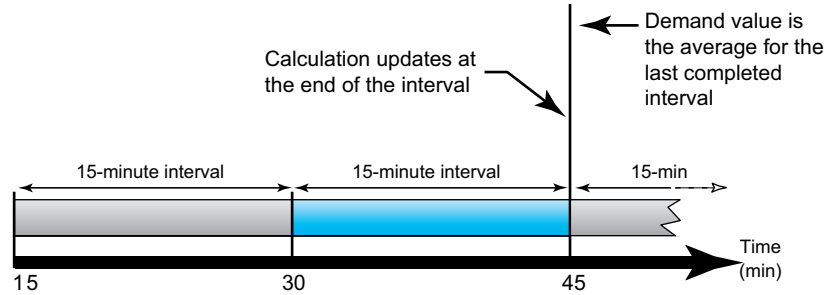

Timed Rolling Block

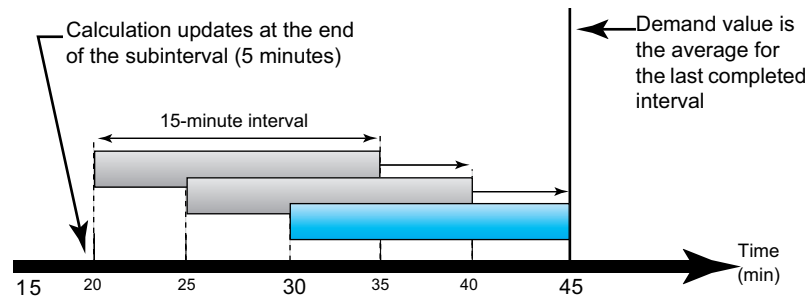

Synchronized demand

You can configure the demand calculations to be synchronized using an external pulse input, a command sent over communications, or the device’s internal real-time clock.

Type	Description
Command synchronized demand	This method allows you to synchronize the demand intervals of multiple meters on a communications network. For example, if a programmable logic controller (PLC) input is monitoring a pulse at the end of a demand interval on a utility revenue meter, you can program the PLC to issue a command to multiple meters whenever the utility meter starts a new demand interval. Each time the command is issued, the demand readings of each meter are calculated for the same interval.
Clock synchronized demand	This method allows you to synchronize the demand interval to the meter’s internal real-time clock. This helps you synchronize the demand to a particular time, typically on the hour (for example, at 12:00 am). If you select another time of day when the demand intervals are to be synchronized, the time must be specified in minutes from midnight. For example, to synchronize at 8:00 am, select 480 minutes.

NOTE: For these demand types, you can choose block or rolling block options. If you select a rolling block demand option, you need to specify a subinterval.

Thermal demand

Thermal demand calculates the demand based on a thermal response, which imitates the function of thermal demand meters.

The demand calculation updates at the end of each interval. You can set the demand interval from 1 to 60 minutes (in 1-minute increments).

Thermal demand example

The following illustration shows the thermal demand calculation. In this example, the interval is set to 15 minutes. The interval is a window of time that moves across the timeline. The calculation updates at the end of each interval.

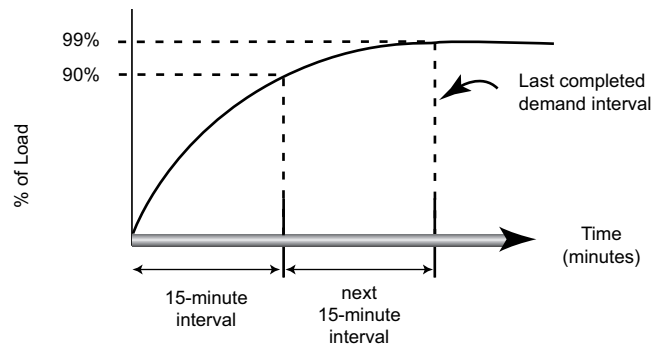

Current demand

The meter calculates current demand using the block interval, synchronized or thermal demand methods.

You can set the demand interval from 1 to 60 minutes in 1 minute increments (for example, 15 minutes).

Predicted demand

The meter calculates predicted demand for the end of the present interval for kW, kVAR, and kVA demand, taking into account the energy consumption so far within the present (partial) interval and the present rate of consumption.

Predicated demand is updated according to the update rate of your meter.

The following illustration shows how a change in load can affect predicted demand for the interval. In this example, the interval is set to 15 minutes.

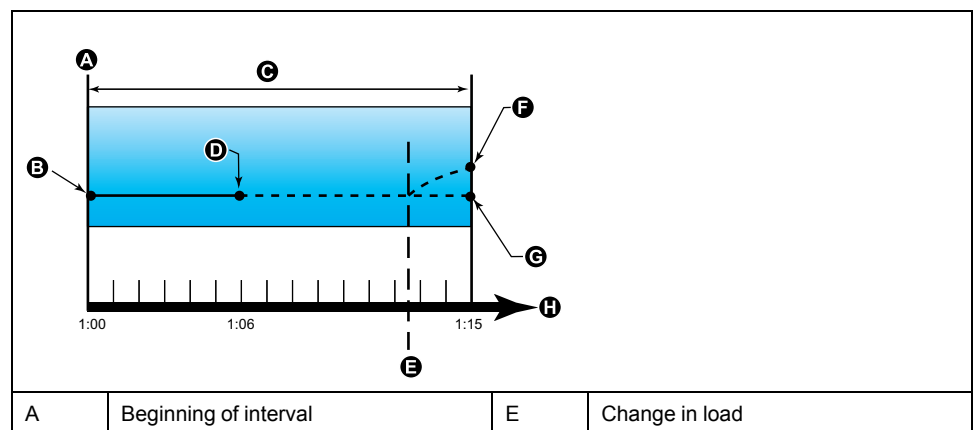

B	Demand for last completed interval	F	Predicted demand if load is added during interval; predicted demand increases to reflect increased demand
C	15-minute interval	G	Predicted demand if no load is added
D	Partial interval	H	Time

Peak demand

The meter records the peak (or maximum) values for kWd, kVARD, and kVAD power (or peak demand).

The peak for each value is the highest average reading since the meter was last reset. These values are maintained in the meter's non-volatile memory.

The meter also stores the date and time when the peak demand occurred.

Timer

The meter supports an active load timer, meter operation timer, and load run hours

Active load timer

Active load timer shows how much time a load has been running, based on the specified minimum current for the load timer setpoint setting.

The active load timer data can be read through communication only.

Meter operation timer

Meter operating timer shows how long the meter has been powered up.

Load run hours

Load run hours show how much time a load has been running, based on accumulated energy - received and delivered.

Load run hour counter is available under diag page. Run hours are displayed with 6 digits for Hours and 2 digits for Minutes. These run hour counters shall reset along with energy values.

Power quality

Harmonics overview

This section describes the meter's power quality features and how to access power quality data. The meter measures voltage and current harmonics up to the 15th harmonic and 31st harmonic, and calculates Total Harmonic Distortion (THD %).

Harmonics are integer multiples of the fundamental frequency of the power system. Harmonics information is required for compliance to system power quality standards such as EN50160 and meter power quality standards such as IEC 61000-4-30.

The meter measures fundamental and higher harmonics relative to the fundamental frequency. The meter's power system setting defines which phases are present and determines how line-to-line or line-to-neutral voltage harmonics and current harmonics are calculated.

Harmonics are used to identify whether the supplied system power meets required power quality standards, or if non-linear loads are affecting your power system. Power system harmonics can cause current flow on the neutral conductor, and damage to equipment such as increased heating in electric motors. Power conditioners or harmonic filters can be used to minimize unwanted harmonics.

Total harmonic distortion %

Total harmonic distortion (THD%) is a measure of the total per-phase voltage or current harmonic distortion present in the power system.

THD% provides a general indication of the quality of a waveform. THD% is calculated for each phase of both voltage and current.

Harmonic content calculations

Harmonic content (H_C) is equal to the RMS value of all the non-fundamental harmonic components in one phase of the power system.

The meter uses the following equation to calculate H_C :

$$H_C = \sqrt{(H_2)^2 + (H_3)^2 + (H_4)^2 \dots}$$

THD% calculations

THD% is a quick measure of the total distortion present in a waveform and is the ratio of harmonic content (H_C) to the fundamental harmonic (H_1).

By default, the meter uses the following equation to calculate THD%:

$$THD = \frac{H_C}{H_1} \times 100\%$$

Displaying harmonics data

The meter displays voltage and current THD% data on the front panel, while the phase wise THD% data can be read through communication.

1. Press OK button to navigate to phase parameters.
2. Press Down button to view V_{THD} and I_{THD} values.

NOTE:

The LED rows display $V1_{THD}$, $V2_{THD}$, and $V3_{THD}$ for V_{THD} values, and $A1_{THD}$, $A2_{THD}$, and $A3_{THD}$ for I_{THD} values.

Maintenance and upgrades

Maintenance overview

The meter does not contain any user-serviceable parts. If the meter requires service, contact your local Schneider Electric Technical Support representative.

NOTICE
<p>METER DAMAGE</p> <ul style="list-style-type: none"> • Do not open the meter case. • Do not attempt to repair any components of the meter. <p>Failure to follow these instructions can result in equipment damage.</p>

Do not open the meter. Opening the meter voids the warranty.

Troubleshooting LED indicators

Abnormal heartbeat / serial communications LED behavior could mean potential problems with the meter.

Problem	Probable causes	Possible solutions
LED flash rate does not change when data is sent from the host computer.	Communications wiring	If using a serial-to-RS-485 converter, trace and check that all wiring from the computer to the meter is properly terminated.
	Internal hardware problem	Perform a hard reset: turn off control power to the meter, then re-apply power. If the problem persists, contact Technical Support.
Heartbeat / serial communications LED remains lit and does not flash ON and OFF	Internal hardware problem	Perform a hard reset: turn off control power to the meter, then re-apply power. If the problem persists, contact Technical Support.
Heartbeat / serial communications LED flashes, but the display is blank.	Display setup parameters incorrectly set	Review display parameter setup.

If the problem is not fixed after troubleshooting, contact Technical Support for help and ensure you have your meter’s firmware version, model and serial number information available.

Meter memory

The meter stores configuration and logging information in non-volatile memory and a long-life memory chip.

The meter uses its non-volatile memory (NVRAM) to retain all data and metering configuration values.

Meter battery

The internal battery in the meter keeps the meter's clock running when it is powered down to help maintain the meter time.

The life expectancy of the meter's internal battery is estimated to be over 10 years at 25 °C under typical operating conditions.

Viewing firmware version, model and serial number

You can view the meter's firmware version, model and serial number from the display panel.

1. Press and hold Down and OK button for 2 seconds to enter Diag page. Meter display shows all LEDs turned on.
2. Press Down button to view meter model, serial number, OS version, and RS version.
3. Press and hold Down and OK button for 2 seconds to exit Diag page.

Firmware upgrades

There are a number of reasons why you may want to upgrade your meter's firmware.

- Improve meter performance (e.g., optimize processing speed)
- Enhance existing meter features and functions
- Add new functionality to the meter
- Achieve compliance to new industry standards

Technical assistance

Make sure you include your meter's model, serial number and firmware version in your email or have it readily available if calling Technical Support.

Verifying accuracy

Overview of meter accuracy

All meters are tested and verified at the factory in accordance with International Electrotechnical Commission (IEC) and Institute of Electrical and Electronics Engineers (IEEE) standards.

Your meter typically does not require re-calibration. However, in some installations a final accuracy verification of the meters is required, especially if the meters will be used for revenue or billing applications.

Accuracy test requirements

The most common method for testing meter accuracy is to apply test voltages and currents from a stable power source and compare the meter's readings with readings from a reference device or energy standard.

Signal and power source

The meter maintains its accuracy during voltage and current signal source variations but its energy pulsing output needs a stable test signal to help produce accurate test pulses. The meter's energy pulsing mechanism needs approximately 10 seconds to stabilize after every source adjustment.

The meter must be connected to control power in order to conduct accuracy verification testing. Refer to your meter's installation documentation for power supply specifications.

DANGER

HAZARD OF ELECTRIC SHOCK, EXPLOSION, OR ARC FLASH

Verify the device's power source meets the specifications for your device's power supply.

Failure to follow these instructions will result in death or serious injury.

Control equipment

Control equipment is required for counting and timing the pulse outputs from an energy pulsing LED.

- Most standard test benches have an arm equipped with optical sensors to detect LED pulses (the photodiode circuitry converts detected light into a voltage signal).
- The reference device or energy standard typically has digital inputs that can detect and count pulses coming from an external source (i.e., the meter's pulse output).

NOTE: The optical sensors on the test bench can be disrupted by strong sources of ambient light (such as camera flashes, florescent tubes, sunlight reflections, floodlights, etc.). This can cause test errors. Use a hood, if necessary, to block out ambient light.

Environment

The meter should be tested at the same temperature as the testing equipment. The ideal temperature is about 23 °C (73 °F). Make sure the meter is warmed up sufficiently before testing.

A warm-up time of 30 minutes is recommended before beginning energy accuracy verification testing. At the factory, the meters are warmed up to their typical operating temperature before calibration to help ensure that the meters will reach their optimal accuracy at operating temperature.

Most high precision electronic equipment requires a warm up time before it reaches its specified performance levels. Energy meter standards allow the manufacturers to specify meter accuracy derating due to ambient temperature changes and self-heating.

Your meter complies with and meets the requirements of these energy metering standards.

For a list of accuracy standards that your meter complies to, contact your local Schneider Electric representative or download the meter brochure from www.se.com.

Reference device or energy standard

To help ensure the accuracy of the test, it is recommended that you use a reference device or reference energy standard with a specified accuracy that is 6 to 10 times more accurate than the meter under test. Before you start testing, the reference device or energy standard should be warmed up as recommended by its manufacturer.

NOTE: Verify the accuracy and precision of all measurement equipment used in accuracy testing (for example, voltmeters, ammeters, power factor meters).

Verifying accuracy test

The following tests are guidelines for accuracy testing your meter; your meter shop may have specific testing methods.

DANGER

HAZARD OF ELECTRIC SHOCK, EXPLOSION, OR ARC FLASH

- Apply appropriate Personal Protective Equipment (PPE) and follow safe electrical work practices. See NFPA 70E, CSA Z462 or other local standards.
- Turn off all power supplying this device and the equipment in which it is installed before working on or in the equipment.
- Always use a properly rated voltage sensing device to confirm that all power is off.
- Do not exceed the maximum ratings of this device.
- Verify the device's power source meets the specifications for your device's power supply.

Failure to follow these instructions will result in death or serious injury.

1. Turn off all power supplying this device and the equipment in which it is installed before working on the device or equipment.
2. Use a properly rated voltage sensing device to confirm that all power is off.

3. Connect the test voltage and current source to the reference device or energy standard. Ensure all voltage inputs to the meter under test are connected in parallel and all current inputs are connected in series.

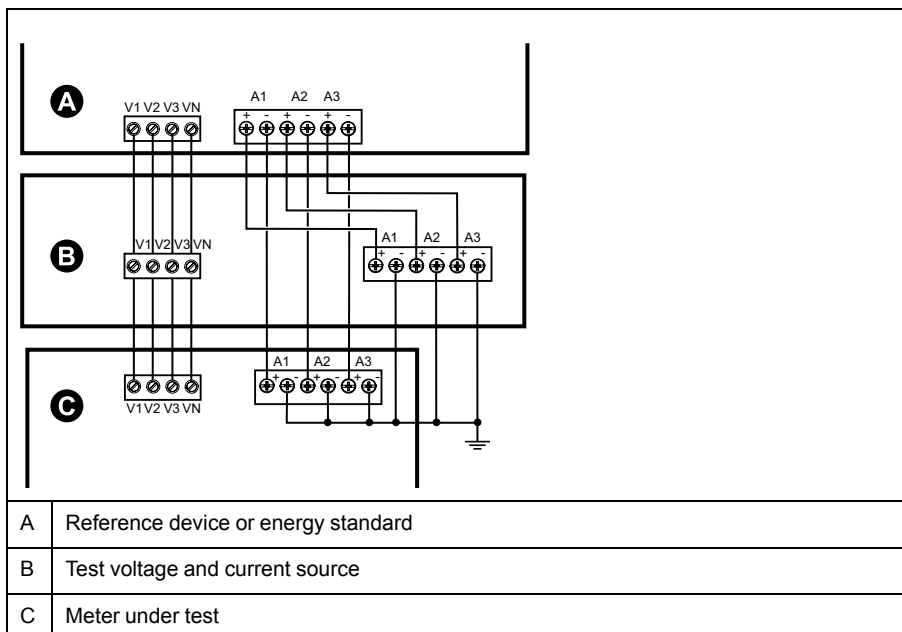

4. Connect the control equipment used for counting the standard output pulses using one of these methods:

Option	Description
Energy pulsing LED	Align the red light sensor on the standard test bench armature over the energy pulsing LED.
Pulse output	Connect the meter's pulse output to the standard test bench pulse counting connections.

NOTE: When selecting which method to use, be aware that energy pulsing LEDs and pulse outputs have different pulse rate limits.

5. Before performing the verification test, let the test equipment power up the meter and apply voltage for at least 30 seconds. This helps stabilize the internal circuitry of the meter.
6. Configure the meter's parameters for verifying accuracy testing.
7. Depending on the method selected for counting the energy pulses, configure the meter's energy pulsing LED or one of the pulse outputs to perform energy pulsing. Set the meter's energy pulse constant so it is in sync with the reference test equipment.
8. Perform accuracy verification on the test points. Run each test point for at least 30 seconds to allow the test bench equipment to read an adequate number of pulses. Allow 10 seconds of dwell time between test points.

Required pulses calculation for accuracy verification testing

Accuracy verification test equipment typically requires you to specify the number of pulses for a specific test duration.

The reference test equipment typically requires you to specify the number of pulses required for a test duration of "t" seconds. Normally, the number of pulses required is at least 25 pulses, and the test duration is greater than 30 seconds.

Use the following formula to calculate the required number of pulses:

$$\text{Number of pulses} = P_{\text{tot}} \times K \times t / 3600$$

Where:

- P_{tot} = total instantaneous power in kilowatts (kW)
- K = the meter's pulse constant setting, in pulses per kWh
- t = test duration, in seconds (typically greater than 30 seconds)

Total power calculation for accuracy verification testing

Accuracy verification testing supplies the same test signal (total power) to both the energy reference/standard and the meter under test.

Total power is calculated as follows, where:

- P_{tot} = total instantaneous power in kilowatts (kW)
- V_{LN} = test point line-to-neutral voltage in volts (V)
- I = test point current in amps (A)
- PF = power factor

The result of the calculation is rounded up to the nearest integer.

For a balanced 3-phase Wye system:

$$P_{\text{tot}} = 3 \times V_{\text{LN}} \times I \times PF \times 1 \text{ kW}/1000 \text{ W}$$

NOTE: A balanced 3-phase system assumes that the voltage, current and power factor values are the same for all phases.

For a single-phase system:

$$P_{\text{tot}} = V_{\text{LN}} \times I \times PF \times 1 \text{ kW}/1000 \text{ W}$$

Percentage error calculation for accuracy verification testing

Accuracy verification testing requires you to calculate the percentage error between the meter being tested and the reference/standard.

Calculate the percentage error for every test point using the following formula:

$$\text{Energy error} = (EM - ES) / ES \times 100\%$$

Where:

- EM = energy measured by the meter under test
- ES = energy measured by the reference device or energy standard.

NOTE: If accuracy verification reveals inaccuracies in your meter, they may be caused by typical sources of test errors. If there are no sources of test errors present, please contact your local Schneider Electric representative.

Accuracy verification test points

The meter should be tested at full and light loads and at lagging (inductive) power factors to help ensure testing over the entire range of the meter.

The test amperage and voltage input rating are labeled on the meter. Refer to the installation sheet or data sheet for your meter's nominal current, voltage and frequency specifications.

Watt-hour test point	Sample accuracy verification test point
Full load	100% to 200% of the nominal current, 100% of the nominal voltage and nominal frequency at unity power factor or one (1).
Light load	10% of the nominal current, 100% of the nominal voltage and nominal frequency at unity power factor or one (1).
Inductive load (lagging power factor)	100% of the nominal current, 100% of the nominal voltage and nominal frequency at 0.50 lagging power factor (current lagging voltage by 60° phase angle).

VAR-hour test point	Sample accuracy verification test point
Full load	100% to 200% of the nominal current, 100% of the nominal voltage and nominal frequency at zero power factor (current lagging voltage by 90° phase angle).
Light load	10% of the nominal current, 100% of the nominal voltage and nominal frequency at zero power factor (current lagging voltage by 90° phase angle).
Inductive load (lagging power factor)	100% of the nominal current, 100% of the nominal voltage and nominal frequency at 0.87 lagging power factor (current lagging voltage by 30° phase angle).

Energy pulsing considerations

The meter's energy pulsing LED and pulse outputs are capable of energy pulsing within specific limits.

Description	Energy pulsing LED	Pulse output
Maximum pulse frequency	35 Hz	20 Hz
Minimum pulse constant	1 pulse per k_h	
Maximum pulse constant	9,999,000 pulses per k_h	

The pulse rate depends on the voltage, current and PF of the input signal source, the number of phases, and the VT and CT ratios.

If P_{tot} is the instantaneous power (in kW) and K is the pulse constant (in pulses per kWh), then the pulse period is:

$$\text{Pulse period (in seconds)} = \frac{3600}{K \times P_{\text{tot}}} = \frac{1}{\text{Pulse frequency (Hz)}}$$

VT and CT considerations

Total power (P_{tot}) is derived from the values of the voltage and current inputs at the secondary side, and takes into account the VT and CT ratios.

The test points are always taken at the secondary side, regardless of whether VTs or CTs are used.

If VTs and CTs are used, you must include their primary and secondary ratings in the equation. For example, in a balanced 3-phase Wye system with VTs and CTs:

$$P_{\text{tot}} = 3 \times V_{\text{LN}} \times \frac{V_{\text{T}_p}}{V_{\text{T}_s}} \times I \times \frac{C_{\text{T}_p}}{C_{\text{T}_s}} \times \text{PF} \times \frac{1 \text{ kW}}{1000 \text{ W}}$$

where P_{tot} = total power, V_{T_p} = VT primary, V_{T_s} = VT secondary, C_{T_p} = CT primary, C_{T_s} = CT secondary and PF = power factor.

Example calculations

This example calculation shows how to calculate power, pulse constants and maximum pulse frequency, and how to determine a pulse constant that reduces the maximum pulse frequency.

A balanced 3-phase Wye system uses 480:120 volt VTs and 120:5 amp CTs. The signals at the secondary side are 119 volts line-to-neutral and 5.31 amps, with a power factor of 0.85. The desired pulse output frequency is 20 Hz (20 pulses per second).

1. Calculate the typical total output power (P_{tot}):

$$P_{tot} = 3 \times 119 \times \frac{480}{120} \times 5.31 \times \frac{120}{5} \times 0.85 \times \frac{1 \text{ kW}}{1000 \text{ W}} = 154.71 \text{ kW}$$

2. Calculate the pulse constant (K):

$$K = \frac{3600 \times (\text{pulse frequency})}{P_{tot}} = \frac{3600 \text{ seconds/hour} \times 20 \text{ pulses/second}}{154.71 \text{ kW}}$$

$$K = 465.5 \text{ pulses / kWh}$$

3. At full load (120% of nominal current = 6 A) and power factor (PF = 1), calculate the maximum total output power (P_{max}):

$$P_{max} = 3 \times 119 \times \frac{480}{120} \times 6 \times \frac{100}{5} \times 1 \times \frac{1 \text{ kW}}{1000 \text{ W}} = 205.6 \text{ kW}$$

4. Calculate the maximum output pulse frequency at P_{max}:

$$\text{Maximum pulse frequency} = \frac{K \times P_{max}}{3600} = \frac{465.5 \text{ pulses / kWh} \times 205.6 \text{ kW}}{3600 \text{ seconds/hour}}$$

$$\text{Maximum pulse frequency} = 26.6 \text{ pulses/second} = 26.6 \text{ Hz}$$

5. Check the maximum pulse frequency against the limits for the LED and pulse outputs:

- 26.6 Hz ≤ LED maximum pulse frequency (35 Hz)
- 26.6 Hz > pulse output maximum pulse frequency (20 Hz)

NOTE: The maximum pulse frequency is within the limits for LED energy pulsing. However, the maximum pulse frequency is greater than the limits for pulse output energy pulsing. Pulse output frequencies greater than 20 Hz will saturate the pulse output and cause it to stop pulsing. Therefore in this example, you can only use the LED for energy pulsing.

Adjustments to allow energy pulsing at the pulse outputs

If you want to use the pulse output, you must reduce the output pulse frequency so it is within the limits.

Using the values from the above example, the maximum pulse constant for the pulse output is:

$$K_{max} = \frac{3600 \times (\text{pulse output maximum pulse frequency})}{P_{max}} = \frac{3600 \times 20}{205.6}$$

$$K_{max} = 350.14 \text{ pulses per kWh}$$

1. Set the pulse constant (K) to a value below Kmax, for example, 300 pulses/kWh. Calculate the new maximum output pulse frequency at Pmax:

$$\text{New maximum pulse frequency} = \frac{K \times P_{\text{max}}}{3600} = \frac{300 \text{ pulses/kWh} \times 205.6 \text{ kW}}{3600 \text{ seconds/hour}}$$

$$\text{New maximum pulse frequency} = 17.1 \text{ pulses/second} = 17.1 \text{ Hz}$$

2. Check the new maximum pulse frequency against the limits for the LED and pulse outputs:
 - $17.1 \text{ Hz} \leq \text{LED maximum pulse frequency (35 Hz)}$
 - $17.1 \text{ Hz} \leq \text{pulse output maximum frequency (20 Hz)}$

As expected, changing K to a value below Kmax allows you to use the pulse output for energy pulsing.

3. Set the new pulse constant (K) on your meter.

Typical sources of test errors

If you see excessive errors during accuracy testing, examine your test setup and test procedures to eliminate typical sources of measurement errors.

Typical sources of accuracy verification testing errors include:

- Loose connections of voltage or current circuits, often caused by worn-out contacts or terminals. Inspect terminals of test equipment, cables, test harness and the meter under test.
- Meter ambient temperature is significantly different than 23 °C (73 °F).
- Floating (ungrounded) neutral voltage terminal in any configuration with unbalanced phase voltages.
- Inadequate meter control power, resulting in the meter resetting during the test procedure.
- Ambient light interference or sensitivity issues with the optical sensor.
- Unstable power source causing energy pulsing fluctuations.
- Incorrect test setup: not all phases connected to the reference device or the energy standard. All phases connected to the meter under test should also be connected to the reference meter/standard.
- Moisture (condensing humidity), debris or pollution present in the meter under test.

Power and power factor

Power and power factor

The sampled measurements taken at the meter’s voltage and current inputs provide data for calculating power and power factor.

In a balanced 3-phase alternating current (AC) power system source, the AC voltage waveforms on the current-carrying conductors are equal but offset by one-third of a period (a phase angle shift of 120 degrees between the three voltage waveforms).

Current phase shift from voltage

Electrical current can lag, lead, or be in phase with the AC voltage waveform, and is typically associated with the type of load — inductive, capacitive or resistive.

For purely resistive loads, the current waveform is in phase with the voltage waveform. For capacitive loads, current leads voltage. For inductive loads, current lags voltage.

The following diagrams show how voltage and current waveforms shift based on load type under ideal (laboratory) conditions.

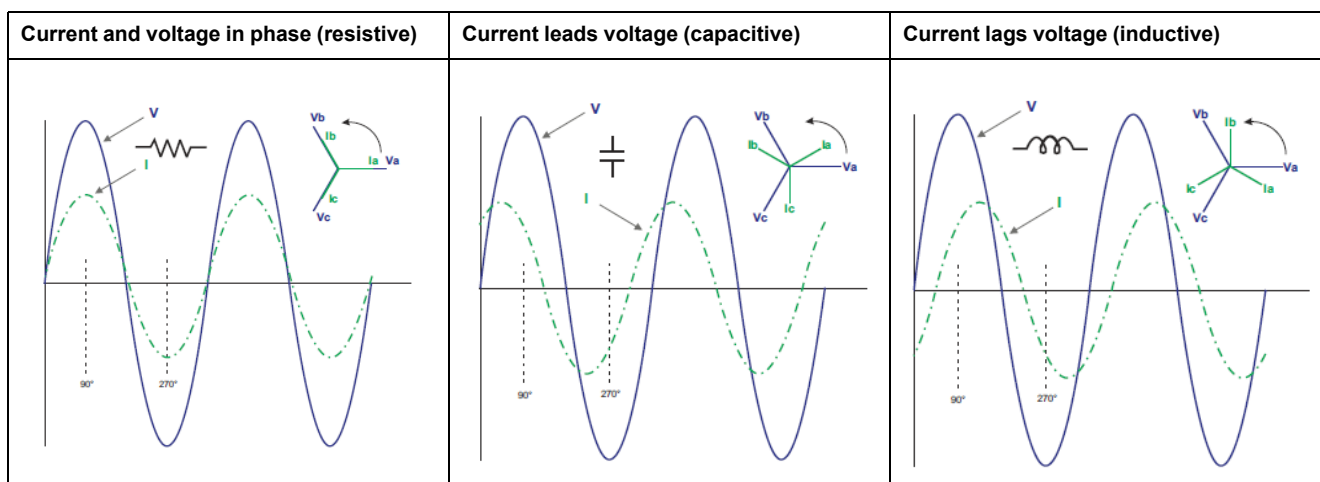

Real, reactive and apparent power (PQS)

A typical AC electrical system load has both resistive and reactive (inductive or capacitive) components.

Real power, also known as active power (P) is consumed by resistive loads. Reactive power (Q) is either consumed by inductive loads or generated by capacitive loads.

Apparent power (S) is the capacity of your measured power system to provide real and reactive power.

The units for power are watts (W or kW) for real power P, vars (VAR or kVAR) for reactive power Q, and volt-amps (VA or kVA) for apparent power S.

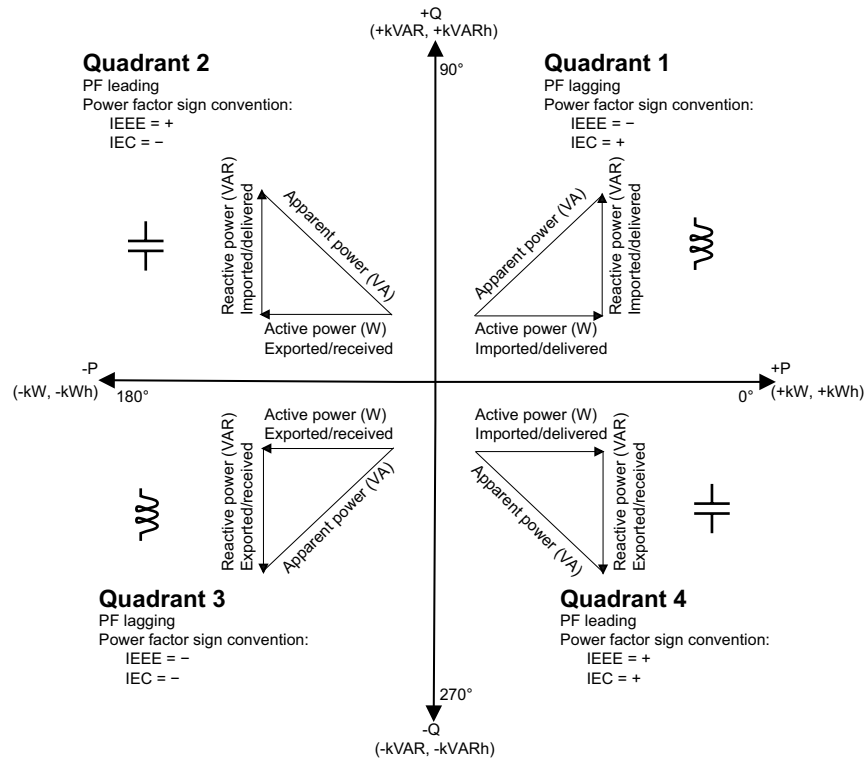

Power flow

Positive real power P(+) flows from the power source to the load. Negative real power P(-) flows from the load to the power source.

Power factor (PF)

Power factor (PF) is the ratio of real power (P) to apparent power (S).

PF is provided as a number between -1 and 1 or as a percentage from -100% to 100%, where the sign is determined by the convention.

$$PF = \frac{P}{S}$$

A purely resistive load has no reactive components, so its power factor is 1 (PF = 1, or unity power factor). Inductive or capacitive loads introduce a reactive power (Q) component to the circuit which causes the PF to become closer to zero.

True PF and displacement PF

The meter supports true power factor and displacement power factor values:

- True power factor includes harmonic content.
- Displacement power factor only considers the fundamental frequency.

NOTE: Unless specified, the power factor displayed by the meter is true power factor.

Power factor sign convention

Power factor sign (PF sign) can be positive or negative, and is defined by the conventions used by the IEEE or IEC standards.

You can set the power factor sign (PF sign) convention that is used on the display to either IEC or IEEE.

PF sign convention: IEC

PF sign correlates with the direction of real power (kW) flow.

- Quadrant 1 and 4: Positive real power (+kW), the PF sign is positive (+).
- Quadrant 2 and 3: Negative real power (-kW), the PF sign is negative (-).

PF sign convention: IEEE

PF sign is correlates with the PF lead/lag convention, in other words, the effective load type (inductive or capacitive):

- For a capacitive load (PF leading, quadrant 2 and 4), the PF sign is positive (+).
- For an inductive load (PF lagging, quadrant 1 and 3), the PF sign is negative (-).

PF value display

First digit of PF value indicates the Lag and Lead.

Lag is indicated by "i" and Lead is indicated by "c" for first digit of PF value.

NOTE: "i" = Inductive load/Lag PF and "c" = capacitive load/Lead PF.

NOTE: Without the load, the PF value is displayed as " - - - - "

Sample screen



Power factor min/max convention

The meter uses a specific convention for determining the power factor minimum and maximum values.

- For negative PF readings, the minimum PF value is the measurement closest to -0 for PF readings between -0 to -1. For positive PF readings, the minimum PF value is the measurement closest to +1 for PF readings between +1 to +0.
- For negative PF readings, the maximum PF value is the measurement closest to -1 for PF readings between -0 to -1. For positive PF readings, the maximum PF value is the measurement closest to +0 for PF readings between +1 to +0.

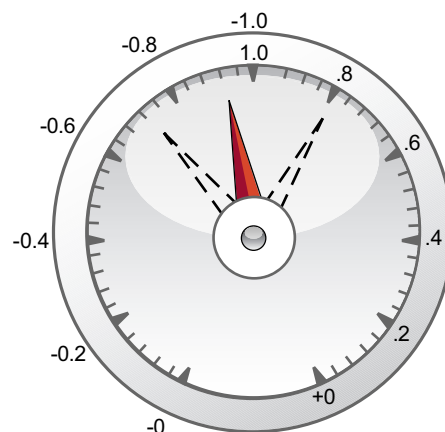

Power factor register format

The meter performs a simple algorithm to the PF value then stores it in the PF register.

Each power factor value (PF value) occupies one floating point register for power factor (PF register). The meter and software interpret the PF register for all reporting or data entry fields according to the following diagram:

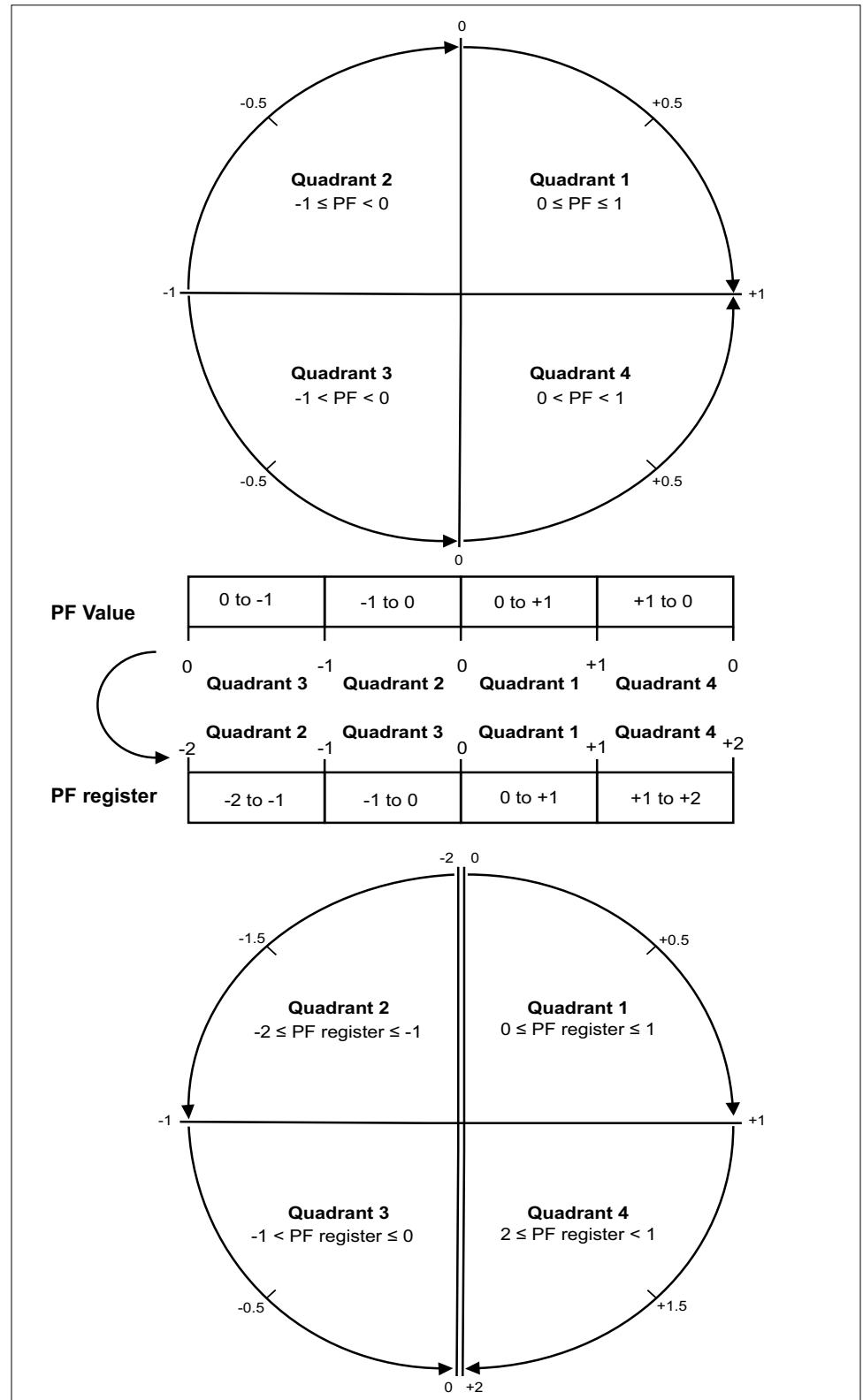

The PF value is calculated from the PF register value using the following formulae:

Quadrant	PF range	PF register range	PF formula
Quadrant 1	0 to +1	0 to +1	PF value = PF register value
Quadrant 2	-1 to 0	-2 to -1	PF value = (-2) - (PF register value)

Quadrant	PF range	PF register range	PF formula
Quadrant 3	0 to -1	-1 to 0	PF value = PF register value
Quadrant 4	+1 to 0	+1 to +2	PF value = (+2) - (PF register value)

Specifications

The specifications contained in this section are subject to change without notice.

For installation and wiring information, refer to the meter installation sheet.

Mechanical characteristics

IP degree of protection (IEC 60529-1)	Front display: IP54 (Upgrade to IP65 with optional accessory kit METSEIP65OP96X96FF) Meter body: IP30
Panel thickness maximum	6.0 mm (0.25 in) maximum
Mounting position	Vertical
Display type	LED display — 7 Segment
Keypad	3 button
Front panel LED indicators	Green LED (heartbeat / serial communications activity) Red LED (alarm / energy pulse output)
Weight	~ 300 gms
Dimensions W x H x D	96 x 96 x 73 mm max
Relay	2 Form A electro-mechanical relay (PM2130 only)

Electrical characteristics

Measurement accuracy – PM2110 and PM2120

- IEC 61557-12: PMD/[SD|SS]/K70/1 (for firmware version 1.3.0 and higher)

Measurement type	Class of accuracy as per IEC 61557-12 (for firmware version 1.3.0 and higher)	Error
Active energy	Class 1 (Class 1 as per IEC 62053-21 at $I_n = 5A$ nominal CT)	±1%
Reactive energy	Class 2 (Class 2 as per IEC 62053-23 at $I_n = 5A$ nominal CT)	±1%
Apparent energy	Class 1 at $I_n = 5A$ nominal CT	±1%
Active power	Class 1	±1%
Reactive power	Class 1	±1%
Apparent power	Class 1	±1%
Current	Class 1	±0.5%
Voltage (L-L)	Class 1	±0.5%
Voltage (L-N)	Class 1	±0.5%
Frequency	Class 1	±0.05%
Power factor	Class 1	±0.01 Count
THD and individual harmonics	Class 5	±5%

Measurement accuracy – PM2130

- IEC 61557-12: PMD/[SD|SS]/K70/0.5 (for firmware version 1.3.0 and higher)

Measurement type	Class of accuracy as per IEC 61557-12 (for firmware version 1.3.0 and higher)	Error
Active energy	Class 0.5S (Class 0.5S as per IEC 62053-22 at $I_n = 5A$ nominal CT ²)	±0.5%

2. For 1 A CT nominal, additional error of ±1 % from 50 mA to 150 mA, ±2 % for current > 10 mA to < 50 mA. Partial standard compliance for Class 0.5S meter type (energy test clause only)

Measurement accuracy – PM2130 (Continued)

Reactive energy	Class 2 (Class 2 as per IEC 62053-23 at $I_n = 5A$ nominal CT)	±1%
Apparent energy	Class 0.5 at $I_n = 5A$ nominal CT	±0.5%
Active power	Class 0.5	±0.5%
Reactive power	Class 1	±1%
Apparent power	Class 0.5	±0.5%
Current	Class 0.5	±0.2%
Voltage (L-L)	Class 0.5	±0.2%
Voltage (L-N)	Class 0.5	±0.2%
Frequency	Class 0.05	±0.05%
Power factor	Class 0.5	±0.01 Count
THD and individual harmonics	Class 5	±5%

Voltage inputs

Parameter	Range
VT primary	999 kV L-L max, starting voltage depends on VT ratio
V nominal	277 V L-N / 480 V L-L
Measured V with full range	35 - 480 V L-L (20 - 277 V L-N), CAT III 35 - 600 V L-L (20 - 347 V L-N), CAT II
Permanent overload	750 V AC L-L
Impedance	≥ 5 MΩ
Frequency	50 / 60 Hz nominal ± 5%
VA burden	< 0.2 VA at 240 V AC L-N

Current inputs

Parameter	Range
CT ratings	Primary adjustable 1 A to 32767 A Secondary 1 A or 5 A I-nominal
Measured current	5 mA to 6 A
Suppression current (to disregard negligible load)	5 mA to 99 mA
Withstand	Continuous 12 A; 50 A at 10 sec/hr, 500 A at 1 sec/hr
Impedance	< 0.3 mΩ
Frequency	50 / 60 Hz nominal
VA Burden	< 0.024 VA at 6 A

AC control power - PM2110 / PM2120

Parameter	Range
Operating range	44 - 277 V L-N ± 10%
Burden	< 6 VA at 277 V L-N
Frequency range	45 - 65 Hz
Ride-through time	100 ms at 120 V AC 400 ms at 230 V AC

AC control power - PM2130

Parameter	Range
Operating range	80 - 277 V L-N \pm 10%
Burden	< 8 VA at 277 V L-N
Frequency range	45 - 65 Hz
Ride-through time	100 ms at 120 V AC (standalone device) 50 ms at 120 V AC with IO modules 400 ms at 230 V AC (standalone device) 250 ms at 230 V AC with IO modules

DC control power - PM2110/PM2120

Parameter	Range
Operating range	48 - 277 V DC \pm 10%
Burden	< 2 W at 277 V DC
Ride-through time	50 ms at 125 V DC

DC control power - PM2130

Parameter	Range
Operating range	100 - 277 V DC \pm 10%
Burden	< 3.3 W at 277 V DC
Ride-through time	100 ms at 125 V DC (standalone device) 50 ms at 125 V DC with IO modules

Displays update

Parameter	Range
Instantaneous	1 s
Demand	15 s
Harmonics	5 s

Wiring configuration

User programmable	Configuration through both HMI and ION setup	Configuration through only ION setup
	1ph 2W, L-N 1ph 2W, L-L 1ph 3W, L-L with N (2 phase) 3ph 3W, Delta, Ungrounded 3ph 4W, Wye Grounded	3ph 3W, Delta, Corner Grounded 3ph 3W, Wye, Ungrounded 3ph 3W, Wye Grounded 3ph 3W, Wye, Resistance Grounded 3ph 4W, Open Delta, Center-Tapped 3ph 4W, Delta, Center-Tapped 3ph 4W, Wye, Ungrounded 3ph 4W, Wye, Resistance Grounded

Digital I/O - PM2130

Parameter	Range
Isolation	2.5 kV RMS
Digital (Status) Input	
Voltage ratings	ON 18 to 36 V DC

Digital I/O - PM2130 (Continued)

Parameter	Range
	OFF 0 to 4 V DC
Digital Output	
Load voltage	≤ 40 V DC
Load current	≤ 20 mA
On resistance	≤ 50 Ω
Pulse duration for digital output ³	[20, 25, 50, 100] ms

Analog I/O - PM2130

Parameter	Range
Update rate	1 s
Analog Input	
Measurement scale	4-20 mA
Maximum source impedance	> 500 Ω
Analog Output	
Measurement scale	4-20 mA
Load impedance	≤ 600 Ω

Relay - PM2130

Parameter	Range
Voltage ratings	250 V AC / 2A
	24 V DC / 2A
Output frequency	0.5 Hz maximum (1 second ON / 1 second OFF)
Switching current	5A, 250 V AC / 30 V DC (cos φ=1), 100 k cycles
	2A, 250 V AC / 30 V DC (cos φ=0.4), 100 k cycles
	500 mA, 250 V AC / 30 V DC , 1 M cycles
Whetting Voltage	24V DC / 8 mA maximum

Environmental characteristics

Operating temperature	-10 °C to +60 °C (14 °F to 140 °F)
Storage temperature	-25 °C to +70 °C (-13 °F to 158 °F)
Humidity rating	5% to 95% RH at 50 °C (122 °F) (non-condensing)
Pollution degree	2
Altitude	≤ 2000 m (6562 ft)
Location	Not suitable for wet locations
Product life	> 7 years

EMC (electromagnetic compatibility)⁺³

Electrostatic discharge	IEC 61000-4-2
Immunity to radiated field	IEC 61000-4-3

3. Indicates the feature is configurable through communication.

Immunity to fast transients	IEC 61000-4-4
Immunity to impulse waves	IEC 61000-4-5
Conducted immunity	IEC 61000-4-6
Immunity to magnetic field	IEC 61000-4-8
Immunity to voltage dips	IEC 61000-4-11
Emissions (IEC61326-1)	CIPR 22 Class A FCC Part 15 Class A

+3 Tested as per IEC 61326-1 standard

Safety

Europe	CE, as per IEC 61010-1 Ed-3 and IEC 613261 - 1
US and Canada	cULus per UL 61010-1 CAN / CSA-C22.2 No. 61010-1, for 600 V AC
Measurement category (Voltage and Current inputs)	CAT III up to 480 V L-L CAT II up to 600 V L-L
Overvoltage category (Control power)	CAT III up to 277 V L-N ± 10%
Dielectric	As per IEC / UL 61010-1 Ed-3
Protective Class	II, Double insulated for user accessible parts
Other certification	RCM

RS-485 communications

Number of ports	1
Maximum cable length	1000 m (3280 ft)
Maximum number of devices (unit loads)	Up to 32 devices on the same bus
Parity	Even, Odd, None (1 stop bit for Odd or Even parity; 2 stop bits for None)
Baud rate	4800, 9600, 19200, 38400
Isolation	2.5 kV RMS, double insulated

Pulse output

Pulse output (POP)	Max 40 V DC, 20 mA Configurable pulse weight from 1 to 9999000 pulse / k_h (kWh, kVAh, or kVARh)
--------------------	---

Real-time clock

Battery backup time	3 years NOTE: When date and time is configured, and meter is in off state.
---------------------	--

China Standard Compliance

This product complies with the following standard(s) in China:

PM2110 / PM2120

IEC 61010-1:2010 Safety requirements for electrical equipment for measurement, control, and laboratory use - Part 1: General requirements

PM2130

IEC 61557-12:2018 Electrical safety in low voltage distribution systems up to 1 000 V AC and 1 500 V DC - Equipment for testing, measuring or monitoring of protective measures - Part 12: Power metering and monitoring devices (PMD)

Schneider Electric
35 rue Joseph Monier
92500 Rueil Malmaison
France

+ 33 (0) 1 41 29 70 00

www.se.com

As standards, specifications, and design change from time to time,
please ask for confirmation of the information given in this publication.

© 2022 – Schneider Electric. All rights reserved.

NHA2779002-10